

170330-1 ✓ ACTIVE

Positive Lock | Mark II, Positive Lock 187

TE Internal #: 170330-1

Quick Disconnects, Receptacle, 24 – 20 AWG Wire Size, .2 – .51 mm² Wire Size, Mating Tab Width 4.75 mm [.187 in], Straight, Brass, Positive Lock 187

[View on TE.com >](#)



Terminals & Splices > Quick Disconnects

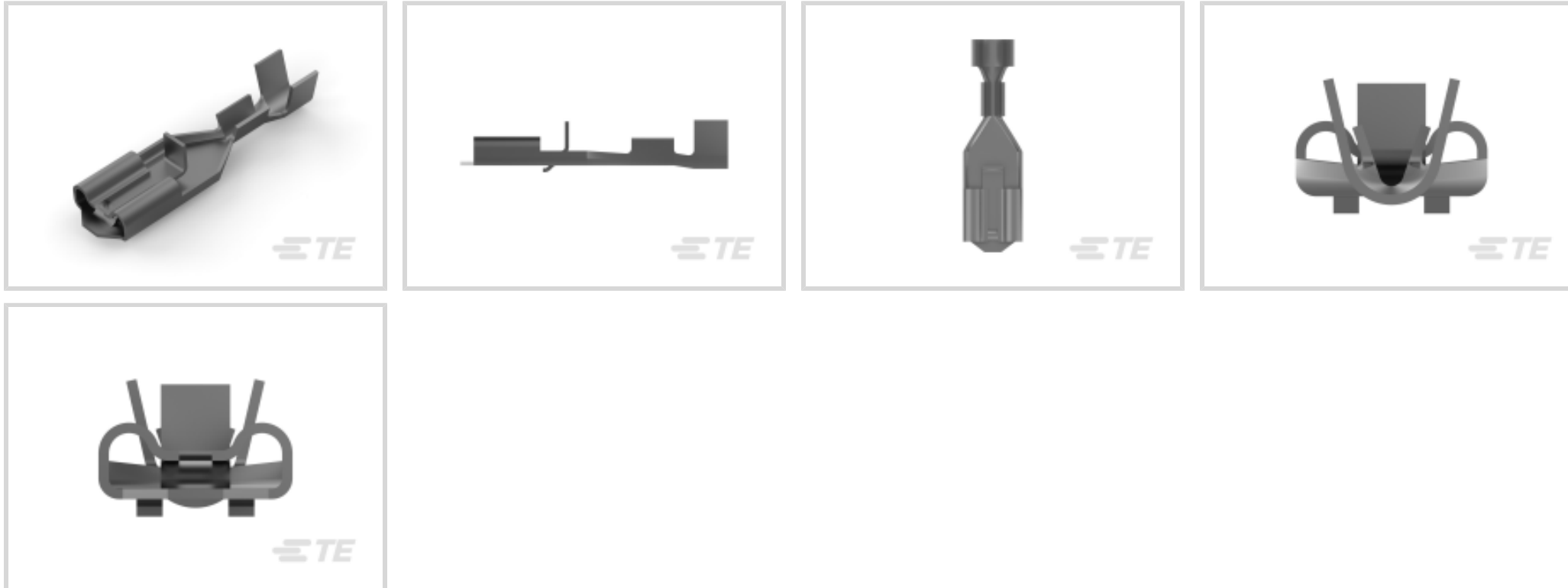

Quick Disconnect Terminal Type: **Receptacle**

Wire Size: .2 – .51 mm²

Mating Tab Width: 4.75 mm [.187 in]

Mating Tab Thickness: .51 mm [.02 in]

Features

Product Type Features

Insertion Force	Low
-----------------	-----

Configuration Features

Connection Capacity	Single
Compatible With Wire & Cable Type	Discrete Wire

Contact Features

Quick Disconnect Terminal Type	Receptacle
Mating Tab Width	4.75 mm [.187 in]
Mating Tab Thickness	.51 mm [.02 in]
Terminal Orientation	Straight
Contact Base Material	Brass
Terminal Plating Material	Pre-Tin
Crimp Type	F-Crimp
Barrel Type	Open

Termination Features

--	--



Product Terminates To	Wire & Cable
-----------------------	--------------

Mechanical Attachment

Wire Insulation Support	With
Mating Retention Type	Dimple

Dimensions

Terminal Material Thickness	.3 mm[.012 in]
Product Length	21.6 mm[.85 in]
Compatible Insulation Diameter Range	1.5 – 2.7 mm[.059 – .106 in]
Wire Size	.2 – .51 mm ²

Usage Conditions

Insulation Option	Uninsulated
Operating Temperature Range	-40 – 110 °C[-40 – 230 °F]

Industry Standards

Agency/Standard	UL
-----------------	----

Packaging Features

Packaging Quantity	1000
Packaging Method	Loose Piece/Carton

Product Compliance

[For compliance documentation, visit the product page on TE.com>](#)

EU RoHS Directive 2011/65/EU	Compliant
EU ELV Directive 2000/53/EC	Compliant
China RoHS 2 Directive MIIT Order No 32, 2016	No Restricted Materials Above Threshold
EU REACH Regulation (EC) No. 1907/2006	Current ECHA Candidate List: JUNE 2023 (235) Candidate List Declared Against: JUNE 2023 (235) Does not contain REACH SVHC
Halogen Content	Low Halogen - Br, Cl, F, I < 900 ppm per homogenous material. Also BFR/CFR/PVC Free
Solder Process Capability	Not applicable for solder process capability

Product Compliance Disclaimer

This information is provided based on reasonable inquiry of our suppliers and represents our current actual knowledge based on the information they provided. This information is subject to change. The part numbers that TE has identified as EU RoHS compliant have a maximum concentration of 0.1% by weight in homogenous materials for lead, hexavalent chromium, mercury, PBB, PBDE, DBP, BBP, DEHP, DIBP, and 0.01% for cadmium, or qualify for an exemption to these limits as defined in the Annexes of Directive 2011/65/EU (RoHS2). Finished electrical and electronic equipment products will be CE marked as required by Directive 2011/65/EU. Components may not be CE marked. Additionally, the part numbers that TE has identified as EU ELV compliant have a maximum concentration of 0.1% by weight in homogenous materials for lead, hexavalent chromium, and mercury, and 0.01% for cadmium, or qualify for an exemption to these limits as defined in the Annexes of Directive 2000/53/EC (ELV). Regarding the REACH Regulation, the information TE provides on SVHC in articles for this part number is based on the latest European Chemicals Agency (ECHA) 'Guidance on requirements for substances in articles' posted at this URL: <https://echa.europa.eu/guidance-documents/guidance-on-reach>

Compatible Parts



TE Part # 724659-1
EXT TOOL FOR POSITIVE .187



TE Part # 172075-1
POSITIVE LOCK 187 HOUSING RECEPTACLE



TE Part # 1-172075-1
3 POS PL 187(4.8 MM) HOUSING NATURAL



TE Part # 173974-6
PL MKII 187 REC HSG 1P NYLON BLUE



TE Part # 174513-1
PL 187 HOUSING RECEPTACLE



TE Part # 1-174587-1
PL MK2 2P 187 HOUSING RECEPTACLE NAT



TE Part # 176498-1
POSITIVE LOCK 187 (4.8 MM) HOUSING



TE Part # 1-174712-1
187 HSG. PL MKII REC. 6.65mm 2P NAT



TE Part # 174712-1
PL 187 (4.8 MM) HOUSING RECEPTACLE



TE Part # 172074-1
187 HSG. PLMKII REC. NAT



TE Part # 173974-1
187 HSG. PL MKII REC. NAT



TE Part # 176498-4
POSITIVE LOCK 187 (4.8 MM) HOUSING



TE Part # 2063760-1
CCII 187 POSITIVE LOCK REC 24-20 ASSY



TE Part # 179183-6
POSITIVE LOCK 187 (4.8 MM) HOUSING



TE Part # 175578-1
PL 187 HOUSING RECEPTACLE

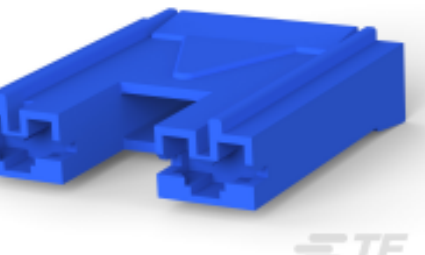

TE Part # 176498-6
PL MKII 187 REC HSG 2P NYLON BLUE



Also in the Series | **Mark II**

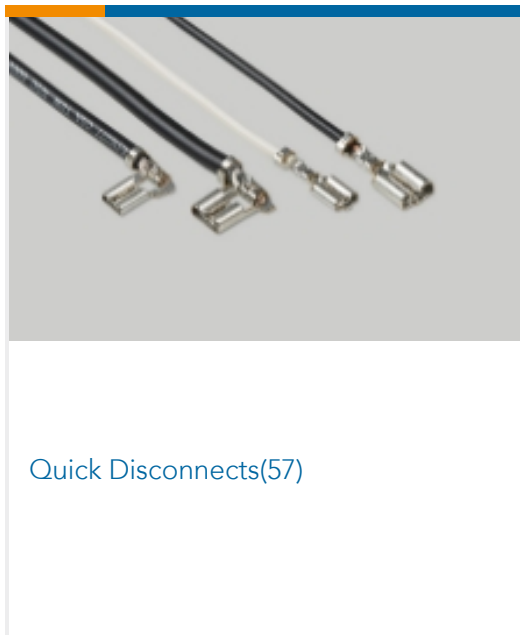
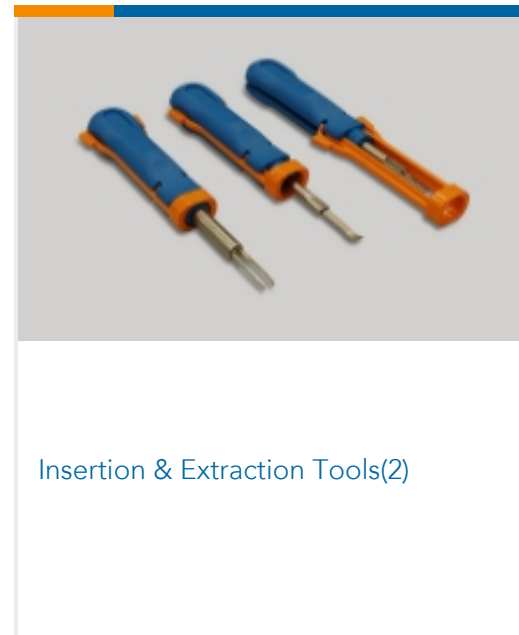
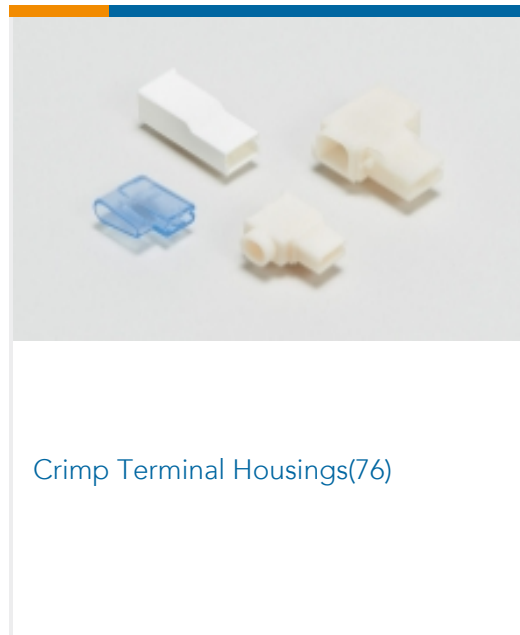
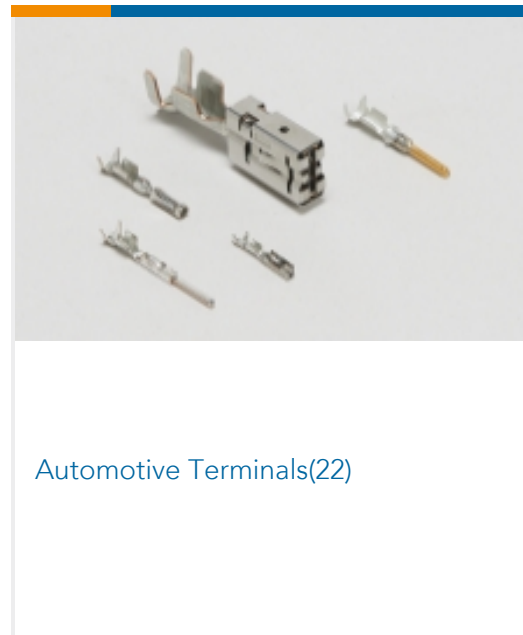
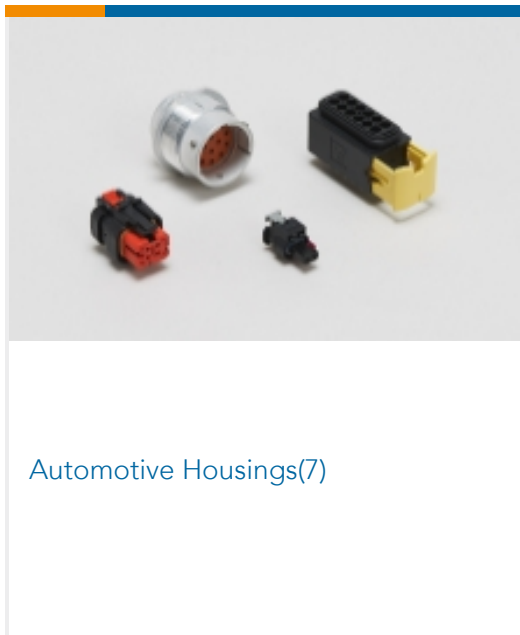

Also in the Series | **Positive Lock 187**

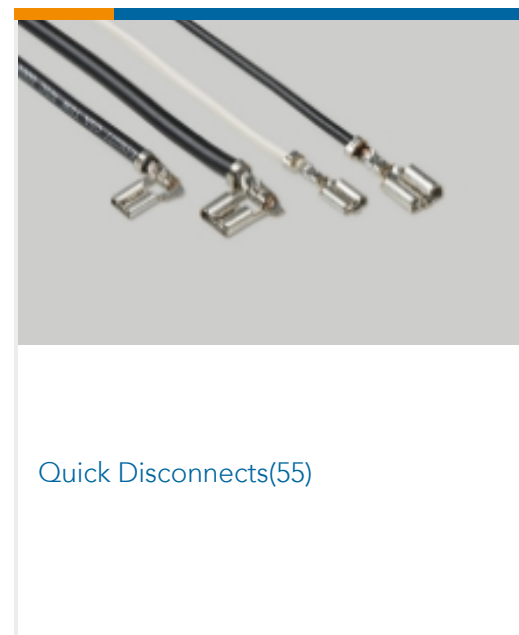
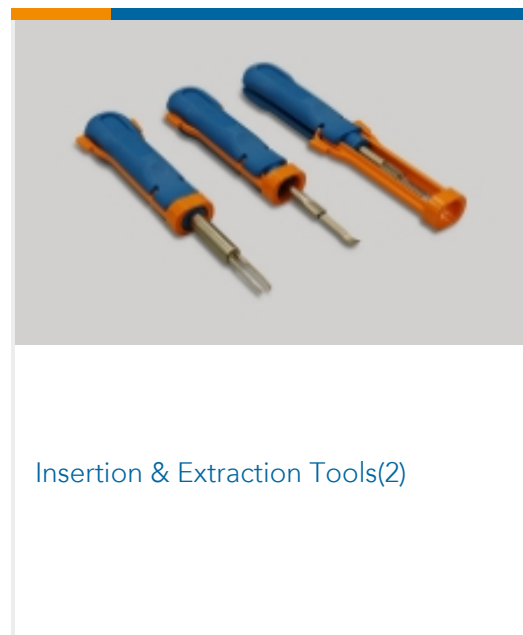
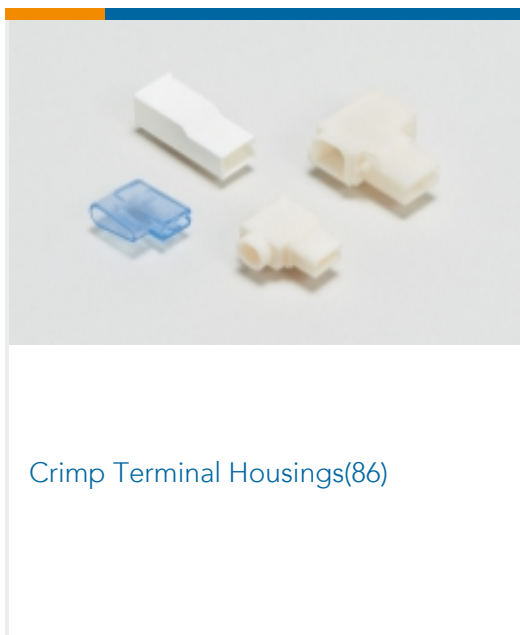

Customers Also Bought

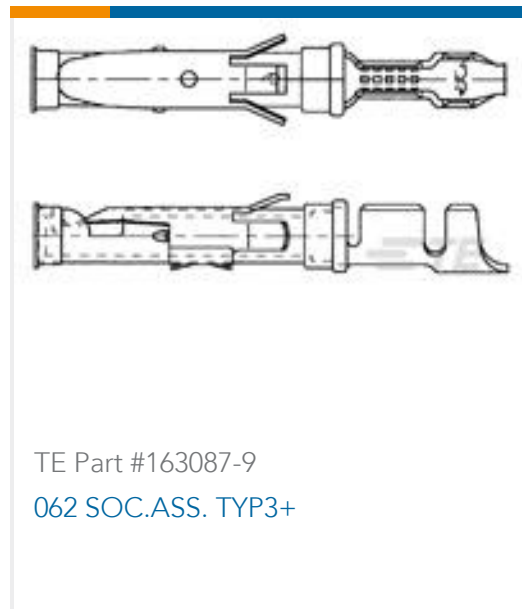

Documents

Product Drawings

[PL MKII 187 REC 24-20AWG PTBR LP](#)

Japanese

CAD Files

[3D PDF](#)

3D

Customer View Model

[ENG_CVM_CVM_170330-1_C.2d_dxf.zip](#)

English

Customer View Model

[ENG_CVM_CVM_170330-1_C.3d_igs.zip](#)

English

Customer View Model

[ENG_CVM_CVM_170330-1_C.3d_stp.zip](#)

English

By downloading the CAD file I accept and agree to the [Terms and Conditions](#) of use.

Datasheets & Catalog Pages



1654742_HOUSEHOLD_APPLIANCES_RAST5

English

Product Specifications

Application Specification

English

Product Environmental Compliance

Product Compliance

English

Product Compliance

English