

Quad 2-Input NAND Gate with Schmitt-Trigger Inputs High-Performance Silicon-Gate CMOS

The 74HC132 is identical in pinout to the LS132. The device inputs are compatible with standard CMOS outputs; with pull-up resistors, they are compatible with LSTTL outputs.

The HC132 can be used to enhance noise immunity or to square up slowly changing waveforms.

Features

- Output Drive Capability: 10 LSTTL Loads
- Outputs Directly Interface to CMOS, NMOS, and TTL
- Operating Voltage Range: 2.0 to 6.0 V
- Low Input Current: 1.0 μ A
- High Noise Immunity Characteristic of CMOS Devices
- In Compliance with the Requirements as Defined by JEDEC Standard No. 7A
- ESD Performance: HBM > 2000 V; Machine Model > 200 V
- Chip Complexity: 72 FETs or 18 Equivalent Gates
- These are Pb-Free Devices

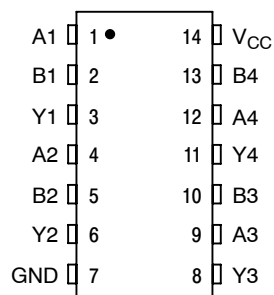
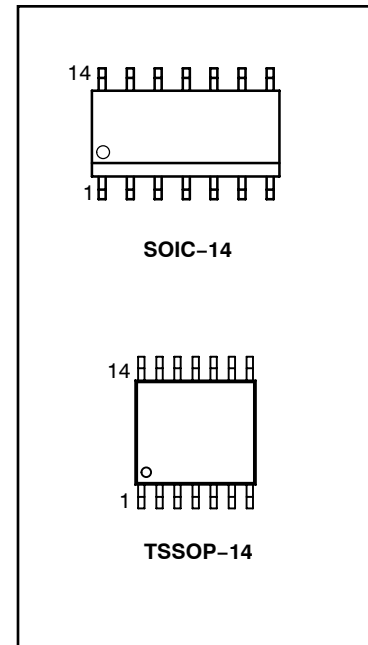

Figure 1. Pin Assignment

FUNCTION TABLE

Inputs		Output
A	B	Y
L	L	H
L	H	H
H	L	H
H	H	L

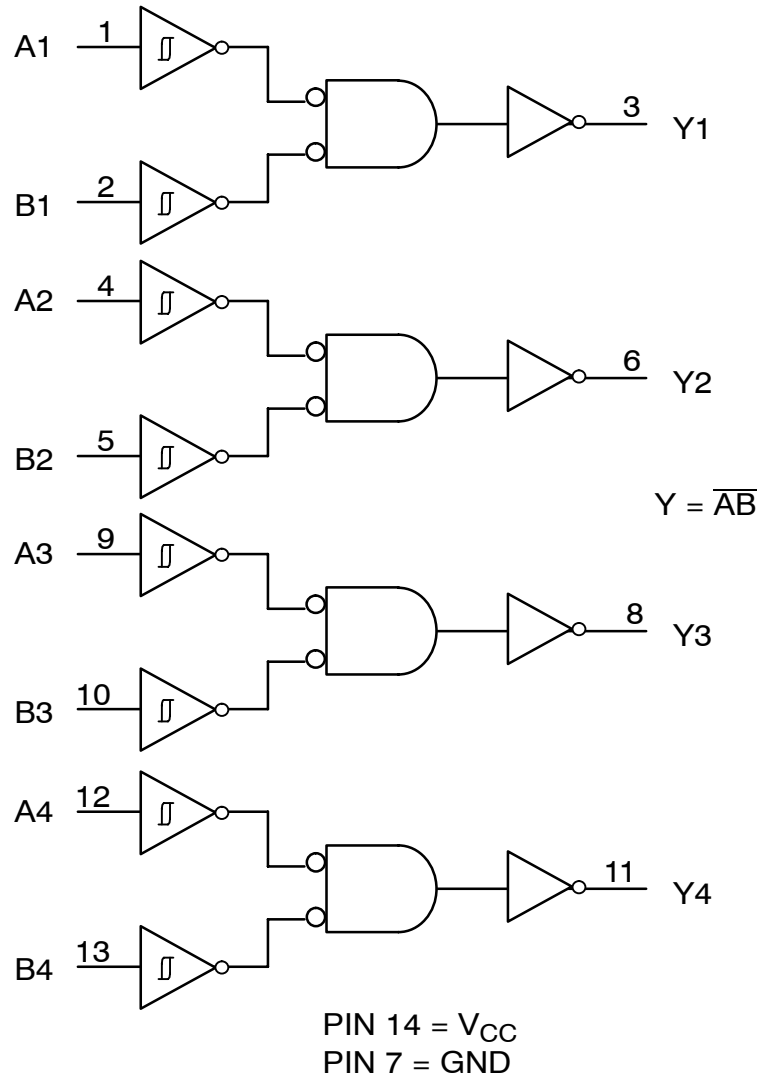

Figure 2. Logic Diagram

MAXIMUM RATINGS

Symbol	Parameter	Value	Unit
V_{CC}	Positive DC Supply Voltage	- 0.5 to + 7.0	V
V_{IN}	Digital Input Voltage	- 0.5 to + 7.0	V
V_{OUT}	DC Output Voltage Output in 3-State High or Low State	- 0.5 to + 7.0 - 0.5 to V_{CC} + 0.5	V
I_{IK}	Input Diode Current	- 20	mA
I_{OK}	Output Diode Current	± 20	mA
I_{OUT}	DC Output Current, per Pin	± 25	mA
I_{CC}	DC Supply Current, V_{CC} and GND Pins	± 75	mA
I_{GND}	DC Ground Current per Ground Pin	± 75	mA
T_{STG}	Storage Temperature Range	- 65 to + 150	°C
T_L	Lead Temperature, 1 mm from Case for 10 Seconds	260	°C
T_J	Junction Temperature Under Bias	+ 150	°C
θ_{JA}	Thermal Resistance 14-SOIC 14-TSSOP	125 170	°C/W
P_D	Power Dissipation in Still Air at 85°C SOIC TSSOP	500 450	mW
MSL	Moisture Sensitivity	Level 1	
F_R	Flammability Rating Oxygen Index: 30% - 35%	UL 94 V-0 @ 0.125 in	
V_{ESD}	ESD Withstand Voltage Human Body Model (Note 1) Machine Model (Note 2)	> 2000 > 200	V
$I_{Latchup}$	Latchup Performance Above V_{CC} and Below GND at 85°C (Note 3)	± 300	mA

Stresses exceeding Maximum Ratings may damage the device. Maximum Ratings are stress ratings only. Functional operation above the Recommended Operating Conditions is not implied. Extended exposure to stresses above the Recommended Operating Conditions may affect device reliability.

1. Tested to EIA/JESD22-A114-A.
2. Tested to EIA/JESD22-A115-A.
3. Tested to EIA/JESD78.

RECOMMENDED OPERATING CONDITIONS

Symbol	Parameter	Min	Max	Unit
V_{CC}	DC Supply Voltage (Referenced to GND)	2.0	6.0	V
V_{IN}, V_{OUT}	DC Input Voltage, Output Voltage (Referenced to GND)	0	V_{CC}	V
T_A	Operating Temperature, All Package Types	- 55	+ 125	°C
t_r, t_f	Input Rise and Fall Time (Figure 3)	-	No Limit (Note 5)	ns

5. When $V_{IN} \sim 0.5 V_{CC}$, $I_{CC} \gg$ quiescent current.
6. Unused inputs may not be left open. All inputs must be tied to a high-logic voltage level or a low-logic input voltage level.

DC ELECTRICAL CHARACTERISTICS (Voltages Referenced to GND)

Symbol	Parameter	Test Conditions	V _{CC} (V)	Guaranteed Limit			Unit
				-55°C to 25°C	≤ 85°C	≤ 125°C	
V _{T+} max	Maximum Positive-Going Input Threshold Voltage (Figure 5)	V _{OUT} = 0.1 V I _{OUT} ≤ 20 μA	2.0	1.5	1.5	1.5	V
			4.5	3.15	3.15	3.15	
			6.0	4.2	4.2	4.2	
V _{T+} min	Minimum Positive-Going Input Threshold Voltage (Figure 5)	V _{OUT} = 0.1 V I _{OUT} ≤ 20 μA	2.0	1.0	0.95	0.95	V
			4.5	2.3	2.25	2.25	
			6.0	3.0	2.95	2.95	
V _{T-} max	Maximum Negative-Going Input Threshold Voltage (Figure 5)	V _{OUT} = V _{CC} - 0.1 V I _{OUT} ≤ 20 μA	2.0	0.9	0.95	0.95	V
			4.5	2.0	2.05	2.05	
			6.0	2.6	2.65	2.65	
V _{T-} min	Minimum Negative-Going Input Threshold Voltage (Figure 5)	V _{OUT} = V _{CC} - 0.1 V I _{OUT} ≤ 20 μA	2.0	0.3	0.3	0.3	V
			4.5	0.9	0.9	0.9	
			6.0	1.2	1.2	1.2	
V _H max (Note 7)	Maximum Hysteresis Voltage (Figure 5)	V _{OUT} = 0.1 V or V _{CC} - 0.1 V I _{OUT} ≤ 20 μA	2.0	1.2	1.2	1.2	V
			4.5	2.25	2.25	2.25	
			6.0	3.0	3.0	3.0	
V _H min (Note 7)	Minimum Hysteresis Voltage (Figure 5)	V _{OUT} = 0.1 V or V _{CC} - 0.1 V I _{OUT} ≤ 20 μA	2.0	0.2	0.2	0.2	V
			4.5	0.4	0.4	0.4	
			6.0	0.5	0.5	0.5	
V _{OH}	Minimum High-Level Output Voltage	V _{IN} ≤ V _{T-} min or V _{T+} max I _{OUT} ≤ 20 μA	2.0	1.9	1.9	1.9	V
			4.5	4.4	4.4	4.4	
		V _{IN} ≤ -V _{T-} min or V _{T+} max I _{OUT} ≤ 4.0 mA I _{OUT} ≤ 5.2 mA	4.5	3.98	3.84	3.7	
			6.0	5.48	5.34	5.2	
V _{OL}	Maximum Low-Level Output Voltage	V _{IN} ≥ V _{T+} max I _{OUT} ≤ 20 μA	2.0	0.1	0.1	0.1	V
			4.5	0.1	0.1	0.1	
		V _{IN} ≥ V _{T+} max I _{OUT} ≤ 4.0 mA I _{OUT} ≤ 5.2 mA	4.5	0.26	0.33	0.4	
			6.0	0.26	0.33	0.4	
I _{IN}	Maximum Input Leakage Current	V _{IN} = V _{CC} or GND	6.0	± 0.1	± 1.0	± 1.0	μA
I _{CC}	Maximum Quiescent Supply Current (per Package)	V _{IN} = V _{CC} or GND I _{OUT} = 0 μA	6.0	2.0	20	40	μA

7. V_Hmin > (V_{T+}min) - (V_{T-}max); V_Hmax = (V_{T+}max) + (V_{T-}min).

8. Information on typical parametric values can be found in the ON Semiconductor High-Speed CMOS Data Book (DL129/D).

AC ELECTRICAL CHARACTERISTICS ($C_L = 50 \text{ pF}$, Input $t_r = t_f = 6.0 \text{ ns}$)

Symbol	Parameter	V_{CC} (V)	Guaranteed Limit			Unit
			-55°C to 25°C	$\leq 85^\circ\text{C}$	$\leq 125^\circ\text{C}$	
t_{PLH} , t_{PHL}	Maximum Propagation Delay, Input A or B to Output Y (Figures 3 and 4)	2.0 4.5 6.0	125 25 21	155 31 26	190 38 32	ns
t_{TLH} , t_{THL}	Maximum Output Transition Time, Any Output (Figures 3 and 4)	2.0 4.5 6.0	75 15 13	95 19 16	110 22 19	ns
C_{in}	Maximum Input Capacitance	—	10	10	10	pF

9. For propagation delays with loads other than 50 pF, and information on typical parametric values, see the ON Semiconductor High-Speed CMOS Data Book (DL129/D).

Symbol	Parameter	Typical @ 25°C , $V_{CC} = 5.0 \text{ V}$		Unit
		C_{PD}	Power Dissipation Capacitance (per Gate) (Note 10)	

10. Used to determine the no-load dynamic power consumption: $P_D = C_{PD} V_{CC}^2 f + I_{CC} V_{CC}$. For load considerations, see the ON Semiconductor High-Speed CMOS Data Book (DL129/D).

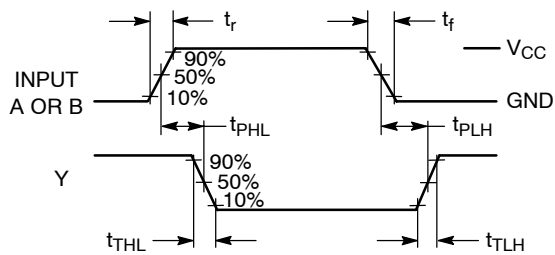
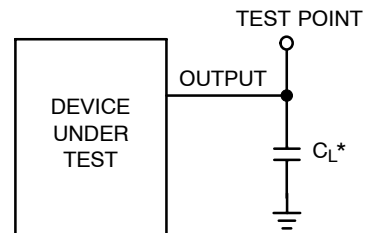

Figure 3. Switching Waveforms



*Includes all probe and jig capacitance

Figure 4. Test Circuit

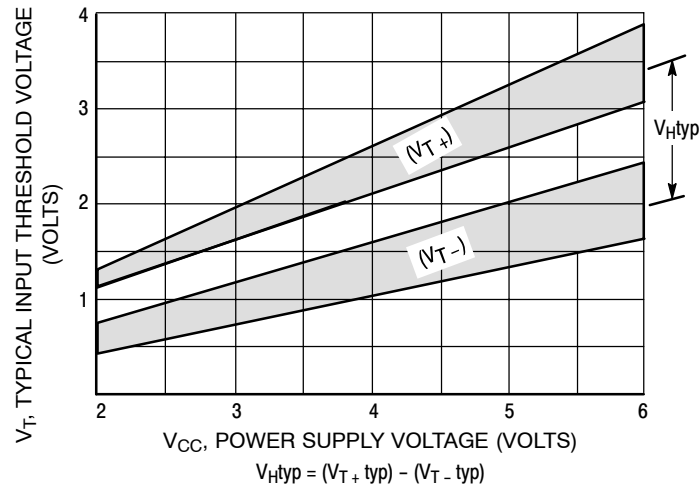

Figure 5. Typical Input Threshold, V_{T+} , V_{T-} Versus Power Supply Voltage

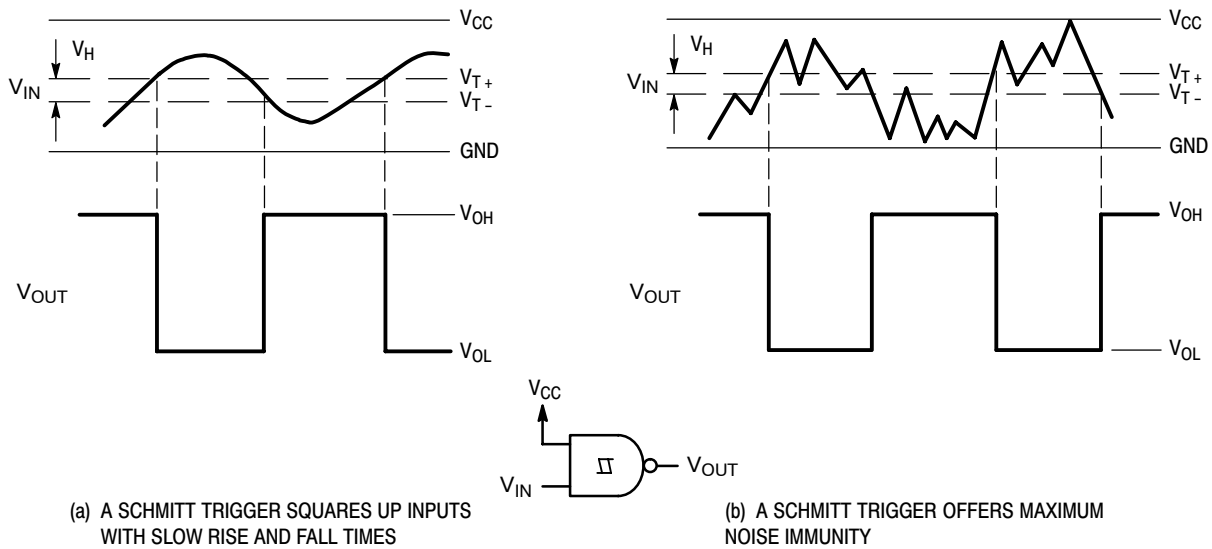

Figure 6. Typical Schmitt-Trigger Applications

Important statement:

Huaguan Semiconductor Co,Ltd. reserves the right to change the products and services provided without notice. Customers should obtain the latest relevant information before ordering, and verify the timeliness and accuracy of this information.

Customers are responsible for complying with safety standards and taking safety measures when using our products for system design and machine manufacturing to avoid potential risks that may result in personal injury or property damage.

Our products are not licensed for applications in life support, military, aerospace, etc., so we do not bear the consequences of the application of these products in these fields.

Our documentation is only permitted to be copied without any tampering with the content, so we do not accept any responsibility or liability for the altered documents.