

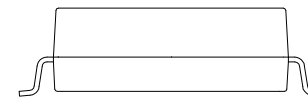

NOTES:

1. ROHS COMPLIANT
2. STORAGE TEMPERATURE: -50°C TO +125°C
3. COMPLIANCE TO J-STD:
 - A. J-STD-002: SOLDERABILITY AT 245°C REFLOW PROFILE
 - B. J-STD-020: LEVEL 1, NO MOISTURE SENSITIVE
 - C. J-STD-075: R7, 245°C MAXIMUM THROUGH REFLOW SOLDER
4. TO ORDER TAPE & REEL PACKAGING ADD A "T" SUFFIX TO THE PART NUMBER(i.e HXXXXXXXXNL BECOMES HXXXXXXXXNLT).
5. MEETS AEC-Q200 REQUIREMENTS
6. PACKING SPECIFICATION:
 REEL SIZE: 330mm
 TAPE WIDTH: 24mm
 TAPE PITCH: 24mm

 COMPONENTS PER REEL: 350 pcs

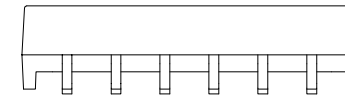
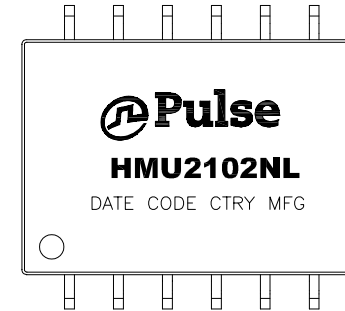

FINAL OUTLINE

© Copyright, 2017. Pulse Electronics Corp. All rights reserved. Pulse confidential & proprietary. (09/01/17)

PRODUCT DESCRIPTION	TLA DRAWING	PS DRAWING	SHEET	PART NO.	DATASHEET REV.
XFMR/CMC,DUAL,4.3kV,1:1,SMT,TU	HMU2102NL-13	PS-0023.002-D	1 OF 5	HMU2102NL	F



ELECTRICAL CHARACTERISTICS AT +25°C UNLESS OTHER SPECIFIED
(FOR REFERENCE ONLY. USED FOR CUSTOMER INFORMATION.)

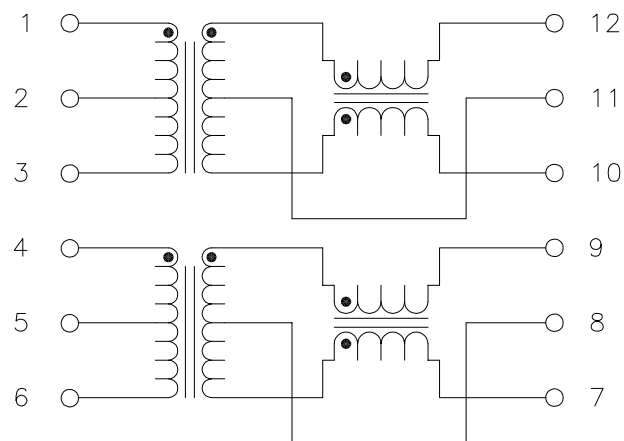

SCHEMATIC

PARAMETER	SPECIFICATIONS	
QUALIFICATION	PER AEC-Q200	
OPERATING TEMPERATURE	-40°C TO +125°C	
TURNS RATIO	1.00 ± 2%	
POLARITY	PER SCHEMATIC	
DC RESISTANCE	TRANSFORMER SIDE	CM CHOKE SIDE
	0.45 OHMS MAX	0.85 OHMS MAX
▽ INDUCTANCE (OCL) AT 100 kHz, 100 mV (-40°C TO +125°C)	150 uH MIN, 370 uH MAX	
▽ INSERTION LOSS	0.30 dB MAX @ 4 MHz	
RETURN LOSS (Z OUT = 100 OHM ±15%)	20 dB MIN @ 4 MHz	
CROSSTALK, ADJACENT CHANNELS	-50 dB MIN @ 4 MHz	
COMMON MODE REJECTION RATIO	1 - 10 MHz	10-1000 MHz
	-35 dB MIN	-20 dB MIN
▽ INPUT - OUTPUT ISOLATION	4300 VDC FOR 60 SECONDS	
WORKING VOLTAGE	1000 VDC FOR 15 YEARS	

NOTE: "▽" IS SPECIAL CHARACTERISTIC.

© Copyright, 2017. Pulse Electronics Corp. All rights reserved. Pulse confidential & proprietary. (09/01/17)

PRODUCT DESCRIPTION	TLA DRAWING	PS DRAWING	SHEET	PART NO.	DATASHEET REV.
XFMR/CMC,DUAL,4.3kV,1:1,SMT,TU	HMU2102NL-13	PS-0023.002-D	2 OF 5	HMU2102NL	F

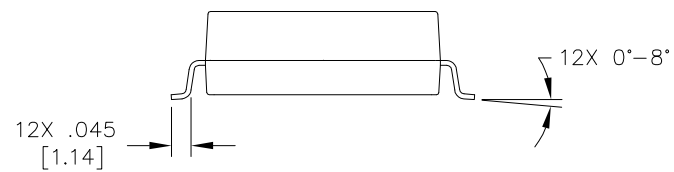
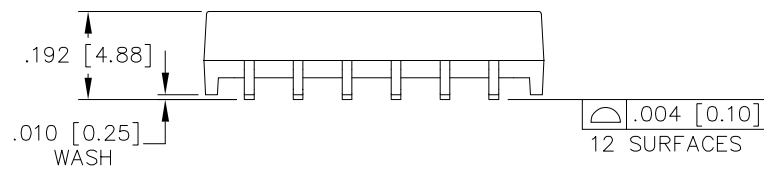
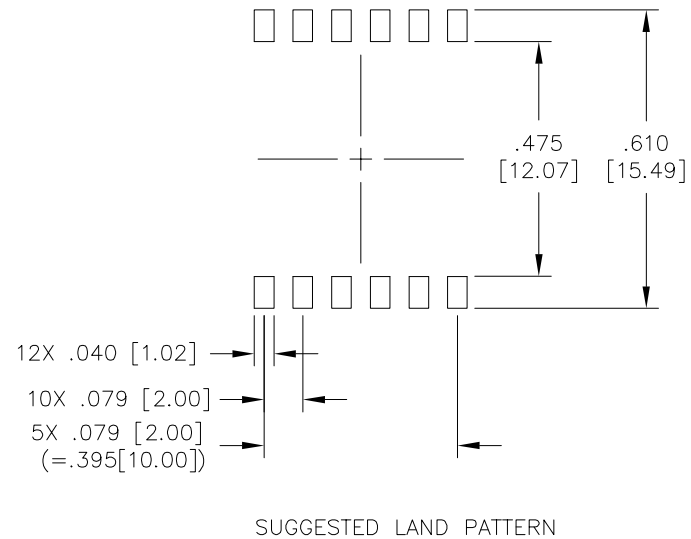
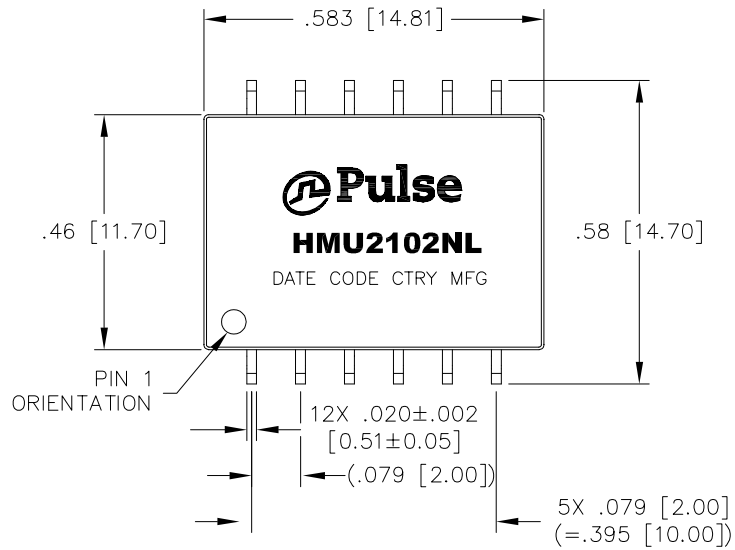

DIMENSIONS ARE IN INCHES [MILLIMETERS] WITH THE FOLLOWING TOLERANCES: [MILLIMETERS] ARE FOR REFERENCE ONLY.
.XX = ±.01 [±0.25]
.XXX = ±.005 [±0.13]

© Copyright, 2017. Pulse Electronics Corp. All rights reserved. Pulse confidential & proprietary. (09/01/17)

PRODUCT DESCRIPTION	TLA DRAWING	PS DRAWING	SHEET	PART NO.	DATASHEET REV.
XFMR/CMC,DUAL,4.3kV,1:1,SMT,TU	HMU2102NL-13	PS-0023.002-D	3 OF 5	HMU2102NL	F



REVISION HISTORY:

REV	DESCRIPTION
A	NEW DS
B	CHANGDE OPERATING TEMPERATURE FROM -40°C TO $+125^{\circ}\text{C}$ TO -40°C TO $+105^{\circ}\text{C}$
C	CHANGDE OPERATING TEMPERATURE FROM -40°C TO $+105^{\circ}\text{C}$ TO -40°C TO $+125^{\circ}\text{C}$ CHANGE OCL FROM 175 μH MIN, 350 μH MAX TO 150 μH MIN, 370 μH MAX
D	CHANGE QUALIFICATION FROM PER AEC-Q200 TO AEC-Q200 (PENDING)
E	CHANGE QUALIFICATION FROM AEC-Q200 (PENDING) TO PER AEC-Q200
F	ADD SC WITH "▽" AND PACKING INFORMATION

© Copyright, 2017. Pulse Electronics Corp. All rights reserved. Pulse confidential & proprietary. (09/01/17)

PRODUCT DESCRIPTION	TLA DRAWING	PS DRAWING	SHEET	PART NO.	DATASHEET REV.
XFMR/CMC,DUAL,4.3kV,1:1,SMT,TU	HMU2102NL-13	PS-0023.002-D	5 OF 5	HMU2102NL	F

Mouser Electronics

Authorized Distributor

Click to View Pricing, Inventory, Delivery & Lifecycle Information:

Pulse:

[HMU2102NL](#)