

Kingtronics®

KBPC25005 THRU KBPC2510

SINGLE-PHASE GLASS PASSIVATED BRIDGE RECTIFIERS

REVERSE VOLTAGE 50 to 1000 Volts FORWARD CURRENT 25.0 Ampere

FEATURES

- High forward surge current capability.
- Low thermal resistance.
- High isolation voltage from case to lugs.
- High temperature soldering guaranteed:
260°C/10 second, at 5 lbs. (2.3kg) tension.

MECHANICAL DATA

- Case: Matel case.
- Terminal: Plated 0.25" (6.35mm) lug.
- Polarity: Polarity symbols marked on case.
- Mounting: Thru hole for #10 screw, 20 in,- lbs. Torque Max.
- Weight:1.02 ounce, 29gram.

MAXIMUM RATINGS AND ELECTRICAL CHARACTERISTICS

**Ratings at 25°C ambient temperature unless otherwise specified ,
Single phase, half wave, 60Hz, resistive or inductive load.
For capacitive load derate current by 20%**

KBPC

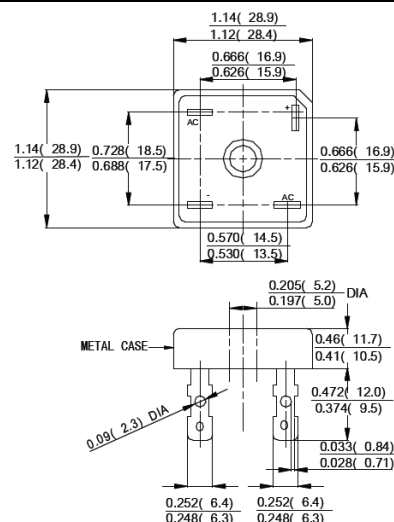

Dimensions in inches and (millimeters)

PARAMETER	SYMBOL	KBPC 25005	KBPC 2501	KBPC 2502	KBPC 2504	KBPC 2506	KBPC 2508	KBPC 2510	UNIT
Maximum Repetitive Peak Reverse Voltage	V_{RRM}	50	100	200	400	600	800	1000	Volts
Maximum RMS Voltage	V_{RMS}	35	70	140	280	420	560	700	Volts
Maximum DC Blocking Voltage	V_{DC}	50	100	200	400	600	800	1000	Volts
Maximum Average Forward Rectified Output Current at $T_C=50^\circ C$ (Note1,2)	$I_{(AV)}$	25							Amps
Peak Forward Surge Current 8.3ms single half sine-wave superimposed on rated load (JEDEC Method)	I_{FSM}	300							Amps
Rating for Fusing($t<8.3ms$)	I_2T	373							A^2s
Maximum Instantaneous Forward Voltage at 12.5A	V_F	1.1							Volts
Maximum Reverse Current at Rated DC Blocking Voltage	$T_A=25^\circ C$	5.0							μA mps
	$T_A=125^\circ C$	0.5							mAmps
Isolation Voltage from case to lugs	V_{ISO}	2500							V_{AC}
Typical Thermal Resistance (Note 1,2)	$R_{\theta JL}$	2.0							$^\circ C/W$
Operating Temperature Range	T_J	-65 to +150							$^\circ C$
Storage Temperature Range	T_{stg}	-65 to +150							$^\circ C$

- Unit mounted on 9"x3.5"x4.6" thick (23x9x11.8mm) Al. finned plate.
- Bolt down on heat-sink with silicone thermal compound between bridge and mounting surface for maximum heat transfer efficiency with #10 screw.

Kingtronics® International Company

Kingtronics®

KBPC25005 THRU KBPC2510

RATINGS AND CHARACTERISTIC CURVES

FIG.1-DERATING CURVE FOR
OUTPUT RECTIFIED CURRENT

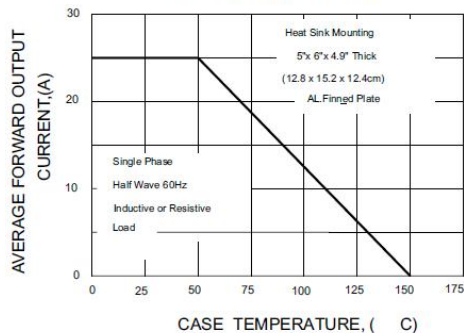

FIG.2-MAXIMUM NON-REPETITIVE PEAK
FORWARD SURGE CURRENT PER ELEMENT

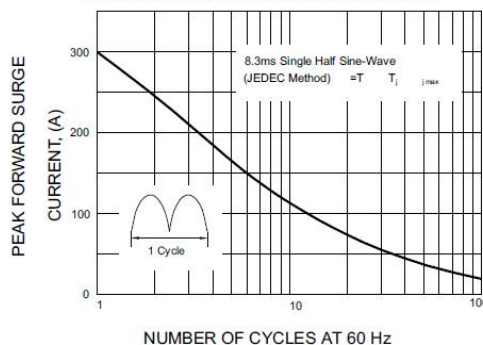

FIG.3-TYPICAL FORWARD CHARACTERISTICS
PER BRIDGE ELEMENT

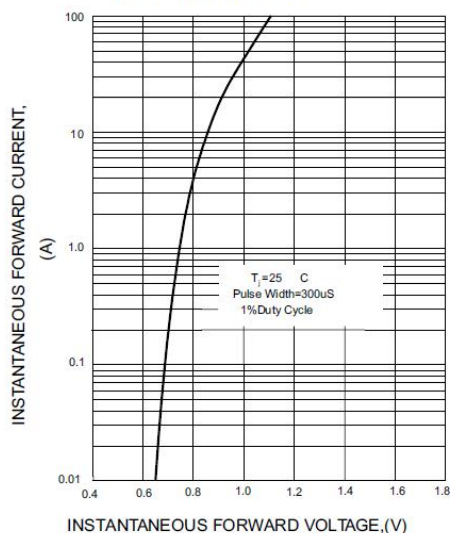

FIG.4-TYPICAL REVERSE CHARACTERISTICS
PER BRIDGE ELEMENT

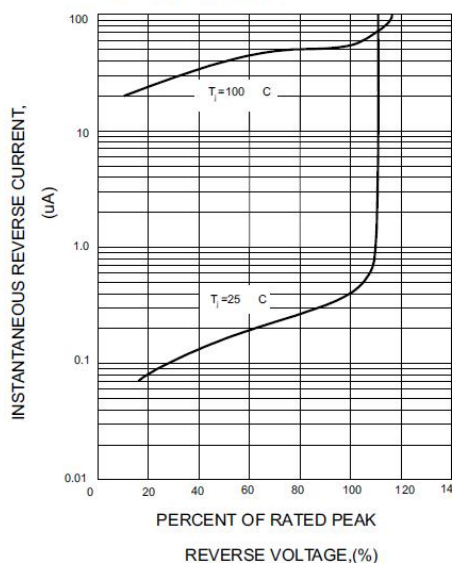

FIG.5-TYPICAL JUNCTION CAPACITANCE
PER BRIDGE ELEMENT

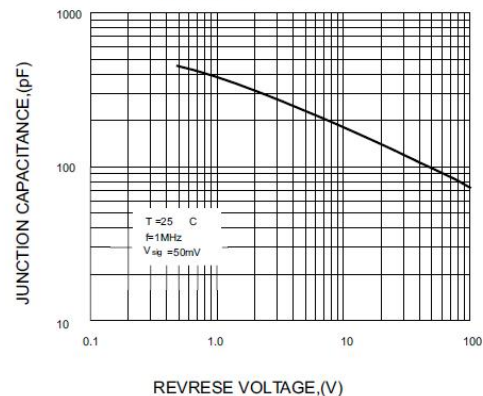
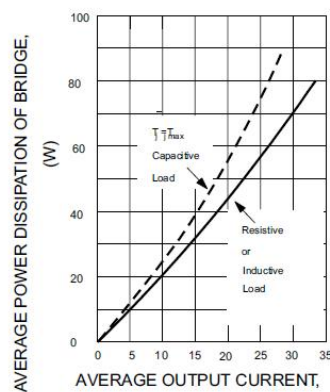

FIG.6-MAXIMUM POWER DISSIPATION



Note: Specifications are subject to change without notice.

Kingtronics® International Company