

SEMIDRIVER™

High Power IGBT Driver

SKHI 10/17 (R)

Features

- Single driver circuit for high power IGBTs
- SKHI 10/17 drives all SEMIKRON IGBTs with V_{CES} up to 1700 V (factory adjustment of V_{CES} -monitoring for 1700V-IGBT)
- CMOS/TTL (HCMOS) compatible input buffers
- Short circuit protection by V_{CE} monitoring
- Soft short circuit turn-off
- Isolation due to transformers (no opto couplers)
- Supply undervoltage monitoring (< 13 V)
- Error memory / output signal (LOW or HIGH logic)
- Internal isolated power supply

Typical Applications

- High frequency SMPS
- Braking choppers
- Asymmetrical bridges
- High power UPS

1) This current value is a function of the output load conditio

2) This value does not consider t_{on} of IGBT and t_{MIN} adjusted by R_{CE} and C_{CE}

3) Matched to be used with IGBTs < 100A; for higher currents, see table 2

4) With $R_{CE} = 36 \text{ k}\Omega$, $C_{CE} = 470 \text{ pF}$; see fig. 6

Absolute Maximum Ratings		$T_a = 25^\circ\text{C}$, unless otherwise specified	
Symbol	Conditions	Values	Units
V_S	Supply voltage primary	18	V
V_{iH}	Input signal voltage (HIGH) (for 15 V and 5 V input level)	$V_S + 0,3$	V
I_{out_PEAK}	Output peak current	± 8	A
I_{out_AVmax}	Output average current (max.)	± 100	mA
V_{CE}	Collector emitter voltage sense	1700	V
dv/dt	Rate of rise and fall of voltage (secondary to primary side)	75	kV/ μs
$V_{isol\ IO}$	Isolation test volt. IN-OUT (2 sec. AC)	4000	V
$R_{Gon\ min}$	minimal R_{Gon}	2,7	Ω
$R_{Goff\ min}$	minimal R_{Goff}	2,7	Ω
$Q_{out/pulse}$	charge per pulse	9,6	μC
T_{op}	Operating temperature	- 25 ... + 85	$^\circ\text{C}$
T_{stg}	Storage temperature	- 25 ... + 85	$^\circ\text{C}$

Characteristics		$T_a = 25^\circ\text{C}$, unless otherwise specified			
Symbol	Conditions	min.	typ.	max.	Units
V_S	Supply voltage primary	14,4	15,0	15,6	V
I_S	Supply current (max.)		0,3 ¹⁾		A
I_{SO}	Supply current primary side (no load)		90		mA
V_{iT+}	Input threshold voltage (HIGH) for 15 V input level	12,5			V
	for 5 V input level	2,4			V
V_{iT-}	Input threshold voltage (LOW) for 15 V input level			3,6	V
	for 5 V input level			0,50	V
$V_{G(on)}$	Turn-on output gate voltage		+ 15		V
$V_{G(off)}$	Turn-off output gate voltage		- 8		V
f	Maximum operating frequency		see fig. 15		
$td(on)_{IO}$	Input-output turn-on propagation time		1,4		μs
$td(off)_{IO}$	Input-output turn-off propagation time		1,4		μs
$t_{d(Err)}$	Error input-output propagation time		1,0 ²⁾		μs
V_{CEstat}	Reference voltage for V_{CE} monitoring		6,3 ⁴⁾		V
R_{IN}	Input resistance		10		k Ω
R_{Gon}	Internal gate resistor for ON signal		22 ³⁾		Ω
R_{Goff}	Internal gate resistor for OFF signal		22 ³⁾		Ω
C_{ps}	Primary to secondary capacitance		12		pF

This technical information specifies semiconductor devices but promises no characteristics. No warranty or guarantee expressed or implied is made regarding delivery, performance or suitability.

Block diagram SKHI10

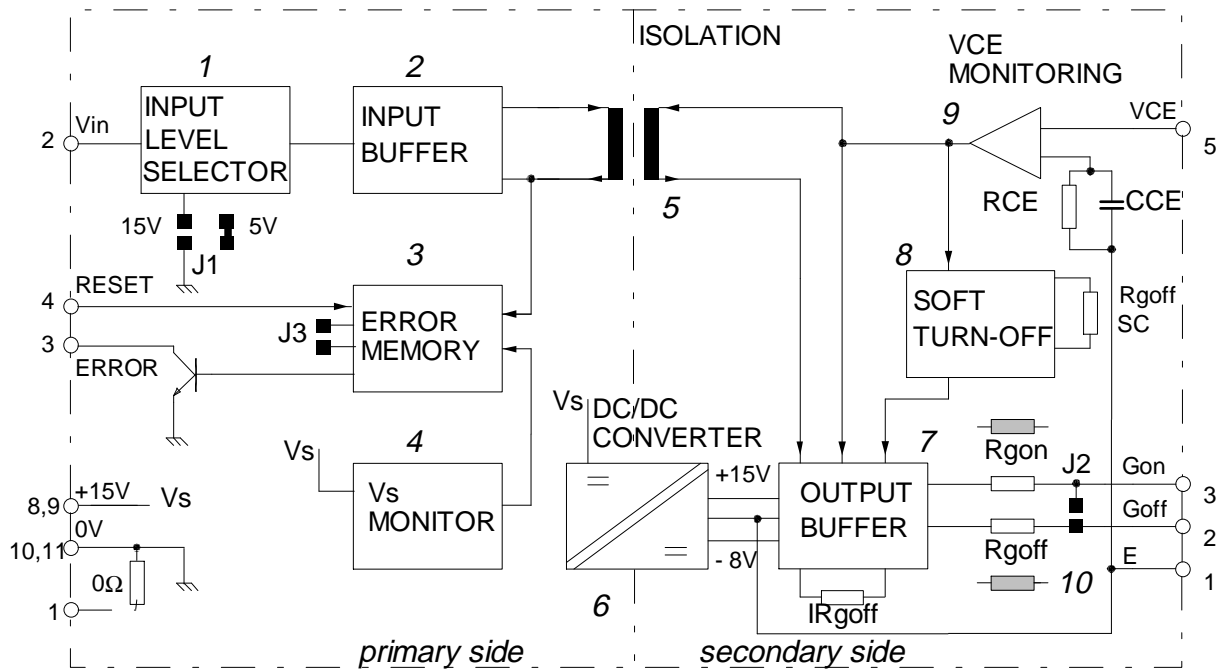
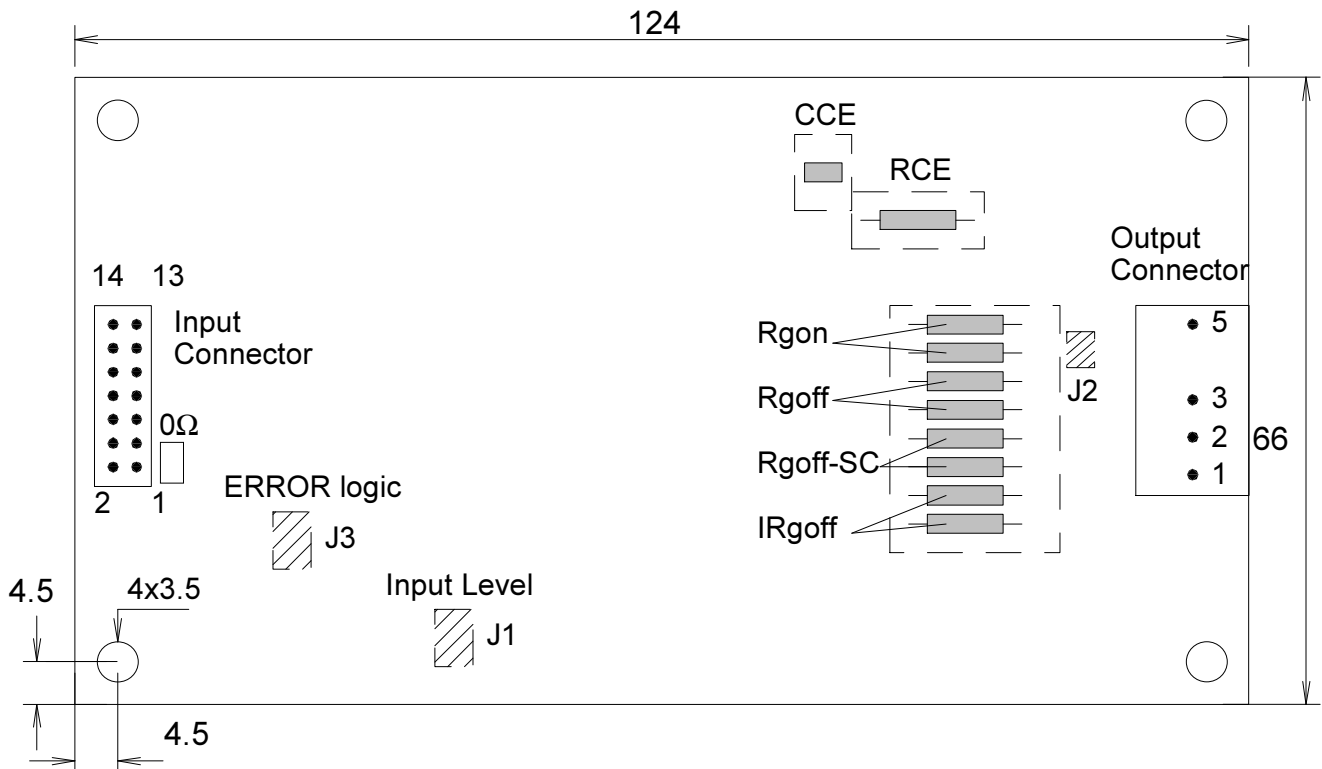

Fig.1 The numbers refer to the description on page 4, section B.



Input connector = 14 pin flat cable according to DIN 41651

Output connector = MOLEX 41791 Series (mates with 41695 crimp terminal housing and crimp terminals 7258)

Fig.2 Dimensions (in mm) and connections of the SKHI 10

SEMIDRIVER™ SKHI 10

SEMIDRIVER™ SKHI 10/17

High Power Single IGBT Driver

General

The intelligent single IGBT driver, SKHI10 respectively SKHI 10/17 is a standard driver for all power IGBTs on the market.

The high power output capability was designed to switch high current modules or several paralleled IGBTs even for high frequency applications. The output buffer has been improved to make it possible to switch up to 400A IGBT modules at frequencies up to 20kHz.

A new function has been added to the short circuit protection circuitry (Soft Turn Off), this automatically increases the IGBT turn off time and hence reduces the DC voltage overvoltage spikes, enabling the use of higher DC-bus voltages. This means an increase in the final output power. An integrated DC/DC converter with high galvanic isolation (4 kV) ensures that the user is protected from the high voltage (secondary side).

The power supplies for the driver may be the same as used in the control board (0/+15V) without the requirement of isolation. All information that is transmitted between input and output uses ferrite transformers, resulting in high dv/dt immunity (75kV/μs).

The driver input stage is connected directly to the control board output and due to different control board operating voltages the SKHI10's input circuit includes a user voltage level selector (+15V or +5V).

In the following only the designation SKHI 10 is used. This is valid for both driver versions. If something is to be explained special to SKHI 10/17 it will be described by marking SKHI 10/17.

A. Features and Configuration of the Driver

A short description is given below. For detailed information, please refer to section B.

- The SKHI10 has an INPUT LEVEL SELECTOR circuit which is adjusted by J1 for two different levels. It is present for CMOS (15V) level, but can be changed by the user to HCMOS (5V) level by solder bridging the pads marked J1 together. For long input cables, we do not recommend the 5V level due to possible disturbances emitted by the power side.
- The ERROR MEMORY blocks the transmission of all turn-on signals to the IGBT if either a short circuit or malfunction of V_S is detected, and sends a signal to the external control board through an open collector transistor.
- With a FERRITE TRANSFORMER the information between primary and secondary may flow in both directions and high levels of dv/dt and isolation are obtained.
- A high frequency DC/DC CONVERTER avoids the requirement of external isolated power supplies to obtain the necessary gate voltage. An isolated ferrite transformer in half-bridge configuration supplies the necessary power to the gate of the IGBT. With this

feature, we can use the same power supply used in the external control circuit, even if we are using more than one SKHI10, e.g. in H-bridge configurations.

- Short circuit protection is provided by measuring the collector-emitter voltage with a V_{CE} MONITORING circuit. An additional circuit detects the short circuit after a delay (determined by R_{CE}, C_{CE}) and decreases the turn off speed (adjusted by $R_{goff-SC}$) of the IGBT. SOFT TURN-OFF under fault conditions is necessary as it reduces the voltage overshoot and allows for a faster turn off during normal operation.
- The OUTPUT BUFFER is responsible for providing the correct current to the gate of the IGBT. If these signals do not have sufficient power, the IGBT will not switch properly, and additional losses or even the destruction of the IGBT may occur. According to the application (switching frequency and gate charge of the IGBT) the equivalent value of R_{gon} and the R_{goff} must be matched to the optimum value. This can be done by putting additional parallel resistors R_{gon}, R_{goff} with those already on the board. If only one IGBT is to be used, (instead of parallel connection) only one cable could be connected between driver and gate by soldering the two J2 areas together.

Fig.1 shows a simplified block diagram of the SKHI10 driver. Some preliminary remarks will help the understanding:

- Regulated +15V must be present between pins 8,9 (V_S) and 10,11 (\perp); an input signal (ON or OFF command to the IGBTs) from the control system is supplied to pin 2 (V_{in}) where HIGH=ON and LOW=OFF.
- Pin 5 (V_{CE}) at secondary side is normally connected to the collector of the IGBT to monitor V_{CE} , but for initial tests without connecting the IGBT it must be connected to pin 1 (E) to avoid ERROR signal and enable the output signals to be measured.
- The RESET input must be connected to 0V to enable the V_{in} signal. If it is left opened, the driver will be blocked.
- To monitor the error signal, a pull-up resistor must be provided between pin 3 (ERROR) and V_S .

B. Description of the Circuit Block Diagram (Fig. 1)

The circuit in Fig. 1 shows the input on the left and output on the right (primary/secondary).

1. Input level circuit

This circuit was designed to accept two different logic voltage levels. The standard level is +15V (factory adjusted) intended for noisy environments or when long connections ($l > 50$ cm) between the external control circuit and SKHI10 are used, where noise immunity must be considerable. For lower power, and short connections between control and driver, the TTL-HCMOS level (+5V)

can be selected by carefully soldering the small areas of J1 together, specially useful for signals coming from μP based controllers.

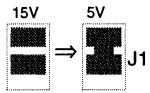

Fig.3 Selecting J1 for 5V level (TTL)

When connecting the SKHI10 to a control board using short connections no special attention needs to be taken (Fig. 4a).

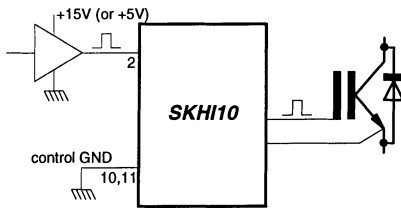

Fig.4a Connecting the SKHI10 with short cable

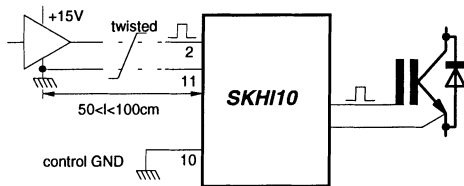

Fig.4b Connecting the SKHI10 with long cable

Otherwise, if the length is 50cm or more (we suggest to limit the cable length to about 1 meter), some care must be taken. The TTL level should be avoided and CMOS/15V is to be used instead; flat cable must have the pairs of conductors twisted or be shielded to reduce EMI/RFI susceptibility (Fig. 4b). If a shielded cable is used, it can be connected to pin 1. It is coupled to 0V through a resistor (0 Ω).

As the input impedance of the INPUT LEVEL SELECTOR circuit is very high, an internal pull-down resistor keeps the IGBT in OFF state in case the V_{in} connection is interrupted or left non connected.

2. Input buffer

This circuit enables and amplifies the input signal V_{in} to be transferred to the pulse transformer when RESET (pin 4) is LOW and also prevents spurious signals being transmitted to the secondary side.

The following overview is showing the input threshold voltages

V_{IT+} (High)	min	typ	max
15 V	9,5 V	11,0 V	12,5 V
5 V	1,8 V	2,0 V	2,4 V

V_{IT-} (Low)	min	typ	max
15 V	3,6 V	4,2 V	4,8 V
5 V	0,50 V	0,65 V	0,80 V

3. Error memory and reset signal

The ERROR memory is triggered only by following events:

- short circuit of IGBTs
- V_S undervoltage

In case of short circuit, the V_{CE} monitor sends a trigger signal (fault signal) through the impulse transformer to a FLIP-FLOP on the primary side giving the information to an open-collector transistor (pin 3), which may be connected to the external control circuit as ERROR message in HIGH logic (or LOW if J3 is short-circuited). If V_S power supply falls below 13V for more than 0,5ms, the same FLIP-FLOP is set and pin 3 is activated. For HIGH logic (default), an external R_C must be connected preferentiattly in the control main board. In this way the connection between main board and driver is also checked.

If low-logic version is used (J3 short-circuited), an internal pull-up resistor (internally connected to V_S) is provided, and the signal from more SKHI10s can be connected together to perform an wired-or-circuit.

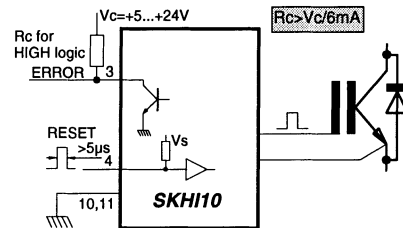

Fig.5 Driver status information ERROR, and RESET

The ERROR signal may be disabled either by RESET=HIGH (pin4) or by switching the power supply (V_S) off. The width of the RESET pulse must be more than 5 μs , and in case of interrupted connection an internal pull-up resistor will act.

FAULT	RESET	ERROR ¹⁾	V_{in}
no	0	0	enable
no	1	0	disable
yes	0	1	disable
yes	1	0	disable

1) default logic (HIGH); for LOW logic the signals are complementary

Table 1 ERROR signal truth table

The open-collector transistor (pin 3) may be connected through a pull-up resistor to an external (internal V_S for the "low-logixc" version) voltage supply +5V...+24V, limiting the current to $I_{sink} \leq 6mA$.

4. Power supply (Vs) monitor

The supply voltage V_S is monitored. If it falls below 13V an ERROR signal is generated and the turn-on pulses for the IGB's gate are blocked.

5. Pulse transformer

It transmits the turn-on and turn-off signals to the IGBT. In the reverse direction the ERROR signal from the V_{CE} monitoring is transmitted via the same transformer. The isolation is 4 kV.

6. DC/DC converter

In the primary side of the converter, a half-bridge inverter transfers the necessary energy from V_S to the secondary of a ferrite transformer. In the secondary side, a full bridge and filters convert the high frequency signal coming from the primary to DC levels (+15V/- 8V) that are stabilised by a voltage regulator circuit.

7. Output buffer

The output buffer is supplied by the +15V/- 8V from the DC/DC converter. If the operation proceeds normally (no fault), the on- and off-signal is transmitted to the gate of an IGBT through R_{gon} and R_{goff} . The output stage has a MOSFET pair that is able to source/sink up to 8A peak current to/from the gate improving the turn-on/off time of the IGBT. Additionally, we can select I_{Rgoff} (see Fig. 2) either to discharge the gate capacitance with a voltage source (standard) or with a current source, specially design for the 1700V IGBT series (it speeds up the turn-off time of the IGBT). The present factory setting is voltage source ($I_{Rgoff} = 0\Omega$). Using the current source I_{Rgoff} , R_{goff} must be 0 Ω .

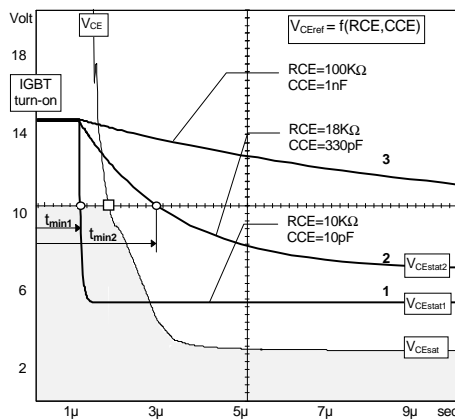

Fig.6 V_{CEref} waveform with parameters R_{CE} , C_{CE}

8. Soft turn-off

In case of short-circuit, a further circuit (SOFT TURN-OFF) increases the resistance in series with R_{goff} and turns-off the IGBT at a lower speed. This produces a smaller voltage spike (due $LSTRAY \times di/dt$) above the DC link by reducing the di/dt value. Because in short-circuit conditions the Homogeneous IGBT's peak current increases up to 8 times the nominal current (up to 10 times with Epitaxial IGBT structures), and some stray inductance is ever present in power circuits, it must fall to zero in a longer time than at normal operation. This "soft

turn-off time" can be reduced by connecting a parallel resistor $R_{goff-SC}$ (see Fig. 2) with those already on the printed circuit board.

9. V_{CE} monitoring

This circuit is responsible for short-circuit sensing. Due to the direct measurement of V_{CEstat} on the IGBT's collector, it blocks the output buffer (through the soft turn-off circuit) in case of short-circuit and sends a signal to the ERROR memory on the primary side. The recognition of which V_{CE} level must be considered as a short circuit event, is adjusted by R_{CE} and C_{CE} (see Fig. 2), and it depends of the IGBT used. Typical values $R_{CE} = 18k\Omega$ and $C_{CE} = 330$ pF for SKHI 10 are delivered from factory (Fig. 6, curve 2). Using SKHI 10/17 the driver will be delivered with $R_{CE} = 36$ k Ω and $C_{CE} = 470$ pF from factory.

The V_{CEref} is not static but a dynamic reference which has an exponential shape starting at about 15V and decreases to V_{CEstat} ($5V \leq V_{CEstat} \leq 10V$ determined by R_{CE}), with a time constant τ ($0,5 \mu s \leq \tau \leq 1$ ms controlled by C_{CE}). The V_{CEstat} must be adjusted to remain above V_{CEsat} in normal operation (the IGBT is already in full saturation).

To avoid a false failure indication when the IGBT just starts to conduct (V_{CEsat} value is still too high) some decay time must be provided for the V_{CEref} . As the V_{CE} signal is internally limited at 10V, the decay time of V_{CEref} must reach this level after V_{CE} or a failure indication will occur (see Fig.6, curve 1). A t_{min} is defined as function of V_{CEstat} and τ to find out the best choice for R_{CE} and V_{CE} (see Fig.6, curve 2). The time the IGBT come to the 10V (represented by a „□“ in Fig. 6) depends on the IGBT itself and R_{gon} used.

The R_{CE} and C_{CE} values can be found from Fig. 7 by taking the V_{CEstat} and t_{min} as input values with following remarks:

- $R_{CE} > 10k\Omega$
- $C_{CE} < 2,7nF$

Attention!: If this function is not used, for example during the experimental phase, the V_{CE} MONITORING must be connected with the EMITTER output to avoid possible fault indication and consequent gate signal blocking.

10. R_{gon} , R_{goff}

These two resistors are responsible for the switching speed of each IGBT. As an IGBT has input capacitance (varying during the switching time) which must be charged and discharged, both resistors will dictate what time must be taken to do this. The final value of resistance is difficult to predict, because it depends on many parameters, as follows:

- DC-link voltage
- stray inductance of the circuit
- switching frequency
- type of IGBT

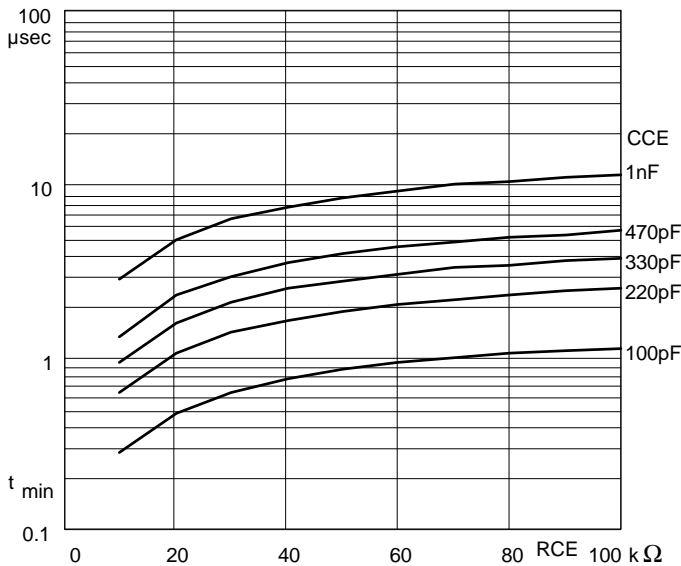

Fig.7a t_{min} as function of R_{CE} and C_{CE}

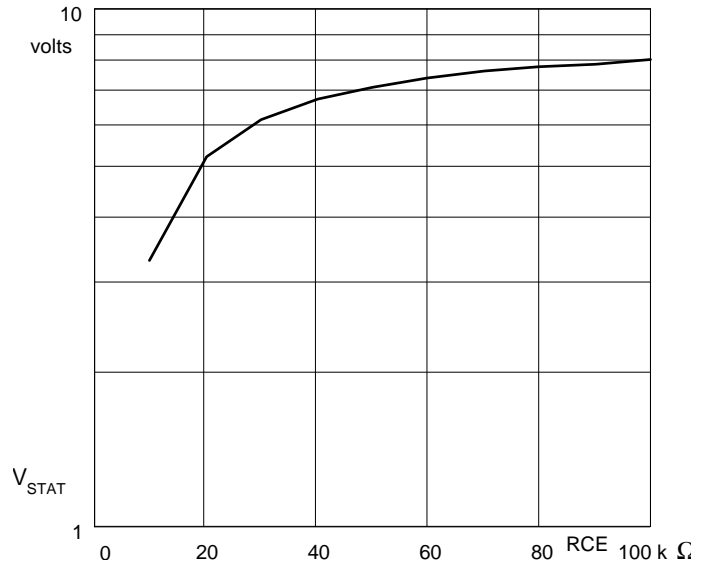

Fig.7b V_{CEstat} as function of R_{CE}

C. Operating Procedure

1. One IGBT connection

To realize the correct switching and short-circuit monitoring of one IGBT some additional external components must be used (Fig.8).

The driver is delivered with four R_g resistors (43 Ω). This value can be reduced to use the driver with bigger modules or higher frequencies/lower voltages, by putting additional resistors in parallel to the existing ones.

The outputs G_{on} and G_{off} were previewed to connect the driver with more than one IGBT (paralleling). In that case we need both signals ON/OFF separately to connect additional external resistors R_{gon} and R_{goff} for each IGBT. If only one IGBT is to be used, we suggest to connect both points together through J2 (see Fig. 1 and 2). This can be done by soldering the two small pads together, which saves one external connection.

Typical component values: *)

SK-IGBT-Module	R_{Gon} Ω	R_{Goff} Ω	C_{CE} pF	R_{CE} kW	I_{Rgoff} Ω
SKM 75GAL123D	22	22	330	18	0
SKM 100GAL(R)123D	15	15	330	18	0
SKM 150GAL(R)123D	12	12	330	18	0
SKM 200GA(L/R)123D	10	10	330	18	0
SKM 300GA(L/R)123D	8,2	8,2	330	18	0
SKM 400GA123D	6,8	6,8	330	18	0
SKM 500GA123D	5,6	5,6	330	18	0

Table 2a 1200V IGBT@ DC-link< 700V

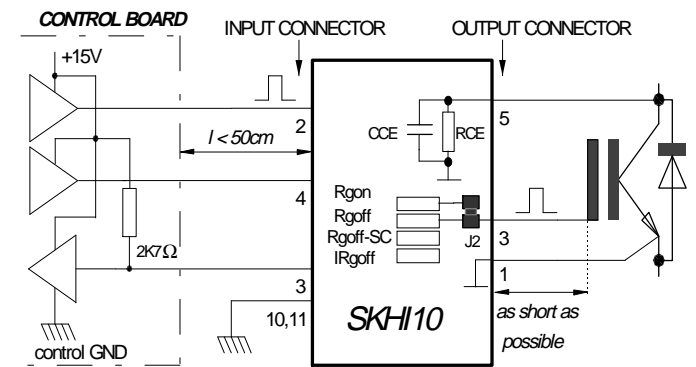

Fig. 8 Preferred standard circuit

SK-IGBT-Module	R_{Gon} Ω	R_{Goff} Ω	C_{CE} pF	R_{CE} kW	I_{Rgoff} Ω
SKM 200GAL173D	8,2	8,2	470	36	0
SKM 300GA173D	6,8	6,8	470	36	0
SKM 400GA173	5,6	5,6	470	36	0

Table 2b 1700V IGBT@ DC-link< 1000V

*) Only starting values, for final optimization.

The adjustment of R_{goffSC} (factory adjusted $R_{goffSC} = 22 \Omega$) should be done observing the overvoltages at the module in case of short circuit. When having a low inductive DC-link the module can be switched off faster.

The values shown should be considered as standard values for a mechanical/electrical assembly, with acceptable stray inductance level, using only one IGBT per SKHI10 driver. The final optimized value can be found only by measuring.

2. Paralleling IGBTs

The parallel connection is recommended only by using IGBTs with homogeneous structure (IGHT), that have a positive temperature coefficient resulting in a perfect

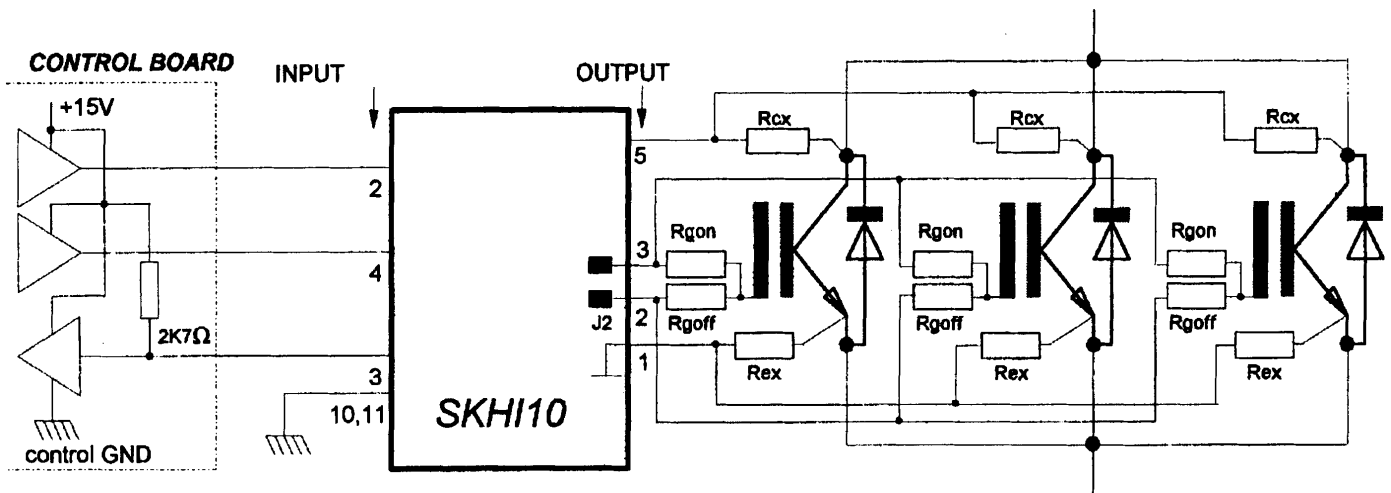

Fig. 9 Preferred circuit for paralleled IGBT's

current sharing without any external auxiliary element. After all some care must be considered to reach an optimized circuit and to obtain the total performance of the IGBT (Fig. 9). The IGBTs must have independent values of R_{gon} and R_{goff} . An auxiliary emitter resistor R_e as well as an auxiliary collector resistor R_c must also be used.

The external resistors R_{gonx} , R_{goffx} , R_{ex} and R_{cx} should be mounted on an additional circuit board near the paralleled modules, and the R_{gon}/R_{goff} on the driver should be changed to zero ohms.

The R_{ex} assumes a value of $0,5\Omega$ and its function is to compensate the wiring resistance in the auxiliary emitters what could make the emitter voltage against ground unbalanced.

The R_{cx} assumes a value of 47Ω and its function is to create an average value of V_{CEsat} in case of short circuit for V_{CE} monitoring.

The Mechanical assembly of the power circuit must be symmetrical and low inductive.

The maximum recommended gate charge is $9,6\mu C$.

See als Fig.14.

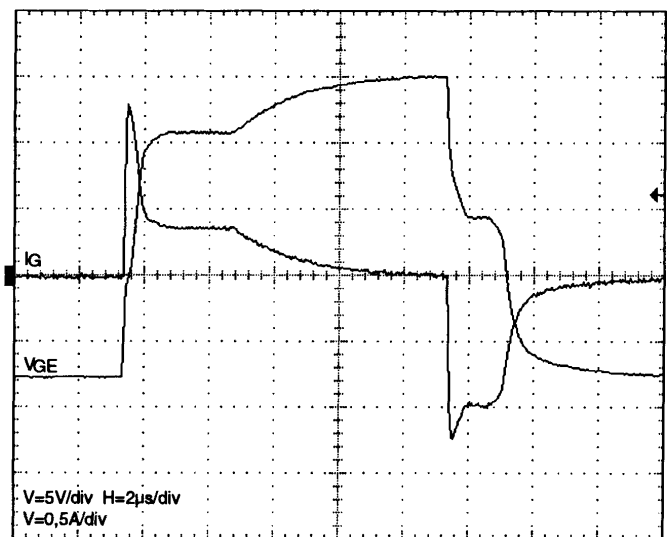

Fig. 11 Output voltage (V_{GE}) and output current (I_G)

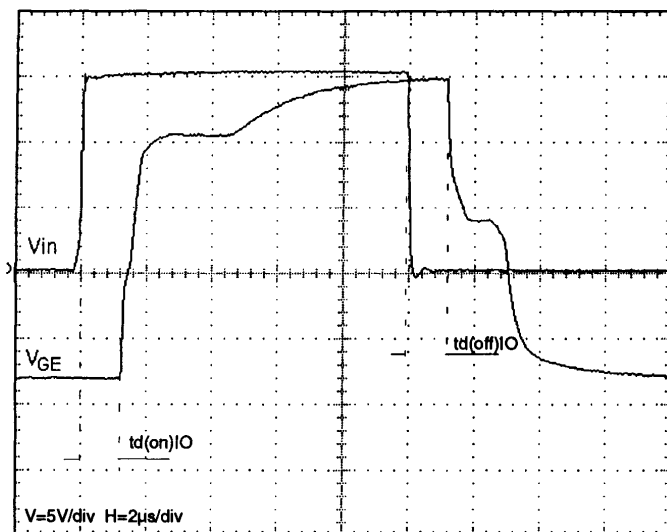

Fig. 10 Input and output voltage propagation time

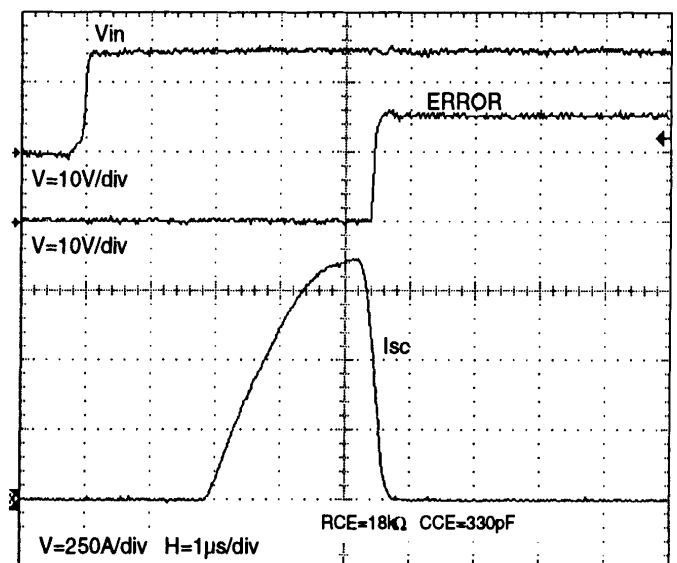

Fig. 12 Short-circuit and ERROR propagation time worst-case (V_{in} with SC already present)

D. Signal Waveforms

The following signal waveforms were measured under the conditions below:

- $V_S = 15\text{ V}$
- $T_{\text{amb}} = 25\text{ °C}$
- load = SKM150GAL161D
- $R_{\text{CE}} = 18\text{ k}\Omega$
- $C_{\text{CE}} = 330\text{ pF}$
- $U_{\text{DC}} = 1200\text{ V}$
- $I_C = 100\text{ A}$

All results are typical values if not otherwise specified.

The limit frequency of SKH10 depends on the gate charge connected in this output pins.

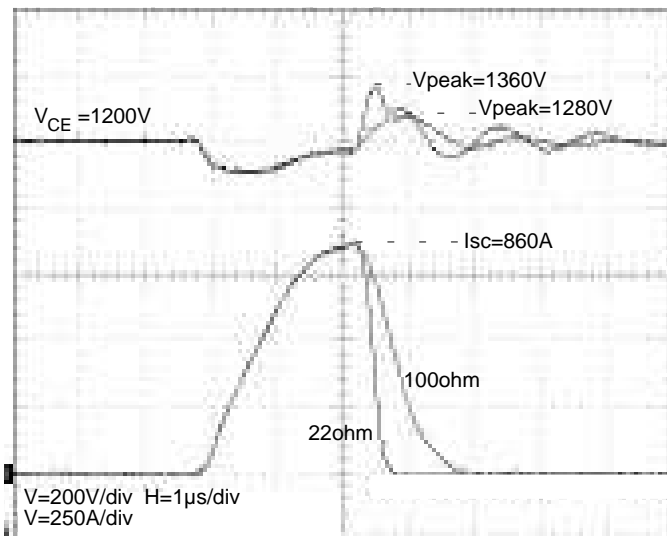

Fig.13 Effect of $R_{\text{goff-SC}}$ in short - circuit

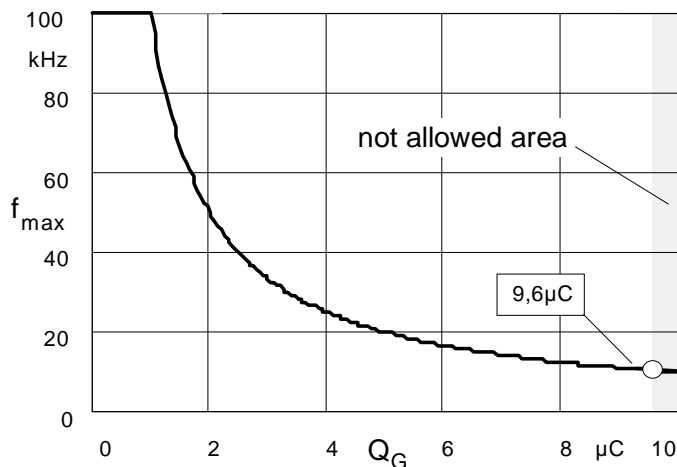

Fig.14 Maximum operating frequency x gate charge

If small IGBT modules are used, the frequency could theoretically reach 100kHz. For bigger modules or even paralleled modules, the maximum frequency must be determinate (Fig. 14). Q_G is the total equivalent gate charge connected to the output of the driver. The maximum allowed value is limited ($9,6\mu\text{C}$), and depends on the output internal capacitance connected to the power supply (energy storage capacitance).

E. Application / Handling

1. The CMOS inputs of the driver are extremely sensitive to overvoltage. Voltages higher than ($V_S + 0,3\text{ V}$) or under $-0,3\text{ V}$ may destroy these inputs.

Therefore the following safety requirements are to be observed:

- To make sure that the control signals do not comprise overvoltages exceeding the above values.
- Protection against static discharges during handling. As long as the hybrid driver is not completely assembled the input terminals must be short circuited. Persons working with CMOS devices should wear a grounded bracelet. Any floor coverings must not be chargeable. For transportation the input terminals must be short circuited using, for example, conductive rubber. Places of work must be grounded. The same foam requirements apply to the IGBTs.

2. The connecting leads between the driver and the power module must be as short as possible, and should be twisted.

3. Any parasitic inductance should be minimized. Overvoltages may be damped by C or RCD snubber networks between the main terminals [3] = C1 (+) and [2] = E2 (-) of the power module.

4. When first operating a newly developed circuit, low collector voltage and load current should be used in the beginning. These values should be increased gradually, observing the turn-off behavior of the free-wheeling diodes and the turn-off voltage spikes across the IGBT by means of an oscilloscope. Also the case temperature of the power module should be monitored. When the circuit works correctly, short circuit tests can be made, starting again with low collector voltage.

5. It is important to feed any ERROR back to the control circuit to switch the equipment off immediately in such events. Repeated turn-on of the IGBT into a short circuit, with a frequency of several kHz, may destroy the device.

For further details ask SEMIKRON

Nr.11224040