

Visualisation; Diagnostics

Easy to Configure

Programming IEC 61131-3

Rapid Installation

PNOZ mmc1p

PILZ
THE SPIRIT OF SAFETY

- ▶ Configurable compact control systems PNOZmulti Mini

This document is a translation of the original document.

All rights to this documentation are reserved by Pilz GmbH & Co. KG. Copies may be made for internal purposes. Suggestions and comments for improving this documentation will be gratefully received.

Source code from third-party manufacturers or open source software has been used for some components. The relevant licence information is available on the Internet on the Pilz homepage.

Pilz®, PIT®, PMI®, PNOZ®, Primo®, PSEN®, PSS®, PVIS®, SafetyBUS p®, SafetyEYE®, SafetyNET p®, the spirit of safety® are registered and protected trademarks of Pilz GmbH & Co. KG in some countries.



SD means Secure Digital

Section 1	Introduction	5
	1.1 Validity of documentation	5
	1.2 Using the documentation	5
	1.3 Definition of symbols	5
Section 2	Overview	7
	2.1 Scope of supply	7
	2.2 Unit features	7
	2.3 Front view	7
Section 3	Safety	9
	3.1 Intended use	9
	3.2 System requirements	9
	3.3 Safety regulations	10
	3.3.1 Use of qualified personnel	10
	3.3.2 Warranty and liability	10
	3.3.3 Disposal	10
	3.3.4 For your safety	10
Section 4	Function description	11
	4.1 Unit properties	11
	4.2 Block diagram	11
Section 5	Installation	12
	5.1 General installation guidelines	12
	5.2 Dimensions	12
	5.3 Connect the base unit and expansion modules	13
Section 6	Commissioning	14
	6.1 General wiring guidelines	14
	6.2 Preparing for operation	14
	6.2.1 Download modified project to the PNOZmulti safety system	14
	6.3 Ethernet interfaces	15
	6.3.1 RJ45 interfaces ("Ethernet")	15
	6.3.2 Requirements of the connection cable and connector	15
	6.3.3 Interface configuration	15
	6.3.4 RJ45 connection cable	16
	6.3.5 Process data exchange	17
Section 7	Operation	18
	7.1 Messages	18
	7.1.1 Display elements for device diagnostics	18
	7.2 Reset Ethernet connection settings	19

Section 8	Technical details	20
Section 9	Order reference	22
	9.1 Product	22
	9.2 Accessories	22

1 Introduction

1.1 Validity of documentation

This documentation is valid for the product PNOZ mmc1p. It is valid until new documentation is published.

This operating manual explains the function and operation, describes the installation and provides guidelines on how to connect the product.

1.2 Using the documentation

This document is intended for instruction. Only install and commission the product if you have read and understood this document. The document should be retained for future reference.

1.3 Definition of symbols

Information that is particularly important is identified as follows:



DANGER!

This warning must be heeded! It warns of a hazardous situation that poses an immediate threat of serious injury and death and indicates preventive measures that can be taken.



WARNING!

This warning must be heeded! It warns of a hazardous situation that could lead to serious injury and death and indicates preventive measures that can be taken.



CAUTION!

This refers to a hazard that can lead to a less serious or minor injury plus material damage, and also provides information on preventive measures that can be taken.



NOTICE

This describes a situation in which the product or devices could be damaged and also provides information on preventive measures that can be taken. It also highlights areas within the text that are of particular importance.

**INFORMATION**

This gives advice on applications and provides information on special features.

2 Overview

2.1 Scope of supply

- ▶ Expansion module PNOZ mmc1p
- ▶ Jumper

2.2 Unit features

Using the product PNOZ mmc1p:

Communication module for connection to a base unit from the configurable control systems PNOZmultiMini.

The product has the following features:

- ▶ Can be configured in the PNOZmulti Configurator
- ▶ 2 Ethernet interfaces
- ▶ Status indicators for supply voltage, communication and errors
- ▶ Max. 1 communication module can be connected to the left of the base unit PNOZmulti Mini

2.3 Front view

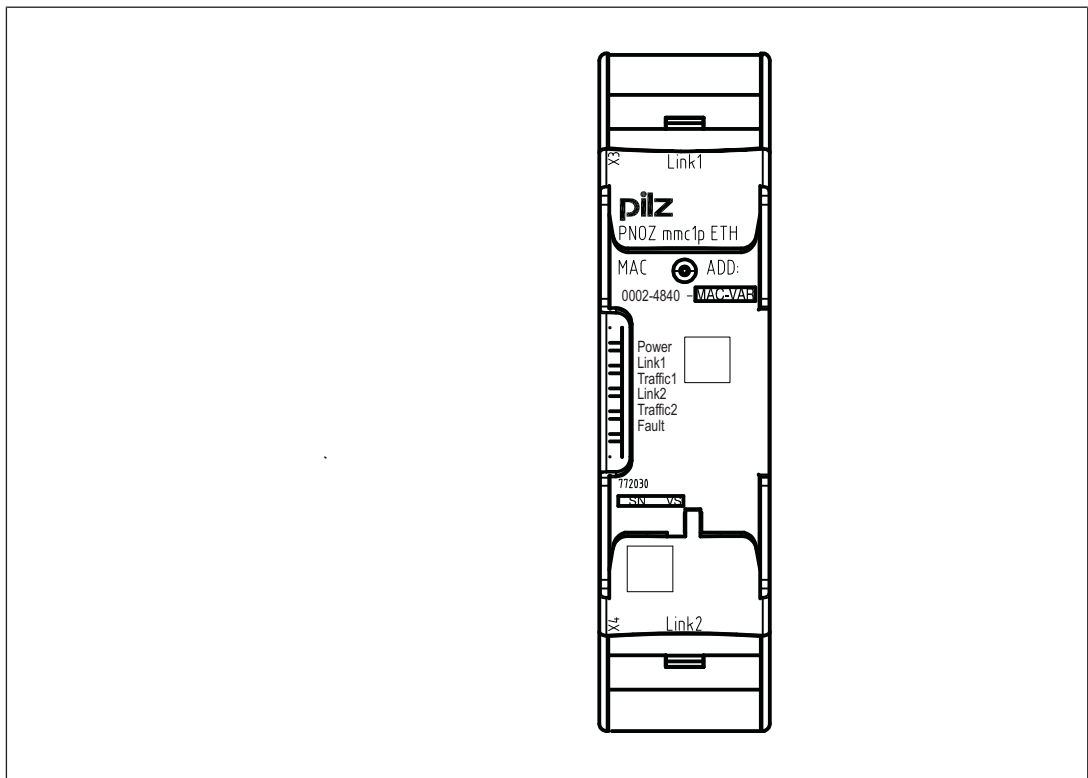

Legend:

- ▶ Link1, Link2:
Ethernet interfaces

- ▶ LEDs:
 - Power
 - Link1
 - Traffic1
 - Link2
 - Traffic2
 - Fault

3 Safety

3.1 Intended use

The expansion module PNOZ mmc1p is used for communication of the configurable control systems PNOZmulti Mini via Ethernet.

The expansion module may only be connected to a base unit PNOZmulti Mini (for details of the base units PNOZmulti Mini

that can be connected, refer to the document "PNOZmulti System Expansion").

The configurable small control systems PNOZmulti are used for the safety-related interruption of safety circuits and are designed for use in:

- ▶ E-STOP equipment
- ▶ Safety circuits in accordance with VDE 0113 Part 1 and EN 60204-1

The expansion module may not be used for safety-related functions.

The following is deemed improper use in particular:

- ▶ Any component, technical or electrical modification to the product
- ▶ Use of the product outside the areas described in this manual
- ▶ Use of the product outside the technical details (see [Technical details](#) [ 20]).



NOTICE

EMC-compliant electrical installation

The product is designed for use in an industrial environment. The product may cause interference if installed in other environments. If installed in other environments, measures should be taken to comply with the applicable standards and directives for the respective installation site with regard to interference.

3.2 System requirements

Please refer to the "Product Modifications PNOZmulti" document in the "Version overview" section for details of which versions of the base unit and PNOZmulti Configurator can be used for this product.

3.3 Safety regulations

3.3.1 Use of qualified personnel

The products may only be assembled, installed, programmed, commissioned, operated, maintained and decommissioned by competent persons.

A competent person is someone who, because of their training, experience and current professional activity, has the specialist knowledge required to test, assess and operate the work equipment, devices, systems, plant and machinery in accordance with the general standards and guidelines for safety technology.

It is the company's responsibility only to employ personnel who:

- ▶ Are familiar with the basic regulations concerning health and safety / accident prevention
- ▶ Have read and understood the information provided in this description under "Safety"
- ▶ And have a good knowledge of the generic and specialist standards applicable to the specific application.

3.3.2 Warranty and liability

All claims to warranty and liability will be rendered invalid if

- ▶ The product was used contrary to the purpose for which it is intended
- ▶ Damage can be attributed to not having followed the guidelines in the manual
- ▶ Operating personnel are not suitably qualified
- ▶ Any type of modification has been made (e.g. exchanging components on the PCB boards, soldering work etc.).

3.3.3 Disposal

- ▶ When decommissioning, please comply with local regulations regarding the disposal of electronic devices (e.g. Electrical and Electronic Equipment Act).

3.3.4 For your safety

The unit meets all the necessary conditions for safe operation. However, you should always ensure that the following safety requirements are met:

- ▶ This operating manual only describes the basic functions of the unit. The expanded functions are described in the PNOZmulti Configurator's online help. Only use these functions once you have read and understood the documentations.
- ▶ Do not open the housing or make any unauthorised modifications.
- ▶ Please make sure you shut down the supply voltage when performing maintenance work (e.g. exchanging contactors).

4 Function description

4.1 Unit properties

The product PNOZ mmc1p has two Ethernet interfaces to

- ▶ Download the project
- ▶ Read the diagnostic data
- ▶ Set virtual inputs for standard functions
- ▶ Read virtual outputs for standard functions

via Ethernet (TCP/IP, Modbus/TCP).

Information on diagnostics via the Ethernet interfaces can be found in the document entitled "PNOZmulti Mini communication interfaces".

The connection to Ethernet is made via the two 8-pin RJ45 sockets.

The Ethernet interface is configured in the PNOZmulti Configurator and is described in the online help for the PNOZmulti Configurator.

4.2 Block diagram

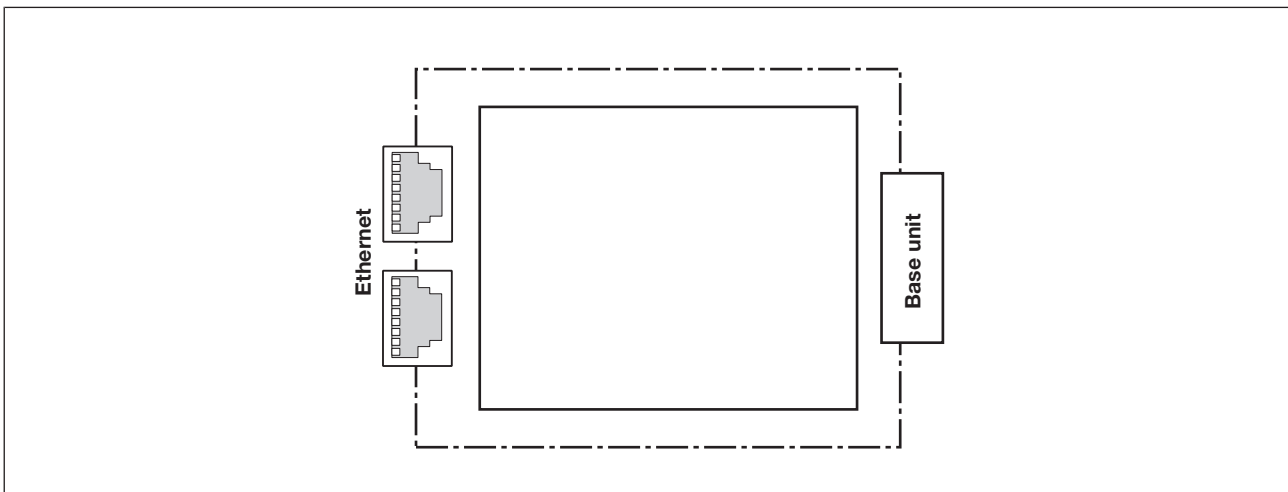

5 Installation

5.1 General installation guidelines

- ▶ The unit should be installed in a control cabinet with a protection type of at least IP54.
- ▶ Fit the safety system to a horizontal mounting rail. The venting slots must face upwards and downwards. Other mounting positions could destroy the safety system.
- ▶ Use the notch on the rear of the unit to attach it to a mounting rail.
- ▶ In environments exposed to heavy vibration, the unit should be secured using a fixing element (e.g. retaining bracket or end angle).
- ▶ Push the unit upwards or downwards before lifting it from the mounting rail.
- ▶ To comply with EMC requirements, the mounting rail must have a low impedance connection to the control cabinet housing.
- ▶ The ambient temperature of the PNOZmulti units in the control cabinet must not exceed the figure stated in the technical details, otherwise air conditioning will be required.



NOTICE

Damage due to electrostatic discharge!

Electrostatic discharge can damage components. Ensure against discharge before touching the product, e.g. by touching an earthed, conductive surface or by wearing an earthed armband.

5.2 Dimensions

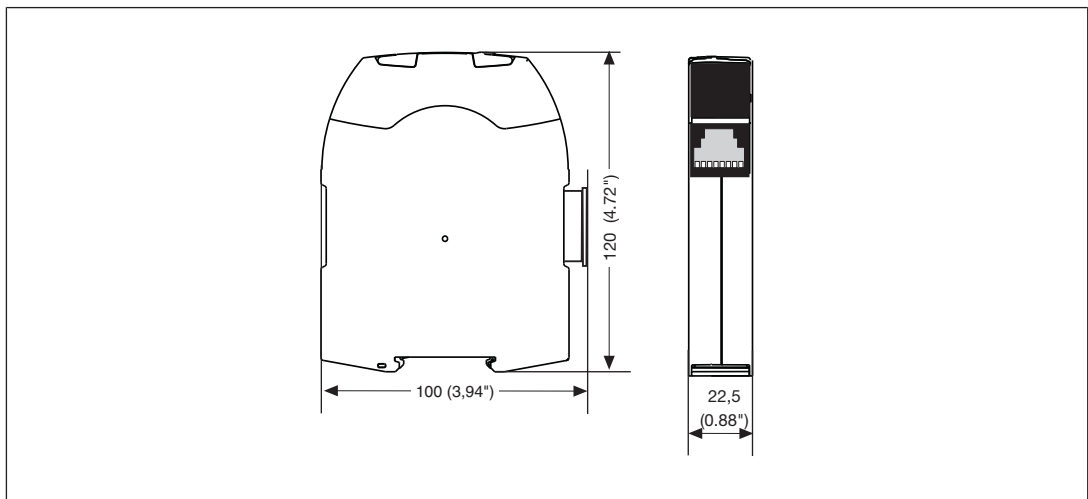

5.3 Connect the base unit and expansion modules

Connect the base unit and the expansion module as described in the operating instructions for the base units.

- ▶ Connect the black/yellow terminator to the expansion module.
- ▶ Install the expansion module in the position in which it is configured in the PNOZmulti Configurator.

The position of the expansion modules is defined in the PNOZmulti Configurator. The expansion modules are connected to the left or right of the base unit, depending on the type.

Please refer to the document "PNOZmulti System Expansion" for details of the number of modules that can be connected to the base unit and the module types.

6 Commissioning

6.1 General wiring guidelines

The wiring is defined in the circuit diagram of the PNOZmulti Configurator.

Please note:

- ▶ Information given in the [Technical details](#) [ 20] must be followed.
- ▶ Use copper wire that can withstand 75° C.

6.2 Preparing for operation

Detection and activation of the Ethernet interface, depending on the USB interface on the base unit:

- ▶ **USB interface on the base unit not connected**

If the USB interface on the base unit is not connected, the Ethernet interface will be detected and activated by the base unit as soon as the communication module has been connected to the base unit.

- ▶ **USB interface on the base unit connected**

If the USB interface on the base unit is already connected, the "Ethernet" interface will first need to be selected on the base unit display to enable the Ethernet interface on the base unit to be detected and activated (see operating manual for the base unit for details of the setting).

6.2.1 Download modified project to the PNOZmulti safety system

As soon as an additional expansion module has been connected to the system, the project must be amended using the PNOZmulti Configurator. Proceed as described in the operating instructions for the base unit.

**NOTICE**

For the commissioning and after every program change, you must check whether the safety devices are functioning correctly.

6.3 Ethernet interfaces

6.3.1 RJ45 interfaces ("Ethernet")

Two free switch ports are provided as Ethernet interfaces via an internal autosensing switch. The autosensing switch automatically detects whether data transfer is occurring at 10 Mbit/s or 100 Mbit/s.



INFORMATION

The connected subscribers must support the autosensing/autonegotiation function. If not, the communication partner must be set permanently to "10 Mbit/s, half duplex".

The switch's automatic crossover function means there is no need to distinguish on the connection cable between patch cable (uncrossed data line connection) and crossover cable (crossover data line connection). The switch automatically creates the correct data line connection internally. Patch cable can therefore be used as the connection cable for end devices as well as cascading.

Both Ethernet interfaces use RJ45 technology.

6.3.2 Requirements of the connection cable and connector

The following minimum requirements must be met:

- ▶ Ethernet standards (min. Category 5) 10BaseT or 100BaseTX
- ▶ Double-shielded twisted pair cable for industrial Ethernet use
- ▶ Shielded RJ45 connectors (industrial connectors)

6.3.3 Interface configuration

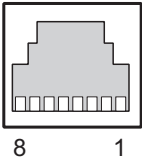
RJ45 socket 8-pin	PIN	Standard	Crossover
	1	TD+ (Transmit+)	RD+ (Receive+)
	2	TD- (Transmit-)	RD- (Receive-)
	3	RD+ (Receive+)	TD+ (Transmit+)
	4	n.c.	n.c.
	5	n.c.	n.c.
	6	RD- (Receive-)	TD- (Transmit-)
	7	n.c.	n.c.
	8	n.c.	n.c.

6.3.4 RJ45 connection cable

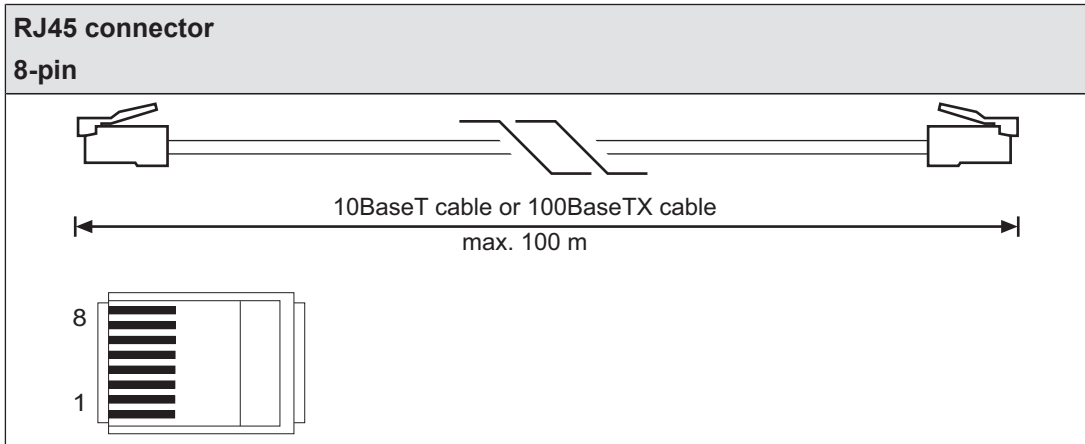
**NOTICE**

With the plug-in connection please note that the data cable and connector have a limited mechanical load capacity. Appropriate design measures should be used to ensure that the plug-in connection is insensitive to increased mechanical stress (e.g. through shock, vibration). Such measures include fixed routing with strain relief, for example.

6.3.5 Process data exchange

The RJ45 interfaces on the internal autosensing switch enable process data to be exchanged with other Ethernet subscribers within a network.

The product PNOZ mmc1p can also be connected to Ethernet via a hub (hub or switch).

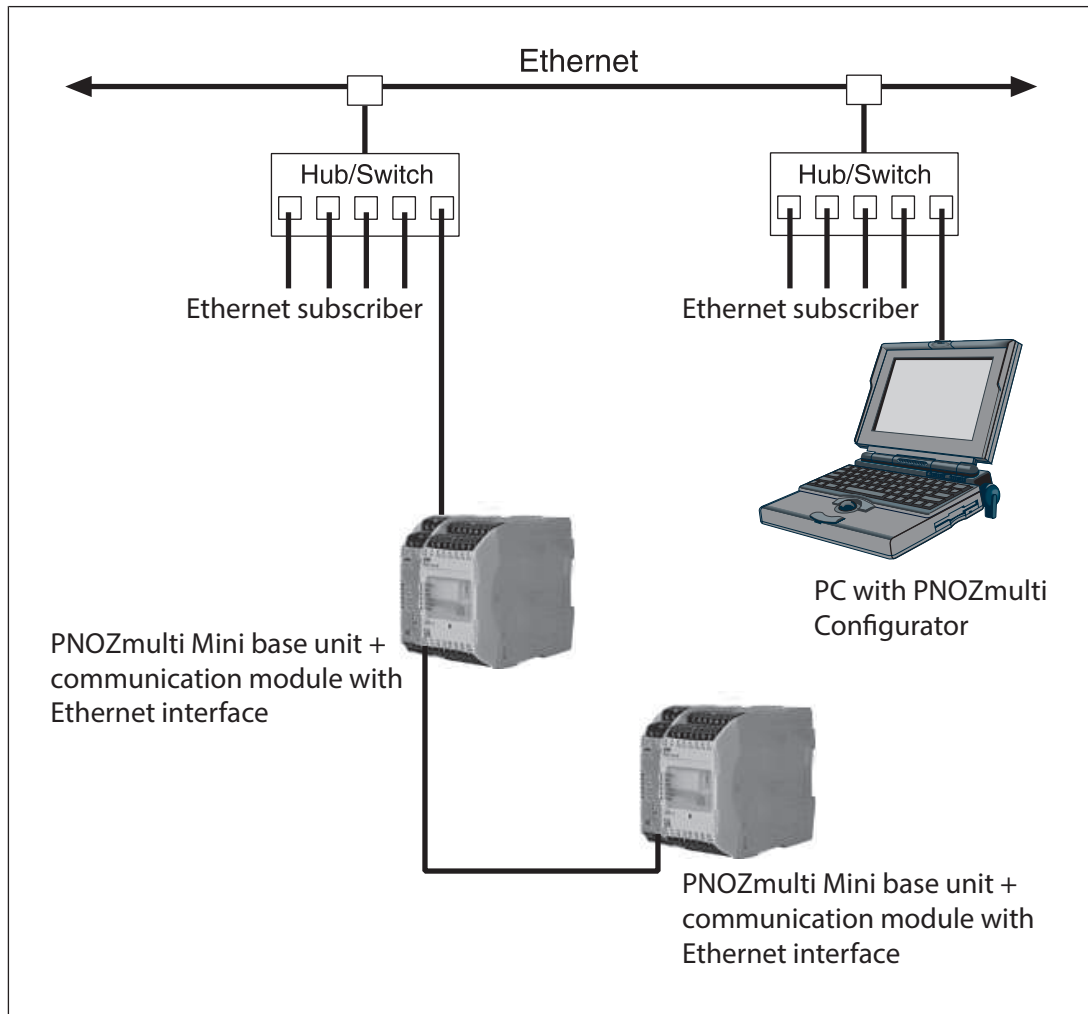

Fig.: PNOZmulti as Ethernet subscriber - possible topologies

7 Operation

7.1 Messages



When the supply voltage is switched on, the PNOZmulti safety system copies the configuration from the chip card.















The LEDs "POWER", "DIAG", "FAULT", "IFAULT" and "OFAULT" will light up on the base unit.

The safety system PNOZmulti is ready for operation when the "POWER" and "RUN" LEDs on the base unit and the "POWER" LED on the PNOZ mmc1p are lit continuously.

7.1.1 Display elements for device diagnostics

Legend

-  LED on
-  LED flashes
-  LED off

LED	LED status		Meaning
Power			No supply voltage
		Green	Supply voltage is present
Link1			No network connection at Link1
		Green	Network connection available at Link1
Link2			No network connection at Link2
		Green	Network connection available at Link2
Traffic1			No data traffic at Link1
		Yellow	Data traffic available at Link1
Traffic2			No data traffic at Link2
		Yellow	Data traffic available at Link2
Fault		Red	Internal error
		Red	No connection to base unit
		Orange	The unit could not be assigned an IP address by the DHCP Server.
		Orange	The unit is waiting for the DHCP Server to assign an IP address

7.2 **Reset Ethernet connection settings**

The Ethernet connection settings of the base unit can be configured in the PNOZmulti Configurator.

You can reset the base unit's Ethernet connection settings to the default settings.

Proceed as follows:

- ▶ Switch off the supply voltage
- ▶ Remove the chip card
- ▶ Restart the base unit without the chip card inserted.

The Ethernet connection settings are now reset to the default settings.

8 Technical details

General	
Approvals	CCC, CE, EAC (Eurasian), KCC, cULus Listed
Electrical data	
Supply voltage	
for	Module supply
internal	Via base unit
Voltage	3,3 V
Kind	DC
Voltage tolerance	-2 %/+2 %
Power consumption	1,0 W
Status indicator	LED
Ethernet interface	
Number	2
Fieldbus interface	
Fieldbus interface	Modbus TCP
Device type	Slave
Connection	RJ45
Galvanic isolation	yes
Environmental data	
Ambient temperature	
In accordance with the standard	EN 60068-2-14
Temperature range	0 - 60 °C
Storage temperature	
In accordance with the standard	EN 60068-2-1/-2
Temperature range	-25 - 70 °C
Climatic suitability	
In accordance with the standard	EN 60068-2-30, EN 60068-2-78
Humidity	93 % r. h. at 40 °C
Condensation during operation	Not permitted
EMC	EN 61131-2
Vibration	
In accordance with the standard	EN 60068-2-6
Frequency	10,0 - 150,0 Hz
Acceleration	1g
Shock stress	
In accordance with the standard	EN 60068-2-27
Acceleration	15g
Duration	11 ms
Max. operating height above sea level	2000 m
Airgap creepage	
Overvoltage category	II
Pollution degree	2
Rated insulation voltage	30 V

Environmental data	
Protection type	
In accordance with the standard	EN 60529
Mounting area (e.g. control cabinet)	IP54
Housing	IP20
Terminals	IP20
Mechanical data	
Mounting position	Horizontal on top hat rail
DIN rail	
Top hat rail	35 x 7,5 EN 50022
Recess width	27 mm
Max. cable length	
Max. cable length per input	0,1 km
Material	
Bottom	PC
Front	PC
Top	PC
Dimensions	
Height	100,0 mm
Width	22,5 mm
Depth	120,0 mm
Weight	100 g

Where standards are undated, the 07/2010 latest editions shall apply.

9 Order reference

9.1 Product

Product type	Features	Order No.
PNOZ mmc1p ETH	Expansion module	772 030

9.2 Accessories

Terminator, jumper

Product type	Features	Order No.
PNOZ s terminator plug	Terminator, yellow, 10 pieces	750 010
PNOZ s connector	Jumper, 10 pieces	750 020

► Support

Technical support is available from Pilz round the clock.

Americas

Brazil
+55 11 97569-2804

Canada
+1 888-315-PILZ (315-7459)

Mexico
+52 55 5572 1300

USA (toll-free)
+1 877-PILZUSA (745-9872)

Asia

China
+86 21 60880878-216

Japan
+81 45 471-2281

South Korea
+82 31 450 0680

Australia

+61 3 95446300

Europe

Austria
+43 1 7986263-0

Belgium, Luxembourg
+32 9 3217575

France
+33 3 88104000

Germany
+49 711 3409-444

Ireland
+353 21 4804983

Italy
+39 0362 1826711

Scandinavia

+45 74436332

Spain

+34 938497433

Switzerland

+41 62 88979-30

The Netherlands

+31 347 320477

Turkey

+90 216 5775552

United Kingdom

+44 1536 462203

You can reach our international hotline on:

+49 711 3409-444
support@pilz.com

Pilz develops environmentally-friendly products using ecological materials and energy-saving technologies. Offices and production facilities are ecologically designed, environmentally-aware and energy-saving. So Pilz offers sustainability, plus the security of using energy-efficient products and environmentally-friendly solutions.

Energy saving by Pilz



Pilz GmbH & Co. KG
Felix-Wankel-Straße 2
73760 Ostfildern, Germany
Tel.: +49 711 3409-0
Fax: +49 711 3409-133
info@pilz.com
www.pilz.com

PILZ
THE SPIRIT OF SAFETY