

Hyperfast Rectifier, 30 A FRED Pt® G5

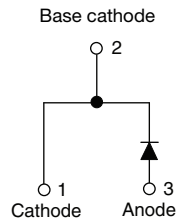

TO-220AC 2L



FEATURES

- Best in class forward voltage drop and switching losses trade off
- Optimized for high speed operation
- 175 °C maximum operating junction temperature
- Polyimide passivation
- AEC-Q101 qualified, meets JESD 201 class 1A whisker test
- Material categorization: for definitions of compliance please see www.vishay.com/doc?99912



RoHS
COMPLIANT
HALOGEN
FREE

LINKS TO ADDITIONAL RESOURCES



3D Models

PRIMARY CHARACTERISTICS

$I_{F(AV)}$	30 A
V_R	600 V
V_F at I_F at 125 °C	1.15 V
t_{rr} (typ.)	25 ns
T_J max.	175 °C
Package	TO-220AC 2L
Circuit configuration	Single

DESCRIPTION / APPLICATIONS

Featuring a unique combination of low conduction and switching losses, this rectifier is the right choice for soft switched and resonant converters, as well as medium frequency hard switching converters. This device is specifically designed to improve efficiency of high speed LLC output rectification stages of EV / HEV on-board battery chargers

MECHANICAL DATA

Case: TO-220AC 2L

Molding compound meets UL 94 V-0 flammability rating

ABSOLUTE MAXIMUM RATINGS

PARAMETER	SYMBOL	TEST CONDITIONS	VALUES	UNITS
Repetitive peak reverse voltage	V_{RRM}		600	V
Average rectified forward current	$I_{F(AV)}$	$T_C = 113\text{ °C}$, $D = 0.50$	30	A
Repetitive peak forward current	I_{FRM}	$T_C = 113\text{ °C}$, $D = 0.50$, $f = 20\text{ kHz}$	60	
Non-repetitive peak surge current	I_{FSM}	$T_C = 25\text{ °C}$, $t_p = 10\text{ ms}$, sine wave	330	
Operating junction and storage temperature	T_J , T_{Stg}		-55 to +175	°C

ELECTRICAL SPECIFICATIONS ($T_J = 25\text{ °C}$ unless otherwise specified)

PARAMETER	SYMBOL	TEST CONDITIONS	MIN.	TYP.	MAX.	UNITS
Breakdown voltage, blocking voltage	V_{BR} , V_R	$I_R = 100\text{ }\mu\text{A}$	600	-	-	V
Forward voltage	V_F	$I_F = 30\text{ A}$	-	1.3	1.6	
		$I_F = 30\text{ A}$, $T_J = 125\text{ °C}$	-	1.15	-	
Reverse leakage current	I_R	$V_R = V_R$ rated	-	-	20	μA
		$T_J = 125\text{ °C}$, $V_R = V_R$ rated	-	-	500	
Junction capacitance	C_T	$V_R = 200\text{ V}$	-	36	-	pF
Series inductance	L_S	Measured to lead 5 mm from package body	-	8	-	nH



DYNAMIC RECOVERY CHARACTERISTICS ($T_J = 25\text{ }^\circ\text{C}$ unless otherwise specified)						
PARAMETER	SYMBOL	TEST CONDITIONS	MIN.	TYP.	MAX.	UNITS
Reverse recovery time	t_{rr}	$I_F = 1.0\text{ A}, dI_F/dt = 100\text{ A}/\mu\text{s}, V_R = 30\text{ V}$	-	25	-	ns
		$T_J = 25\text{ }^\circ\text{C}$	-	41	-	
		$T_J = 125\text{ }^\circ\text{C}$	-	58	-	
Peak recovery current	I_{RRM}	$T_J = 25\text{ }^\circ\text{C}$	-	19	-	A
		$T_J = 125\text{ }^\circ\text{C}$	-	32	-	
Reverse recovery charge	Q_{rr}	$T_J = 25\text{ }^\circ\text{C}$	-	419	-	nC
		$T_J = 125\text{ }^\circ\text{C}$	-	1176	-	
Reverse recovery time	t_{rr}	$T_J = 25\text{ }^\circ\text{C}$	-	46	-	ns
		$T_J = 125\text{ }^\circ\text{C}$	-	65	-	
Peak recovery current	I_{RRM}	$T_J = 25\text{ }^\circ\text{C}$	-	21	-	A
		$T_J = 125\text{ }^\circ\text{C}$	-	36	-	
Reverse recovery charge	Q_{rr}	$T_J = 25\text{ }^\circ\text{C}$	-	550	-	nC
		$T_J = 125\text{ }^\circ\text{C}$	-	1560	-	

THERMAL - MECHANICAL SPECIFICATIONS						
PARAMETER	SYMBOL	TEST CONDITIONS	MIN.	TYP.	MAX.	UNITS
Thermal resistance, junction-to-case	R_{thJC}		-	-	1.3	$^\circ\text{C}/\text{W}$
Weight			-	2.0	-	g
			-	0.07	-	oz.
Mounting torque			6.0 (5.0)	-	12 (10)	kgf · cm (lbf · in)
Maximum junction and storage temperature range	T_J, T_{Stg}		-55	-	175	$^\circ\text{C}$
Marking device		Case style TO-220AC 2L	E5TH3006TH			

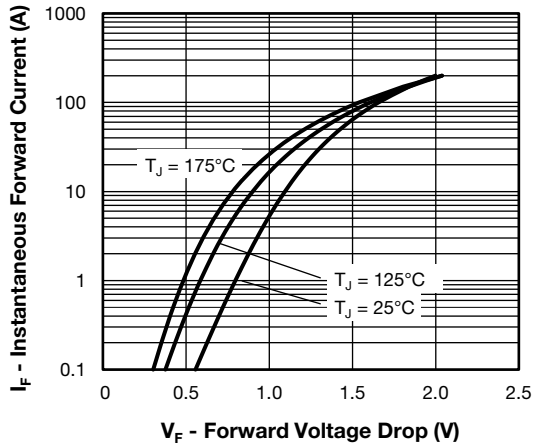

Fig. 1 - Forward Voltage Drop Characteristics, Per Leg

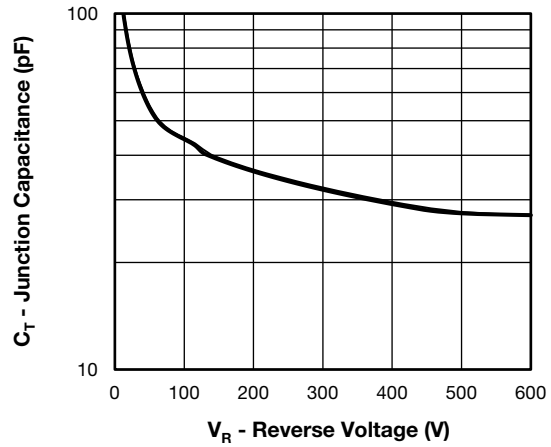

Fig. 3 - Typical Junction Capacitance vs. Reverse Voltage, Per Leg

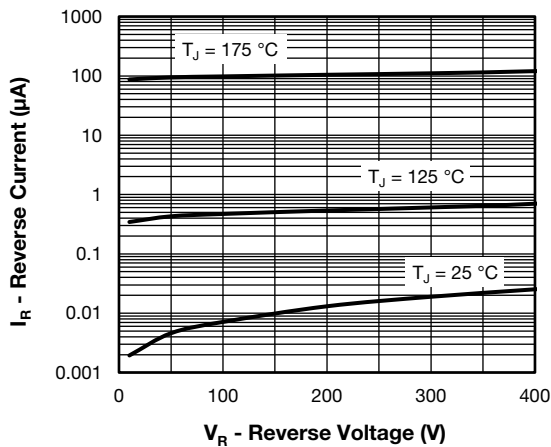

Fig. 2 - Typical Values of Reverse Current vs. Reverse Voltage, Per Leg

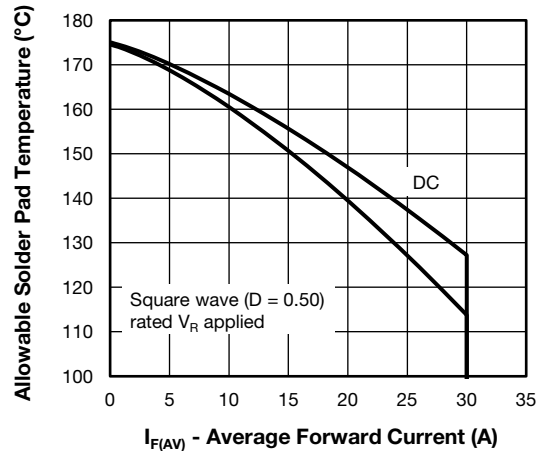

Fig. 4 - Maximum Allowable Case Temperature vs. Average Forward Current, Per Leg

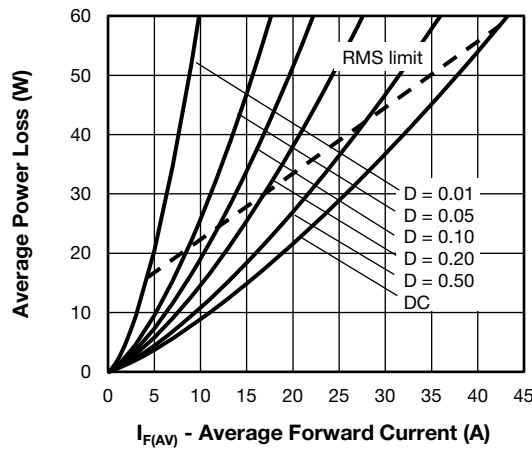

Fig. 5 - Forward Power Loss Characteristics, Per Leg

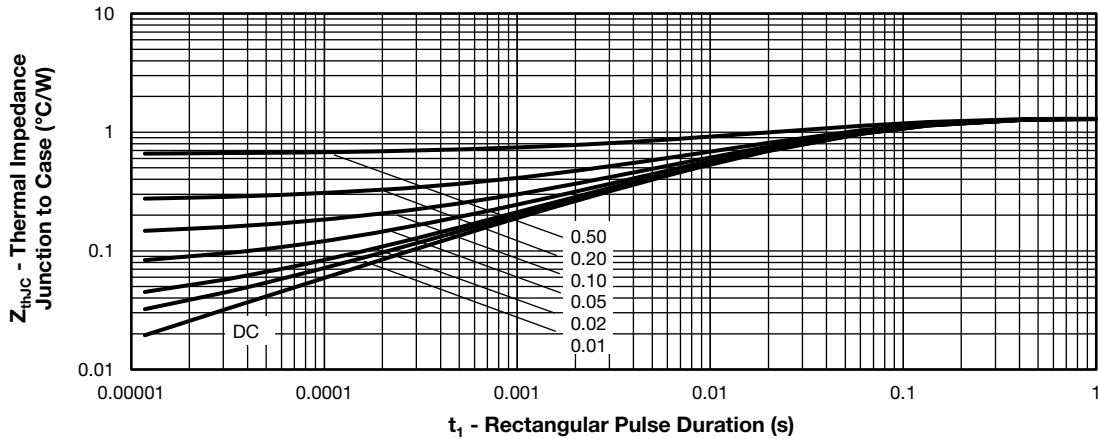

Fig. 6 - Transient Thermal Impedance, Junction to Case, Per Leg

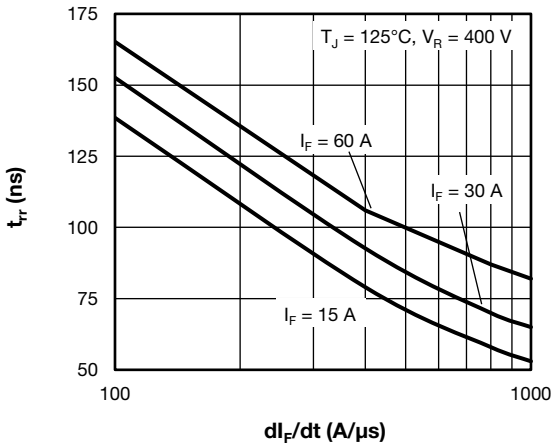

Fig. 7 - Typical Reverse Recovery Time vs. dI_F/dt , Per Leg

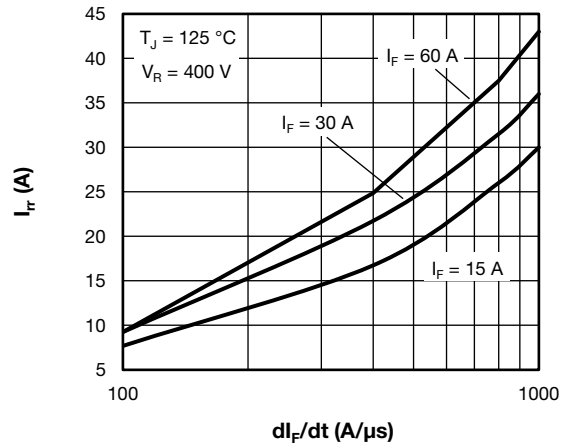

Fig. 9 - Typical Reverse Recovery Current vs. dI_F/dt , Per Leg

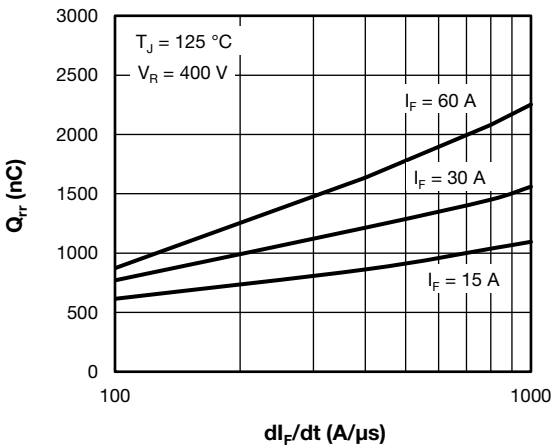

Fig. 8 - Typical Reverse Recovery Charge vs. dI_F/dt , Per Leg

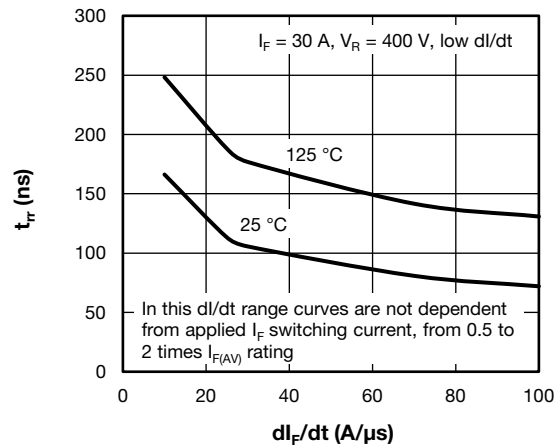

Fig. 10 - Typical Reverse Recovery Time vs. dI_F/dt , Per Leg

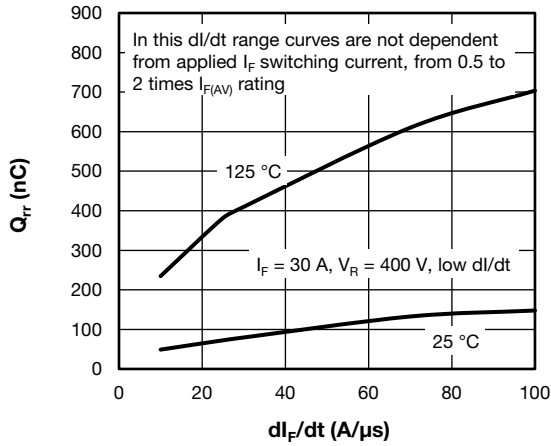

Fig. 11 - Typical Reverse Recovery Charge vs. di_F/dt , Per Leg

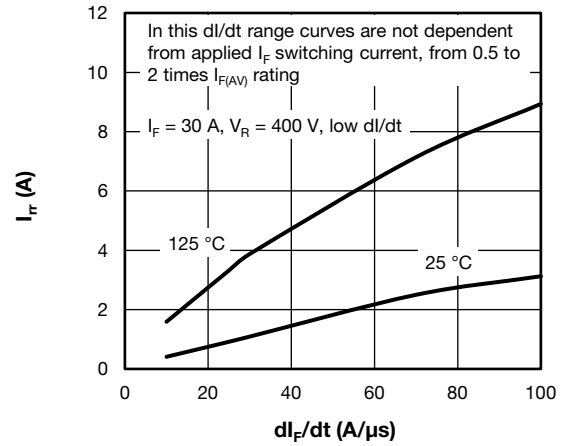

Fig. 12 - Typical Reverse Recovery Current vs. di_F/dt , Per Leg

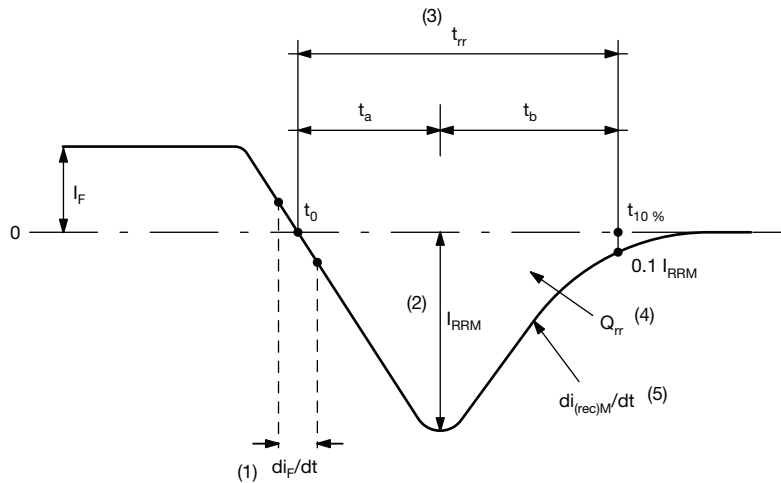

Fig. 13 - Reverse Recovery Waveform and Definitions

Notes

- (1) di_F/dt - rate of change of current through zero crossing
- (2) I_{RRM} - peak reverse recovery current
- (3) t_{rr} - reverse recovery time measured from t_0 , crossing point of negative going I_F , to point $t_{10\%}$, $0.1 I_{RRM}$
- (4) Q_{rr} - area under curve defined by t_0 and $t_{10\%}$

$$Q_{rr} = \int_{t_0}^{t_{10\%}} I(t) dt$$

- (5) $di_{(rec)M}/dt$ - peak rate of change of current during t_b portion of t_{rr}



ORDERING INFORMATION TABLE

Device code	VS-	E	5	T	H	30	06	T	H	N3
	1	2	3	4	5	6	7	8	9	10
	1	-	Vishay Semiconductors product							
	2	-	E = single diode							
	3	-	5 = FRED generation 5							
	4	-	Package: T = TO-220AC package							
	5	-	H = hyperfast recovery							
	6	-	Current rating (30 = 30 A)							
	7	-	Voltage rating (06 = 600 V)							
	8	-	T = true pin TO-220							
	9	-	H = AEC-Q101 qualified							
	10	-	Environmental digit: N3 = halogen-free, RoHS-compliant, and totally lead (Pb)-free							

ORDERING INFORMATION (Example)			
PREFERRED P/N	QUANTITY PER TUBE	MINIMUM ORDER QUANTITY	PACKAGING DESCRIPTION
VS-E5TH3006THN3	50	1000	Antistatic plastic tube

LINKS TO RELATED DOCUMENTS	
Dimensions	www.vishay.com/doc?96069
Part marking information	www.vishay.com/doc?95391
SPICE model	www.vishay.com/doc?96919

2L TO-220AC

DIMENSIONS in millimeters and inches

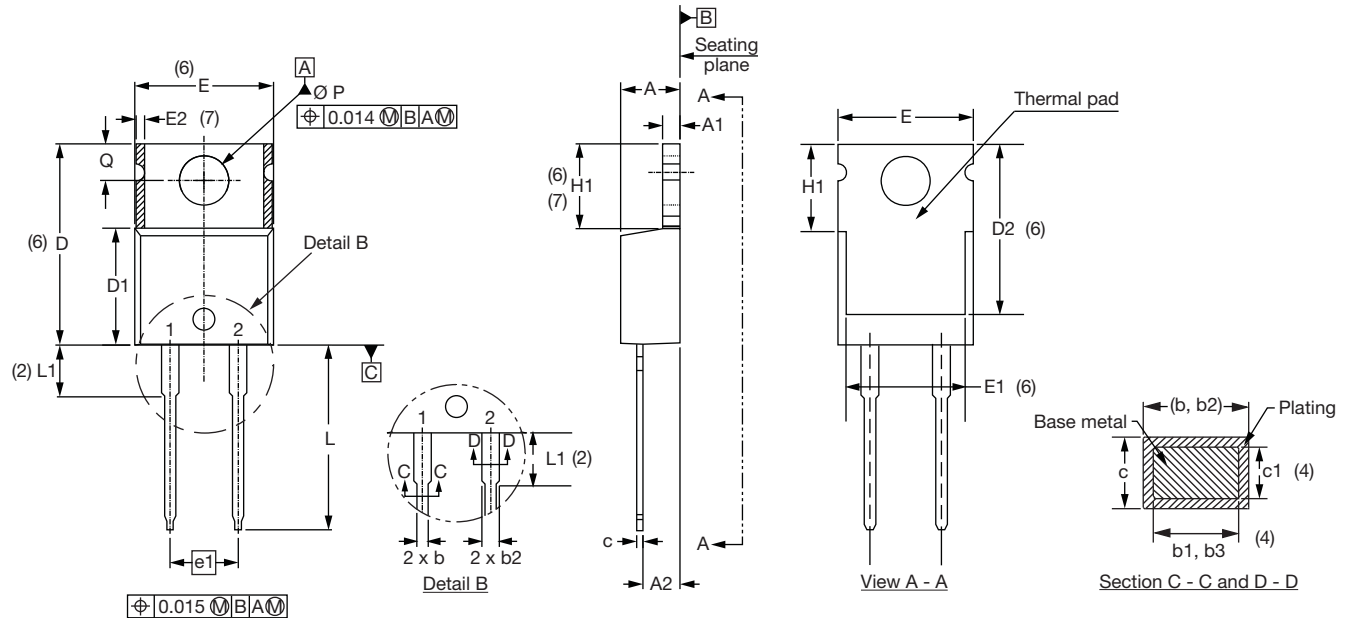

SYMBOL	MILLIMETERS		INCHES		NOTES
	MIN.	MAX.	MIN.	MAX.	
A	4.25	4.65	0.167	0.183	
A1	1.14	1.40	0.045	0.055	
A2	2.56	2.92	0.101	0.115	
b	0.69	1.01	0.027	0.040	
b1	0.38	0.97	0.015	0.038	4
b2	1.20	1.73	0.047	0.068	
b3	1.14	1.73	0.045	0.068	4
c	0.36	0.61	0.014	0.024	
c1	0.36	0.56	0.014	0.022	4
D	14.85	15.25	0.585	0.600	3
D1	8.38	9.02	0.330	0.355	
D2	11.68	12.88	0.460	0.507	6
E	10.11	10.51	0.398	0.414	3, 6

SYMBOL	MILLIMETERS		INCHES		NOTES
	MIN.	MAX.	MIN.	MAX.	
E1	6.86	8.89	0.270	0.350	6
E2	-	0.76	-	0.030	7
e1	4.88	5.28	0.192	0.208	
H1	5.84	6.86	0.230	0.270	6, 7
L	13.52	14.02	0.532	0.552	
L1	3.32	3.82	0.131	0.150	2
ϕP	3.54	3.73	0.139	0.147	
Q	2.60	3.00	0.102	0.118	

Notes

- (1) Dimensioning and tolerancing as per ASME Y14.5M-1994
- (2) Lead dimension and finish uncontrolled in L1
- (3) Dimension D, D1 and E do not include mold flash. Mold flash shall not exceed 0.127 mm (0.005") per side. These dimensions are measured at the outermost extremes of the plastic body
- (4) Dimension b1, b3 and c1 apply to base metal only
- (5) Controlling dimension: inches
- (6) Thermal pad contour optional within dimensions E, H1, D2 and E1
- (7) Dimension E2 x H1 define a zone where stamping and singulation irregularities are allowed
- (8) Outline conforms to JEDEC® TO-220, except D2, where JEDEC® minimum is 0.480"



Disclaimer

ALL PRODUCT, PRODUCT SPECIFICATIONS AND DATA ARE SUBJECT TO CHANGE WITHOUT NOTICE TO IMPROVE RELIABILITY, FUNCTION OR DESIGN OR OTHERWISE.

Vishay Intertechnology, Inc., its affiliates, agents, and employees, and all persons acting on its or their behalf (collectively, "Vishay"), disclaim any and all liability for any errors, inaccuracies or incompleteness contained in any datasheet or in any other disclosure relating to any product.

Vishay makes no warranty, representation or guarantee regarding the suitability of the products for any particular purpose or the continuing production of any product. To the maximum extent permitted by applicable law, Vishay disclaims (i) any and all liability arising out of the application or use of any product, (ii) any and all liability, including without limitation special, consequential or incidental damages, and (iii) any and all implied warranties, including warranties of fitness for particular purpose, non-infringement and merchantability.

Statements regarding the suitability of products for certain types of applications are based on Vishay's knowledge of typical requirements that are often placed on Vishay products in generic applications. Such statements are not binding statements about the suitability of products for a particular application. It is the customer's responsibility to validate that a particular product with the properties described in the product specification is suitable for use in a particular application. Parameters provided in datasheets and / or specifications may vary in different applications and performance may vary over time. All operating parameters, including typical parameters, must be validated for each customer application by the customer's technical experts. Product specifications do not expand or otherwise modify Vishay's terms and conditions of purchase, including but not limited to the warranty expressed therein.

Hyperlinks included in this datasheet may direct users to third-party websites. These links are provided as a convenience and for informational purposes only. Inclusion of these hyperlinks does not constitute an endorsement or an approval by Vishay of any of the products, services or opinions of the corporation, organization or individual associated with the third-party website. Vishay disclaims any and all liability and bears no responsibility for the accuracy, legality or content of the third-party website or for that of subsequent links.

Except as expressly indicated in writing, Vishay products are not designed for use in medical, life-saving, or life-sustaining applications or for any other application in which the failure of the Vishay product could result in personal injury or death. Customers using or selling Vishay products not expressly indicated for use in such applications do so at their own risk. Please contact authorized Vishay personnel to obtain written terms and conditions regarding products designed for such applications.

No license, express or implied, by estoppel or otherwise, to any intellectual property rights is granted by this document or by any conduct of Vishay. Product names and markings noted herein may be trademarks of their respective owners.