

Interference Suppression Film Capacitor - Class X2 Axial MKT 253 V_{AC} - Continuous Across the Line

FEATURES

- Axial mounting
- Low building height
- Material categorization:
for definitions of compliance please see www.vishay.com/doc?99912



RoHS
COMPLIANT
HALOGEN
FREE
GREEN
(5-2008)

APPLICATIONS

High stability grade for continuous across the line X2 applications.

See also application note: www.vishay.com/doc?28153

QUICK REFERENCE DATA	
Capacitance range (E12 series)	0.01 μ F to 2.2 μ F (preferred values according to E6)
Capacitance tolerance	0.01 μ F to \leq 0.1 μ F: \pm 20 % 0.12 μ F to \leq 2.2 μ F: \pm 10 %
Rated AC voltage	253 V _{AC} ; 50 Hz to 60 Hz
Permissible DC voltage	630 V _{DC}
Climatic testing class (according to IEC 60068-1)	C \leq 1.0 μ F = 40 / 100 / 21 / C C > 1.0 μ F = 40 / 085 / 21 / C
Maximum application temperature	100 °C
Leads	Tinned wire
Reference standards	IEC 60384-14 ed-4 (2013) and EN 60384-14, UL 60384-14, CSA E384-14
Dielectric	Polyester film
Electrodes	Metallized
Construction	Series construction
Encapsulation	Plastic, epoxy resin sealed, flame retardant UL-class 94 V-0
Marking	C-value; tolerance; rated voltage; sub-class; manufacturer's type; code for dielectric material; manufacturer location, year and week; manufacturer's logo or name; safety approvals

Note

- For more detailed data and test requirements, contact rfi@vishay.com

DIMENSIONS in millimeters	
LEAD DIAMETER d_t	D
0.7 \pm 0.07	\leq 7
0.8 \pm 0.08	> 7 to < 16.5
1.0 \pm 0.1	\geq 16.5

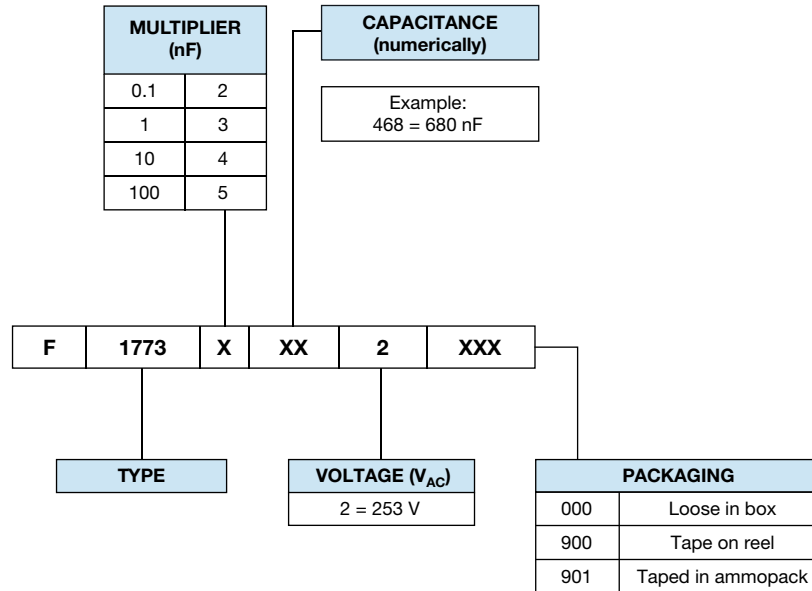
COMPOSITION OF CATALOG NUMBER

Note

- For detailed tape specifications refer to "Packaging information" www.vishay.com/doc?28139 or end of catalog





SPECIFIC REFERENCE DATA	
DESCRIPTION	VALUE
Rated AC voltage (U_{RAC})	253 V
Permissible DC voltage (U_{RDC})	630 V
Tangent of loss angle	$\leq 100 \times 10^{-4}$ at 1 kHz
Rated voltage pulse slope (dU/dt) _R at 350 V _{DC}	
L 19 mm	200 V/ μ s
L 26.5 mm	150 V/ μ s
L 31.5 mm	100 V/ μ s
L 41.5 mm	100 V/ μ s
R between leads, for $C \leq 0.33 \mu$ F at 100 V; 1 min	$> 15\,000 \text{ M}\Omega$
RC between leads, for $C > 0.33 \mu$ F at 100 V; 1 min	$> 5000 \text{ s}$
R between leads and case; 100 V; 1 min	$> 30\,000 \text{ M}\Omega$
Withstanding (AC) voltage between leads and cover	2000 V; -1 min
Withstanding (DC) voltage (cut off current 10 mA); rise time 100 V/s	1200 V; 1 min
Maximum application temperature	100 °C



ELECTRICAL DATA AND ORDERING CODE							
U _{RAC} (V)	CAP. (μF)	TOLERANCE (%)	PITCH (mm)	DIMENSIONS D x L (mm)	MASS (g)	SPQ ⁽¹⁾ (pieces)	ORDERING CODE ⁽²⁾
253	d_t = 0.70 mm ± 0.07 mm						
	0.010	± 20	22.5	6.0 x 19.0	0.9	1500	F17733102000
	0.012	± 20	22.5	6.0 x 19.0	0.9	1500	F17733122000
	0.015	± 20	22.5	6.0 x 19.0	0.9	1500	F17733152000
	0.018	± 20	22.5	6.0 x 19.0	0.9	1500	F17733182000
	0.022	± 20	22.5	6.0 x 19.0	0.9	1500	F17733222000
	0.027	± 20	22.5	6.0 x 19.0	0.9	1500	F17733272000
	0.033	± 20	22.5	6.0 x 19.0	0.9	1500	F1773332000
	0.039	± 20	22.5	6.5 x 19.0	1.0	1500	F17733392000
	0.047	± 20	22.5	7.0 x 19.0	1.1	1500	F17733472000
	d_t = 0.80 mm ± 0.08 mm						
	0.056	± 20	22.5	8.0 x 19.0	1.6	1500	F17733562000
	0.068	± 20	22.5	8.0 x 19.0	1.6	1500	F17733682000
	0.082	± 20	22.5	9.0 x 19.0	1.8	1500	F17733822000
	0.10	± 20	22.5	9.5 x 19.0	2.0	1000	F17734102000
	0.12	± 10	22.5	10.5 x 19.0	2.2	1000	F17734122000
	0.15	± 10	30.0	8.5 x 26.5	2.2	1000	F17734152000
	0.18	± 10	30.0	9.5 x 26.5	2.6	1000	F17734182000
	0.22	± 10	30.0	10.0 x 26.5	2.8	1000	F17734222000
	0.27	± 10	30.0	11.0 x 26.5	3.3	750	F17734272000
	0.33	± 10	30.0	12.0 x 26.5	3.8	750	F17734332000
	0.39	± 10	30.0	13.0 x 26.5	4.7	750	F17734392000
	0.47	± 10	30.0	14.0 x 26.5	5.5	1250	F17734472000
	0.56	± 10	35.0	14.0 x 31.5	6.2	1000	F17734562000
	0.68	± 10	35.0	15.0 x 31.5	6.7	1000	F17734682000
	d_t = 1.0 mm ± 0.1 mm						
	0.82	± 10	35.0	16.5 x 31.5	8.3	750	F17734822000
	1.0	± 10	35.0	18.0 x 31.5	9.5	750	F17735102000
1.2	± 10	35.0	19.5 x 31.5	11.0	500	F17735122000	
1.5	± 10	45.0	18.0 x 41.5	13.5	500	F17735152000	
1.8	± 10	45.0	19.5 x 41.5	15.7	450	F17735182000	
2.2	± 10	45.0	21.5 x 41.5	17.8	400	F17735222000	

Notes

- For detailed tape specifications refer to packaging information: www.vishay.com/doc?28139 or end of catalog
- ⁽¹⁾ SPQ = Standard Packing Quantity
- ⁽²⁾ These capacitors can be delivered on continuous tape and reel; the ordering code is F1773...2900 taped on reel, F1773...2901 taped ammpack

APPROVALS				
SAFETY APPROVALS X2	VOLTAGE	VALUE	FILE NUMBERS	LINK
EN 60384-14 (ENEC) (= IEC 60384-14 ed-4 (2013))	253 V _{AC}	0.01 µF to 2.2 µF X2	40005089	www.vishay.com/doc?28222
UL 60384-14	253 V _{AC}	0.01 µF to 2.2 µF X2	E354331	www.vishay.com/doc?28223
CSA E384-14	253 V _{AC}	0.01 µF to 2.2 µF X2	1913342	www.vishay.com/doc?28224
CB Test-Certificate	253 V _{AC}	0.01 µF to 2.2 µF X2	DE 1-7470	www.vishay.com/doc?28221
The ENEC-approval together with the CB-Certificate replace all national marks of the following countries (they have already signed the ENEC-Agreement): Austria; Belgium; Czech Republic; Denmark; Finland; France; Germany; Greece; Hungary; Ireland; Italy; Luxembourg; Netherlands; Norway; Portugal; Slovenian; Spain; Sweden; Switzerland and United Kingdom.				
   				

MOUNTING

Normal Use

The capacitors are designed for mounting on printed-circuit boards. The capacitors packed in bandoliers are designed for mounting in printed-circuit boards by means of automatic insertion machines.

For detailed tape specifications refer to packaging information: www.vishay.com/doc?28139 or end of catalog

Specific Method of Mounting to Withstand Vibration and Shock

In order to withstand vibration and shock tests, it must be ensured that capacitor body is in good contact with the printed-circuit board:

- For $L \leq 19$ mm capacitors shall be mechanically fixed by the leads
- For larger pitches the capacitors shall be mounted in the same way and the body clamped
- The maximum diameter and length of the capacitors are specified in the dimensions table
- Eccentricity as shown in the drawing below:

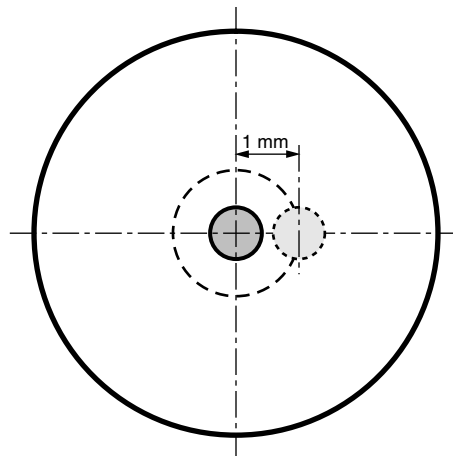

SOLDERING CONDITIONS

For general soldering conditions and wave soldering profile, we refer to the application note:

“Soldering Guidelines for Film Capacitors”: www.vishay.com/doc?28171

Storage Temperature

- $T_{stg} = -25$ °C to $+35$ °C with RH maximum 75 % without condensation.

Ratings and Characteristics Reference Conditions

Unless otherwise specified, all electrical values apply to an ambient temperature of 23 °C ± 1 °C, an atmospheric pressure of 86 kPa to 106 kPa and a relative humidity of 50 % ± 2 %.

For reference testing, a conditioning period shall be applied over 96 h ± 4 h by heating the products in a circulating air oven at the rated temperature and a relative humidity not exceeding 20 %.

CHARACTERISTICS

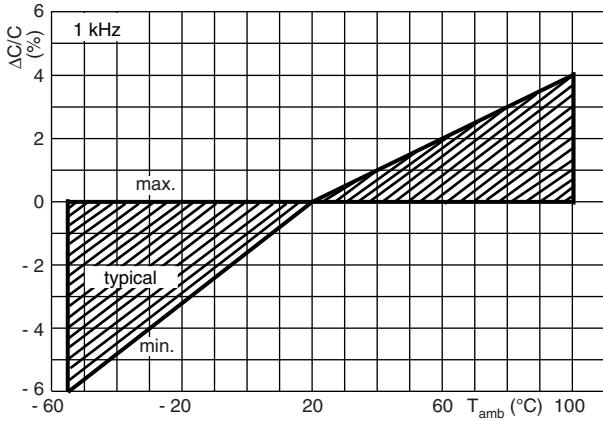

Capacitance as a function of ambient temperature (typical curve)

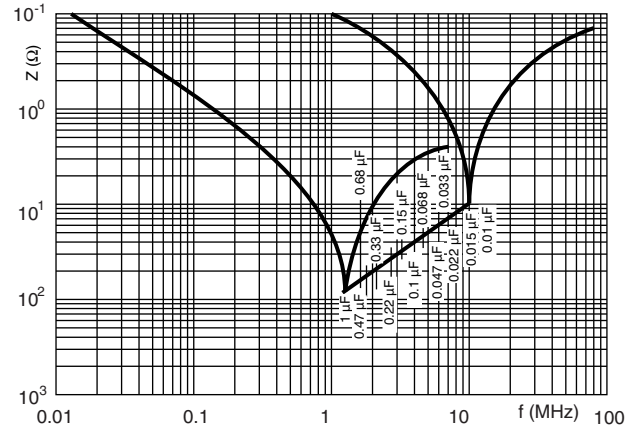

Impedance (Z) as a function of frequency (f)
at $T_a = 20\text{ °C}$ (average)
Measurement with length 6 mm

Impedance as a function of frequency (typical curve)

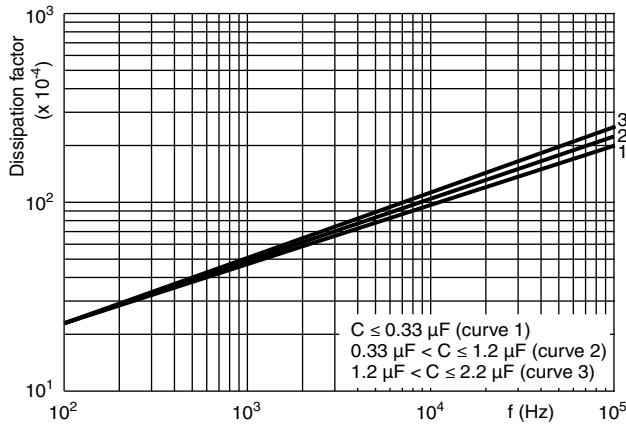

Tangent of loss angle as a function of frequency (typical curve)

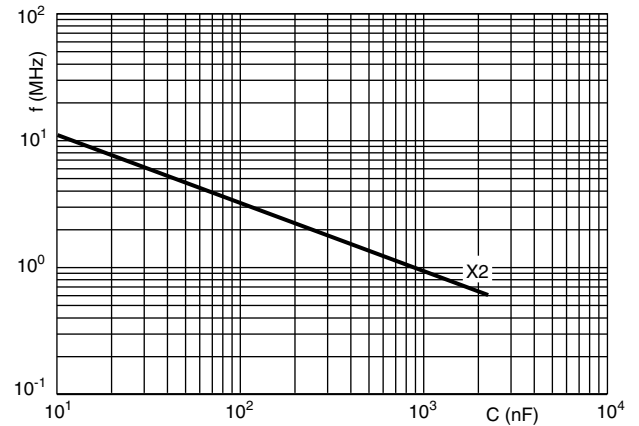

Resonant frequency as a function of capacitance (typical curve)

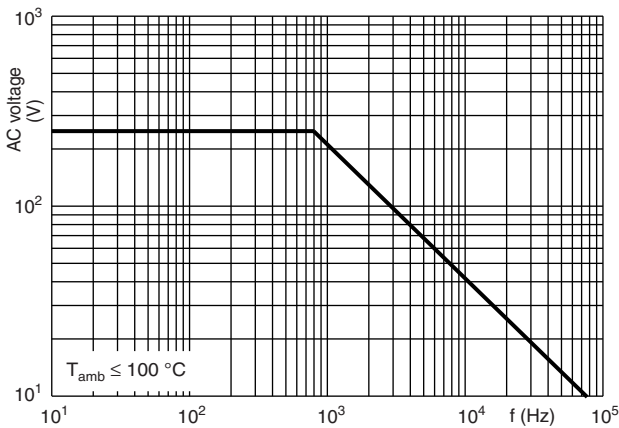

Max. RMS voltage as a function of frequency

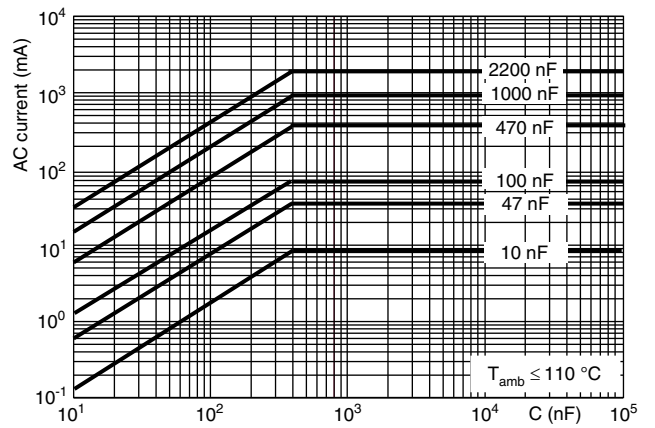

Max. RMS current as a function of frequency

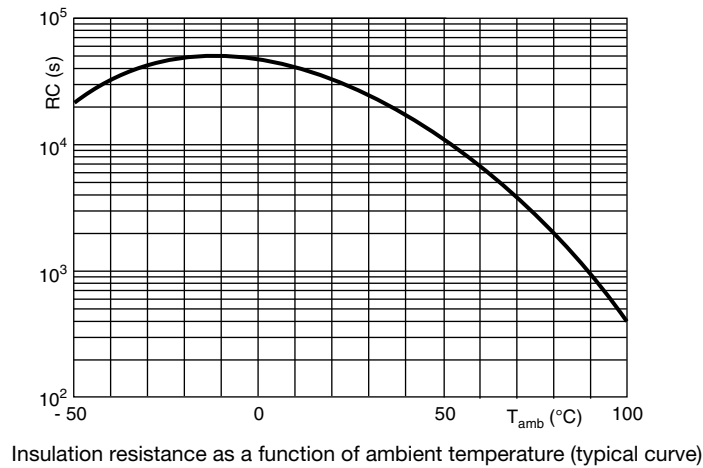

APPLICATION NOTES AND LIMITING CONDITIONS

- For X2 electromagnetic interference suppression where a higher stability grade is needed for **continuous across the line applications** (50 Hz / 60 Hz) with a maximum mains voltage of 253 V_{AC}.
- These capacitors are not intended for continuous pulse application. For these situations capacitors of the AC and pulse programs must be used.
- For series impedance applications we refer to application note: www.vishay.com/doc?28153
- The maximum ambient temperature must not exceed 100 °C.
- Rated voltage pulse slope:
if the pulse voltage is lower than the rated voltage, the values of the specific reference data can be multiplied by 350 V_{DC} and divided by the applied voltage.

INSPECTION REQUIREMENTS

General Notes

Sub-clause numbers of tests and performance requirements refer to the “Sectional Specification, Publication IEC 60384-14 ed-4 (2013) and Specific Reference Data”.

GROUP C INSPECTION REQUIREMENTS		
SUB-CLAUSE NUMBER AND TEST	CONDITIONS	PERFORMANCE REQUIREMENTS
SUB-GROUP C1A PART OF SAMPLE OF SUB-GROUP C1		
4.1 Dimensions (detail)		As specified in chapters “General Data” of this specification
Initial measurements	Capacitance Tangent of loss angle: for C ≤ 1 μF at 10 kHz or for C > 1 μF at 1 kHz	
4.3 Robustness of terminations	Tensile: load 10 N; 10 s Bending: load 5 N; 4 x 90°	No visible damage
4.4 Resistance to soldering heat	No pre-drying Method: 1A Solder bath: 280 °C ± 5 °C Duration: 10 s	



GROUP C INSPECTION REQUIREMENTS		
SUB-CLAUSE NUMBER AND TEST	CONDITIONS	PERFORMANCE REQUIREMENTS
SUB-GROUP C1A PART OF SAMPLE OF SUB-GROUP C1		
4.19 Component solvent resistance	Isopropylalcohol at room temperature Method: 2 Immersion time: 5 min ± 0.5 min Recovery time: min. 1 h, max. 2 h	
4.4.2 Final measurements	Visual examination Capacitance Tangent of loss angle Insulation resistance	No visible damage Legible marking $ \Delta C/C \leq 5\%$ of the value measured initially Increase of $\tan \delta$: ≤ 0.008 for: $C \leq 1 \mu F$ or ≤ 0.005 for: $C > 1 \mu F$ Compared to values measured initially As specified in section "Insulation Resistance" of this specification
SUB-GROUP C1B PART OF SAMPLE OF SUB-GROUP C1		
Initial measurements	Capacitance Tangent of loss angle: for $C \leq 1 \mu F$ at 10 kHz or for $C > 1 \mu F$ at 1 kHz	
4.20 Solvent resistance of the marking	Isopropylalcohol at room temperature Method: 1 Rubbing material: cotton wool Immersion time: 5 min ± 0.5 min	No visible damage Legible marking
4.6 Rapid change of temperature	$\theta A = -40\text{ }^\circ C$ $\theta B = +100\text{ }^\circ C$ 5 cycles Duration $t = 30$ min	
4.6.1 Inspection	Visual examination	No visible damage
4.7 Vibration	Mounting: see section "Mounting" of this specification Procedure B4 Frequency range: 10 Hz to 55 Hz Amplitude: 0.75 mm or Acceleration 98 m/s ² (whichever is less severe) Total duration 6 h	
4.7.2 Final inspection	Visual examination	No visible damage
4.9 Shock	Mounting: see section "Mounting" for more information Pulse shape: half sine Acceleration: 490 m/s ² Duration of pulse: 11 ms	
4.9.2 Final measurements	Visual examination Capacitance Tangent of loss angle Insulation resistance	No visible damage $ \Delta C/C \leq 5\%$ of the value measured initially Increase of $\tan \delta$: ≤ 0.008 for: $C \leq 1 \mu F$ or ≤ 0.005 for: $C > 1 \mu F$ Compared to values measured initially As specified in section "Insulation Resistance" of this specification



GROUP C INSPECTION REQUIREMENTS		
SUB-CLAUSE NUMBER AND TEST	CONDITIONS	PERFORMANCE REQUIREMENTS
SUB-GROUP C1 COMBINED SAMPLE OF SPECIMENS OF SUB-GROUPS C1A AND C1B		
4.11 Climatic sequence 4.11.1 Initial measurements 4.11.2 Dry heat 4.11.3 Damp heat cyclic Test Db First cycle 4.11.4 Cold 4.11.5 Damp heat cyclic Test Db remaining cycles 4.11.6 Final measurements	Capacitance: measured in 4.4.2 and 4.9.2 Tangent of loss angle: measured initially in C1A and C1B Temperature: 100 °C Duration: 16 h Temperature: -40 °C Duration: 2 h Visual examination Capacitance Tangent of loss angle Voltage proof 1200 V _{DC} ; 1 min between terminations Insulation resistance	No visible damage Legible marking $ \Delta C/C \leq 5\%$ of the value measured in 4.11.1. Increase of tan δ : ≤ 0.008 for: $C \leq 1 \mu\text{F}$ or ≤ 0.005 for: $C > 1 \mu\text{F}$ Compared to values measured in 4.11.1. No permanent breakdown or flash-over $\geq 50\%$ of values specified in section "Insulation Resistance" of this specification
SUB-GROUP C2		
4.12 Damp heat steady state 4.12.1 Initial measurements 4.12.3 Final measurements	21 days; 40 °C; 90 % to 95 % RH no load Capacitance Tangent of loss angle: for $C \leq 1 \mu\text{F}$ at 10 kHz or for $C > 1 \mu\text{F}$ at 1 kHz Visual examination Capacitance Tangent of loss angle Voltage proof 1200 V _{DC} ; 1 min between terminations Insulation resistance	No visible damage Legible marking $ \Delta C/C \leq 5\%$ of the value measured in 4.12.1. Increase of tan δ : ≤ 0.008 for: $C \leq 1 \mu\text{F}$ or ≤ 0.005 for: $C > 1 \mu\text{F}$ Compared to values measured in 4.12.1. No permanent breakdown or flash-over $\geq 50\%$ of values specified in section "Insulation Resistance" of this specification

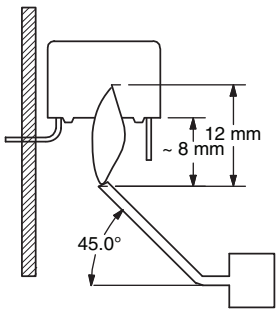

GROUP C INSPECTION REQUIREMENTS		
SUB-CLAUSE NUMBER AND TEST	CONDITIONS	PERFORMANCE REQUIREMENTS
SUB-GROUP C3		
4.13.1 Initial measurements	Capacitance Tangent of loss angle: for C ≤ 1 μF at 10 kHz or for C > 1 μF at 1 kHz	
4.13 Impulse voltage	3 successive impulses, full wave, peak voltage: X2: 2.5 kV for C ≤ 1 μF X2: 2.5 kV/√C for C > 1 μF Max. 24 pulses	No self healing breakdowns or flash-over
4.14 Endurance	Duration: 1000 h 1.25 x U _{RAC} at 100 °C for C ≤ 1 μF 1.25 x U _{RAC} at 85 °C for C > 1 μF Once in every hour the voltage is increased to 1000 V _{RMS} for 0.1 s via resistor of 47 Ω ± 5 %	
4.14.7 Final measurements	Visual examination	No visible damage Legible marking
	Capacitance	ΔC/C ≤ 10 % compared to values measured in 4.13.1.
	Tangent of loss angle	Increase of tan δ: ≤ 0.008 for: C ≤ 1 μF or ≤ 0.005 for: C > 1 μF Compared to values measured in 4.13.1.
	Voltage proof 1200 V _{DC} ; 1 min between terminations 2000 V _{AC} ; 1 min between terminations and case	No permanent breakdown or flash-over
	Insulation resistance	≥ 50 % of values specified in section "Insulation Resistance" of this specification
SUB-GROUP C4		
4.15 Charge and discharge	10 000 cycles Charged to 350 V _{DC} Discharge resistance: $R = \frac{350 V_{DC}}{2 \times C (dU/dt)}$	
4.15.1 Initial measurements	Capacitance Tangent of loss angle: for C ≤ 1 μF at 10 kHz or for C > 1 μF at 1 kHz	
4.15.3 Final measurements	Capacitance	ΔC/C ≤ 10 % compared to values measured in 4.15.1.
	Tangent of loss angle	Increase of tan δ: ≤ 0.008 for: C ≤ 1 μF or ≤ 0.005 for: C > 1 μF Compared to values measured in 4.15.1.
	Insulation resistance	≥ 50 % of values specified in section "Insulation Resistance" of this specification

GROUP C INSPECTION REQUIREMENTS		
SUB-CLAUSE NUMBER AND TEST	CONDITIONS	PERFORMANCE REQUIREMENTS
SUB-GROUP C5		
4.16 Radio frequency characteristic	Resonance frequency	≥ 0.9 times the value as specified in section "Resonant Frequency" of this specification
SUB-GROUP C6		
4.17 Passive flammability Class C	Bore of gas jet: $\varnothing 0.5$ mm Fuel: butane Test duration for actual volume V in mm^3 : $V \leq 250$: 5 s $250 < V \leq 500$: 10 s $500 < V \leq 1750$: 20 s $V > 1750$: 30 s One flame application	After removing test flame from capacitor, the capacitor must not continue to burn for more than 30 s. No burning particle must drop from the sample.
		
SUB-GROUP C7		
4.18 Active flammability	20 cycles of 2.5 kV discharges on the test capacitor connected to U_{RAC}	The cheese cloth around the capacitors shall not burn with a flame. No electrical measurements are required.



Disclaimer

ALL PRODUCT, PRODUCT SPECIFICATIONS AND DATA ARE SUBJECT TO CHANGE WITHOUT NOTICE TO IMPROVE RELIABILITY, FUNCTION OR DESIGN OR OTHERWISE.

Vishay Intertechnology, Inc., its affiliates, agents, and employees, and all persons acting on its or their behalf (collectively, "Vishay"), disclaim any and all liability for any errors, inaccuracies or incompleteness contained in any datasheet or in any other disclosure relating to any product.

Vishay makes no warranty, representation or guarantee regarding the suitability of the products for any particular purpose or the continuing production of any product. To the maximum extent permitted by applicable law, Vishay disclaims (i) any and all liability arising out of the application or use of any product, (ii) any and all liability, including without limitation special, consequential or incidental damages, and (iii) any and all implied warranties, including warranties of fitness for particular purpose, non-infringement and merchantability.

Statements regarding the suitability of products for certain types of applications are based on Vishay's knowledge of typical requirements that are often placed on Vishay products in generic applications. Such statements are not binding statements about the suitability of products for a particular application. It is the customer's responsibility to validate that a particular product with the properties described in the product specification is suitable for use in a particular application. Parameters provided in datasheets and / or specifications may vary in different applications and performance may vary over time. All operating parameters, including typical parameters, must be validated for each customer application by the customer's technical experts. Product specifications do not expand or otherwise modify Vishay's terms and conditions of purchase, including but not limited to the warranty expressed therein.

Except as expressly indicated in writing, Vishay products are not designed for use in medical, life-saving, or life-sustaining applications or for any other application in which the failure of the Vishay product could result in personal injury or death. Customers using or selling Vishay products not expressly indicated for use in such applications do so at their own risk. Please contact authorized Vishay personnel to obtain written terms and conditions regarding products designed for such applications.

No license, express or implied, by estoppel or otherwise, to any intellectual property rights is granted by this document or by any conduct of Vishay. Product names and markings noted herein may be trademarks of their respective owners.