

Isolated Glass Passivated Super Fast Rectifiers

FEATURES

- High efficiency, low VF.
- High current capability
- High reliability
- High surge current capability
- Low power loss.
- UL Recognized File # E-326243
- Compliant to RoHS Directive 2011/65/EU and in accordance to WEEE 2002/96/EC
- Halogen-free according to IEC 61249-2-21 definition

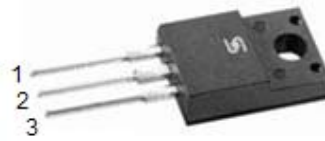

ITO-220AB

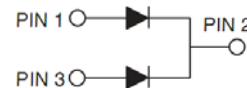

MECHANICAL DATA

Case: ITO-220AB

Molding compound, UL flammability classification rating 94V-0

Base P/N with suffix "G" on packing code - (green compound) halogen-free

Base P/N with prefix "H" on packing code - AEC-Q101 qualified

Terminal: Matte tin plated leads, solderable per JESD22-B102

Meet JESD 201 class 1A whisker test,

with prefix "H" on packing code meet JESD 201 class 2 whisker test

Polarity: As marked

Mounting torque: 5 in-lbs maximum

Weight: 1.7 g (approximately)

MAXIMUM RATINGS AND ELECTRICAL CHARACTERISTICS (T _A =25°C unless otherwise noted)										
PARAMETER	SYMBOL	SFF	SFF	SFF	SFF	SFF	SFF	SFF	SFF	UNIT
		1001G	1002G	1003G	1004G	1005G	1006G	1007G	1008G	
Maximum repetitive peak reverse voltage	V _{RRM}	50	100	150	200	300	400	500	600	V
Maximum RMS voltage	V _{RMS}	35	70	105	140	210	280	350	420	V
Maximum DC blocking voltage	V _{DC}	50	100	150	200	300	400	500	600	V
Maximum average forward rectified current	I _{F(AV)}	10								A
Peak forward surge current, 8.3 ms single half sine-wave superimposed on rated load	I _{FSM}	125								A
Maximum instantaneous forward voltage (Note 1) I _F = 5A	V _F	0.975			1.3		1.7			V
Maximum reverse current @ Rated V _R T _J =25 °C T _J =125 °C	I _R	10				400				μA
Maximum reverse recovery time (Note 2)	T _{rr}	35								ns
Typical junction capacitance (Note 3)	C _j	70				50				pF
Typical thermal resistance	R _{θJC}	2								°C/W
Operating junction temperature range	T _J	- 55 to +150								°C
Storage temperature range	T _{STG}	- 55 to +150								°C

Note 1: Pulse Test with PW=300μs, 1% Duty Cycle

Note 2: Reverse Recovery Test Conditions: I_F=0.5A, I_R=1.0A, I_{RR}=0.25A.

Note 3: Measured at 1 MHz and Applied Reverse Voltage of 4.0V D.C.

ORDERING INFORMATION					
PART NO.	AEC-Q101 QUALIFIED	PACKING CODE	GREEN COMPOUND CODE	PACKAGE	PACKING
SFF100xG (Note 1)	Prefix "H"	C0	Suffix "G"	ITO-220AB	50 / Tube

Note 1: "x" defines voltage from 50V (SFF1001G) to 600V (SFF1008G)

EXAMPLE					
PREFERRED P/N	PART NO.	AEC-Q101 QUALIFIED	PACKING CODE	GREEN COMPOUND CODE	DESCRIPTION
SFF1008G C0	SFF1008G		C0		
SFF1008G C0G	SFF1008G		C0	G	Green compound
SFF1008GHC0	SFF1008G	H	C0		AEC-Q101 qualified

RATINGS AND CHARACTERISTICS CURVES

(TA=25°C unless otherwise noted)

FIG.1 FORWARD CURRENT DERATING CURVE

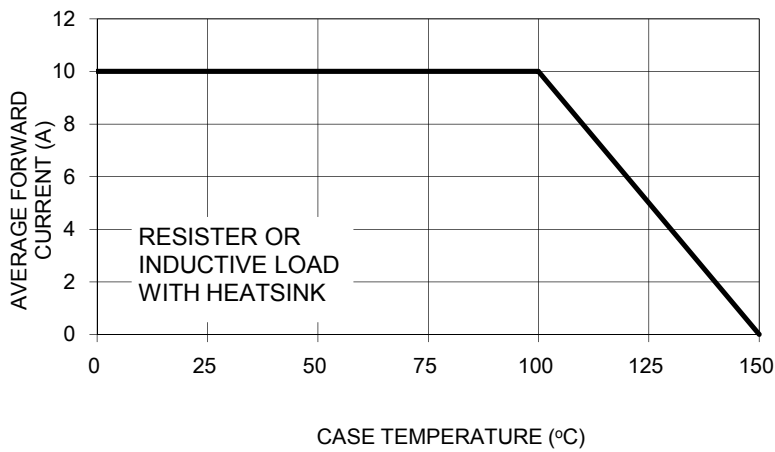

FIG. 2 TYPICAL REVERSE CHARACTERISTICS

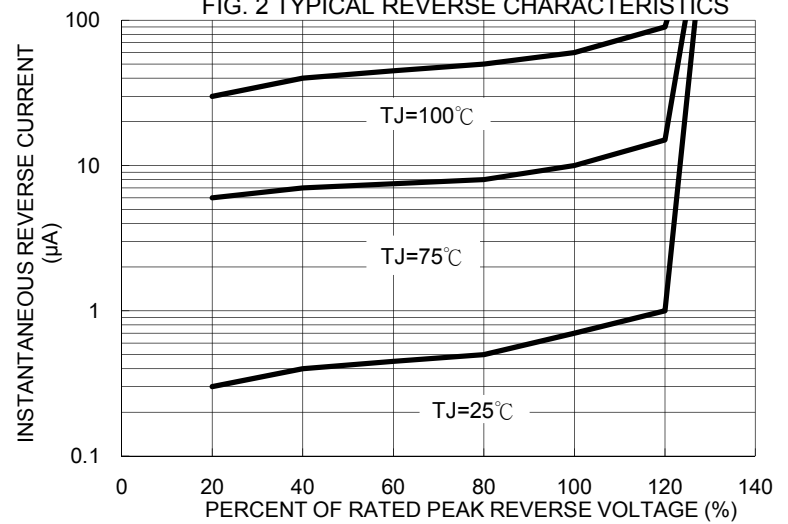

FIG. 3 MAXIMUM NON-REPETITIVE FORWARD SURGE CURRENT

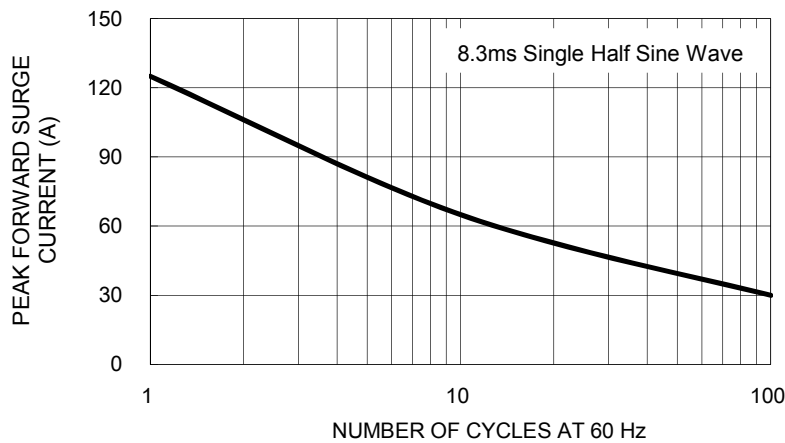

FIG. 4 TYPICAL FORWARD CHARACTERISTICS

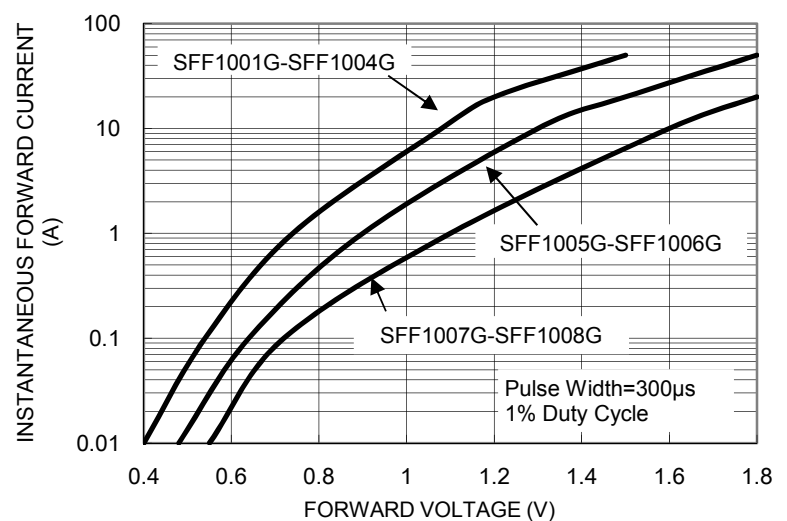

FIG. 5 TYPICAL JUNCTION CAPACITANCE

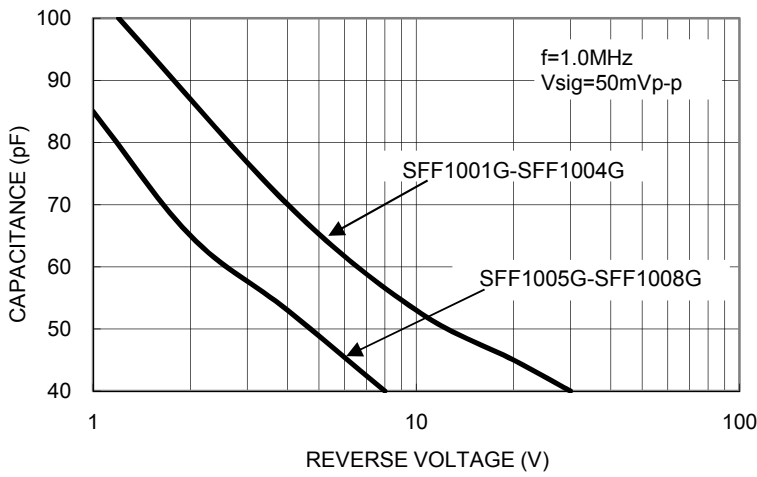
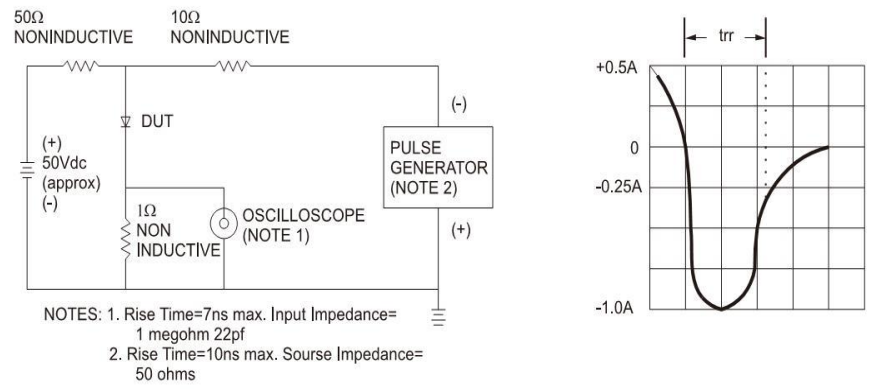
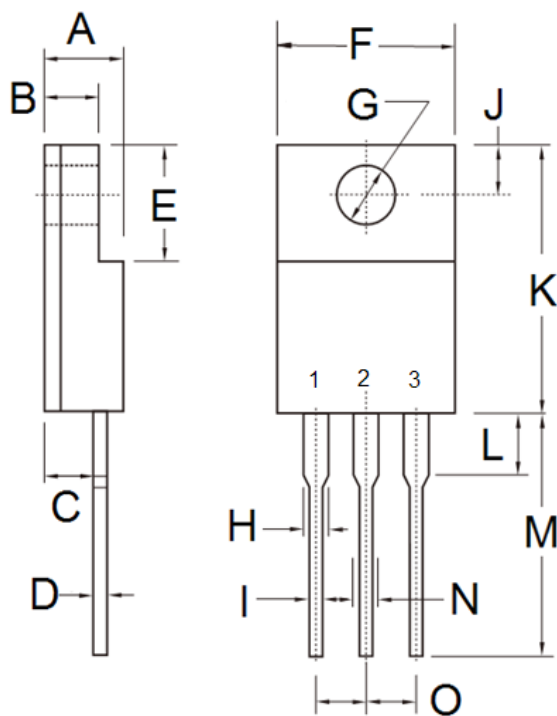

FIG.6- REVERSE RECOVERY TIME CHARACTERISTIC AND TEST CIRCUIT DIAGRAM



PACKAGE OUTLINE DIMENSIONS



DIM.	Unit (mm)		Unit (inch)	
	Min	Max	Min	Max
A	4.30	4.70	0.169	0.185
B	2.50	3.16	0.098	0.124
C	2.30	2.96	0.091	0.117
D	0.46	0.76	0.018	0.030
E	6.30	6.90	0.248	0.272
F	9.60	10.30	0.378	0.406
G	3.00	3.40	0.118	0.134
H	0.95	1.45	0.037	0.057
I	0.50	0.90	0.020	0.035
J	2.40	3.20	0.094	0.126
K	14.80	15.50	0.583	0.610
L	-	4.10	-	0.161
M	12.60	13.80	0.496	0.543
N	-	1.80	-	0.071
O	2.41	2.67	0.095	0.105

MARKING DIAGRAM

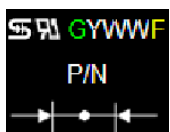

- P/N = Specific Device Code
- G = Green Compound
- YWW = Date Code
- F = Factory Code

Notice

Specifications of the products displayed herein are subject to change without notice. TSC or anyone on its behalf, assumes no responsibility or liability for any errors inaccuracies.

Information contained herein is intended to provide a product description only. No license, express or implied, to any intellectual property rights is granted by this document. Except as provided in TSC's terms and conditions of sale for such products, TSC assumes no liability whatsoever, and disclaims any express or implied warranty, relating to sale and/or use of TSC products including liability or warranties relating to fitness for a particular purpose, merchantability, or infringement of any patent, copyright, or other intellectual property right.

The products shown herein are not designed for use in medical, life-saving, or life-sustaining applications. Customers using or selling these products for use in such applications do so at their own risk and agree to fully indemnify TSC for any damages resulting from such improper use or sale.

Mouser Electronics

Authorized Distributor

Click to View Pricing, Inventory, Delivery & Lifecycle Information:

Taiwan Semiconductor:

[SFF1001G](#) [SFF1002G](#) [SFF1003G](#) [SFF1004G](#) [SFF1005G](#) [SFF1006G](#) [SFF1007G](#) [SFF1008G](#) [SFF1004G C0](#)
[SFF1001G C0](#) [SFF1006G C0](#) [SFF1007G C0](#) [SFF1002G C0](#) [SFF1003G C0](#) [SFF1008G C0](#) [SFF1005G C0G](#)