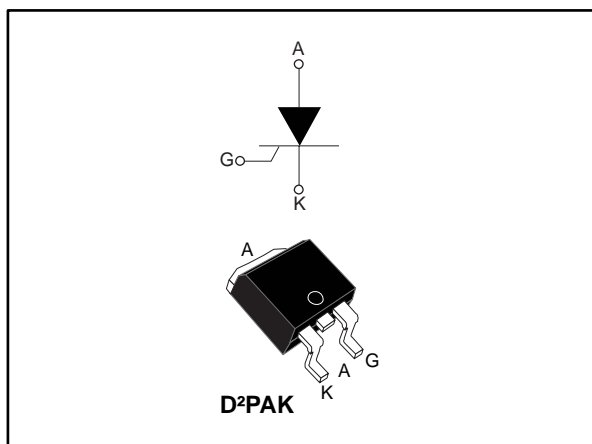

## High temperature 16 A SCRs

Datasheet - production data

**Description**

Designed with high immunity switching to external surges, this device offers robust switching up to its 150°C maximum  $T_j$ .

The combination of noise immunity and low gate triggering current allows to design strong and compact control circuit.

**Table 1: Device summary**

Order code	Package	$V_{DRM}/V_{RRM}$	$I_{GT}$
TN1605H-6G	D <sup>2</sup> PAK	600	6 mA

**Features**

- High junction temperature:  $T_j = 150\text{ °C}$
- Gate triggering current  $I_{GT} = 6\text{ mA}$
- High noise immunity  $dV/dt = 200\text{ V}/\mu\text{s}$  up to 150 °C
- Blocking voltage  $V_{DRM}/V_{RRM} = 600\text{ V}$
- High turn-on current rise  $dI/dt: 100\text{ A}/\mu\text{s}$
- ECOPACK<sup>®</sup>2 compliant component

**Applications**

- Motorbikes voltage regulator circuits
- Inrush current limiting circuits
- Motor control circuits and starters
- Light dimmers
- Solid state relays

# 1 Characteristics

**Table 2: Absolute maximum ratings (limiting values,  $T_j = 25\text{ °C}$  unless otherwise specified)**

Symbol	Parameter		Value	Unit	
$I_{T(RMS)}$	RMS on-state current (180° conduction angle)		$T_c = 133\text{ °C}$	16	A
$I_{T(AV)}$	Average on-state current (180° conduction angle)		$T_c = 133\text{ °C}$	10	A
			$T_c = 138\text{ °C}$	8	
			$T_c = 142\text{ °C}$	6	
$I_{TSM}$	Non repetitive surge peak on-state current	$t_p = 8.3\text{ ms}$	$T_j\text{ initial} = 25\text{ °C}$	153	A
		$t_p = 10\text{ ms}$		140	
$I^2t$	$I^2t$ value for fusing	$t_p = 10\text{ ms}$		98	$A^2s$
$di/dt$	Critical rate of rise of on-state current	$I_G = 2 \times I_{GT}$ , $t_r \leq 100\text{ ns}$ ,	$f = 60\text{ Hz}$	100	$A/\mu s$
$V_{DRM}/V_{RRM}$	Repetitive peak off-state voltage		$T_j = 150\text{ °C}$	600	V
$V_{DSM}/V_{RSM}$	Non repetitive surge peak off- state voltage	$t_p = 10\text{ ms}$		700	V
$P_G(AV)$	Average gate power dissipation		$T_j = 150\text{ °C}$	1	W
$V_{RGM}$	Maximum peak reverse gate voltage			5	V
$I_{GM}$	Peak gate current	$t_p = 20\text{ }\mu s$	$T_j = 150\text{ °C}$	4	A
$T_{stg}$	Storage junction temperature range			-40 to +150	$^{\circ}C$
$T_j$	Operating junction temperature range			-40 to +150	$^{\circ}C$

**Table 3: Dynamic characteristics**

Symbol	Parameter	$T_j$		Value	Unit
$I_{GT}$	$V_D = 12\text{ V}$ , $R_L = 33\text{ }\Omega$	25 $^{\circ}C$	Min.	3.5	mA
			Typ.	4.5	
			Max.	6	
$V_{GT}$			Max.	1.3	V
$V_{GD}$	$V_D = 600$ , $R_L = 3.3\text{ k}\Omega$	150 $^{\circ}C$	Min.	0.15	V
$I_L$	$I_G = 1.2 \times I_{GT}$	25 $^{\circ}C$	Max.	40	mA
$I_H$	$I_T = 500\text{ mA}$ , gate open		Max.	20	
$dV/dt$	$V_D = 402\text{ V}$ , gate open	150 $^{\circ}C$	Min.	200	$V/\mu s$
$t_{gt}$	$I_{TM} = 32\text{ A}$ , $V_D = 402\text{ V}$ , $I_G = 12\text{ mA}$ , $(di_G/dt)$ max = 0.2 $A/\mu s$	25 $^{\circ}C$	Typ.	1.9	$\mu s$
$t_q$	$I_{TM} = 32\text{ A}$ , $V_D = 402\text{ V}$ , $(di/dt)_{off} = 30\text{ A}/\mu s$ , $V_R = 25\text{ V}$ , $dV_D/dt = 20\text{ V}/\mu s$	150 $^{\circ}C$	Typ.	70	$\mu s$

Table 4: Static electrical characteristics

Symbol	Test conditions	$T_j$		Value	Unit
$V_{TM}$	$I_{TM} = 32 \text{ A}$ , $t_p = 380 \mu\text{s}$	25 °C	Max.	1.6	V
$V_{TO}$	Threshold on-state voltage	150 °C	Max.	0.82	V
$R_D$	Dynamic resistance	150 °C	Max.	25	m $\Omega$
$I_{DRM}/I_{RRM}$	$V_{DRM} = V_{RRM}$	25 °C	Max.	5	$\mu\text{A}$
		125 °C		1.5	mA
		150 °C		3.1	

Table 5: Thermal resistance

Symbol	Parameter			Value	Unit
$R_{th(j-c)}$	Junction to case (DC)		Max.	1.1	$^{\circ}\text{C}/\text{W}$
$R_{th(j-a)}$	Junction to ambient (DC)	$S^{(1)} = 1 \text{ cm}^2$	Typ.	45	

**Notes:**<sup>(1)</sup>S = copper surface under tab

# 1.1 Characteristics (curves)

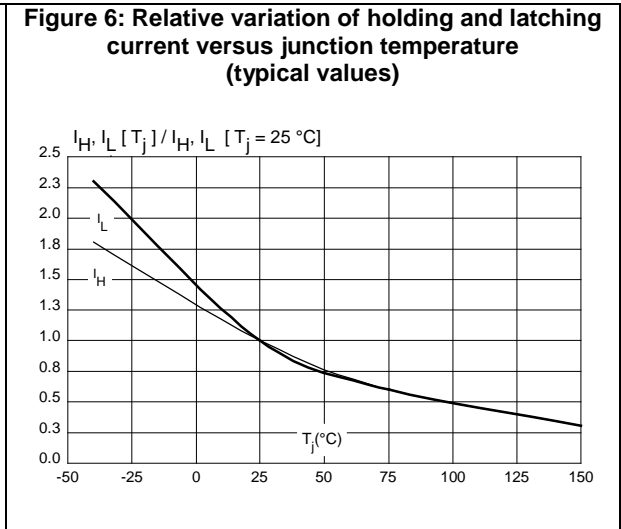
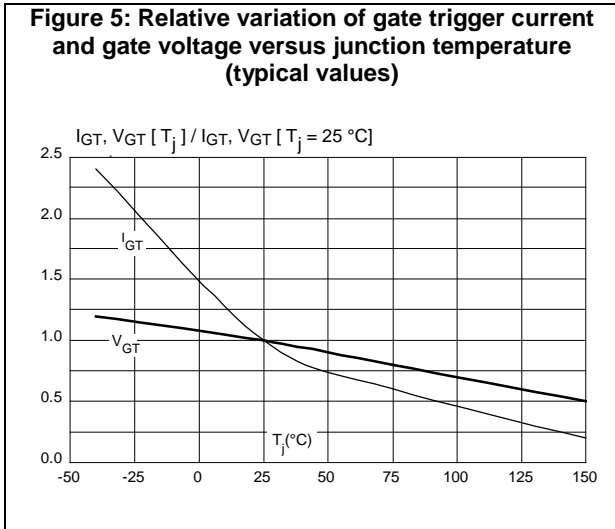
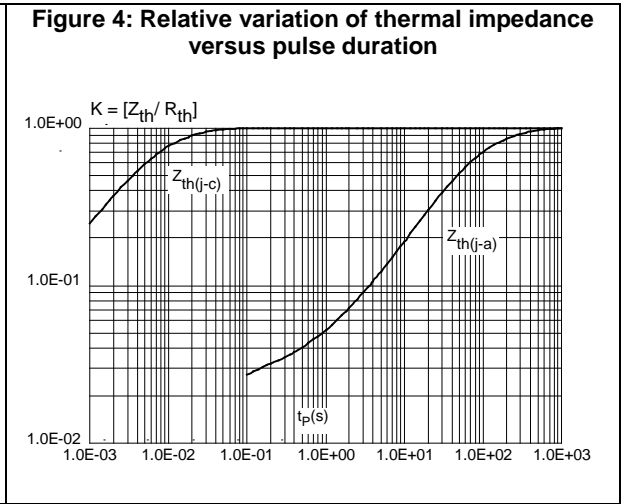
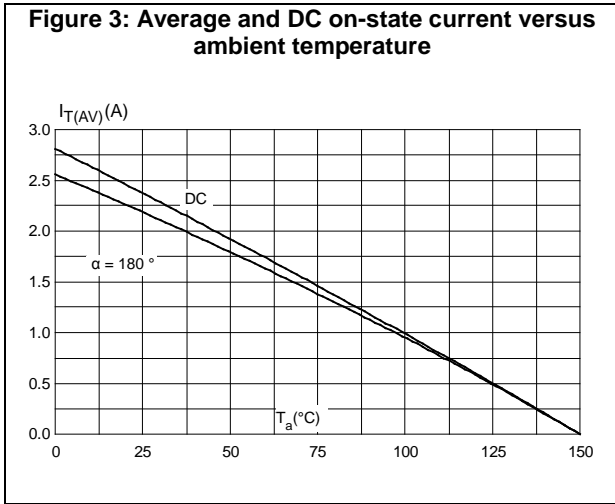
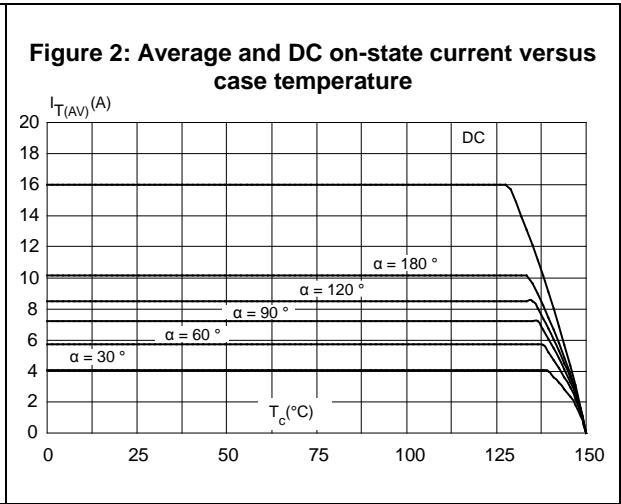
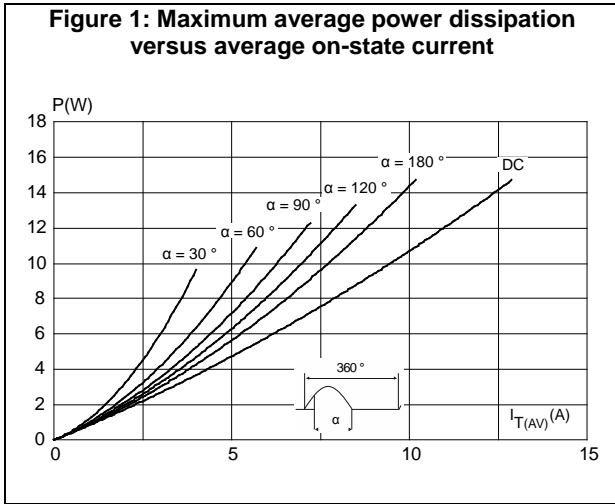

**Figure 7: Relative variation of static dV/dt immunity versus junction temperature (typical values)**

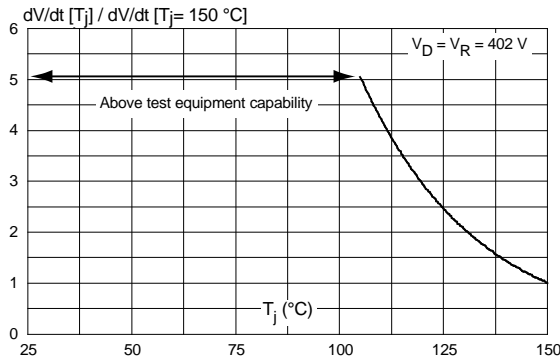

**Figure 8: Surge peak on-state current versus number of cycles**

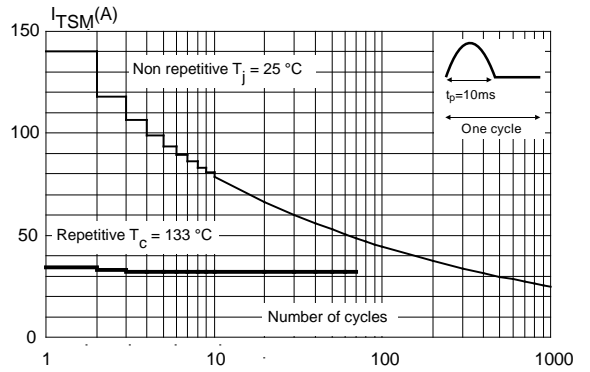

**Figure 9: Non repetitive surge peak on-state current versus sinusoidal pulse width (tp < 10 ms).**

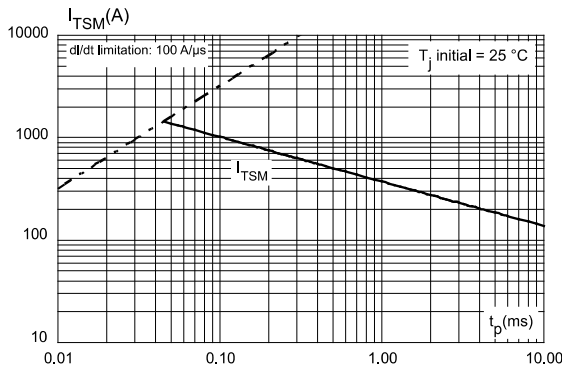

**Figure 10: On-state characteristics (maximum values)**

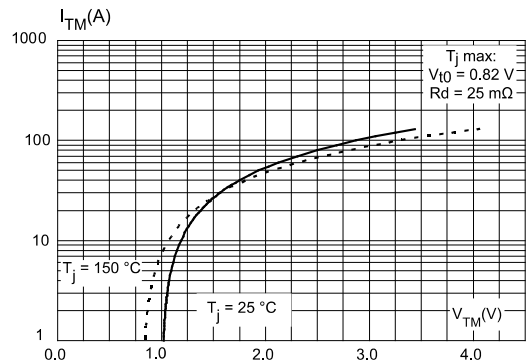

**Figure 11: Relative variation of leakage current versus junction temperature (tP < 10ms)**

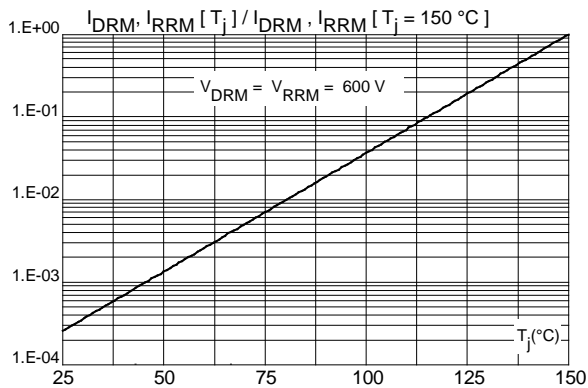

## 2 Package information

In order to meet environmental requirements, ST offers these devices in different grades of ECOPACK® packages, depending on their level of environmental compliance. ECOPACK® specifications, grade definitions and product status are available at: [www.st.com](http://www.st.com). ECOPACK® is an ST trademark.

- Epoxy meets UL 94,V0
- Lead-free package

### 2.1 D<sup>2</sup>PAK package information

Figure 12: D<sup>2</sup>PAK package outline

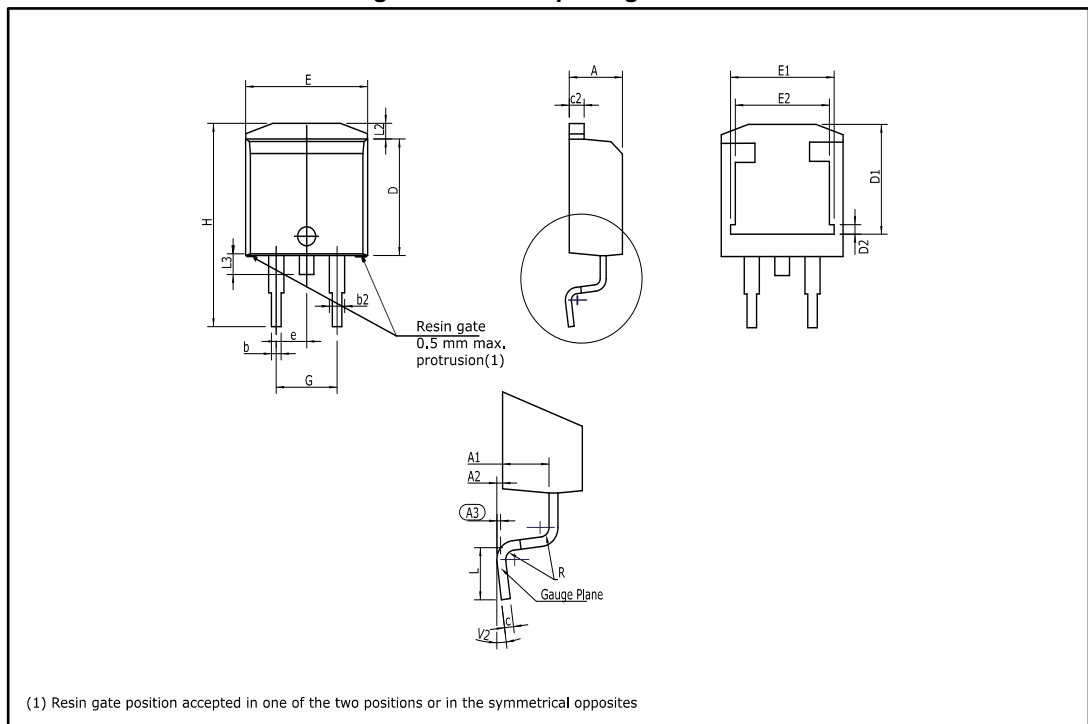
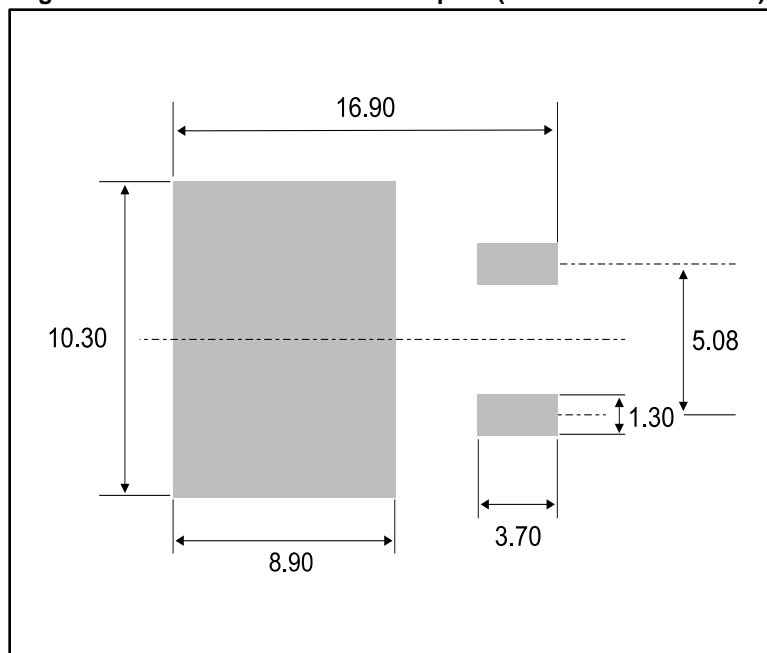

Table 6: D<sup>2</sup>PAK package mechanical data

Ref.	Dimensions					
	Millimeters			Inches <sup>(1)</sup>		
	Min.	Typ.	Max.	Min.	Typ.	Max.
A	4.30		4.60	0.1693		0.1811
A1	2.49		2.69	0.0980		0.1059
A2	0.03		0.23	0.0012		0.0091
A3		0.25			0.0098	
b	0.70		0.93	0.0276		0.0366
b2	1.25		1.7	0.0492		0.0669
c	0.45		0.60	0.0177		0.0236
c2	1.21		1.36	0.0476		0.0535
D	8.95		9.35	0.3524		0.3681
D1	7.50		8.00	0.2953		0.3150
D2	1.30		1.70	0.0512		0.0669
e	2.54			0.1		
E	10.00		10.28	0.3937		0.4047
E1	8.30		8.70	0.3268		0.3425
E2	6.85		7.25	0.2697		0.2854
G	4.88		5.28	0.1921		0.2079
H	15		15.85	0.5906		0.6240
L	1.78		2.28	0.0701		0.0898
L2	1.27		1.40	0.0500		0.0551
L3	1.40		1.75	0.0551		0.0689
R		0.40			0.0157	
V2	0°		8°	0°		8°

**Notes:**<sup>(1)</sup>Dimensions in inches are given for reference only

Figure 13: D<sup>2</sup>PAK recommended footprint (dimensions are in mm)





### 3 Ordering information

Figure 14: Ordering information scheme

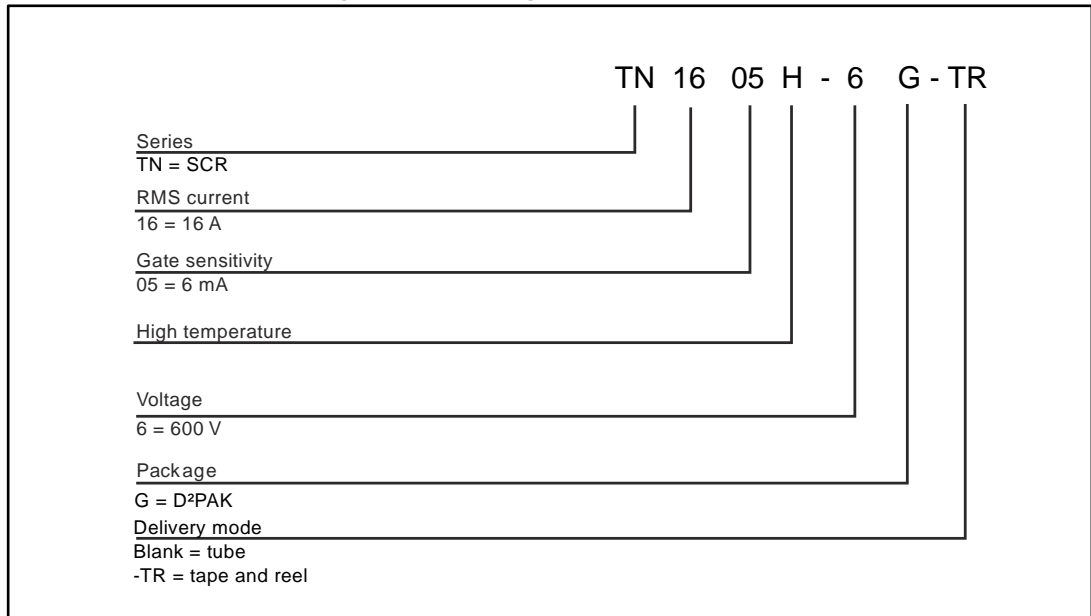

Table 7: Ordering information

Order code	Marking	Package	Weight	Base qty.	Delivery mode
TN1605H-6G	TN1605H6	D <sup>2</sup> PAK	1.5 g	50	Tube
TN1605H-6G-TR				1000	Tape and reel

### 4 Revision history

Table 8: Document revision history

Date	Revision	Changes
18-May-2017	1	Initial release.
26-Jun-2017	2	Updated <a href="#">Table 5: "Thermal resistance"</a> .

**IMPORTANT NOTICE – PLEASE READ CAREFULLY**

STMicroelectronics NV and its subsidiaries ("ST") reserve the right to make changes, corrections, enhancements, modifications, and improvements to ST products and/or to this document at any time without notice. Purchasers should obtain the latest relevant information on ST products before placing orders. ST products are sold pursuant to ST's terms and conditions of sale in place at the time of order acknowledgement.

Purchasers are solely responsible for the choice, selection, and use of ST products and ST assumes no liability for application assistance or the design of Purchasers' products.

No license, express or implied, to any intellectual property right is granted by ST herein.

Resale of ST products with provisions different from the information set forth herein shall void any warranty granted by ST for such product.

ST and the ST logo are trademarks of ST. All other product or service names are the property of their respective owners.

Information in this document supersedes and replaces information previously supplied in any prior versions of this document.

© 2017 STMicroelectronics – All rights reserved

# Mouser Electronics

Authorized Distributor

Click to View Pricing, Inventory, Delivery & Lifecycle Information:

[STMicroelectronics:](#)

[TN1605H-6G](#) [TN1605H-6G-TR](#)