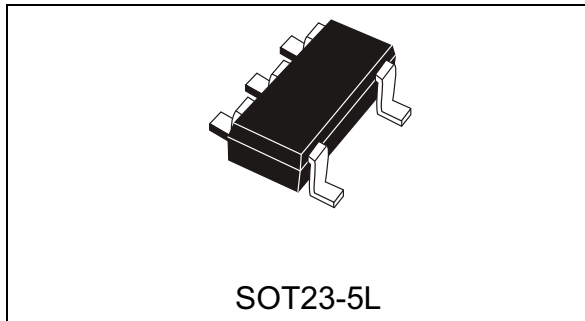


## Ultra low drop and low noise BiCMOS voltage regulators

Datasheet - production data



### Description

The LD3985 provides up to 150 mA, from 2.5 V to 6 V input voltage. The ultra low drop voltage, low quiescent current and low noise make it suitable for low power applications and in battery-powered systems. Regulator ground current increases slightly in dropout only, prolonging the battery life. Power supply rejection is better than 60 dB at low frequencies and rolls off at 10 kHz. High power supply rejection is maintained down to low input voltage levels common to battery operated circuits. Shutdown logic control function is available, this means that when the device is used as local regulator, it is possible to put a part of the board in standby, decreasing the total power consumption. The LD3985 is designed to work with low ESR ceramic capacitors. Typical applications are in mobile phones and similar battery-powered wireless systems.

### Features

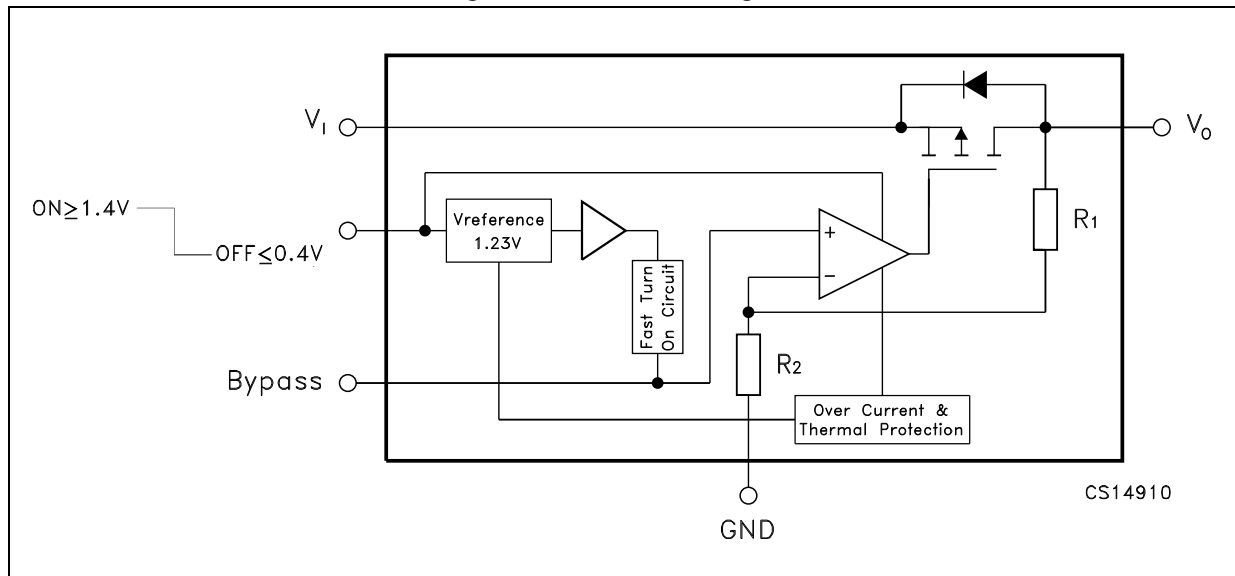
- Input voltage from 2.5 V to 6 V
- Stable with low ESR ceramic capacitors
- Ultra low-dropout voltage (60 mV typ. at 150 mA load, 0.4 mV typ. at 1 mA load)
- Very low quiescent current (85  $\mu$ A typ. at no load, 170  $\mu$ A typ. at 150 mA load; max. 1.5  $\mu$ A in OFF mode)
- Guaranteed output current up to 150 mA
- Wide range of output voltages: 1.22 V; 1.8 V; 2.5 V; 2.7 V; 2.8 V; 2.9 V; 3 V; 3.3 V; 4.7 V
- Fast turn-on time: typ. 200  $\mu$ s [ $C_O = 1 \mu$ F,  $C_{BYP} = 10$  nF and  $I_O = 1$  mA]
- Logic-controlled electronic shutdown
- Internal current and thermal limit
- Output low noise voltage 30  $\mu$ V<sub>RMS</sub> over 10 Hz to 100 kHz
- SVR of 60 dB at 1 kHz, 50 dB at 10 kHz
- Temperature range: - 40 °C to 125 °C

# Contents

|          |  |           |
|----------|--|-----------|
| <b>1</b> | <b>Diagram</b> .....                             | <b>3</b>  |
| <b>2</b> | <b>Pin configuration</b> .....                   | <b>4</b>  |
| <b>3</b> | <b>Typical application</b> .....                 | <b>5</b>  |
| <b>4</b> | <b>Maximum ratings</b> .....                     | <b>6</b>  |
| <b>5</b> | <b>Electrical characteristics</b> .....          | <b>7</b>  |
| <b>6</b> | <b>Typical performance characteristics</b> ..... | <b>9</b>  |
| <b>7</b> | <b>Package information</b> .....                 | <b>13</b> |
|          | 7.1 SOT23-5L package information .....           | 13        |
|          | 7.2 SOT23-5L packing information .....           | 15        |
| <b>8</b> | <b>Ordering information</b> .....                | <b>17</b> |
| <b>9</b> | <b>Revision history</b> .....                    | <b>18</b> |

# 1 Diagram

Figure 1. Schematic diagram



## 2 Pin configuration

Figure 2. Pin connection (top view)

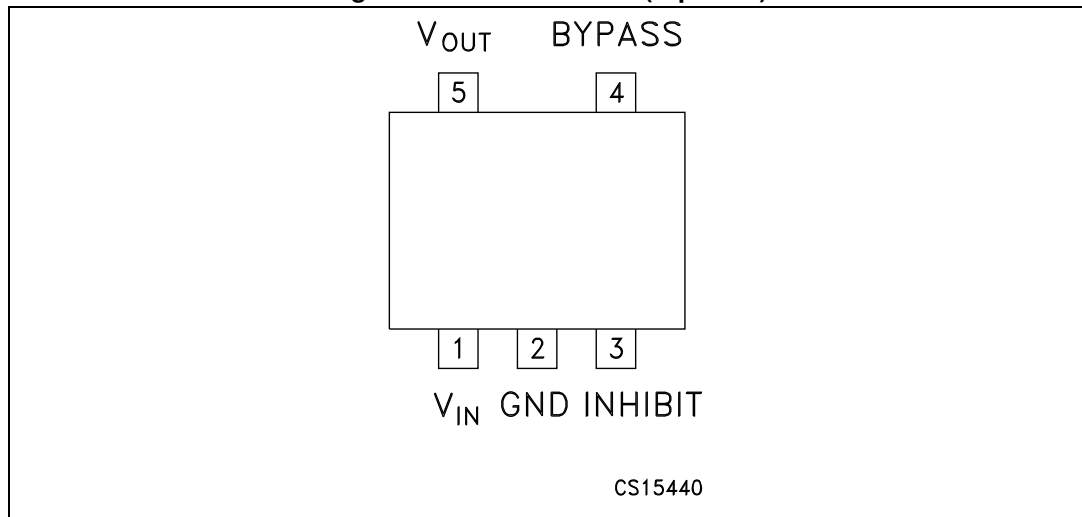
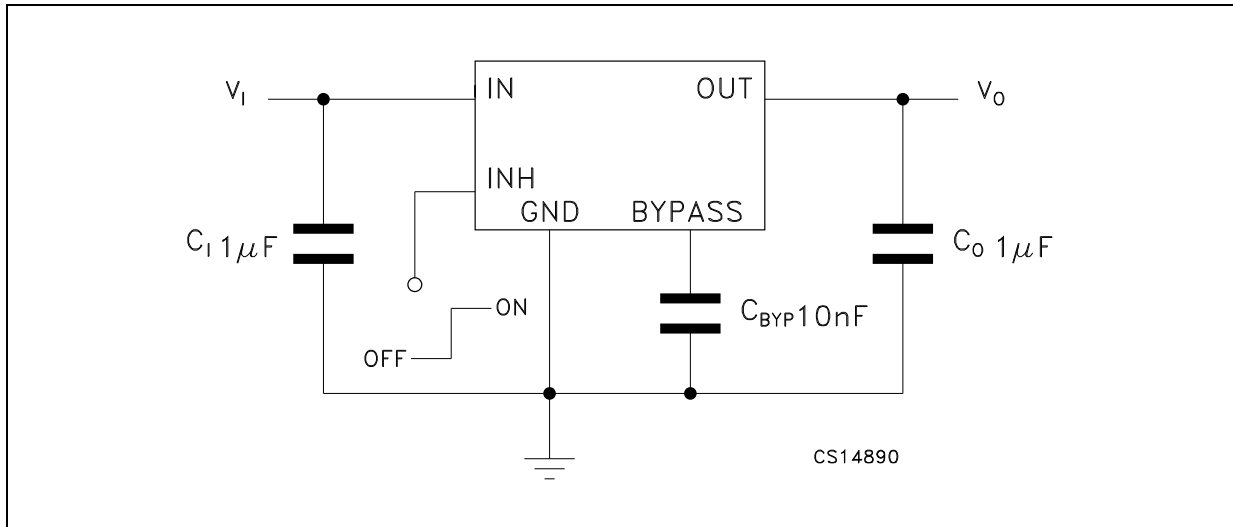


Table 1. Pin description

| Pin | Symbol    | Name and function  |
|-----|-----------|--|
| 1   | $V_I$     | Input voltage of the LDO   |
| 2   | GND       | Common ground  |
| 3   | $V_{INH}$ | Inhibit input voltage: ON mode when $V_{INH} \geq 1.2$ V, OFF mode when $V_{INH} \leq 0.4$ V (Do not leave it floating, not internally pulled down/up) |
| 4   | BYPASS    | Bypass pin: an external capacitor (usually 10 nF) has to be connected to minimize noise voltage  |
| 5   | $V_O$     | Output voltage of the LDO  |

### 3 Typical application

Figure 3. Typical application circuit



## 4 Maximum ratings

**Table 2. Absolute maximum ratings**

| Symbol    | Parameter                            | Value                    | Unit |
|-----------|--------------------------------------|--------------------------|------|
| $V_I$     | DC input voltage                     | -0.3 to 6 <sup>(1)</sup> | V    |
| $V_O$     | DC output voltage                    | -0.3 to $V_I+0.3$        | V    |
| $V_{INH}$ | Inhibit input voltage                | -0.3 to $V_I+0.3$        | V    |
| $I_O$     | Output current                       | Internally limited       |      |
| $P_D$     | Power dissipation                    | Internally limited       |      |
| $T_{STG}$ | Storage temperature range            | -65 to 150               | °C   |
| $T_{OP}$  | Operating junction temperature range | -40 to 125               | °C   |

1. The input pin is able to withstand non repetitive spike of 6.5 V for 200 ms.

*Note: Absolute maximum ratings are those values beyond which damage to the device may occur. Functional operation under these conditions is not implied.*

**Table 3. Thermal data**

| Symbol     | Parameter                           | Value | Unit |
|------------|-------------------------------------|-------|------|
| $R_{thJC}$ | Thermal resistance junction-case    | 81    | °C/W |
| $R_{thJA}$ | Thermal resistance junction-ambient | 255   | °C/W |

## 5 Electrical characteristics

$T_J = 25\text{ }^\circ\text{C}$ ,  $V_I = V_{O(NOM)} + 0.5\text{ V}$ ,  $C_I = 1\text{ }\mu\text{F}$ ,  $C_{BYP} = 10\text{ nF}$ ,  $I_O = 1\text{ mA}$ ,  $V_{INH} = 1.4\text{ V}$ , unless otherwise specified.

**Table 4. Electrical characteristics**

| Symbol       | Parameter   | Test conditions   | Min.  | Typ.   | Max.  | Unit              |
|--------------|---|---|-------|--------|-------|-------------------|
| $V_I$        | Operating input voltage                                 |   | 2.5   |        | 6     | V                 |
| $V_O$        | Output voltage accuracy, $V_{O(NOM)} < 2.5\text{ V}$    | $I_O = 1\text{ mA}$   | -50   |        | 50    | mV                |
|              |   | $T_J = -40\text{ to }125\text{ }^\circ\text{C}$   | -75   |        | 75    |                   |
| $V_O$        | Output voltage accuracy, $V_{O(NOM)} \geq 2.5\text{ V}$ | $I_O = 1\text{ mA}$   | -2    |        | 2     | % of $V_{O(NOM)}$ |
|              |   | $T_J = -40\text{ to }125\text{ }^\circ\text{C}$   | -3    |        | 3     |                   |
| $\Delta V_O$ | Line regulation <sup>(1)</sup>                          | $V_I = V_{O(NOM)} + 0.5\text{ to }6\text{ V}$<br>$T_J = -40\text{ to }125\text{ }^\circ\text{C}$                        | -0.1  |        | 0.1   | %/V               |
|              |   | $V_{O(NOM)} = 4.7\text{ to }5\text{ V}$   | -0.19 |        | 0.19  |                   |
| $\Delta V_O$ | Load regulation   | $I_O = 1\text{ mA to }150\text{ mA}$ , $V_{O(NOM)} < 2.5\text{ V}$<br>$T_J = -40\text{ to }125\text{ }^\circ\text{C}$   |       | 0.002  | 0.008 | %/mA              |
| $\Delta V_O$ | Load regulation   | $I_O = 1\text{ mA to }150\text{ mA}$ , $V_{O(NOM)} \geq 2.5\text{ V}$   |       | 0.0004 | 0.002 | %/mA              |
|              |   | $I_O = 1\text{ mA to }150\text{ mA}$ , $T_J = -40\text{ to }125\text{ }^\circ\text{C}$ , $V_{O(NOM)} \geq 2.5\text{ V}$ |       | 0.0025 | 0.005 |                   |
| $\Delta V_O$ | Output AC line regulation <sup>(2)</sup>                | $V_I = V_{O(NOM)} + 1\text{ V}$ ,<br>$I_O = 150\text{ mA}$ ,<br>$t_R = t_F = 30\text{ }\mu\text{s}$                     |       | 1.5    |       | mV <sub>PP</sub>  |
| $I_Q$        | Quiescent current<br>ON mode: $V_{INH} = 1.2\text{ V}$  | $I_O = 0$   |       | 85     |       | $\mu\text{A}$     |
|              |   | $I_O = 0$ , $T_J = -40\text{ to }125\text{ }^\circ\text{C}$   |       |        | 150   |                   |
|              |   | $I_O = 0\text{ to }150\text{ mA}$   |       | 170    |       |                   |
|              |   | $I_O = 0\text{ to }150\text{ mA}$ ,<br>$T_J = -40\text{ to }125\text{ }^\circ\text{C}$                                  |       |        | 250   |                   |
|              | OFF mode:<br>$V_{INH} = 0.4\text{ V}$                   |   |       | 0.003  |       |                   |
|              |   | $T_J = -40\text{ to }125\text{ }^\circ\text{C}$   |       |        | 1.5   |                   |

Table 4. Electrical characteristics (continued)

| Symbol             | Parameter                      | Test conditions   | Min.             | Typ. | Max. | Unit              |
|--------------------|--------------------------------|---|------------------|------|------|-------------------|
| V <sub>DROP</sub>  | Dropout voltage <sup>(3)</sup> | I <sub>O</sub> = 1 mA   |                  | 0.4  |      | mV                |
|                    |                                | I <sub>O</sub> = 1 mA,<br>T <sub>J</sub> = -40 to 125 °C  |                  |      | 2    |                   |
|                    |                                | I <sub>O</sub> = 50 mA  |                  | 20   |      |                   |
|                    |                                | I <sub>O</sub> = 50 mA,<br>T <sub>J</sub> = -40 to 125 °C   |                  |      | 35   |                   |
|                    |                                | I <sub>O</sub> = 100 mA   |                  | 45   |      |                   |
|                    |                                | I <sub>O</sub> = 100 mA,<br>T <sub>J</sub> = -40 to 125 °C  |                  |      | 70   |                   |
|                    |                                | I <sub>O</sub> = 150 mA<br>T <sub>J</sub> = -40 to 125 °C   |                  | 60   |      |                   |
| I <sub>SC</sub>    | Short-circuit current          | R <sub>L</sub> = 0  |                  | 600  |      | mA                |
| SVR                | Supply voltage rejection       | V <sub>I</sub> =<br>V <sub>O(NOM)</sub> +0.2<br>5 V ±   | f = 1<br>kHz     | 60   |      | dB                |
|                    |                                | V <sub>RIPPLE</sub> = 0.1<br>V, I <sub>O</sub> = 50 mA<br>V <sub>O(NOM)</sub> < 2.5<br>V, V <sub>I</sub> = 2.55 V | f =<br>10<br>kHz | 50   |      |                   |
| I <sub>O(PK)</sub> | Peak output current            | V <sub>O</sub> ≥ V <sub>O(NOM)</sub> - 5%   | 300              | 550  |      | mA                |
| V <sub>INH</sub>   | Inhibit input logic low        | V <sub>I</sub> = 2.5 V to 6 V,<br>T <sub>J</sub> = -40 to 125 °C  |                  |      | 0.4  | V                 |
|                    | Inhibit input logic high       |   | 1.2              |      |      |                   |
| I <sub>INH</sub>   | Inhibit input current          | V <sub>INH</sub> = 0.4 V,<br>V <sub>I</sub> = 6 V   |                  | ±1   |      | nA                |
| eN                 | Output noise voltage           | B <sub>W</sub> = 10 Hz to 100<br>kHz, C <sub>O</sub> = 1 μF   |                  | 30   |      | μV <sub>RMS</sub> |
| t <sub>ON</sub>    | Turn-on time <sup>(4)</sup>    | C <sub>BYP</sub> = 10 nF  |                  | 100  | 250  | μs                |
| T <sub>SHDN</sub>  | Thermal shutdown               | <sup>(5)</sup>  |                  | 160  |      | °C                |
| C <sub>O</sub>     | Output capacitor               | Capacitance <sup>(6)</sup>  | 1                |      | 22   | μF                |
|                    |                                | ESR   | 5                |      | 5000 | mΩ                |

1. For V<sub>O(NOM)</sub> < 2 V, V<sub>I</sub> = 2.5 V

2. For V<sub>O(NOM)</sub> = 1.25 V, V<sub>I</sub> = 2.5 V

3. Dropout voltage is the input-to-output voltage difference at which the output voltage is 100 mV below its nominal value. This specification does not apply to input voltages below 2.5 V

4. Turn-on time is time measured between the enable input just exceeding V<sub>INH</sub> high value and the output voltage just reaching 95% of its nominal value

5. Typical thermal protection hysteresis is 20 °C

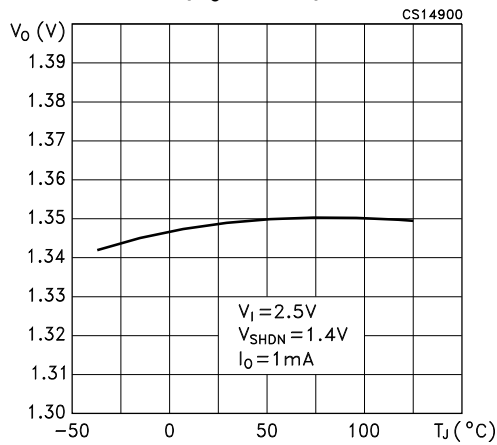
6. The minimum capacitor value is 1 μF, anyway the LD3985 is still stable if the compensation capacitor has a 30% tolerance in all temperature range



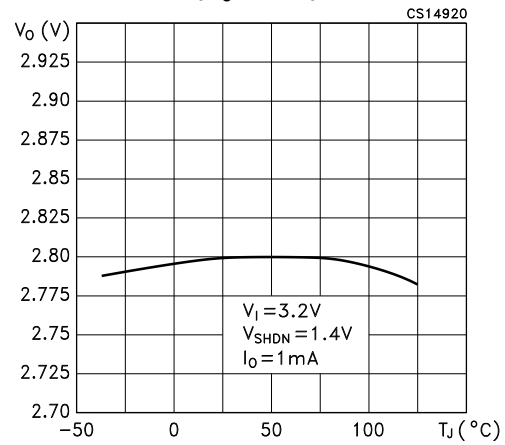
## 6 Typical performance characteristics

$T_J = 25\text{ }^\circ\text{C}$ ,  $V_I = V_{O(NOM)} + 0.5\text{ V}$ ,  $C_I = C_O = 1\text{ }\mu\text{F}$ ,  $C_{BYP} = 10\text{ nF}$ ,  $I_O = 1\text{ mA}$ ,  $V_{INH} = 1.4\text{ V}$ , unless otherwise specified.

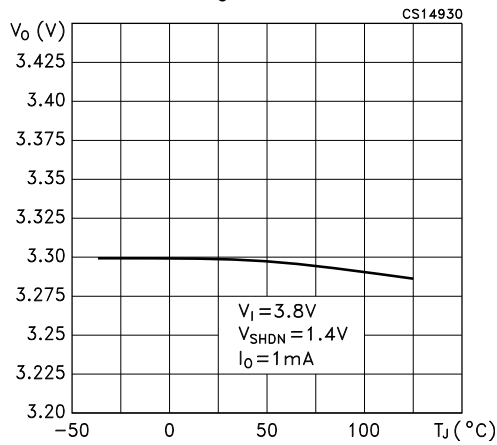
**Figure 4. Output voltage vs. temperature  
( $V_O = 1.35\text{ V}$ )**



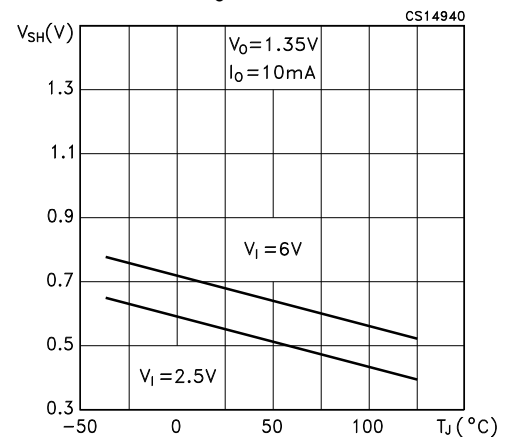
**Figure 5. Output voltage vs. temperature  
( $V_O = 2.7\text{ V}$ )**



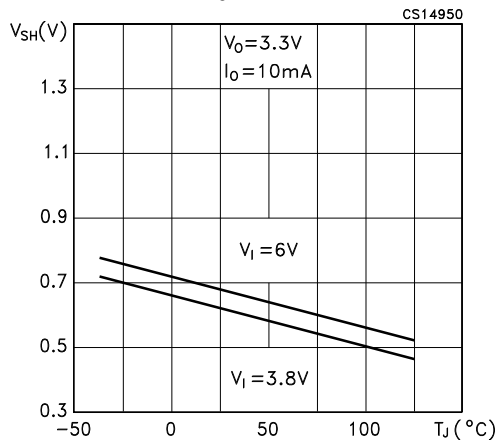
**Figure 6. Output voltage vs. temperature  
( $V_O = 3.3\text{ V}$ )**



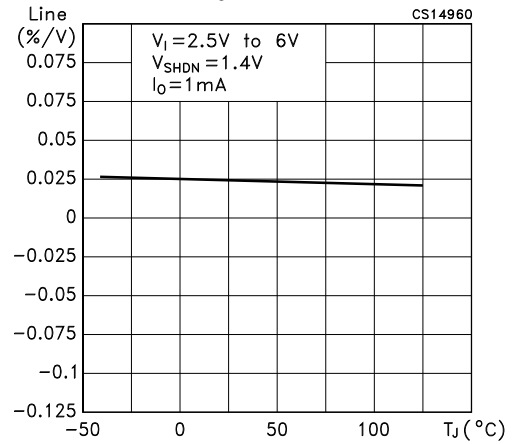
**Figure 7. Shutdown voltage vs. temperature  
( $V_O = 1.35\text{ V}$ )**



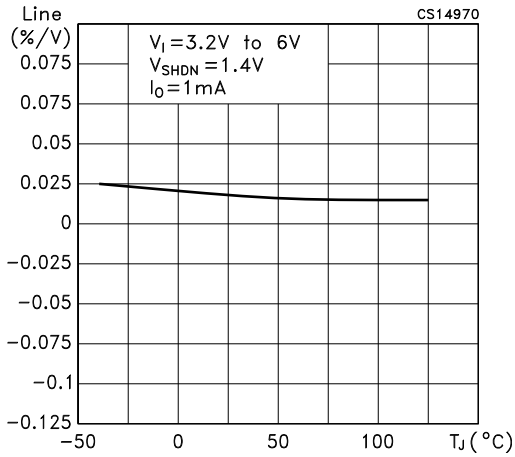
**Figure 8. Shutdown voltage vs. temperature**  
( $V_0=3.3\text{ V}$ )



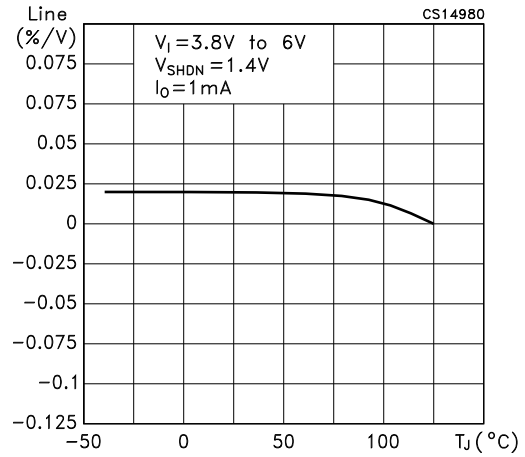
**Figure 9. Line regulation vs. temperature**  
( $V_0=1.35\text{ V}$ )



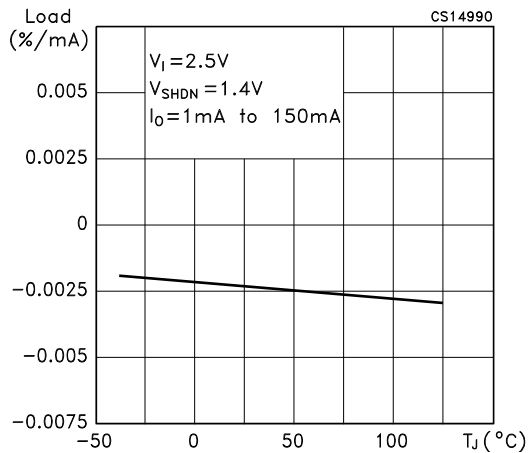
**Figure 10. Line regulation vs. temperature**  
( $V_0=2.7\text{ V}$ )



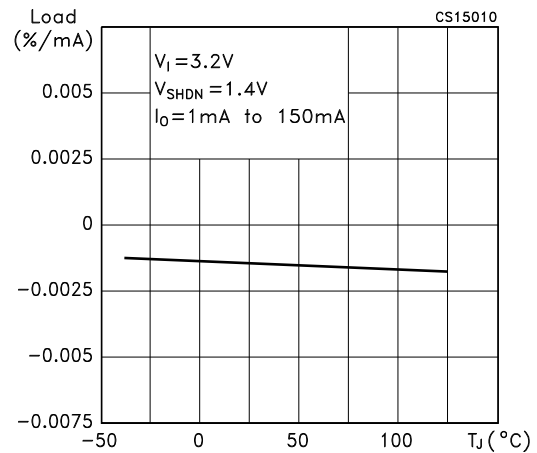
**Figure 11. Line regulation vs. temperature**  
( $V_0=3.3\text{ V}$ )



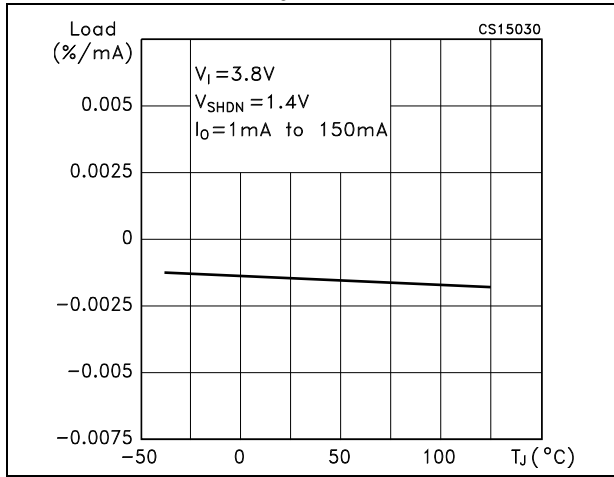
**Figure 12. Load regulation vs. temperature**  
( $V_0=1.35\text{ V}$ )



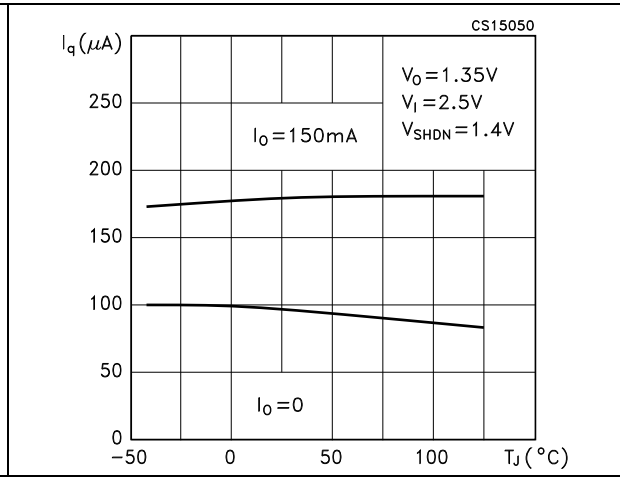
**Figure 13. Load regulation vs. temperature**  
( $V_0=2.7\text{ V}$ )



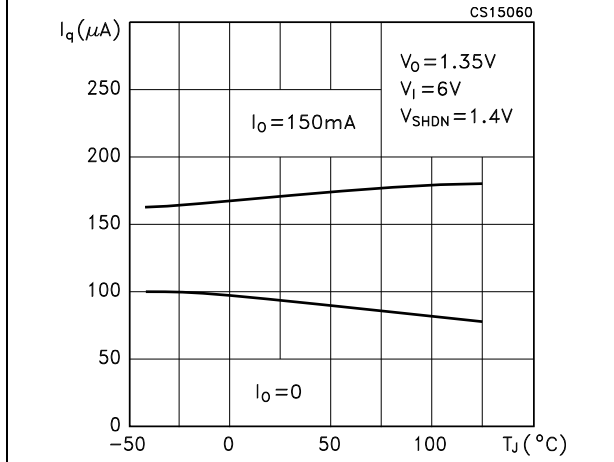
**Figure 14. Load regulation vs. temperature**  
( $V_0=3.3\text{ V}$ )



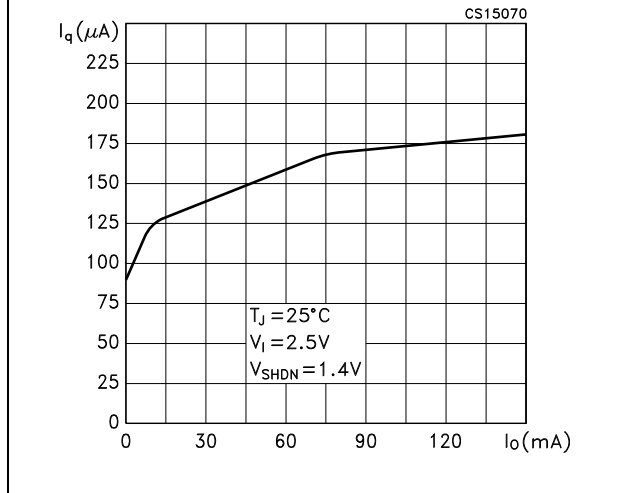
**Figure 15. Quiescent current vs. temperature**  
( $V_i=2.5\text{ V}$ )



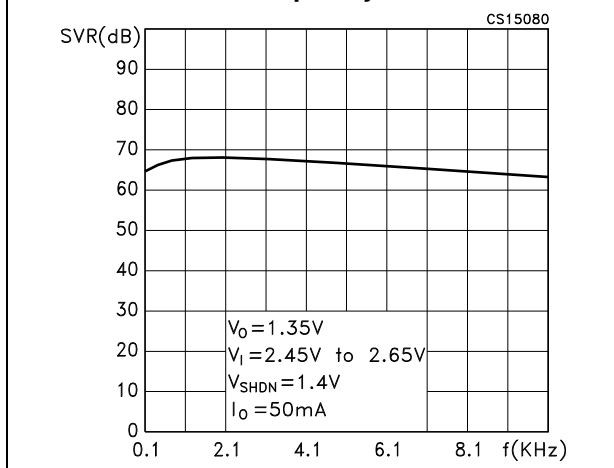
**Figure 16. Quiescent current vs. temperature**  
( $V_i=6\text{ V}$ )



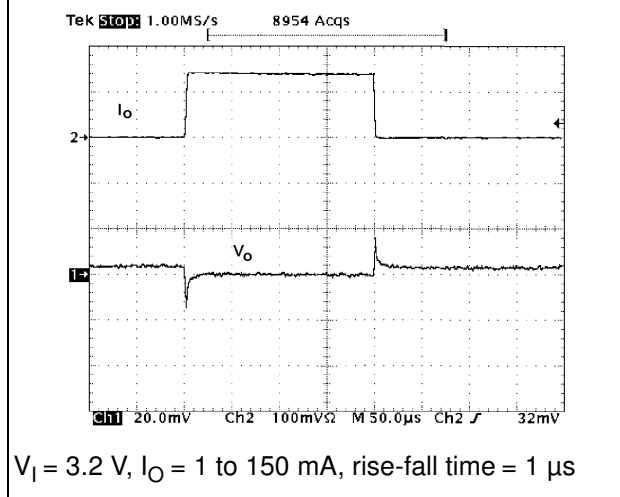
**Figure 17. Quiescent current vs. load current**



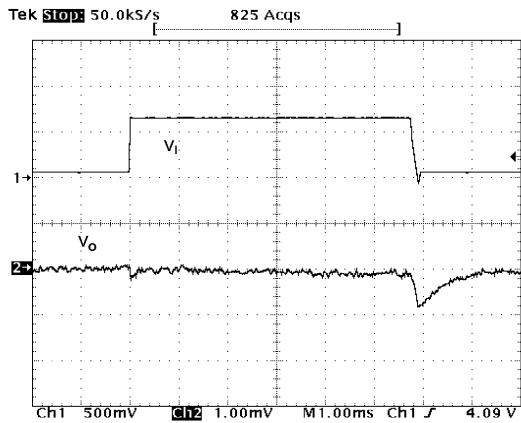
**Figure 18. Supply voltage rejection vs. frequency**



**Figure 19. Load transient response**

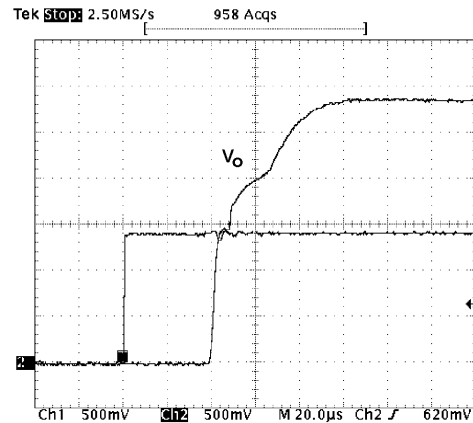


**Figure 20. Line transient response**



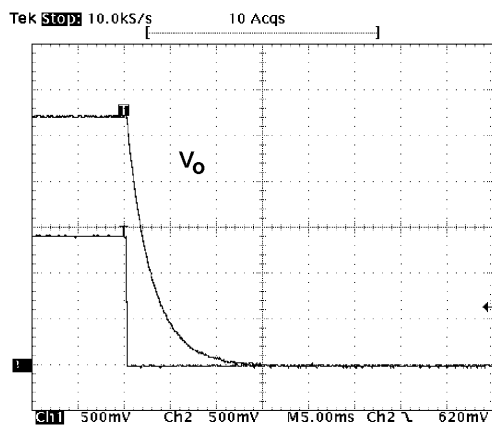
$V_I = 3.8\text{ V to }4.4\text{ V}$ ,  $T_J = 25\text{ }^\circ\text{C}$ ,  $I_O = 150\text{ mA}$ ,  $C_I = C_O = 1\text{ }\mu\text{F}$  (X7R),  $C_{BYP} = 10\text{ nF}$ , rise-fall time =  $1\text{ }\mu\text{s}$ ,  $V_O = 2.7\text{ V}$

**Figure 21. Startup**



$V_I = 3.3\text{ V}$ ,  $I_O = 1\text{ mA}$ ,  $C_I = C_O = 1\text{ }\mu\text{F}$  (cer),  $C_{BYP} = 10\text{ nF}$ ,  $T_r = 20\text{ ns}$ ,  $V_O = 2.8\text{ V}$

**Figure 22. Turn-off**



$V_I = 3.3\text{ V}$ ,  $I_O = 1\text{ mA}$ ,  $C_I = C_O = 1\text{ mF}$  (cer),  $C_{BYP} = 10\text{ nF}$ ,  $T_f = 20\text{ ns}$ ,  $V_O = 2.8\text{ V}$

## 7 Package information

In order to meet environmental requirements, ST offers these devices in different grades of ECOPACK packages, depending on their level of environmental compliance. ECOPACK specifications, grade definitions and product status are available at: [www.st.com](http://www.st.com). ECOPACK is an ST trademark.

### 7.1 SOT23-5L package information

Figure 23. SOT23-5L package outline

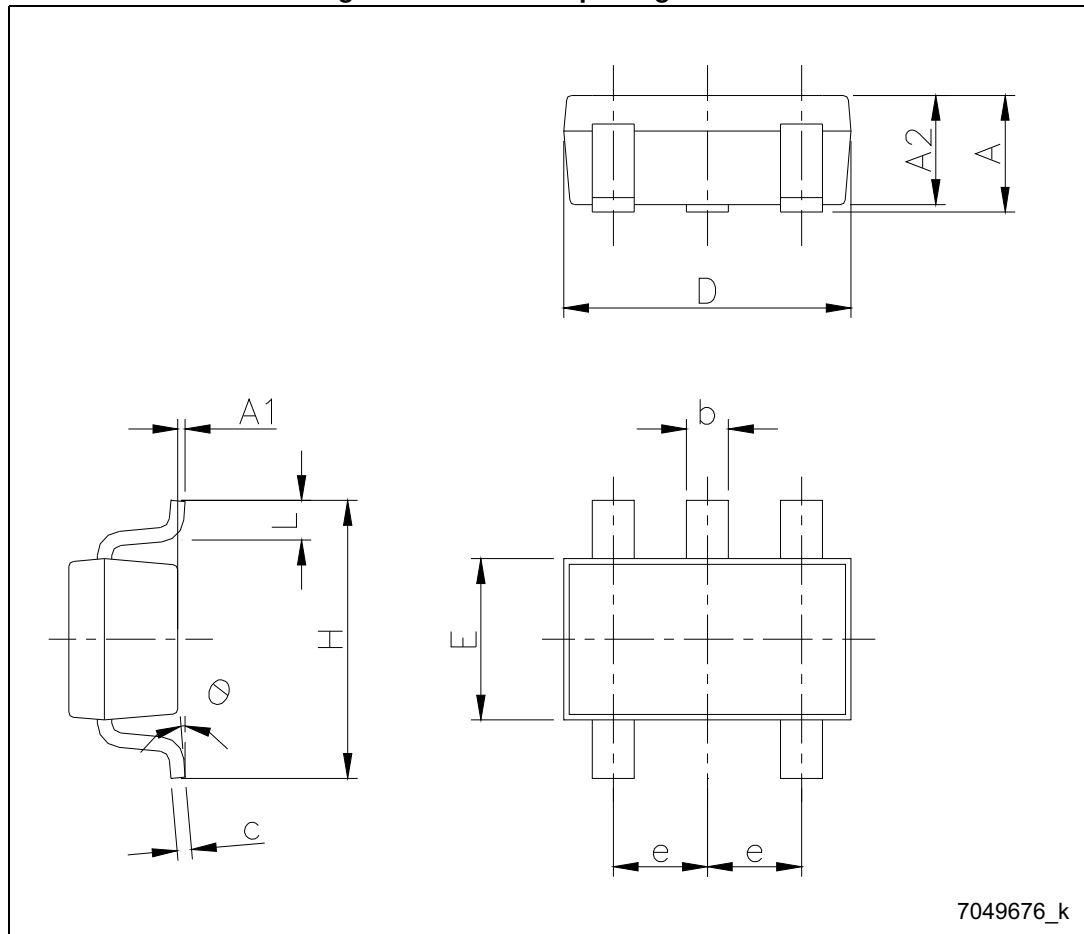
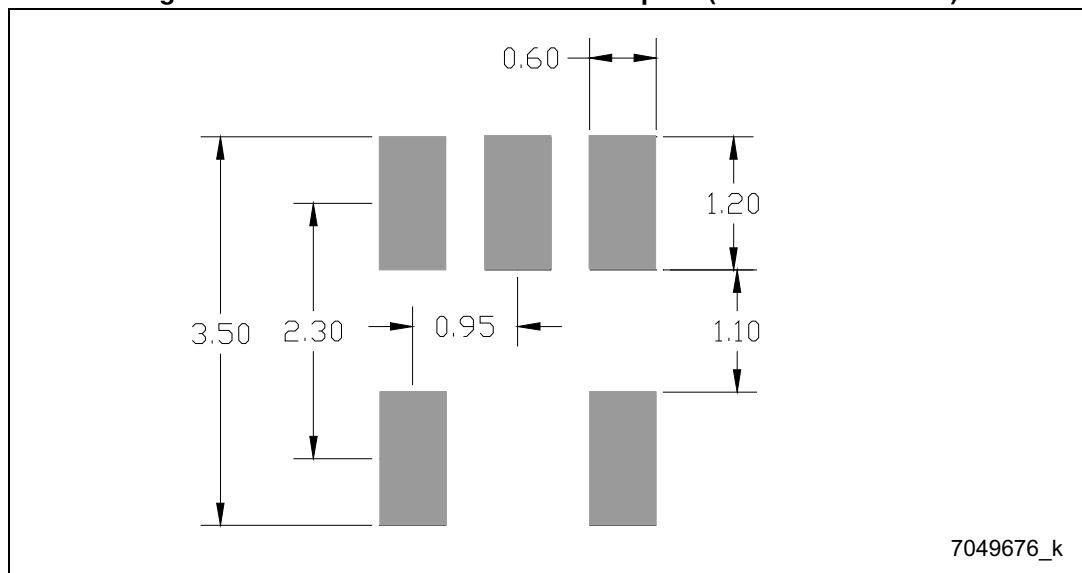


Table 5. SOT23-5L package mechanical data

| Dim.     | mm   |      |      |
|----------|------|------|------|
|          | Min. | Typ. | Max. |
| A        | 0.90 |      | 1.45 |
| A1       | 0    |      | 0.15 |
| A2       | 0.90 |      | 1.30 |
| b        | 0.30 |      | 0.50 |
| c        | 2.09 |      | 0.20 |
| D        |      | 2.95 |      |
| E        |      | 1.60 |      |
| e        |      | 0.95 |      |
| H        |      | 2.80 |      |
| L        | 0.30 |      | 0.60 |
| $\theta$ | 0    |      | 8    |

Figure 24. SOT23-5L recommended footprint (dimensions in mm)



## 7.2 SOT23-5L packing information

Figure 25. SOT23-5L reel mechanical drawing

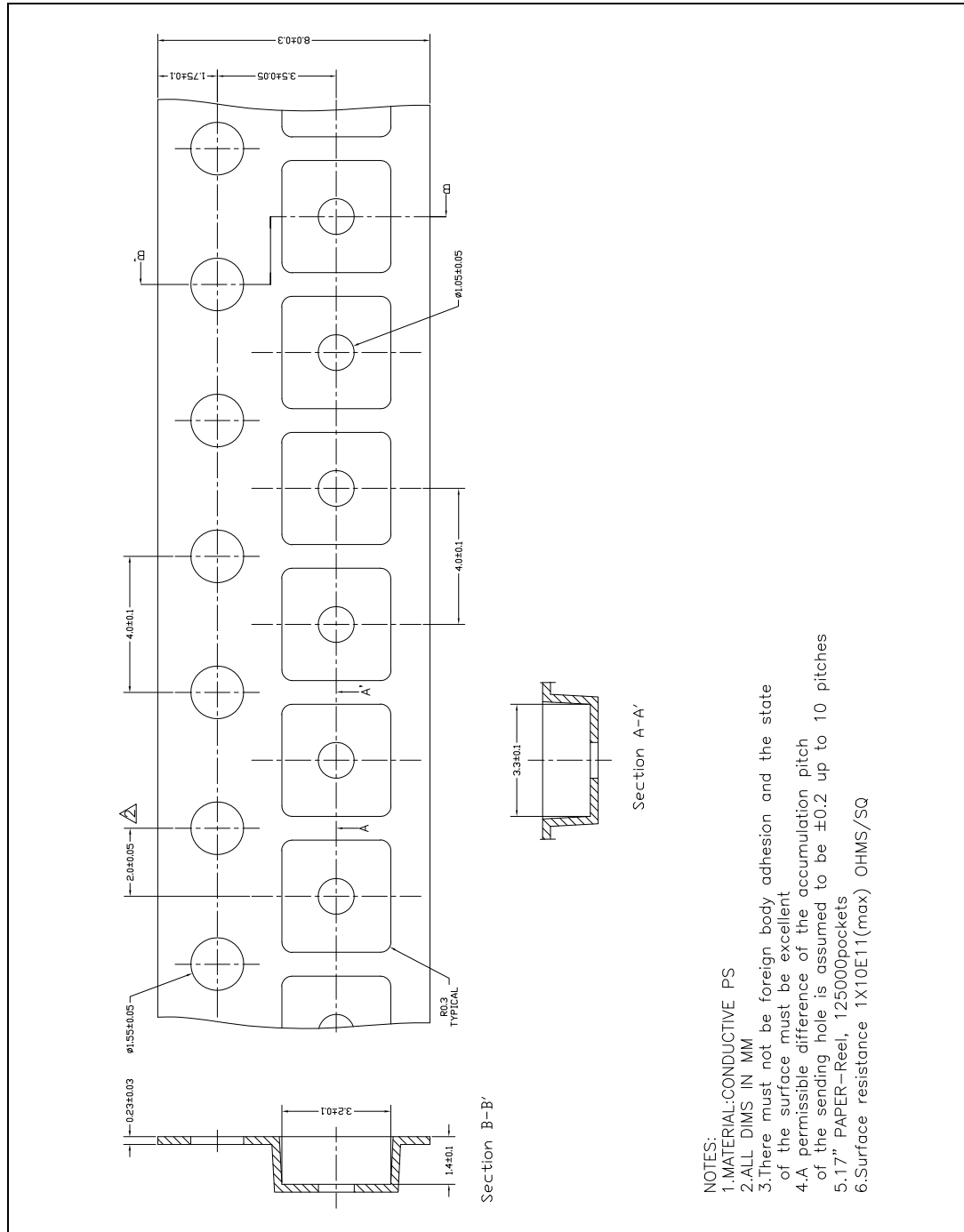


Figure 26. SOT23-5L oriented tape outline

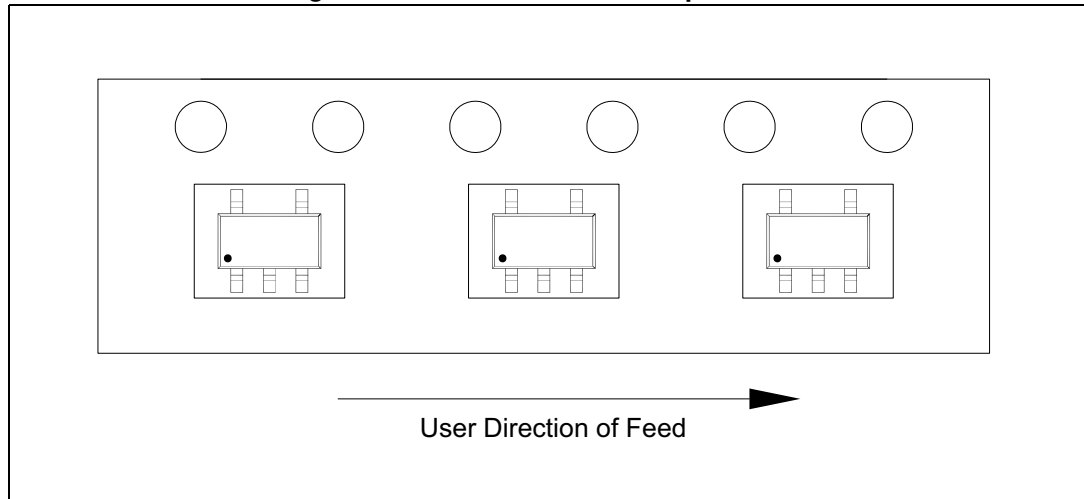


Figure 27. SOT23-5L reel outline

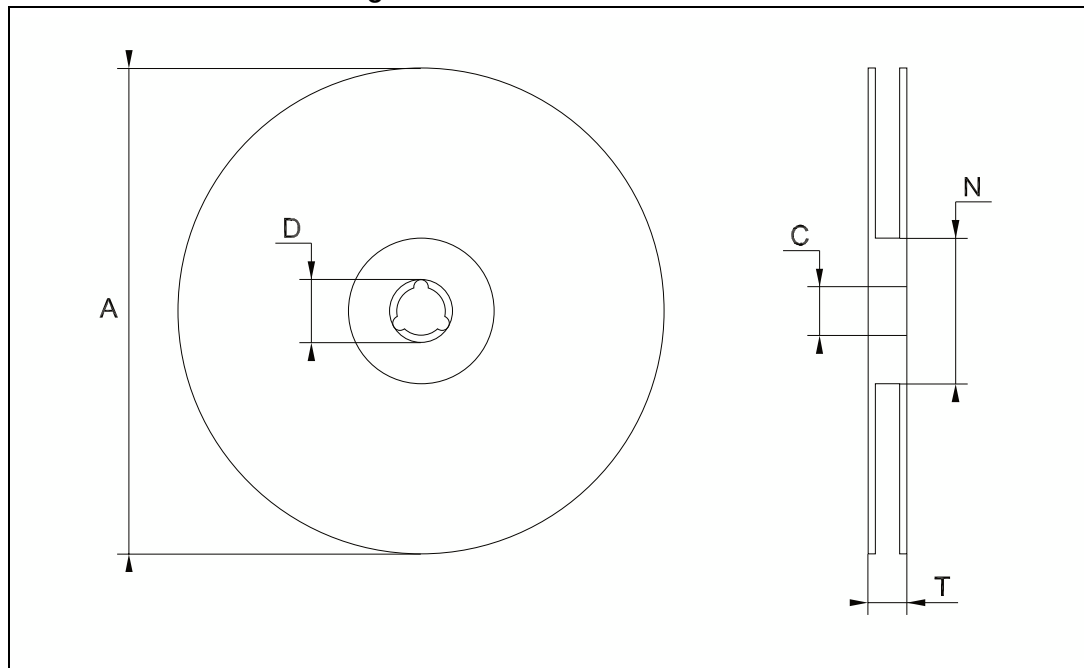


Table 6. SOT23-5L reel mechanical data

| Symbol | Dimensions (mm) |      |      |
|--------|-----------------|------|------|
|        | Min.            | Typ. | Max. |
| A      | -               | -    | 180  |
| C      | 12.8            | 13.0 | 13.2 |
| D      | 20.2            | -    | -    |
| N      | 60              | -    | -    |
| T      | -               | -    | 14.4 |



## 8 Ordering information

Table 7. Ordering information

| Order code  | Output voltage |
|-------------|----------------|
| LD3985M122R | 1.22 V         |
| LD3985M18R  | 1.8 V          |
| LD3985M25R  | 2.5 V          |
| LD3985M27R  | 2.7 V          |
| LD3985M28R  | 2.8 V          |
| LD3985M29R  | 2.9 V          |
| LD3985M30R  | 3.0 V          |
| LD3985M33R  | 3.3 V          |
| LD3985M47R  | 4.7 V          |

## 9 Revision history

**Table 8. Document revision history**

| Date        | Revision | Changes   |
|-------------|----------|---|
| 07-May-2004 | 6        | Part number status changed on table 3.  |
| 05-Oct-2004 | 7        | $t_{ON}$ values are changed on table 5.   |
| 27-Oct-2004 | 8        | Order codes changed - table 3.  |
| 17-Mar-2005 | 9        | Improved drawing quality for figures 19 - 20 - 21 - 22.   |
| 10-Apr-2007 | 10       | Order codes updated.  |
| 08-Jun-2007 | 11       | Order code change.  |
| 20-Dec-2007 | 12       | Modified: <i>Table 1, Table 12</i> , mechanical data for Flip-chip.   |
| 02-Dec-2008 | 13       | Modified: <i>Table 6 on page 14 and Figure 23 on page 17</i> .  |
| 03-Jan-2011 | 14       | Modified: <i>Features on page 1 and Table 12 on page 20</i> .   |
| 08-Jan-2014 | 15       | Part number LD3985XX changed to LD3985.<br>Modified title in cover page.<br>Updated the description and <i>Section 7: Package mechanical data</i> .<br>Added <i>Section 8: Packaging mechanical data</i> .<br>Minor text changes. |
| 20-Jul-2017 | 16       | Removed Flip Chip (1.57x1.22) and TSOT23-5L package information.<br>Removed device summary table.<br>Updated the whole document accordingly.  |
| 28-Nov-2019 | 17       | Updated <a href="#">Section 7.2: SOT23-5L packing information</a> .   |

**IMPORTANT NOTICE – PLEASE READ CAREFULLY**

STMicroelectronics NV and its subsidiaries (“ST”) reserve the right to make changes, corrections, enhancements, modifications, and improvements to ST products and/or to this document at any time without notice. Purchasers should obtain the latest relevant information on ST products before placing orders. ST products are sold pursuant to ST’s terms and conditions of sale in place at the time of order acknowledgement.

Purchasers are solely responsible for the choice, selection, and use of ST products and ST assumes no liability for application assistance or the design of Purchasers’ products.

No license, express or implied, to any intellectual property right is granted by ST herein.

Resale of ST products with provisions different from the information set forth herein shall void any warranty granted by ST for such product.

ST and the ST logo are trademarks of ST. For additional information about ST trademarks, please refer to [www.st.com/trademarks](http://www.st.com/trademarks). All other product or service names are the property of their respective owners.

Information in this document supersedes and replaces information previously supplied in any prior versions of this document.

© 2019 STMicroelectronics – All rights reserved

# Mouser Electronics

Authorized Distributor

Click to View Pricing, Inventory, Delivery & Lifecycle Information:

## STMicroelectronics:

[LD3985J33R](#) [LD3985G27R](#) [LD3985J18R](#) [LD3985J26R](#) [LD3985J28R](#) [LD3985J29R](#) [LD3985G18R](#) [LD3985G25R](#)  
[LD3985G33R](#) [LD3985J25R](#) [LD3985G30R](#) [LD3985G28R](#) [LD3985G47R](#)