

Wall mounted socket - Part no. 1425

- screw terminals
- internal fixing
- one cable entry at top, two blind cable entries (can be cut out) at the bottom
- enclosure base can be turned 180
- sockets are designed for adding an auxiliary contact switch
-

Protection type	IP 44
Ampere	32 A
Poles	4p
Voltage	400
Hertz	50-60Hz
Earth position	6h
Contact	standard
Connection technology	Screw terminals

Std. Pack. 10 Qty.

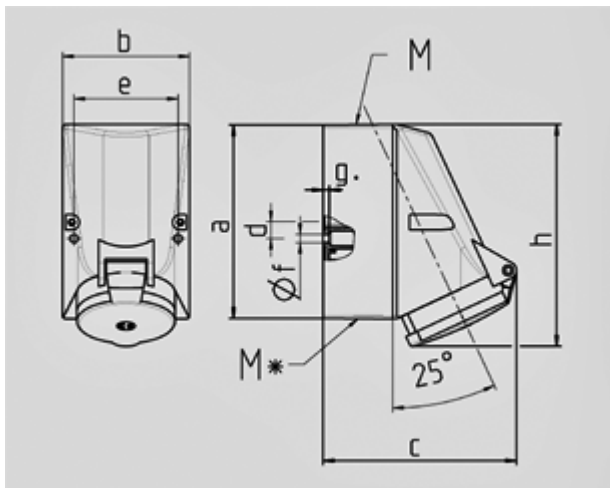

Drawing	Amp.	16		32		
		Poles		3	4	5
1 MB 43		4	5			
Dim. in mm	a	128	128	128	128	128
	b	84	84	84	84	84
	c	122	124	136	136	138
	d	11	11	11	11	11
	e	68	68	68	68	68
	f	5,3	5,3	5,3	5,3	5,3
	g	4	4	4	4	4
	h	144	145	158	158	160
	M	25	25	32	32	32
	M*	2x25 (blind) to be cut out		2x25 (blind) to be cut out		
	Max. cable diam. (mm)	18	18	18/25	18/25	18/25
	Terminal for cond. cross section (mm ²) min.-max.	1,5	1,5	2,5	2,5	2,5
		-4	-4	-10	-10	-10