

# MKKDSN 1,5/ 3-5,08 - PCB terminal block



1726066

<https://www.phoenixcontact.com/us/products/1726066>

Please be informed that the data shown in this PDF document is generated from our Online Catalog. Please find the complete data in the user documentation. Our General Terms of Use for Downloads are valid.



PCB terminal block, nominal current: 13.5 A, rated voltage (III/2): 400 V, nominal cross section: 1.5 mm<sup>2</sup>, number of potentials: 6, number of rows: 2, number of positions per row: 3, product range: MKKDSN 1,5, pitch: 5.08 mm, connection method: Screw connection with tension sleeve, screw head form: L Slotted, mounting: Wave soldering, conductor/PCB connection direction: 0 °, color: green, Pin layout: Linear pinning, Solder pin [P]: 3.5 mm, number of solder pins per potential: 1, type of packaging: packed in cardboard. The article can be aligned to create different nos. of positions!

## Your advantages

- Well-known connection principle allows worldwide use
- Low temperature rise, thanks to maximum contact force
- Allows connection of two conductors
- Extremely small design for the respective conductor cross section
- Conductor connection on several levels enables higher contact density
- The latching on the side enables various numbers of positions to be combined

## Commercial Data

Item number	1726066
Packing unit	1 pc
Minimum order quantity	250 pc
Sales Key	AA12
Product Key	AALFJL
Catalog Page	Page 93 (C-1-2013)
GTIN	4017918025373
Weight per Piece (including packing)	6.824 g
Weight per Piece (excluding packing)	6.354 g
Customs tariff number	85369010
Country of origin	CN

# MKKDSN 1,5/ 3-5,08 - PCB terminal block

1726066

<https://www.phoenixcontact.com/us/products/1726066>

## Technical Data

### Dimensions

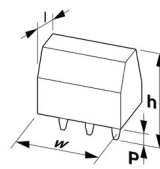
Dimensional drawing	
Pitch	5.08 mm
Width [w]	17.78 mm
Height [h]	22.6 mm
Length [l]	18.3 mm
Installed height	19.1 mm
Solder pin length [P]	3.5 mm

# MKKDSN 1,5/ 3-5,08 - PCB terminal block

1726066

<https://www.phoenixcontact.com/us/products/1726066>

## Drawings

Drilling plan/solder pad geometry

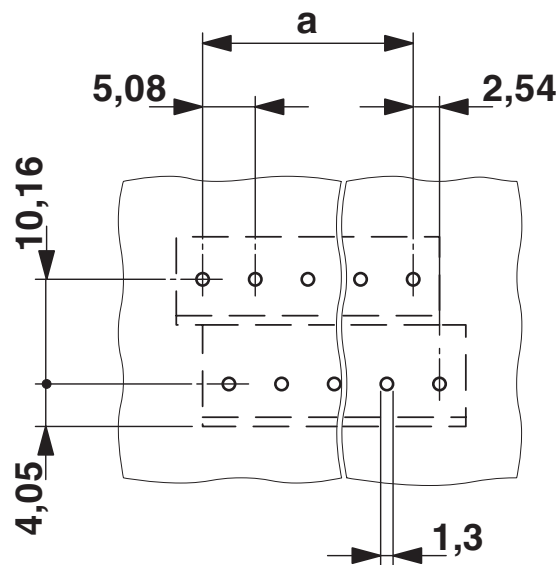

Dimensional drawing

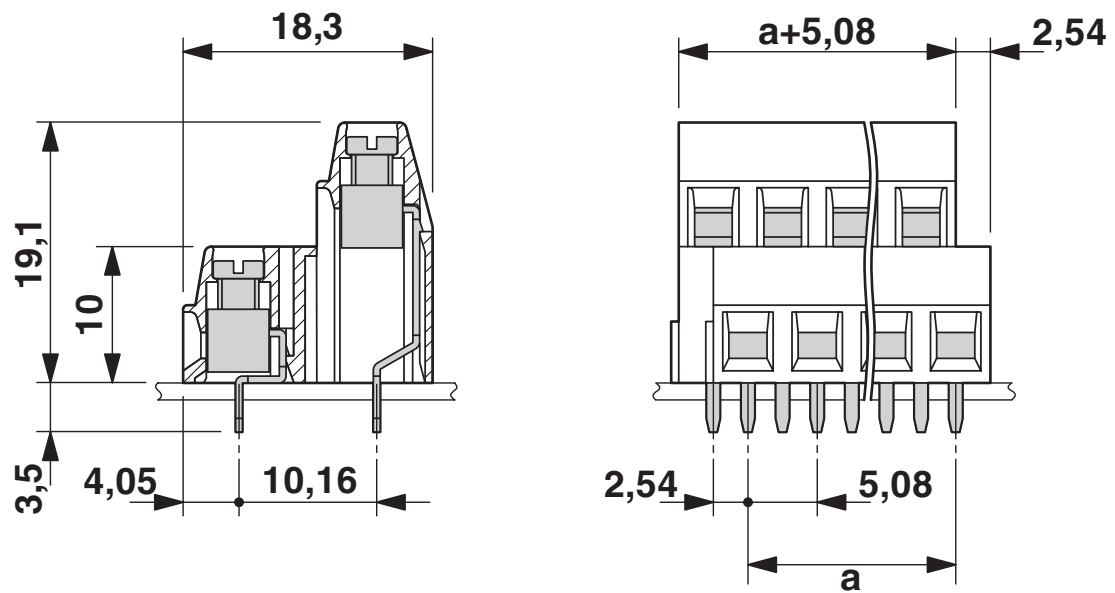

# MKKDSN 1,5/ 3-5,08 - PCB terminal block



1726066

<https://www.phoenixcontact.com/us/products/1726066>

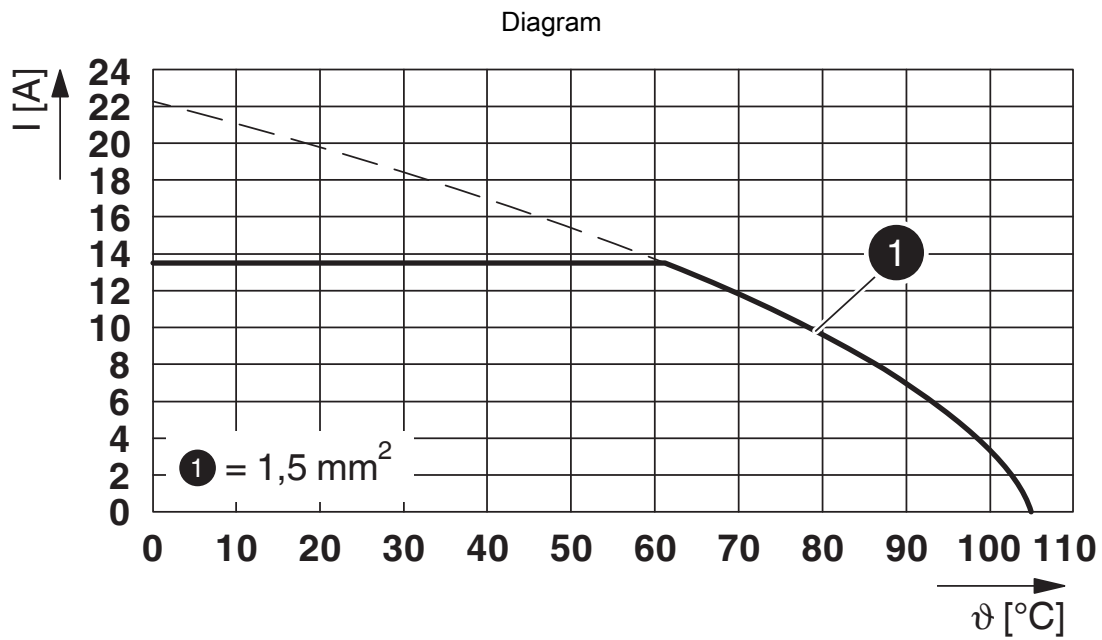

Type: MKKDSN 1,5/...-5,08

# MKKDSN 1,5/ 3-5,08 - PCB terminal block



1726066

<https://www.phoenixcontact.com/us/products/1726066>

## Approvals



**CSA**

Approval ID: 13631



**EAC**

Approval ID: B.01687



**cULus Recognized**

Approval ID: E60425-19770427

	Nominal Voltage $U_N$	Nominal Current $I_N$	Cross Section AWG	Cross Section $\text{mm}^2$
Use group B				
Multi-conductor connection	300 V	10 A	2x - 18	-
Screw connection	300 V	10 A	30 - 14	-
Use group D				
Multi-conductor connection	300 V	10 A	2x - 18	-
Screw connection	300 V	10 A	30 - 14	-



**IECEE CB Scheme**

Approval ID: DE1-66542



**VDE Zeichengenehmigung**

Approval ID: 40055535

# MKKDSN 1,5/ 3-5,08 - PCB terminal block



1726066

<https://www.phoenixcontact.com/us/products/1726066>

## Classifications

### ECLASS

ECLASS-10.0.1	27440401
ECLASS-11.0	27460101
ECLASS-12.0	27460101

### ETIM

ETIM 8.0	EC002643
----------	----------

### UNSPSC

UNSPSC 21.0	39121400
-------------	----------

# MKKDSN 1,5/ 3-5,08 - PCB terminal block



1726066

<https://www.phoenixcontact.com/us/products/1726066>

## Environmental Product Compliance

REACH SVHC	Lead 7439-92-1
China RoHS	Environmentally Friendly Use Period = 50 years
	For information on hazardous substances, refer to the manufacturer's declaration available under "Downloads"

# MKKDSN 1,5/ 3-5,08 - PCB terminal block

1726066

<https://www.phoenixcontact.com/us/products/1726066>

## Accessories

 Note: Applying some accessories below might limit this product.

### EBP 2- 5 - Insertion bridge

1733169

<https://www.phoenixcontact.com/us/products/1733169>

Insertion bridge for connectors with 5.0 mm or 5.08 mm pitch



 Max. current carrying capacity: 12 A

### EBP 3- 5 - Insertion bridge

1733172

<https://www.phoenixcontact.com/us/products/1733172>

Insertion bridge for connectors with 5.0 mm or 5.08 mm pitch



 Max. current carrying capacity: 12 A



# MKKDSN 1,5/ 3-5,08 - PCB terminal block



1726066

<https://www.phoenixcontact.com/us/products/1726066>

## SZS 0,6X3,5 - Screwdriver

1205053

<https://www.phoenixcontact.com/us/products/1205053>



Actuation tool, for ST terminal blocks, insulated, also suitable for use as a bladed screwdriver, size: 0.6 x 3.5 x 100 mm, 2-component grip, with non-slip grip

## SK 5,08/3,8:FORTL.ZAHLEN - Marker card

0804293

<https://www.phoenixcontact.com/us/products/0804293>

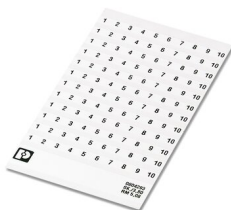

Marker card, white, labeled, horizontal: consecutive numbers 1 ... 10, 11 ... 20, etc. up to 91 ... (99)100, mounting type: adhesive, for terminal block width: 5.08 mm, lettering field size: 5.08 x 3.8 mm

# MKKDSN 1,5/ 3-5,08 - PCB terminal block



1726066

<https://www.phoenixcontact.com/us/products/1726066>

## SK 5,08/3,8:UNBEDRUCKT - Marker card

0805412

<https://www.phoenixcontact.com/us/products/0805412>

Marker card, white, unlabeled, can be labeled with: Marker pen, mounting type: adhesive, for terminal block width: 5.08 mm, lettering field size: 5.08 x 3.8 mm



---

Phoenix Contact 2023 © - all rights reserved

<https://www.phoenixcontact.com>

Phoenix Contact USA  
586 Fulling Mill Road  
Middletown, PA 17057, United States  
(+717) 944-1300  
[info@phoenixcon.com](mailto:info@phoenixcon.com)