

Features

- $BV_{CEO} > -45V$
- $I_C = -100mA$ High Collector Current
- $P_D = 925mW$ Power Dissipation
- $0.36mm^2$ Package Footprint, 40% Smaller than DFN1006
- 0.4mm Height Package Minimizing Off-Board Profile
- Complementary NPN Type BC847BFZ
- **Totally Lead-Free & Fully RoHS Compliant (Notes 1 & 2)**
- **Halogen and Antimony Free. "Green" Device (Note 3)**

Mechanical Data

- Case: X2-DFN0606-3
- Case Material: Molded Plastic, "Green" Molding Compound. UL Flammability Classification Rating 94V-0
- Moisture Sensitivity: Level 1 per J-STD-020
- Terminals: Finish — NiPdAu, Solderable per MIL-STD-202, Method 208 
- Weight: 0.0008 grams (Approximate)

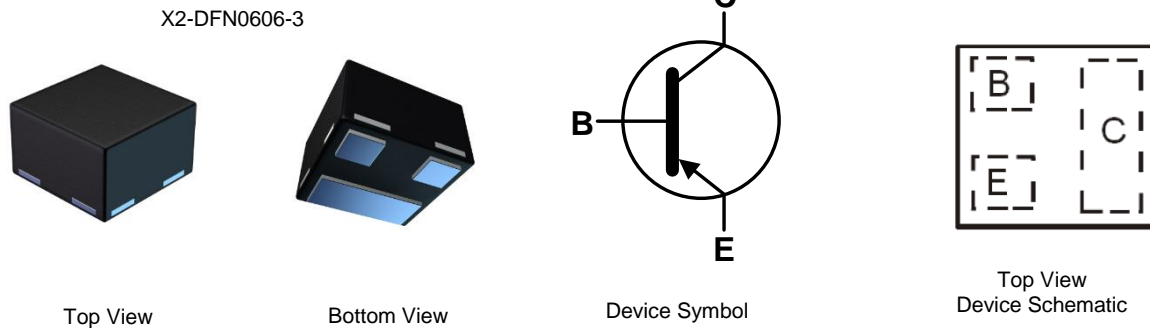

Ordering Information (Note 4)

| Product | Marking | Reel size (inches) | Tape width (mm) | Quantity per reel |
|-------------|---------|--------------------|-----------------|-------------------|
| BC857BFZ-7B | 3W | 7 | 8 | 10,000 |

- Notes:
1. No purposely added lead. Fully EU Directive 2002/95/EC (RoHS) & 2011/65/EU (RoHS 2) compliant.
 2. See http://www.diodes.com/quality/lead_free.html for more information about Diodes Incorporated's definitions of Halogen- and Antimony-free, "Green" and Lead-free.
 3. Halogen- and Antimony-free "Green" products are defined as those which contain <900ppm bromine, <900ppm chlorine (<1500ppm total Br + Cl) and <1000ppm antimony compounds.
 4. For packaging details, go to our website at <http://www.diodes.com/products/packages.html>.

Marking Information

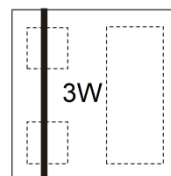

3W = Product Type Marking Code

Top View
Bar Denotes Base and Emitter Side

Absolute Maximum Ratings (@T_A = +25°C, unless otherwise specified.)

| Characteristic | Symbol | Value | Unit |
|------------------------------|------------------|-------|------|
| Collector-Base Voltage | V _{CBO} | -50 | V |
| Collector-Emitter Voltage | V _{CEO} | -45 | V |
| Emitter-Base Voltage | V _{EBO} | -6.0 | V |
| Continuous Collector Current | I _C | -100 | mA |
| Peak Pulse Collector Current | I _{CM} | -200 | mA |

Thermal Characteristics (@T_A = +25°C, unless otherwise specified.)

| Characteristic | Symbol | Value | Unit |
|---|-----------------------------------|-------------|------|
| Power Dissipation | P _D | (Note 5) | 270 |
| | | (Note 6) | 925 |
| Thermal Resistance, Junction to Ambient | R _{θJA} | (Note 5) | 465 |
| | | (Note 6) | 135 |
| Thermal Resistance, Junction to Lead | R _{θJL} | 135 | °C/W |
| Operating and Storage and Temperature Range | T _J , T _{STG} | -55 to +150 | °C |

ESD Ratings (Note 8)

| Characteristic | Symbol | Value | Unit | JEDEC Class |
|--|---------|-------|------|-------------|
| Electrostatic Discharge - Human Body Model | ESD HBM | 4,000 | V | 3A |
| Electrostatic Discharge - Machine Model | ESD MM | 200 | V | B |

- Notes:
5. For the device mounted on minimum recommended pad layout 1oz copper that is on a single-sided 1.6mm FR4 PCB; device is measured under still air conditions whilst operating in steady state condition. The entire exposed collector pad is attached to the heatsink.
 6. Same as Note 5, except the exposed collector pad is mounted on 25mm x 25mm 2oz copper.
 7. Thermal resistance from junction to solder-point (on the exposed collector pad).
 8. Refer to JEDEC specification JESD22-A114 and JESD22-A115.

Thermal Characteristics and Derating Information

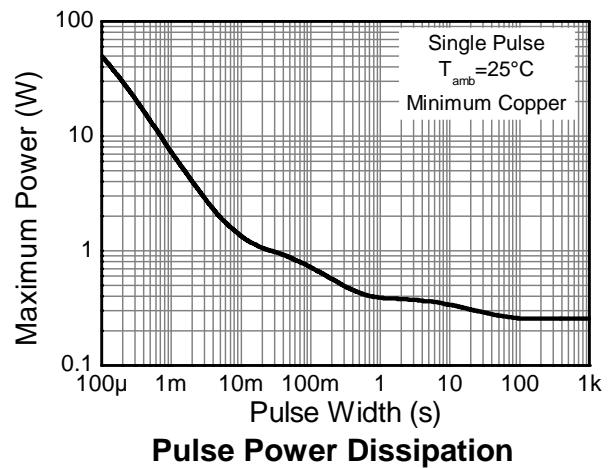
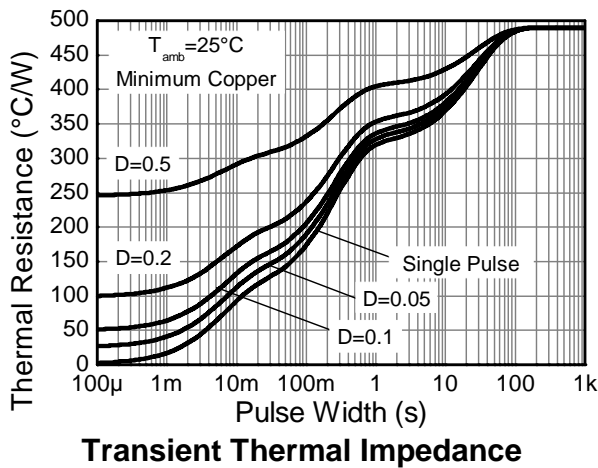
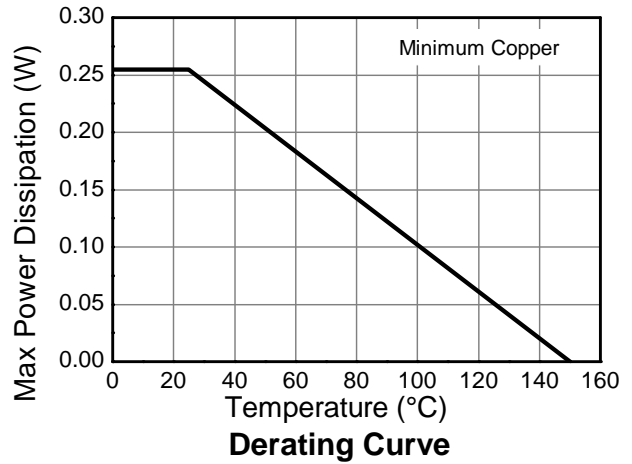
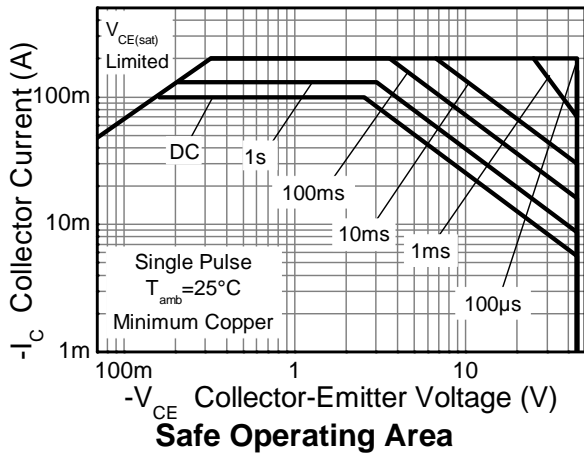

Electrical Characteristics (@T_A = +25°C, unless otherwise specified.)

| Characteristic | Symbol | Min | Typical | Max | Unit | Test Condition |
|--|----------------------|-----------|--------------|------------------|------|---|
| OFF CHARACTERISTICS | | | | | | |
| Collector-Base Breakdown Voltage | BV _{CB0} | -50 | -100 | — | V | I _C = -50μA, I _B = 0 |
| Collector-Emitter Breakdown Voltage | BV _{CES} | -50 | -90 | — | V | I _C = -50μA, I _B = 0 |
| Collector-Emitter Breakdown Voltage (Note 9) | BV _{CEO} | -45 | -65 | — | V | I _C = -1mA, I _B = 0 |
| Collector-Base Breakdown Voltage | BV _{EBO} | -6.0 | -8.5 | — | V | I _E = -50μA, I _C = 0 |
| Collector-Base Cutoff Current | I _{CB0} | — | — | -15 | nA | V _{CB} = -40V |
| Collector-Emitter Cutoff Current | I _{CES} | — | — | -15 | nA | V _{CE} = -40V |
| ON CHARACTERISTICS (Note 9) | | | | | | |
| DC Current Gain | h _{FE} | — 200 | 340 330 | — 470 | — | I _C = -10μA, V _{CE} = -5.0V I _C = -2.0mA, V _{CE} = -5.0V |
| Collector-Emitter Saturation Voltage | V _{CE(sat)} | — | -70 -300 | -175 -500 | mV | I _C = -10mA, I _B = -0.5mA I _C = -100mA, I _B = -5.0mA |
| Base-Emitter Saturation Voltage | V _{BE(sat)} | — | -760 -885 | -1,000 -1,100 | mV | I _C = -10mA, I _B = -0.5mA I _C = -100mA, I _B = -5.0mA |
| Base-Emitter Voltage | V _{BE(on)} | -600 — | -670 -715 | -780 -850 | mV | I _C = -2.0mA, V _{CE} = -5V I _C = -10mA, V _{CE} = -5V |
| SMALL SIGNAL CHARACTERISTICS | | | | | | |
| Output Capacitance | C _{obo} | — | 2.0 | — | pF | V _{CB} = -10.0V, f = 1.0MHz, I _E = 0 |
| Current Gain-Bandwidth Product | f _T | 100 | 270 | — | MHz | V _{CE} = -5V, I _C = -10mA, f = 100MHz |

Note: 9. Measured under pulsed conditions. Pulse width ≤ 300μs. Duty cycle ≤ 2%.

Typical Electrical Characteristics (@ $T_A = +25^\circ\text{C}$, unless otherwise specified.)

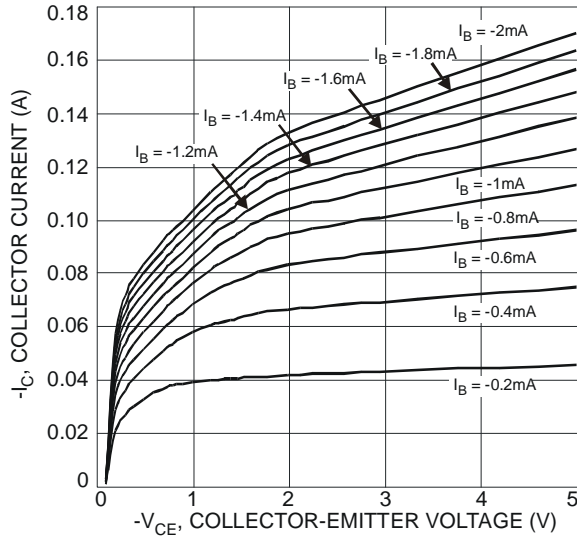

Fig. 4 Typical Collector Current vs. Collector-Emitter Voltage

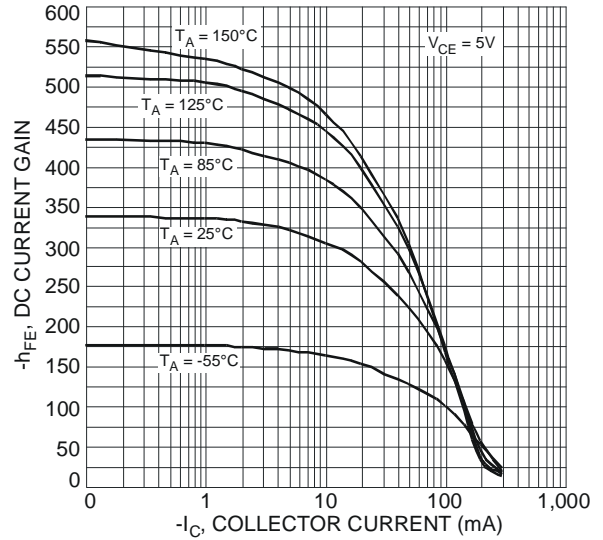

Fig. 5 Typical DC Current Gain vs. Collector Current

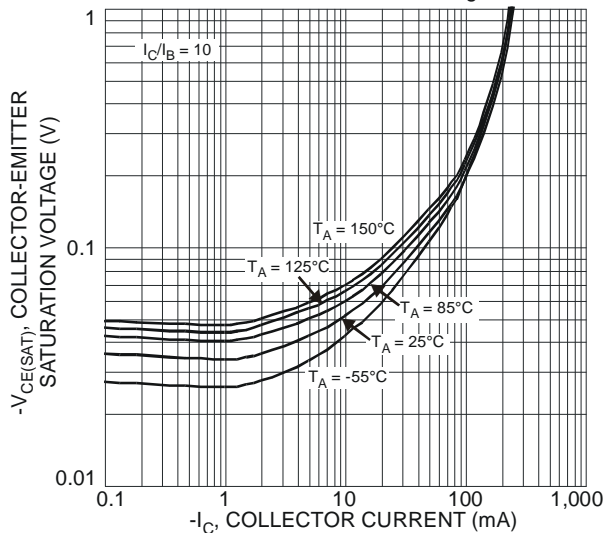

Fig. 6 Typical Collector-Emitter Saturation Voltage vs. Collector Current

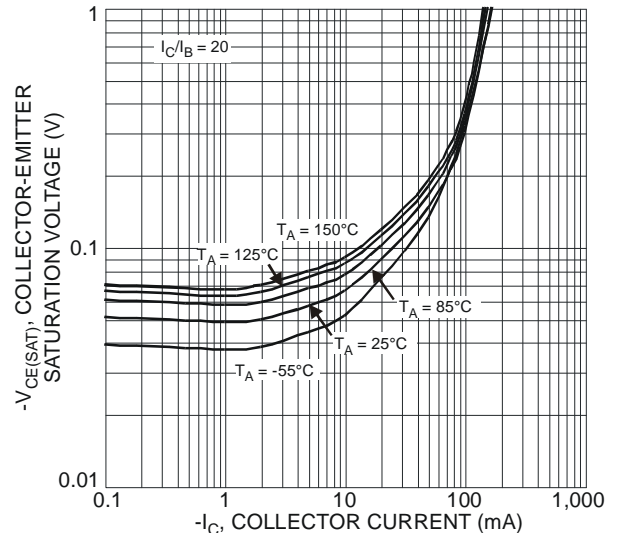

Fig. 7 Typical Collector-Emitter Saturation Voltage vs. Collector Current

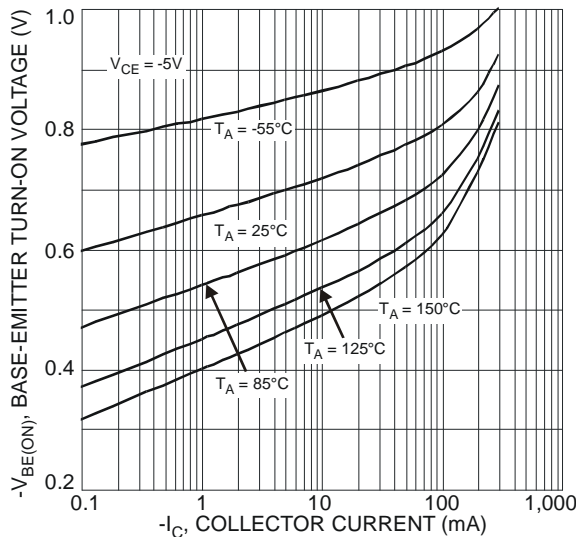

Fig. 8 Typical Base-Emitter Turn-On Voltage vs. Collector Current

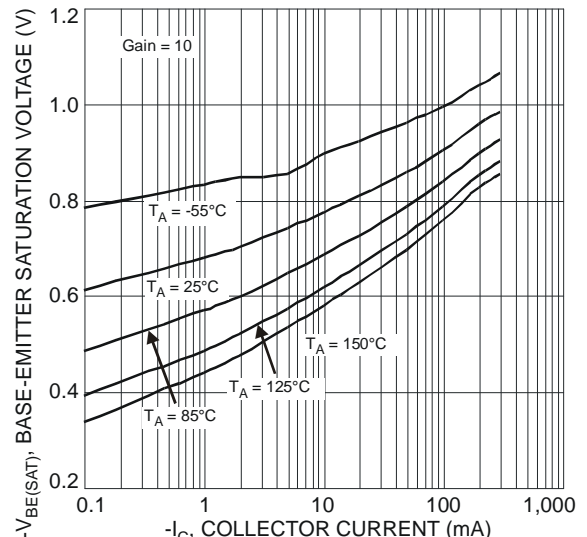
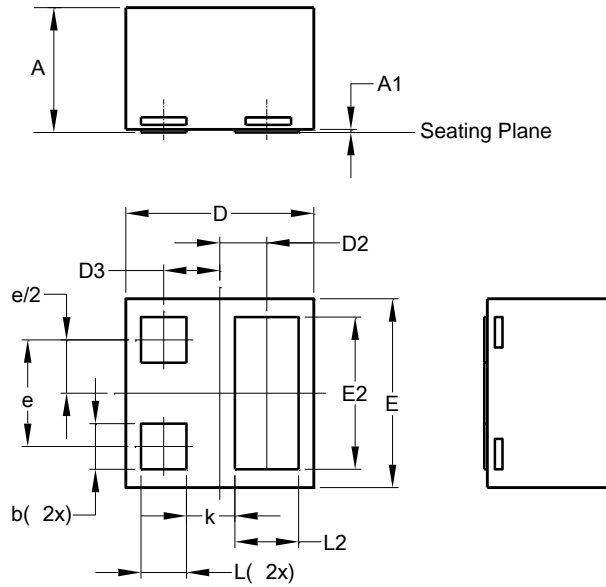

Fig. 9 Typical Base-Emitter Saturation Voltage vs. Collector Current

Package Outline Dimensions

Please see AP02002 at <http://www.diodes.com/datasheets/ap02002.pdf> for the latest version.



| X2-DFN0606-3 | | | |
|----------------------|-----------|------|------|
| Dim | Min | Max | Typ |
| A | 0.36 | 0.42 | 0.39 |
| A1 | 0 | 0.05 | 0.02 |
| b | 0.10 | 0.20 | 0.15 |
| D | 0.57 | 0.67 | 0.62 |
| D2 | 0.155 BSC | | |
| D3 | 0.185 BSC | | |
| E | 0.57 | 0.67 | 0.62 |
| E2 | 0.40 | 0.60 | 0.50 |
| e | 0.35 BSC | | |
| k | 0.16 REF | | |
| L | 0.09 | 0.21 | 0.15 |
| L2 | 0.11 | 0.31 | 0.21 |
| All Dimensions in mm | | | |

Suggested Pad Layout

Please see AP02001 at <http://www.diodes.com/datasheets/ap02001.pdf> for the latest version.

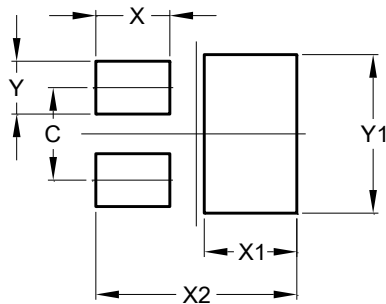

| Dimensions | Value (in mm) |
|------------|---------------|
| C | 0.350 |
| X | 0.280 |
| X1 | 0.350 |
| X2 | 0.760 |
| Y | 0.200 |
| Y1 | 0.600 |

IMPORTANT NOTICE

DIODES INCORPORATED MAKES NO WARRANTY OF ANY KIND, EXPRESS OR IMPLIED, WITH REGARDS TO THIS DOCUMENT, INCLUDING, BUT NOT LIMITED TO, THE IMPLIED WARRANTIES OF MERCHANTABILITY AND FITNESS FOR A PARTICULAR PURPOSE (AND THEIR EQUIVALENTS UNDER THE LAWS OF ANY JURISDICTION).

Diodes Incorporated and its subsidiaries reserve the right to make modifications, enhancements, improvements, corrections or other changes without further notice to this document and any product described herein. Diodes Incorporated does not assume any liability arising out of the application or use of this document or any product described herein; neither does Diodes Incorporated convey any license under its patent or trademark rights, nor the rights of others. Any Customer or user of this document or products described herein in such applications shall assume all risks of such use and will agree to hold Diodes Incorporated and all the companies whose products are represented on Diodes Incorporated website, harmless against all damages.

Diodes Incorporated does not warrant or accept any liability whatsoever in respect of any products purchased through unauthorized sales channel. Should Customers purchase or use Diodes Incorporated products for any unintended or unauthorized application, Customers shall indemnify and hold Diodes Incorporated and its representatives harmless against all claims, damages, expenses, and attorney fees arising out of, directly or indirectly, any claim of personal injury or death associated with such unintended or unauthorized application.

Products described herein may be covered by one or more United States, international or foreign patents pending. Product names and markings noted herein may also be covered by one or more United States, international or foreign trademarks.

This document is written in English but may be translated into multiple languages for reference. Only the English version of this document is the final and determinative format released by Diodes Incorporated.

LIFE SUPPORT

Diodes Incorporated products are specifically not authorized for use as critical components in life support devices or systems without the express written approval of the Chief Executive Officer of Diodes Incorporated. As used herein:

A. Life support devices or systems are devices or systems which:

1. are intended to implant into the body, or
2. support or sustain life and whose failure to perform when properly used in accordance with instructions for use provided in the labeling can be reasonably expected to result in significant injury to the user.

B. A critical component is any component in a life support device or system whose failure to perform can be reasonably expected to cause the failure of the life support device or to affect its safety or effectiveness.

Customers represent that they have all necessary expertise in the safety and regulatory ramifications of their life support devices or systems, and acknowledge and agree that they are solely responsible for all legal, regulatory and safety-related requirements concerning their products and any use of Diodes Incorporated products in such safety-critical, life support devices or systems, notwithstanding any devices- or systems-related information or support that may be provided by Diodes Incorporated. Further, Customers must fully indemnify Diodes Incorporated and its representatives against any damages arising out of the use of Diodes Incorporated products in such safety-critical, life support devices or systems.

Copyright © 2015, Diodes Incorporated

www.diodes.com

Mouser Electronics

Authorized Distributor

Click to View Pricing, Inventory, Delivery & Lifecycle Information:

[Diodes Incorporated:](#)

[BC857BFZ-7B](#)