

Description

Available in through-hole package, the Triac T435T-600FP is suitable for general purpose AC switching.

Specially designed for power tool applications, it can also be used to drive loads like motor speed controller, and kitchen equipment such as electro valves, light dimmers and similar.

Features

- High static and dynamic commutation
- Package is RoHS (2002/95/EC) compliant
- $I_{GT} = 35 \text{ mA}$
- ECOPACK^{®2} compliant component
- Provides UL certified insulation rate at 2.0 kV rms

TM: Snubberless is a trademark of STMicroelectronics

1 Characteristics

Table 1. Absolute maximum ratings (limiting values)

Symbol	Parameter		Value	Unit	
$I_{T(RMS)}$	On-state rms current (full sine wave)		$T_c = 105\text{ °C}$	4	A
I_{TSM}	Non repetitive surge peak on-state current (full cycle sine wave, T_j initial = 25 °C)	F = 60 Hz	t = 16.7 ms	32	A
		F = 50 Hz	t = 20 ms	30	
I^2t	I^2t Value for fusing	$t_p = 10\text{ ms}$		6	A ² s
dI/dt	Critical rate of rise of on-state current $I_G = 2 \times I_{GT}$, $t_r \leq 100\text{ ns}$	F = 120 Hz	$T_j = 125\text{ °C}$	50	A/ μ s
V_{DSM}/V_{RSM}	Non repetitive surge peak off-state voltage	$t_p = 10\text{ ms}$	$T_j = 25\text{ °C}$	$V_{DRM}/V_{RRM} + 100$	V
I_{GM}	Peak gate current	$t_p = 20\text{ }\mu$ s	$T_j = 125\text{ °C}$	4	A
$P_{G(AV)}$	Average gate power dissipation	$T_j = 125\text{ °C}$		1	W
T_{stg}	Storage junction temperature range			-40 to +150	°C
T_j	Operating junction temperature range			-40 to +125	

**Table 2. Electrical characteristics, Snubberless (3 quadrants)
($T_j = 25\text{ °C}$, unless otherwise specified)**

Symbol	Test conditions	Quadrant		Value	Unit
$I_{GT}^{(1)}$	$V_D = 12\text{ V}$ $R_L = 30\text{ }\Omega$	I - II - III	MAX	35	mA
V_{GT}	$V_D = 12\text{ V}$ $R_L = 30\text{ }\Omega$	I - II - III	MAX	1.3	V
V_{GD}	$V_D = V_{DRM}$ $R_L = 3.3\text{ k}\Omega$	I - II - III	MIN	0.2	V
$I_H^{(2)}$	$I_T = 100\text{ mA}$		MAX	35	mA
I_L	$I_G = 1.2 \times I_{GT}$	I - III	MAX	50	mA
		II	MAX	80	
dV/dt ⁽²⁾	$V_D = 67\% V_{DRM}$, gate open, $T_j = 125\text{ °C}$		MIN	750	V/ μ s
(dI/dt) _c ⁽²⁾	Without snubber, $T_j = 125\text{ °C}$		MIN	5.3	A/ms
V_{ins}	Insulation rms voltage, 1 minute			2.0	kV

1. Minimum I_{GT} is guaranteed at 5% of I_{GT} max.
2. For both polarities of A2 pin referenced to A1 pin

Table 3. Static electrical characteristics

Symbol	Test conditions			Value	Unit
$V_{TM}^{(1)}$	$I_{TM} = 5.7 \text{ A}$, $t_p = 380 \mu\text{s}$	$T_j = 25 \text{ }^\circ\text{C}$	MAX	1.6	V
$V_{TO}^{(1)}$	Threshold voltage	$T_j = 125 \text{ }^\circ\text{C}$	MAX	0.9	V
$R_D^{(1)}$	Dynamic resistance	$T_j = 125 \text{ }^\circ\text{C}$	MAX	100	m Ω
I_{DRM} I_{RRM}	$V_{DRM} = V_{RRM}$	$T_j = 25 \text{ }^\circ\text{C}$	MAX	5	μA
		$T_j = 125 \text{ }^\circ\text{C}$		1	mA

1. For both polarities of A2 pin referenced to A1 pin

Table 4. Thermal resistances

Symbol	Parameter	Value	Unit
$R_{th(j-c)}$	Junction to case (ac)	4.3	$^\circ\text{C/W}$
$R_{th(j-a)}$	Junction to ambient	60	

Figure 1. Maximum power dissipation versus rms on-state current (full cycle)

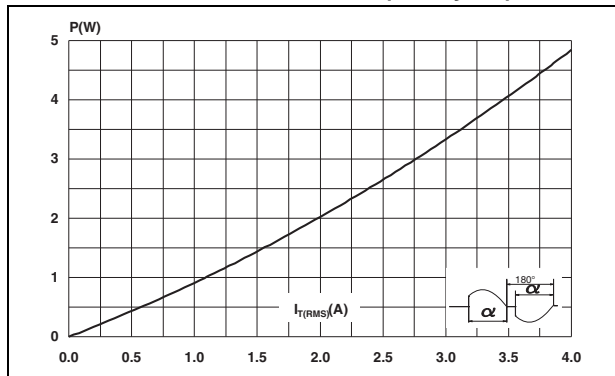

Figure 2. On-state current (rms) versus case temperature (full cycle)

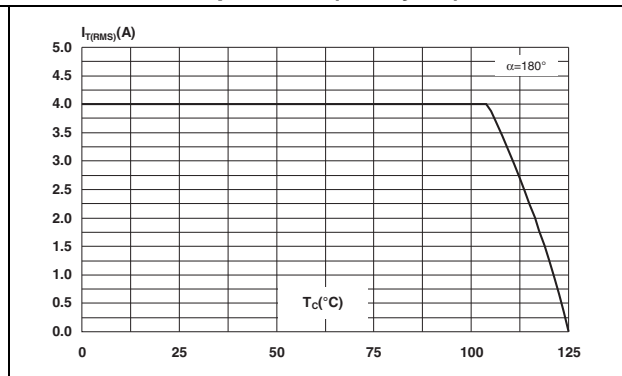

Figure 3. On-state current (rms) versus ambient temperature (free air convection)

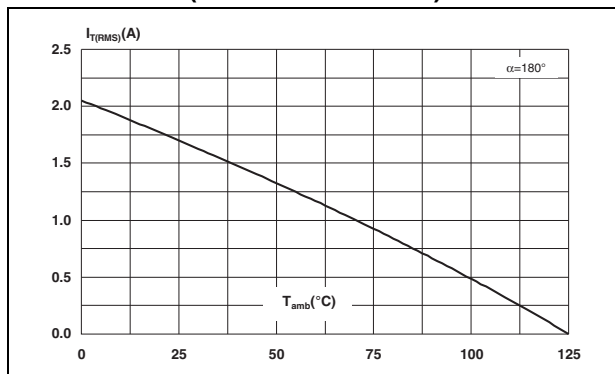

Figure 4. Relative variation of thermal impedance versus pulse duration

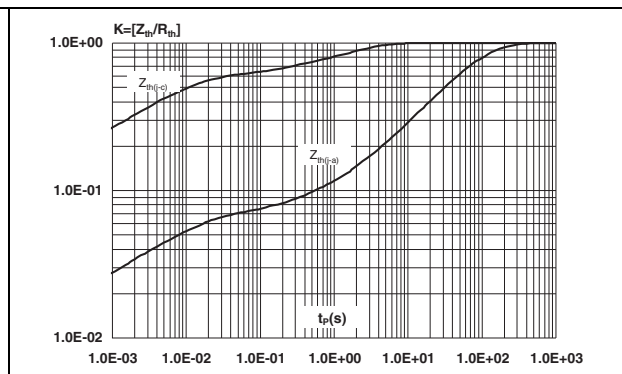

Figure 5. Relative variation of gate trigger current, and gate trigger voltage versus junction temperature

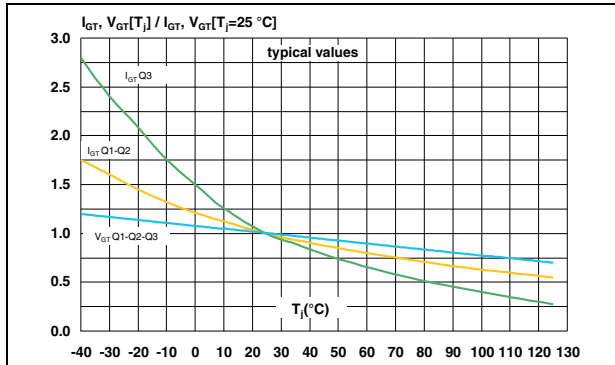

Figure 6. Relative variation of holding current and latching current versus junction temperature

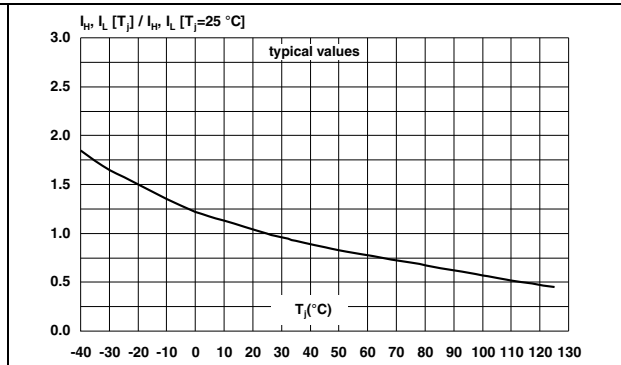

Figure 7. Surge peak on-state current versus number of cycles

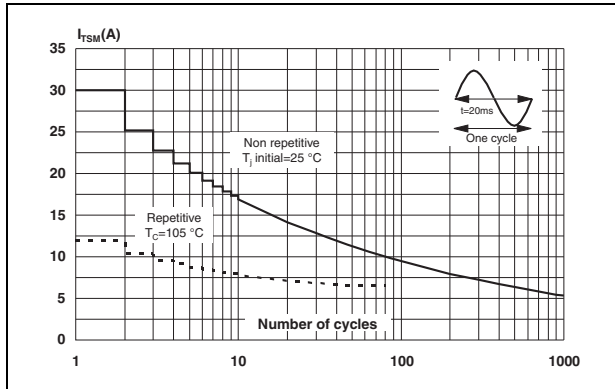

Figure 8. Non-repetitive surge peak on-state current for a sinusoidal

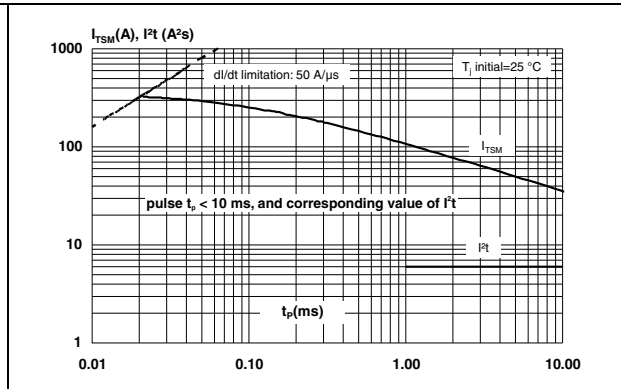

Figure 9. On-state characteristics (maximum values)

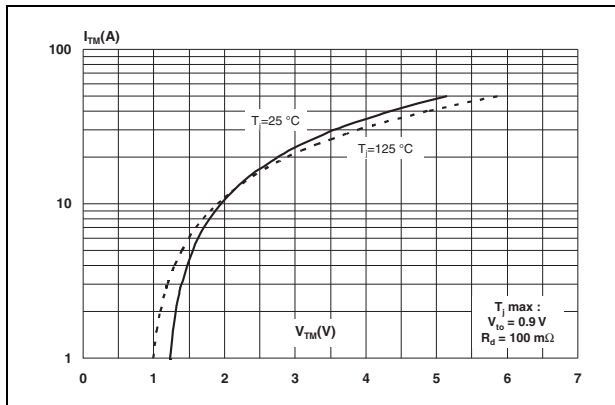

Figure 10. Relative variation of critical rate of decrease of main current (di/dt)c versus junction temperature

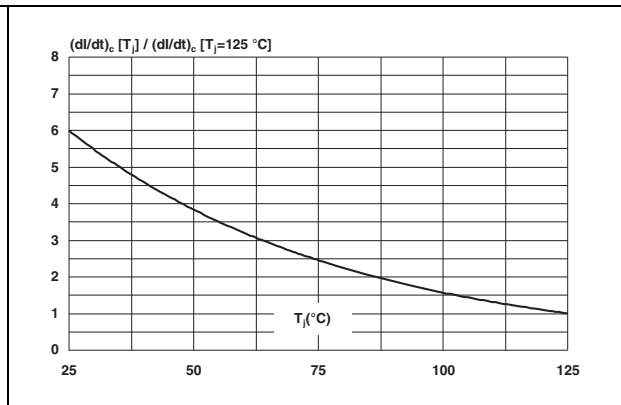

Figure 11. Relative variation of critical rate of decrease of main current (di/dt)_c versus reapplied (dV/dt)_c

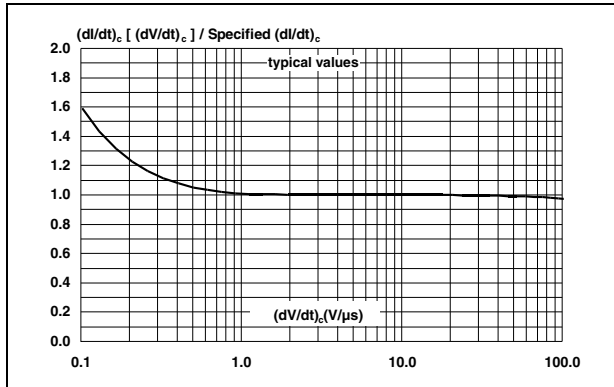
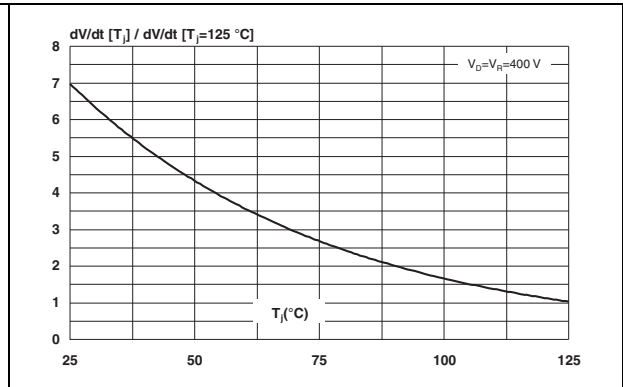

Figure 12. Relative variation of static dV/dt immunity versus junction temperature



2 Package information

- Epoxy meets UL94, V0
- Lead-free packages

In order to meet environmental requirements, ST offers these devices in different grades of ECOPACK® packages, depending on their level of environmental compliance. ECOPACK® specifications, grade definitions and product status are available at: www.st.com. ECOPACK® is an ST trademark.

Figure 13. TO-220FPAB dimension definitions

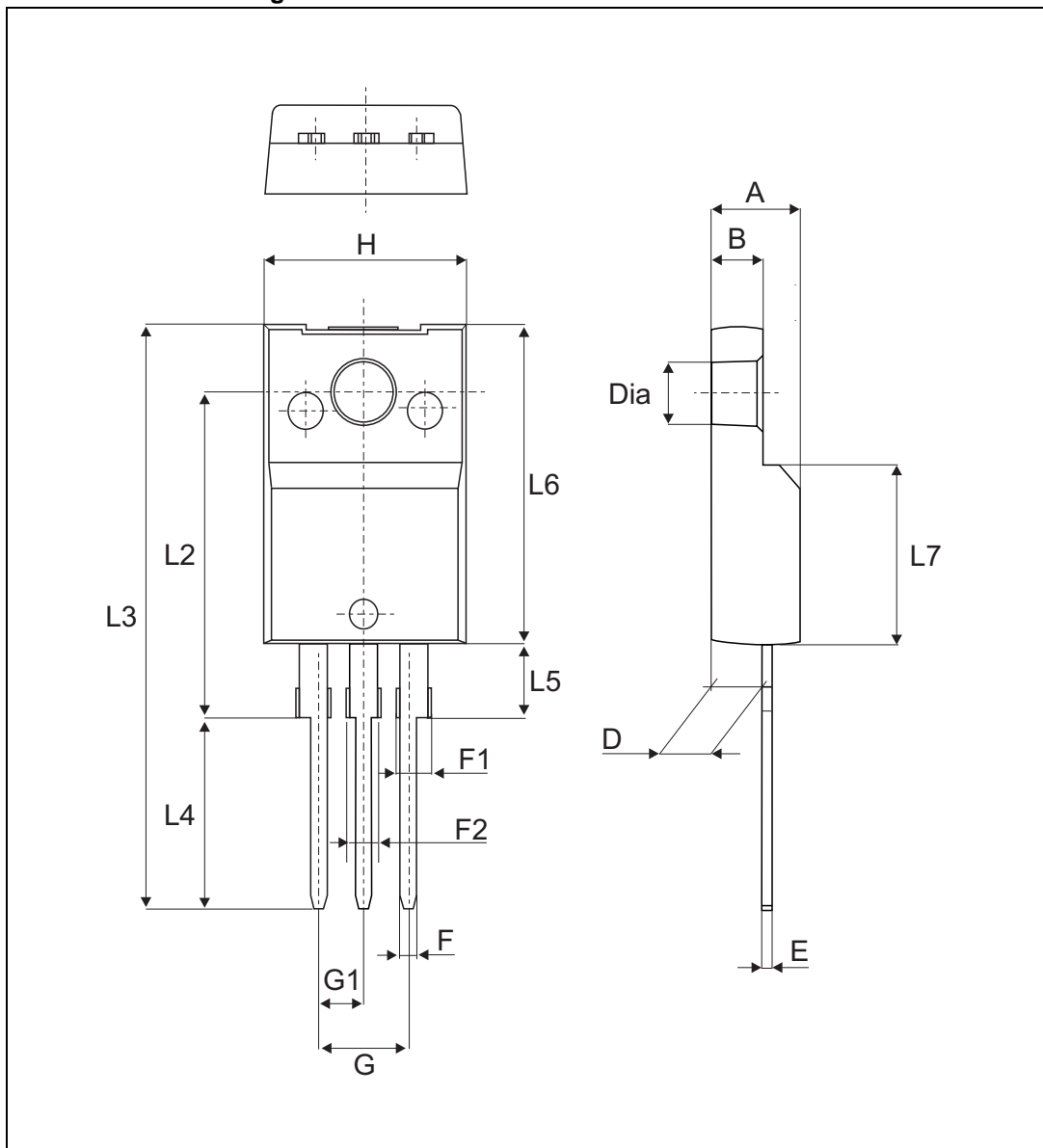

Table 5. TO-220FPAB dimension values

Ref.	Dimensions					
	Millimeters			Inches		
	Min.		Max.	Min.		Max.
A	4.4		4.6	0.173		0.181
B	2.5		2.7	0.098		0.106
D	2.5		2.75	0.098		0.108
E	0.45		0.70	0.018		0.027
F	0.75		1	0.030		0.039
F1	1.15		1.70	0.045		0.067
F2	1.15		1.70	0.045		0.067
G	4.95		5.20	0.195		0.205
G1	2.4		2.7	0.094		0.106
H	10		10.4	0.393		0.409
L2		16 Typ.			0.63 Typ.	
L3	28.6		30.6	1.126		1.205
L4	9.8		10.6	0.386		0.417
L5	2.9		3.6	0.114		0.142
L6	15.9		16.4	0.626		0.646
L7	9.00		9.30	0.354		0.366
Dia.	3.00		3.20	0.118		0.126

3 Ordering information

Figure 14. Ordering information scheme

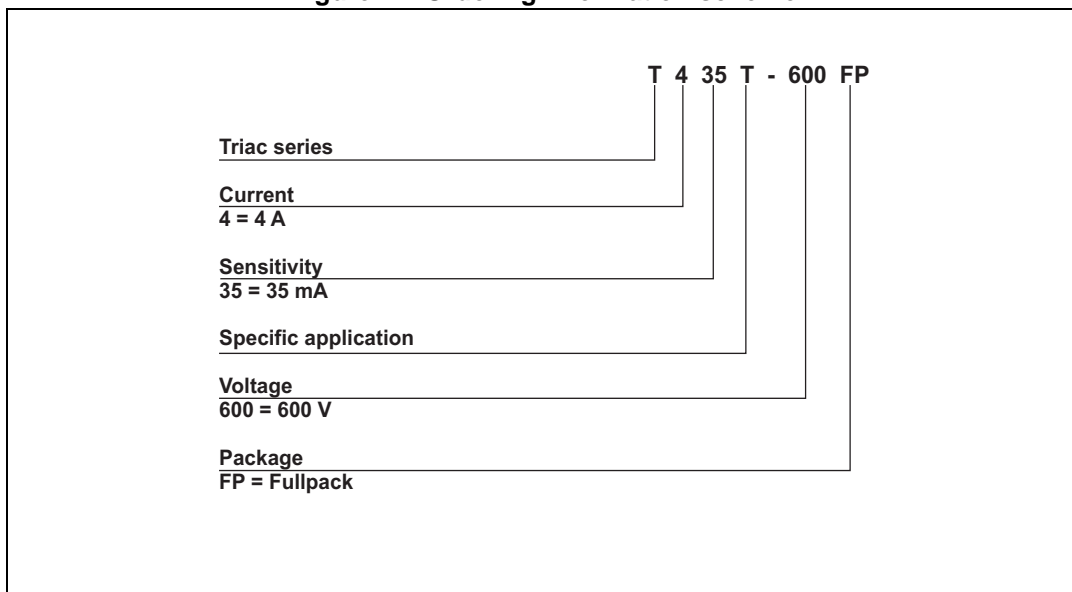

Table 6. Ordering information

Order code	Marking	Package	Weight	Base qty	Packing mode
T435T-600FP	T435T-600	TO-220FPAB	2.0 g	50	Tube

4 Revision history

Table 7. Document revision history

Date	Revision	Changes
09-Nov-2007	1	Initial release.
14-Jun-2010	2	Updated ECOPACK statement.
28-Jul-2014	3	Updated Features , Table 2 and Figure 14 and reformatted to current standard.

IMPORTANT NOTICE – PLEASE READ CAREFULLY

STMicroelectronics NV and its subsidiaries ("ST") reserve the right to make changes, corrections, enhancements, modifications, and improvements to ST products and/or to this document at any time without notice. Purchasers should obtain the latest relevant information on ST products before placing orders. ST products are sold pursuant to ST's terms and conditions of sale in place at the time of order acknowledgement.

Purchasers are solely responsible for the choice, selection, and use of ST products and ST assumes no liability for application assistance or the design of Purchasers' products.

No license, express or implied, to any intellectual property right is granted by ST herein.

Resale of ST products with provisions different from the information set forth herein shall void any warranty granted by ST for such product.

ST and the ST logo are trademarks of ST. All other product or service names are the property of their respective owners.

Information in this document supersedes and replaces information previously supplied in any prior versions of this document.

© 2014 STMicroelectronics – All rights reserved



Mouser Electronics

Authorized Distributor

Click to View Pricing, Inventory, Delivery & Lifecycle Information:

[STMicroelectronics:](#)

[T435T-600FP](#)