

Product Overview

The QPA9154 is a 50Ω single-ended input to 100Ω differential output, wideband gain block. It is well suited as the 5G m-MIMO BTS Rx path final gain stage, to directly interface with the ADC of the transceiver, eliminating the need for a discrete balun.

This amplifier delivers exceptional performance with 19 dB of small signal gain and 35 dBm output 3rd order intercept (OIP3). The amplifier has excellent gain flatness of 0.5 dB over any 400 MHz bandwidth and a CMRR of 35 dB. The amplifier features a shut-down function through V_{PD} pin control.

The QPA9154 is optimized over 2.3-3.8 GHz band and is housed in a compact 2 x 2 mm SMT package.



12-pin, 2 x 2 mm SMT Package

Key Features

- 2.3–3.8 GHz Operational Frequency
- 100 Ohm Differential Output
- 50 Ohm Single-Ended Input
- 19 dB Gain at 2.6 GHz
- +34 dBm OIP3
- +18.5 dBm P1dB
- Small 2 x 2 mm SMT Package

Functional Block Diagram

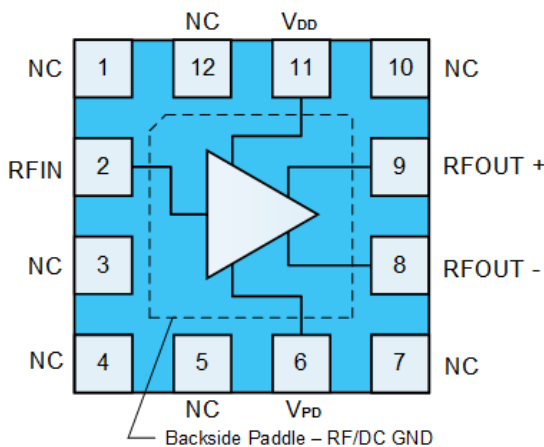

Top View

Applications

- 5G m-MIMO
- Mobile Infrastructure
- General Purpose Wireless
- TDD / FDD System

Ordering Information

Part No.	Description
QPA9154TR7	2500 pcs on 7" reel (standard)
QPA9154EVB-01	Differential Output Evaluation Board

Absolute Maximum Ratings

Parameter	Rating
Storage Temperature	-65 to +150°C
RF Input Power, CW, 50 Ω, T=25 °C	22 dBm
Device Voltage (V _{DD})	7 V

Exceeding any one or a combination of the Absolute Maximum Rating conditions may cause permanent damage to the device. Extended application of Absolute Maximum Rating conditions to the device may reduce device reliability.

Recommended Operating Conditions

Parameter	Min	Typ	Max	Units
Device Voltage (V _{DD})	+3.3	+5	+5.25	V
T _{CASE}	-40		+105	°C
T _j for >10 ⁶ hours MTTF			+190	°C

Electrical specifications are measured at specified test conditions. Specifications are not guaranteed over all recommended operating conditions.

Electrical Specifications

Parameter	Conditions ⁽¹⁾	Min	Typ	Max	Units
Operational Frequency Range		2300		3800	MHz
Test Frequency			2600		MHz
Small Signal Gain		16.5	19	20.5	dB
Gain Flatness	Any 400 MHz BW		0.5		dB
CMRR			35		dB
Input Return Loss			13		dB
Output Return Loss	100 Ω differential		17		dB
Output P1dB		+16	+19		dBm
Output IP3	P _{out} 0 dBm/tone combined, Δf = 1 MHz	+29	+34		dBm
Differential Output Impedance			100		ohm
Noise Figure			1.5		dB
Device Current, ON	V _{PD} = 0.63 V		70	110	mA
Device Current, OFF	V _{PD} = 1.17 V		4		mA
V _{PD} , Logic Low		0		0.63	V
V _{PD} , Logic High		1.17		V _{DD}	V
Switching Time	50% V _{PD} to 10/90% RF		100		nsec
Thermal Resistance, θ _{jc}	Junction to case		50		°C/W

Notes:

1. Test conditions unless otherwise noted: V_{DD} +5.0 V, V_{PD} +0.63 V, Temp +25 °C, 50 Ω system. Differential output conversion with ideal balun

Logic Table

Parameter, V _{PD}	High	Low
Device State	OFF	ON

2300 to 3800MHz Differential Evaluation Board - QPA9154EVB-01

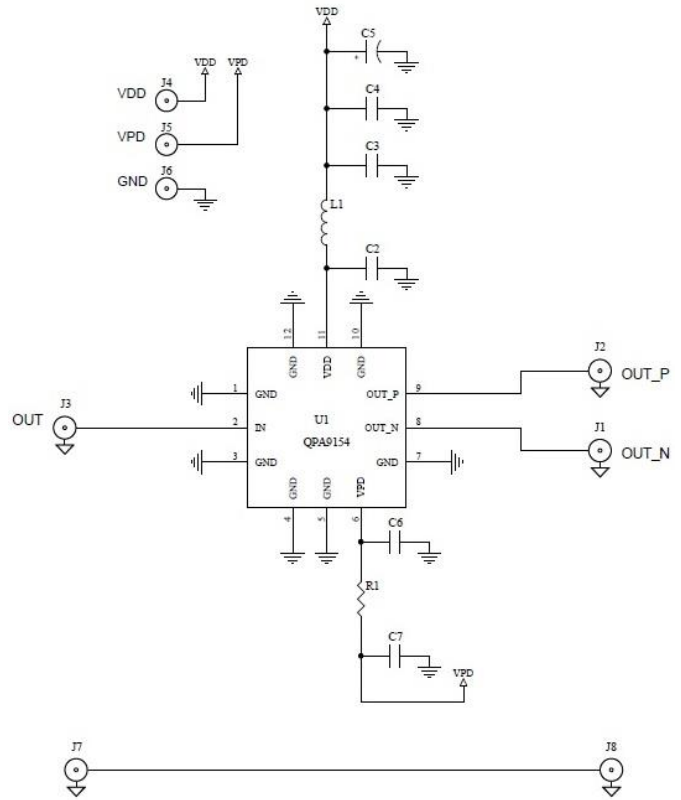
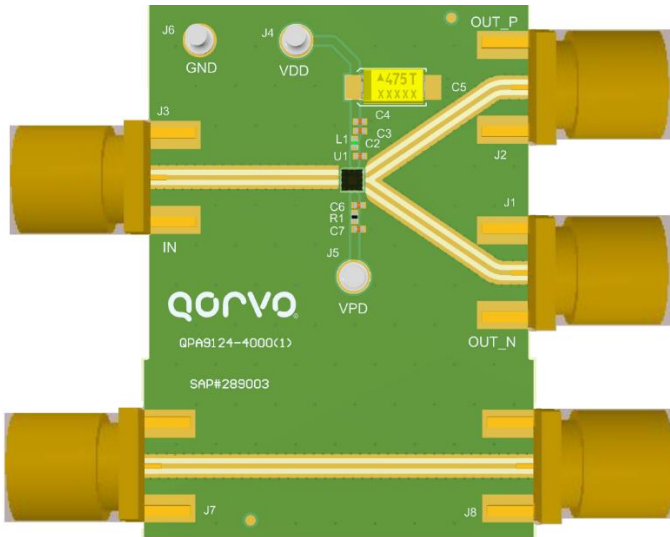

Bill of Materials

Reference Des.	Value	Description	Manuf.	Part Number
-	-	Printed Circuit Board	Qorvo	
U1	-	Differential Output Rx Gain Block	Qorvo	QPA9154
C5	10 μF	CAP, 10 μF, 20%, 25V, Tantalum, 6032	Cal-Chip	TCMIE106CT
C3	1000 pF	CAP, 1000 pF, 10%, 50V, X7R, 0402	Various	
C4	0.1 μF	CAP, 0.1 μF, 10%, 50V, X5R, 0402	Various	
R1	0 Ω	RES, 0 Ω, 1/10W, 0402	Various	
L1 ⁽¹⁾	3.9 nH	IND, 3.9 nH, Thin Film, 0402	Various	
J1, J2, J3	-	Conn, SMA F STRT .062"	Cinch Connectivity	142-0701-851

Notes:

1. For optimum performance replace L1 with 6.8 nH inductor for 2.3GHz to 2.7GHz band, or 2.0 nH for 3.3GHz to 3.8GHz band.

2300 to 3800MHz Evaluation Board with Output Balun

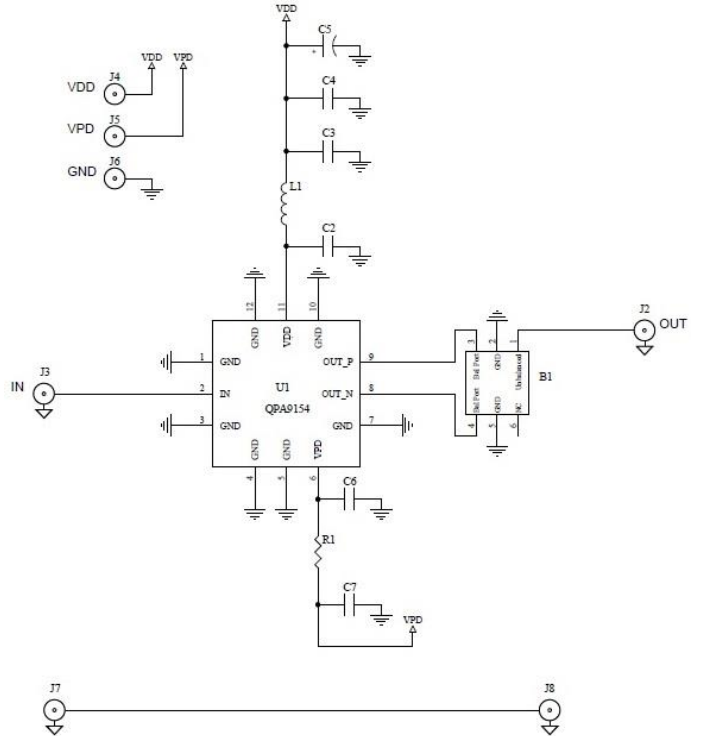

Bill of Materials

Reference Des.	Value	Description	Manuf.	Part Number
-	-	Printed Circuit Board	Qorvo	
U1	-	Differential Output Rx Gain Block	Qorvo	QPA9154
B1	-	BALUN, 3.1GHZ-5GHZ, 50/100, 0404	Anaren	BD3150N50100AHF
C5	10 μF	CAP, 10 μF, 20%, 25V, Tantalum, 6032	Cal-Chip	TCMIE106CT
C3	1000 pF	CAP, 1000 pF, 10%, 50V, X7R, 0402	Various	
C4	0.1 μF	CAP, 0.1 μF, 10%, 50V, X5R, 0402	Various	
R1	0 Ω	RES, 0 Ω, 1/10W, 0402	Various	
L1 ⁽¹⁾	3.9 nH	IND, 3.9 nH, Thin Film, 0402	Various	
J1, J2, J3	-	Conn, SMA F STRT .062"	Cinch Connectivity	142-0701-851

Notes:

1. For optimum performance replace L1 with 6.8 nH inductor for 2.3GHz to 2.7GHz band, or 2.0 nH for 3.3GHz to 3.8GHz band.

Typical Performance – QPA9154EVB-01

Parameter	Conditions ⁽¹⁾	Typical Value						Units
		2300	2600	2700	3200	3600	3800	
Frequency		2300	2600	2700	3200	3600	3800	MHz
Gain		18.6	19.1	19.1	19.8	20.0	19.1	dB
Input Return Loss		12.5	14.1	13.8	12.7	16.7	20.2	dB
Output Return Loss	100 Ω differential	7.5	12.9	16.2	13.1	8.1	7.2	dB
Output P1dB		18.7	18.4	18.2	18.1	17.3	16.9	dBm
Output IP3	Pout 0 dBm/tone combined, Δf 1 MHz	36.1	35.0	36.3	34.7	32.7	31.3	dBm
Device Current	V _{DD}	70						mA

Notes:

 1. Test Conditions unless otherwise noted: V_{DD} = +5.0 V, V_{PD} = +0.63 V, Temp. +25 °C. L1 3.9 nH. Differential output conversion with ideal balun

Performance Plots – QPA9154EVB-01

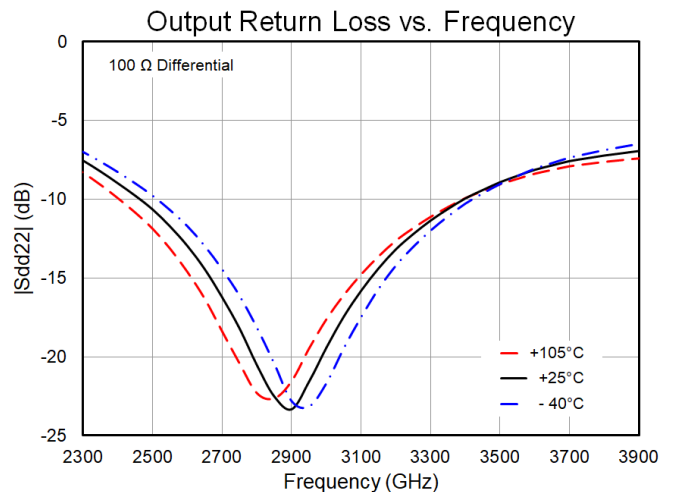
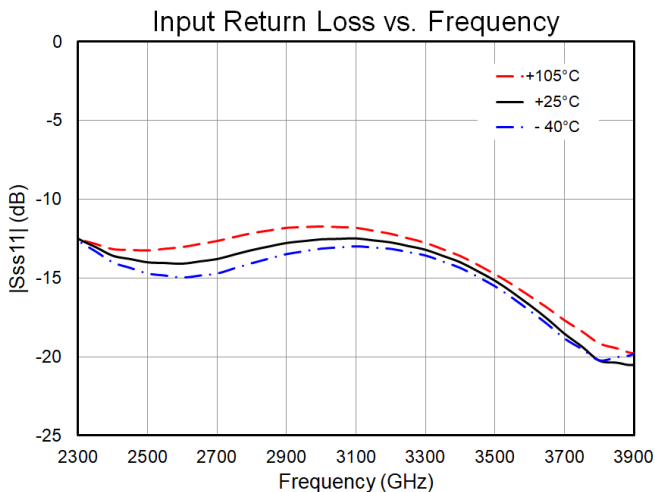
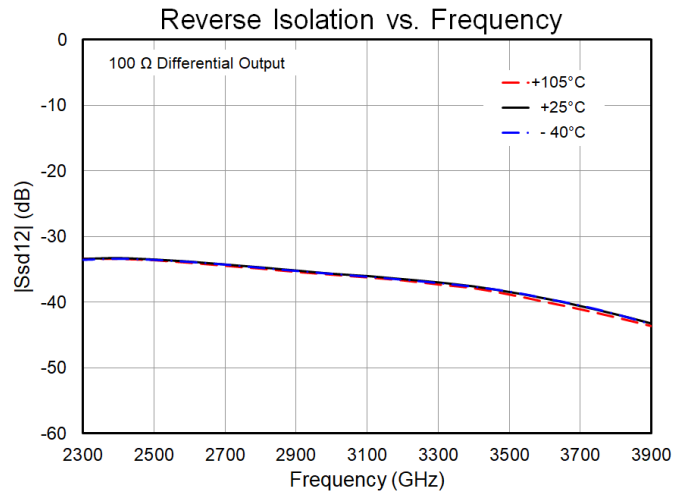
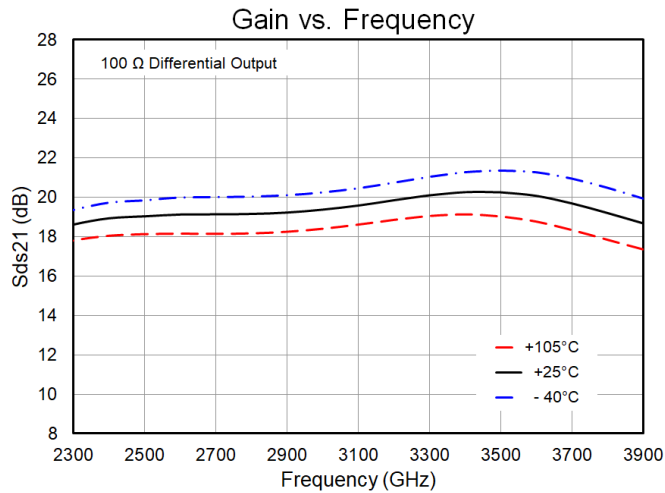
 Test conditions unless otherwise noted: V_{DD} = +5.0 V, I_{DD} = 70 mA, V_{PD} = +0.63 V, 50 Ω system

Performance Plots – QPA9154EVB-01 (Continue)

Test conditions unless otherwise noted: $V_{DD} = +5.0\text{ V}$, $I_{DD} = 70\text{ mA}$, $V_{PD} = +0.63\text{ V}$, 50 Ω system

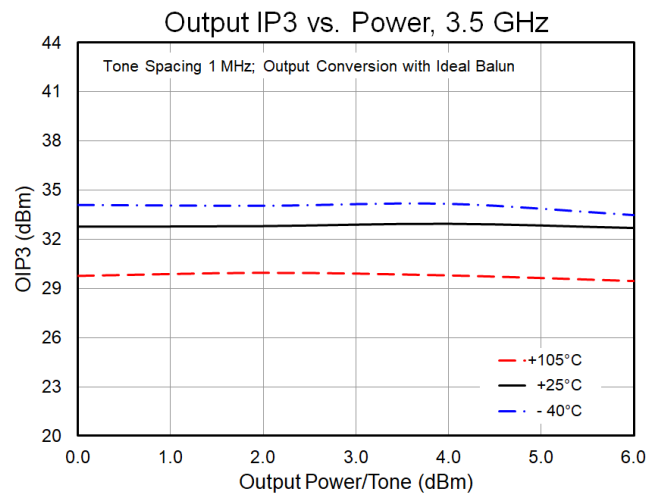
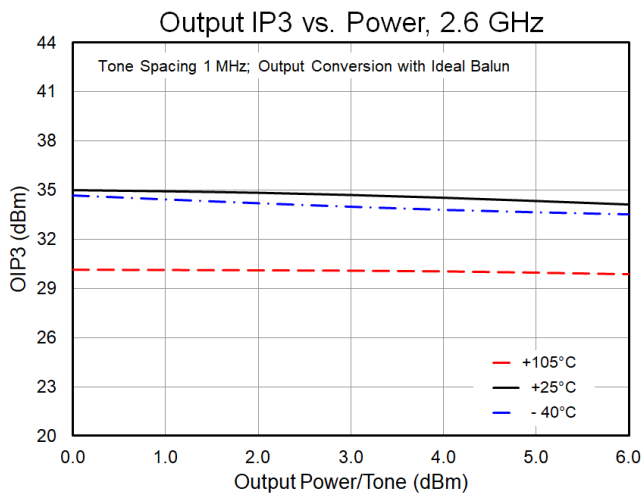
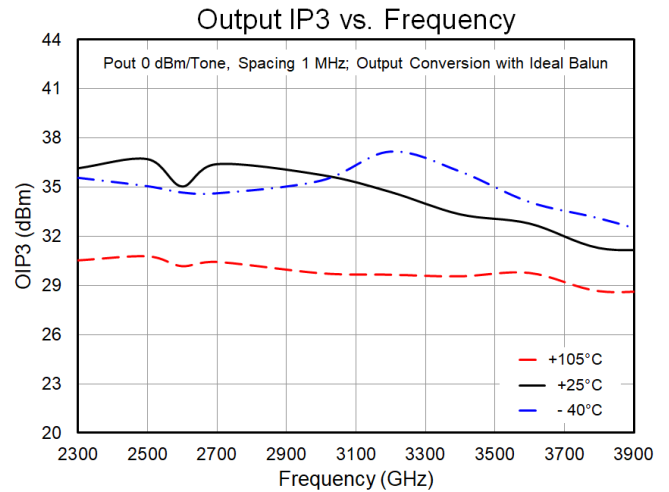
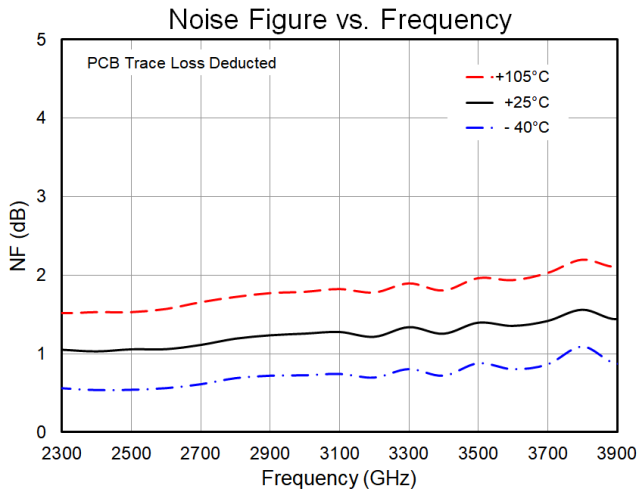
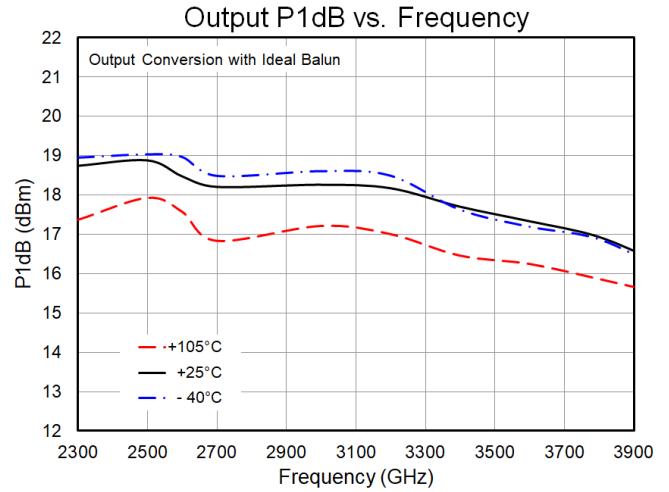
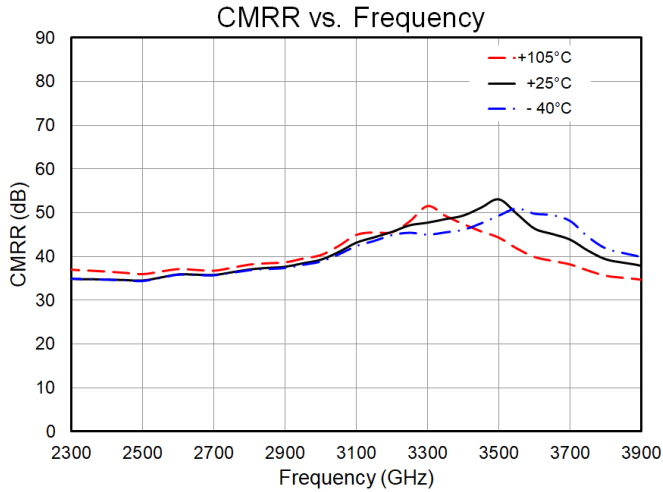

Typical Performance – EVB with L1 6.8 nH for 2.3-2.7 GHz

Parameter	Conditions (1)	Typical Value			Units
Frequency		2300	2600	2700	MHz
Gain		19.3	19.9	20.0	dB
Input Return Loss		14.1	13.0	12.3	dB
Output Return Loss	100 Ω differential	9.6	17.6	18.3	dB
Output P1dB		18.9	18.9	18.9	dBm
Output IP3	Pout 0 dBm/tone combined, Δf 1 MHz	35.5	34.9	35.8	dBm
Device Current	V _{DD}	70			mA

Notes:
 1. Test Conditions unless otherwise noted: V_{DD} +5.0 V, V_{PD} +0.63 V, Temp. +25 °C. L1 = 6.8nH. Differential output conversion with ideal balun

Performance Plots – EVB with L1 6.8 nH for 2.3-2.7 GHz

Test conditions unless otherwise noted: V_{DD} = +5.0 V, I_{DD} = 70 mA, V_{PD} = +0.63 V, 50 Ω system

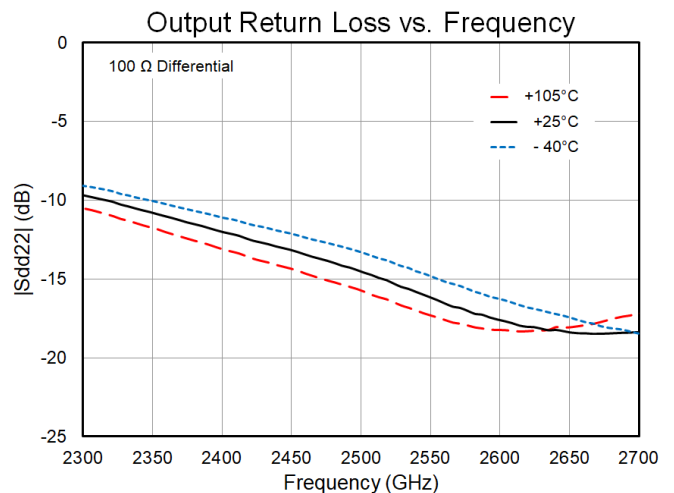
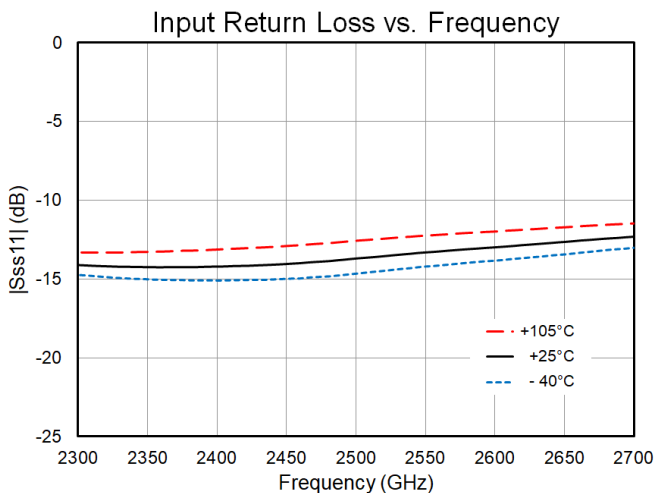
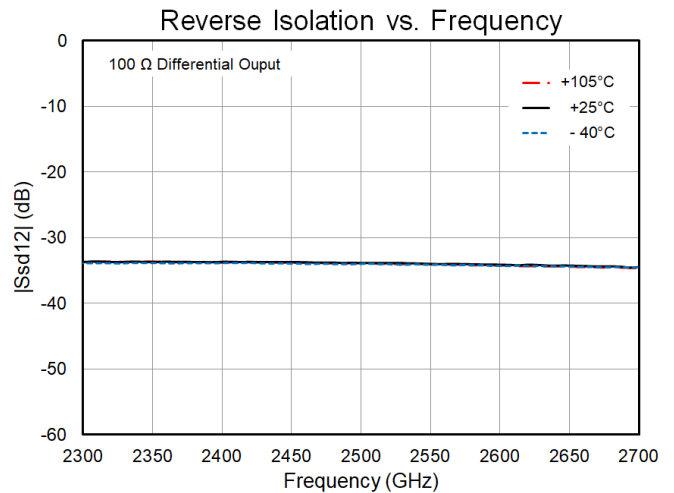
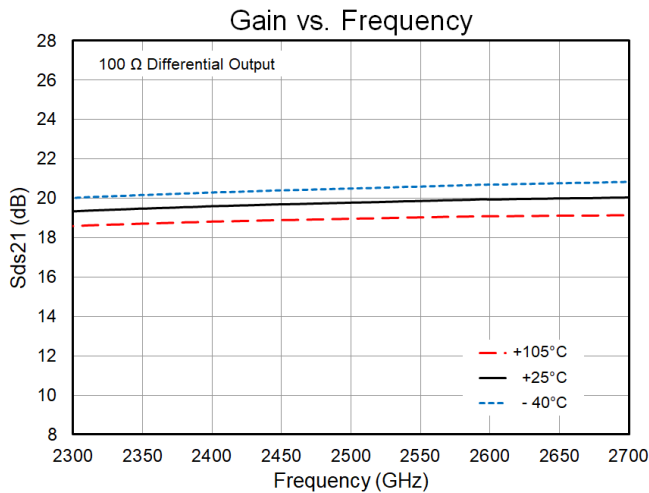

Performance Plots – EVB with L1 6.8 nH for 2.3-2.7 GHz (Continue)

Test conditions unless otherwise noted: $V_{DD} = +5.0\text{ V}$, $I_{DD} = 70\text{ mA}$, $V_{PD} = +0.63\text{ V}$, 50Ω system

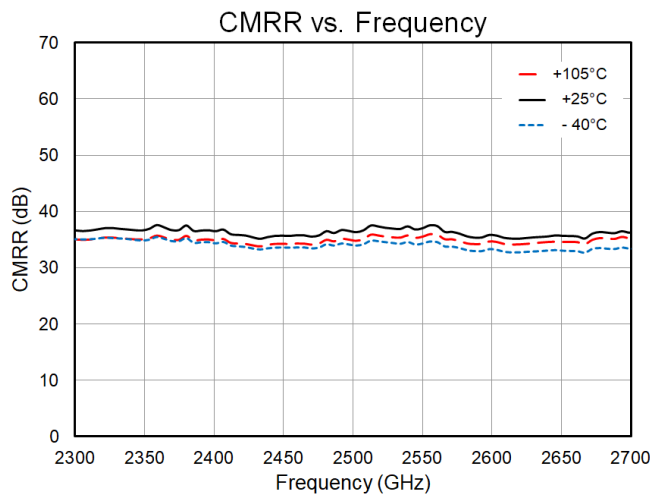
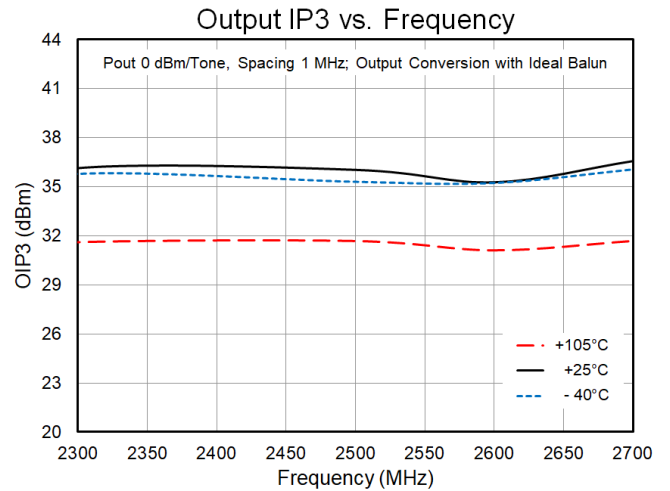
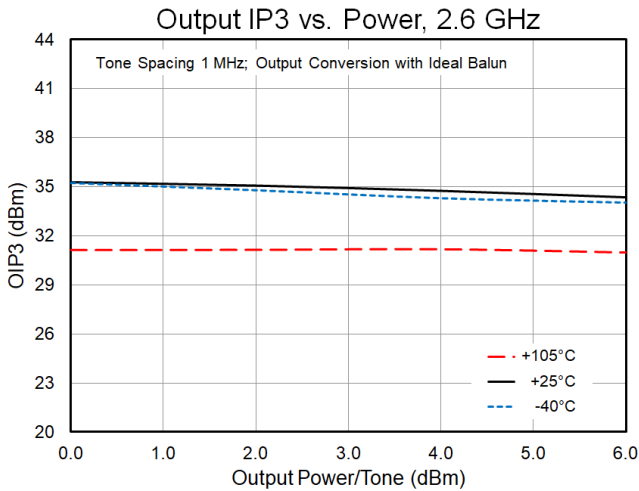
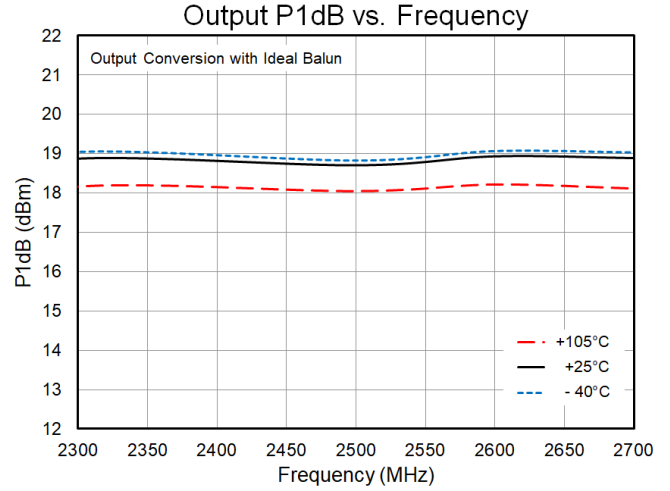
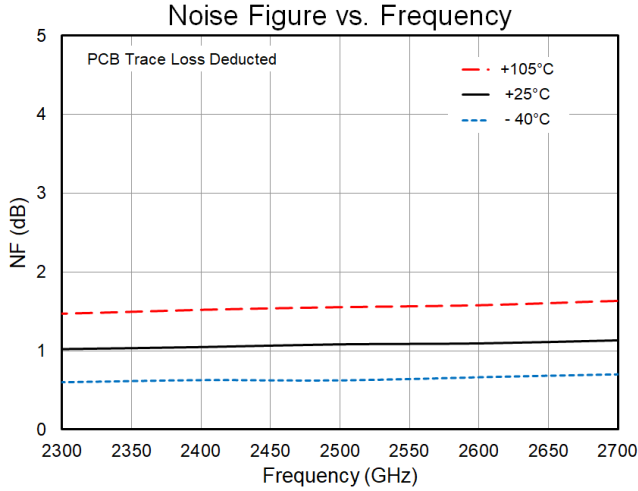

Typical Performance – EVB with L1 2.0 nH for 3.3-3.8 GHz

Parameter	Conditions ⁽¹⁾	Typical Value			Units
		3200	3500	3800	
Frequency		3200	3500	3800	MHz
Gain		20.5	20.9	20.9	dB
Input Return Loss		15.7	16.6	19.7	dB
Output Return Loss	100 Ω differential	27.2	12.9	7.8	dB
Output P1dB		18.5	19.1	18.6	dBm
Output IP3	Pout 0 dBm/tone combined, Δf 1 MHz	34.9	36.1	35.4	dBm
Device Current	V _{DD}	70			mA

Notes:

1. Test Conditions unless otherwise noted: V_{DD} +5.0V, V_{PD} +0.63 V, Temp. +25 °C, L1 2.0 nH. Differential output conversion with ideal balun

Performance Plots – EVB with L1 2.0 nH for 3.3-3.8 GHz

Test conditions unless otherwise noted: V_{DD} = +5.0V, I_{DD} = 70 mA, V_{PD} = +0.63 V, 50 Ω system

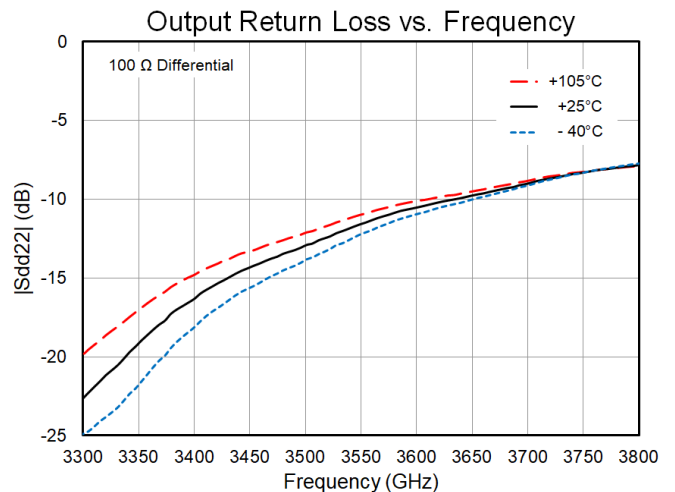
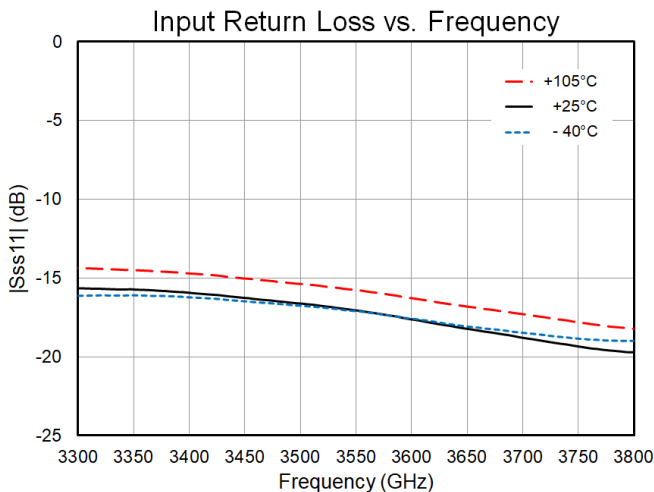
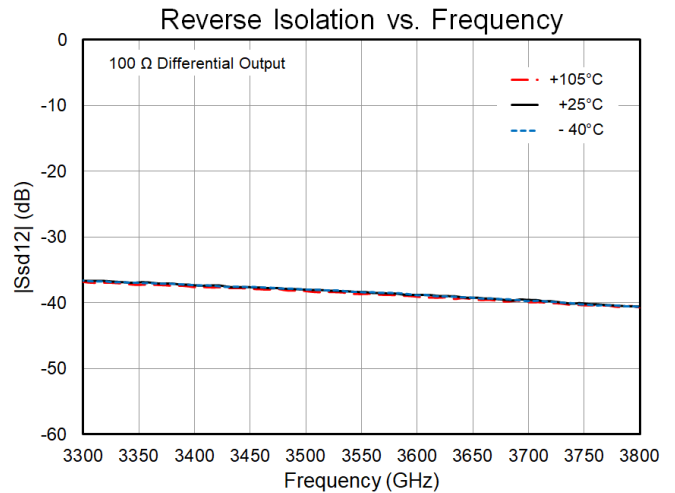
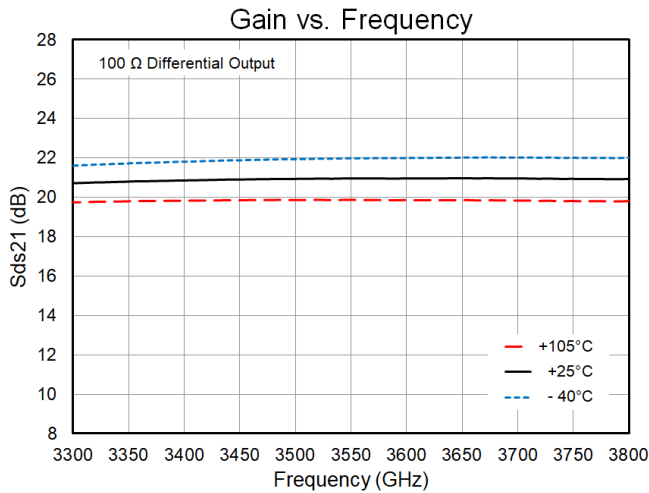

Performance Plots – EVB with L1 2.0 nH for 3.3-3.8 GHz (Continue)

Test conditions unless otherwise noted: $V_{DD} = +5.0V$, $I_{DD} = 70\text{ mA}$, $V_{PD} = +0.63V$, 50Ω system

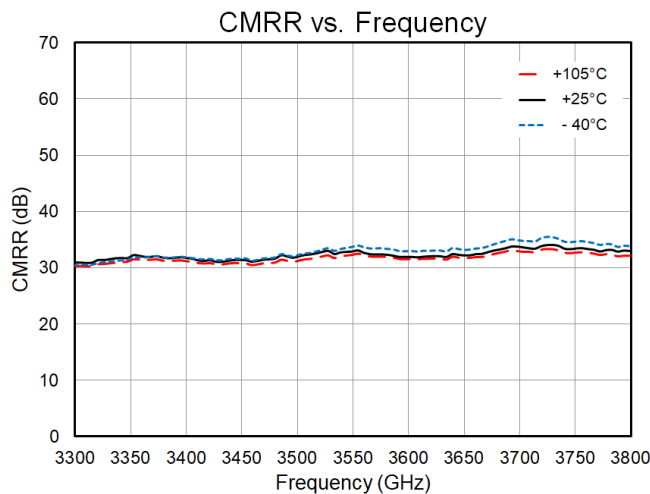
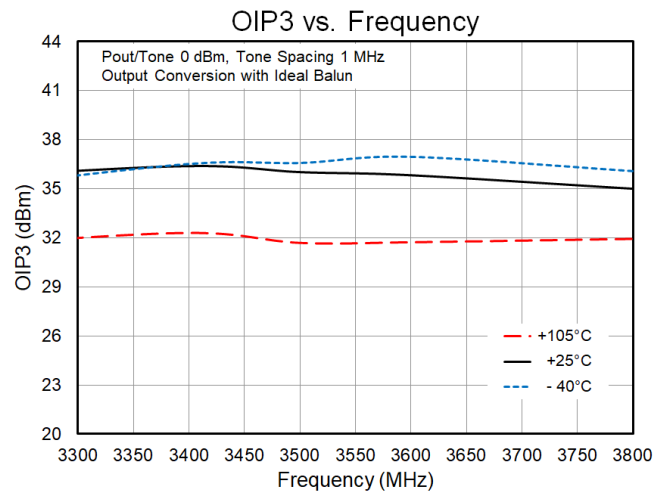
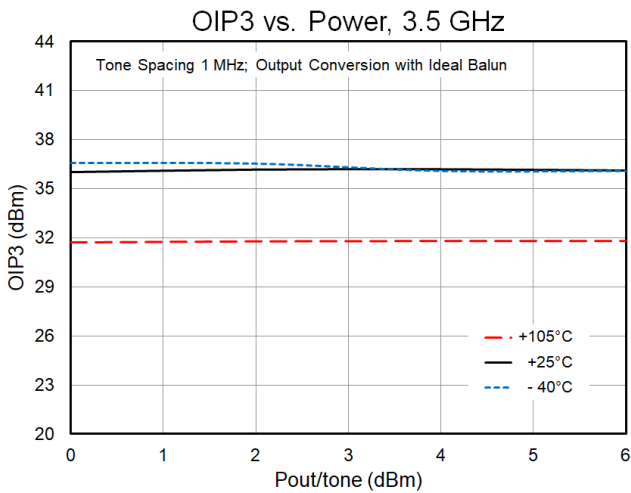
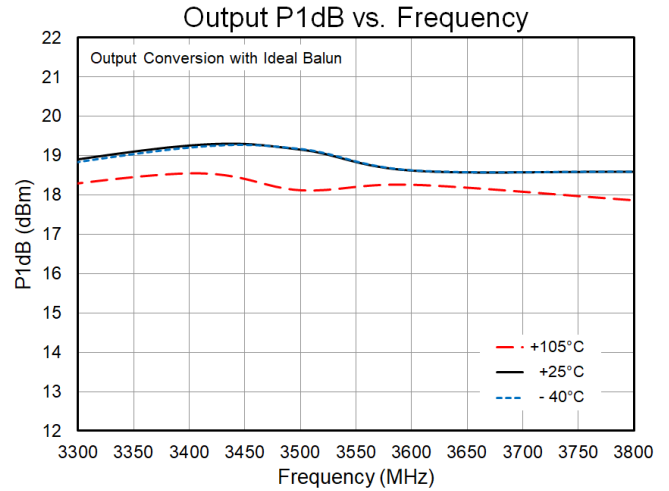
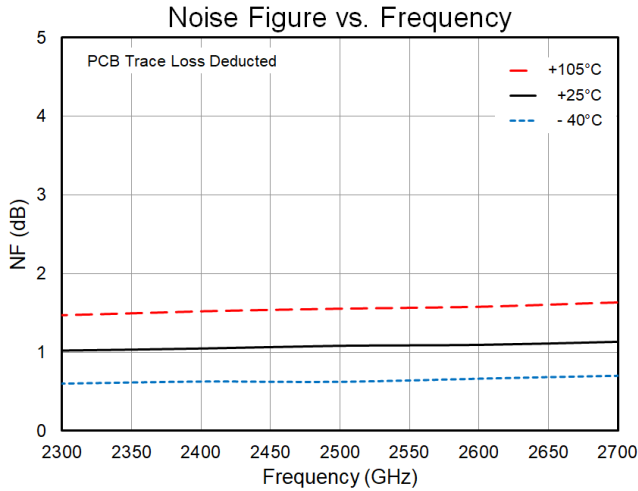

Pad Configuration and Description

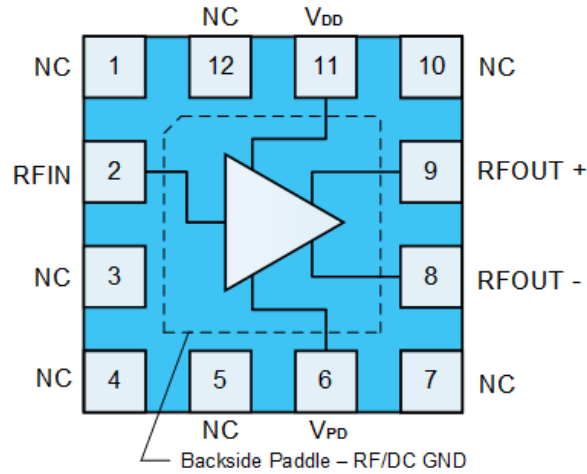

Top View

Pad No.	Label	Description
1, 3, 4, 5, 7, 10, 12	NC	No electrical connection internally. It may be left floating or connected to ground. Land pads should be provided for PCB mounting integrity.
2	RFIN	RF input. Internally matched to 50Ω.
6	VPD	Power down control input, Turn down amplifier bias.
8	RFOUT-	Differential output -. Requires external DC blocking capacitor if DC is present on this pin.
9	RFOUT+	Differential output +. Requires external DC blocking capacitor if DC is present on this pin.
11	VDD	DC Power input, supply voltage for amplifier.
Backside Paddle	GND	RF/DC ground. Use recommended via hole pattern to minimize inductance and thermal resistance. See PCB Mounting Pattern for suggested footprint.

Tape and Reel Information – Carrier and Cover Tape Dimensions

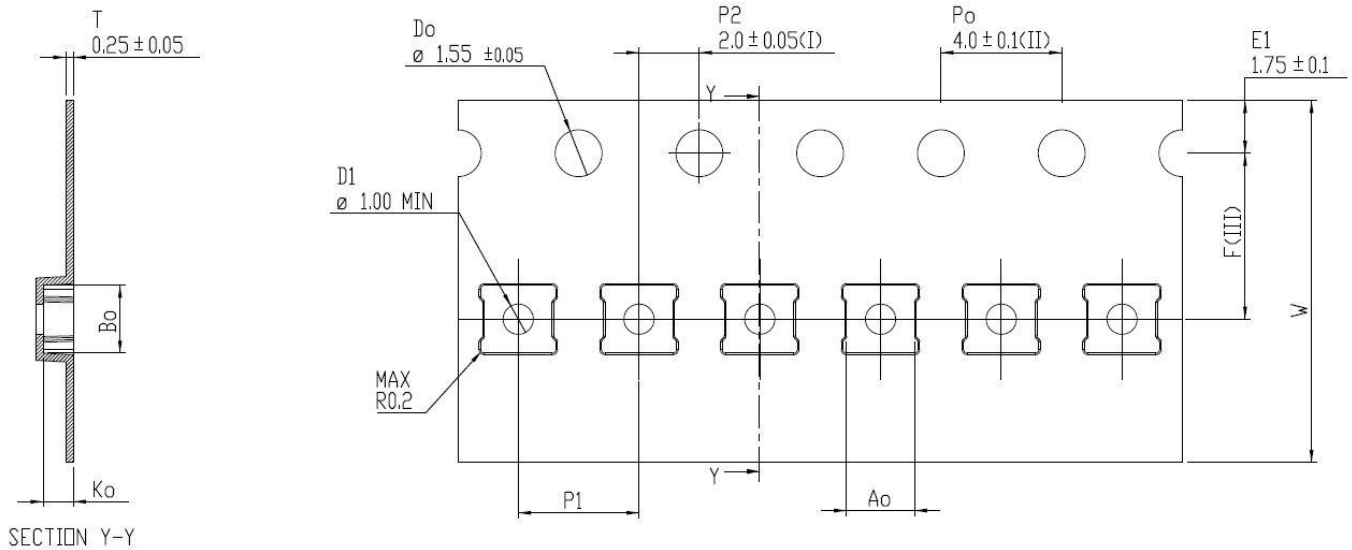

Feature	Measure	Symbol	Size (in)	Size (mm)
Cavity	Length	A0	0.087	2.20
	Width	B0	0.087	2.20
	Depth	K0	0.037	0.95
	Pitch	P1	0.157	4.00
Centerline Distance	Cavity to Perforation - Length Direction	P2	0.079	2.00
	Cavity to Perforation - Width Direction	F	0.217	5.50
Cover Tape	Width	C	0.362	9.20
Carrier Tape	Width	W	0.472	12.00

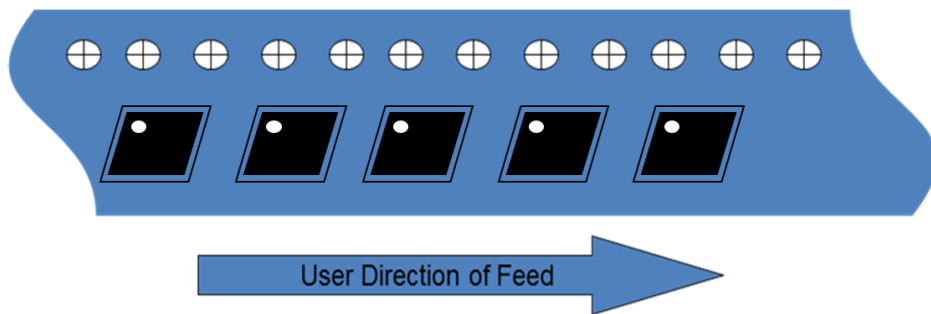

Tape and Reel Information – Reel Dimensions

Standard T/R size = 2,500 pieces on a 7" reel.

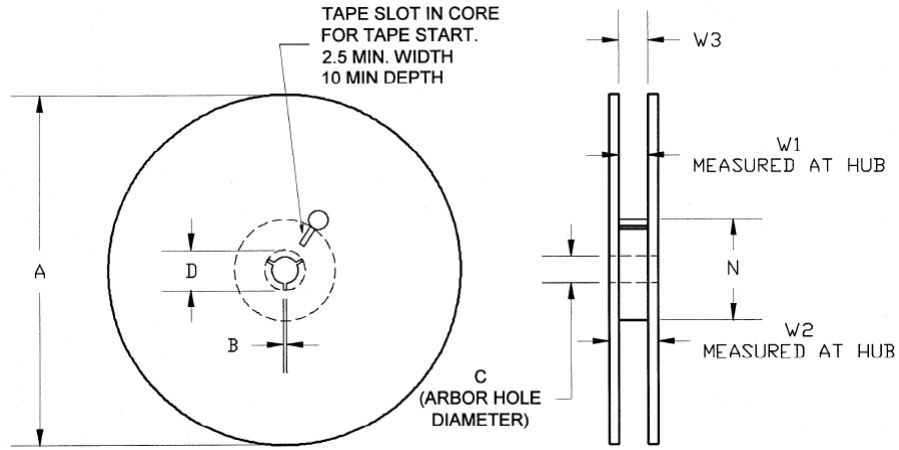

Feature	Measure	Symbol	Size (in)	Size (mm)
Flange	Diameter	A	6.969	177.0
	Thickness	W2	0.717	18.2
	Space Between Flange	W1	0.504	12.8
Hub	Outer Diameter	N	2.283	58.0
	Arbor Hole Diameter	C	0.512	13.0
	Key Slit Width	B	0.079	2.0
	Key Slit Diameter	D	0.787	20.0

Tape and Reel Information – Tape Length and Label Placement

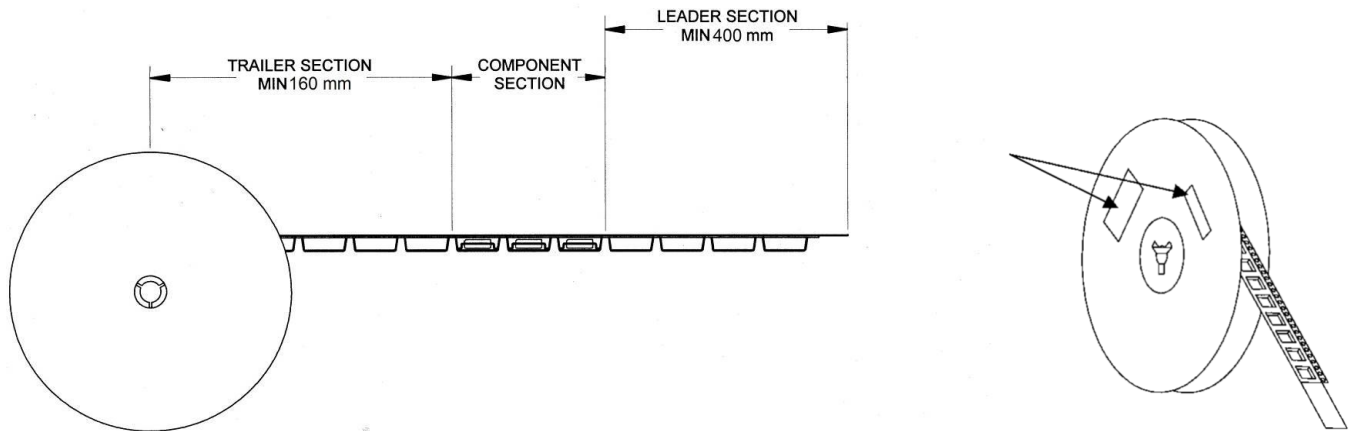

Notes:

1. Empty part cavities at the trailing and leading ends are sealed with cover tape. See EIA 481-1-A.
2. Labels are placed on the flange opposite the sprockets in the carrier tape.

Handling Precautions

Parameter	Rating	Standard
ESD – Human Body Model (HBM)	Class 1C	ESDA / JEDEC JS-001-2017
ESD – Charged Device Model (CDM)	Class C3	JEDEC JESD22-C101F
MSL – Moisture Sensitivity Level	Level 3	IPC/JEDEC J-STD-020E



Caution!
ESD-Sensitive Device

Solderability

Compatible with both lead-free (260°C max. reflow temperature) and tin/lead (245°C max. reflow temperature) soldering processes. Solder profiles available upon request.

Contact plating: ENEPIG (*Ni 0.40 ± 0.10 μm, Pd 0.145 ± 0.035 μm, Au 0.095 ± 0.025 μm*)

RoHS Compliance

This part is compliant with 2011/65/EU RoHS directive (Restrictions on the Use of Certain Hazardous Substances in Electrical and Electronic Equipment) as amended by Directive 2015/863/EU.

This product also has the following attributes:

- Lead Free
- Halogen Free (Chlorine, Bromine)
- Antimony Free
- TBBP-A (C₁₅H₁₂Br₄O₂) Free
- PFOS Free
- SVHC Free



Contact Information

For the latest specifications, additional product information, worldwide sales and distribution locations:

Web: www.qorvo.com

Tel: 1-844-890-8163

Email: customer.support@qorvo.com

Important Notice

The information contained herein is believed to be reliable; however, Qorvo makes no warranties regarding the information contained herein and assumes no responsibility or liability whatsoever for the use of the information contained herein. All information contained herein is subject to change without notice. Customers should obtain and verify the latest relevant information before placing orders for Qorvo products. The information contained herein or any use of such information does not grant, explicitly or implicitly, to any party any patent rights, licenses, or any other intellectual property rights, whether with regard to such information itself or anything described by such information. **THIS INFORMATION DOES NOT CONSTITUTE A WARRANTY WITH RESPECT TO THE PRODUCTS DESCRIBED HEREIN, AND QORVO HEREBY DISCLAIMS ANY AND ALL WARRANTIES WITH RESPECT TO SUCH PRODUCTS WHETHER EXPRESS OR IMPLIED BY LAW, COURSE OF DEALING, COURSE OF PERFORMANCE, USAGE OF TRADE OR OTHERWISE, INCLUDING THE IMPLIED WARRANTIES OF MERCHANTABILITY AND FITNESS FOR A PARTICULAR PURPOSE.**

Without limiting the generality of the foregoing, Qorvo products are not warranted or authorized for use as critical components in medical, life-saving, or life-sustaining applications, or other applications where a failure would reasonably be expected to cause severe personal injury or death.

Copyright 2019 © Qorvo, Inc. | Qorvo is a registered trademark of Qorvo, Inc.

Mouser Electronics

Authorized Distributor

Click to View Pricing, Inventory, Delivery & Lifecycle Information:

[Qorvo:](#)

[QPA9154EVB01](#) [QPA9154SR](#) [QPA9154TR7](#)