

IoT OPTIMIZED LOW PROFILE QUARTZ CRYSTAL



2.0 x 1.6 x 0.5mm



RoHS/RoHS II Compliant

MSL = N/A: NOT APPLICABLE

ABM11W SERIES

FEATURES

- Optimized for energy saving wearables, and IoT applications
- Plated at exceptionally low plating capacitance, as low as 4pF, with optimized ESR
- 0.5 mm max height ideally suited for height constrained designs
- Seam sealed for longterm reliability

APPLICATIONS

- Wearables
- Internet of Things (IoT)
- Bluetooth/Bluetooth Low Energy (BLE)
- Wireless modules
- Machine-to-machine (M2M) connectivity
- Ultra-low power MCU
- Near Field Communication (NFC)
- ISM Band

STANDARD SPECIFICATIONS

Parameters	Minimum	Typical	Maximum	Units	Notes
Frequency Range	16.0000		50.0000	MHz	
Operation Mode	Fundamental				
Operating Temperature Range	-40		+125	°C	See options
Storage Temperature	-55		+125	°C	
Frequency Tolerance @ +25°C	-10		+10	ppm	See options
Frequency Stability over the Operating Temperature (ref. to +25°C)	-10		+10	ppm	See options
Equivalent series resistance (R1) (over -40°C to +125°C)		< 150	200	Ω	16.0000 – 17.9999MHz
		< 80	120		18.0000 – 20.9999MHz
		< 60	100		21.0000 – 29.9999MHz
		< 50	80		30.0000 – 37.9999MHz
		< 30	60		38.0000 – 50.0000MHz
Shunt capacitance (C0)		< 1.0	2.0	pF	
Load capacitance (CL)		4.0		pF	See options
Drive Level		10	100	μW	
Aging (1 year)	-2		+2	ppm	@ 25°C±3°C
Insulation Resistance	500			MΩ	@ 100Vdc ± 15V

IoT OPTIMIZED LOW PROFILE QUARTZ CRYSTAL

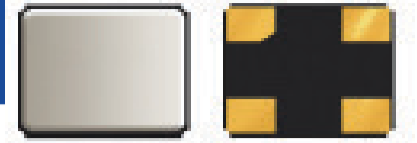

2.0 x 1.6 x 0.5mm



RoHS/RoHS II Compliant

MSL = N/A: NOT APPLICABLE

ABM11W SERIES

OPTIONS AND PART IDENTIFICATION (NOTE 1)

Note 1: Contact Abracon for part number requests with carrier frequency callouts up to 5 & 6 digit accuracy after the decimal.

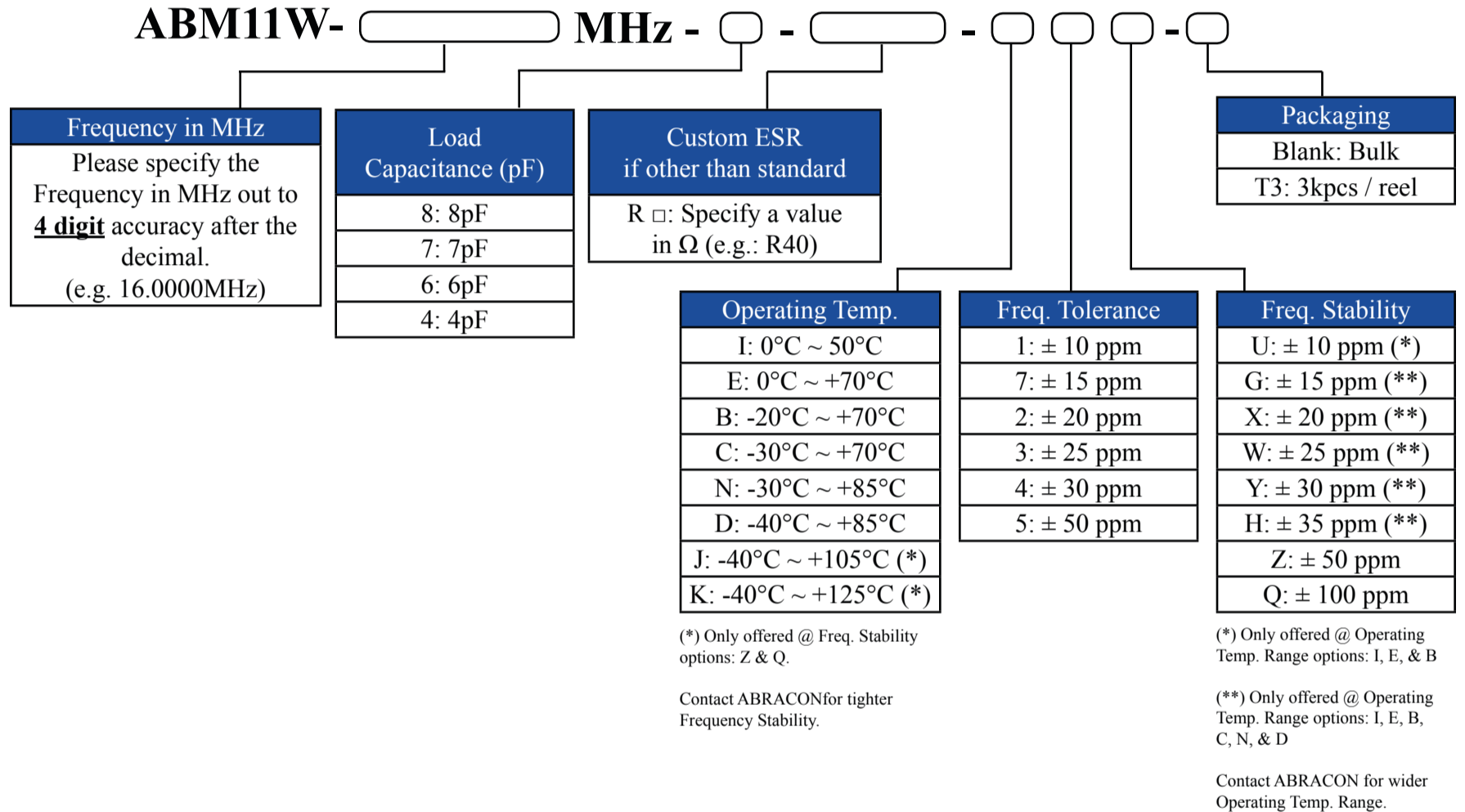

IoT OPTIMIZED LOW PROFILE QUARTZ CRYSTAL



ABM11W SERIES

2.0 x 1.6 x 0.5mm

RoHS/RoHS II Compliant

MSL = N/A: NOT APPLICABLE

TYPICAL ESR (EQUIVALENT SERIES RESISTANCE) Vs. TEMPERATURE CHARACTERISTICS

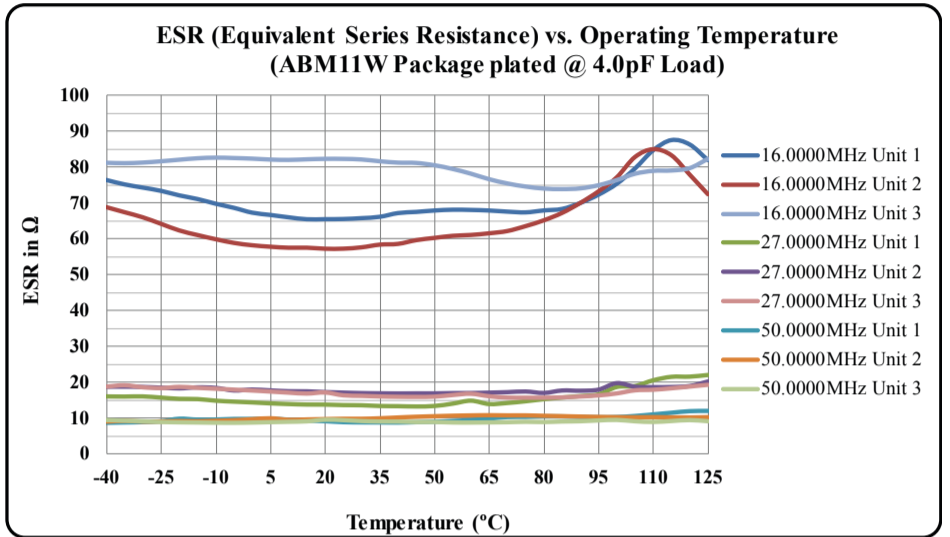
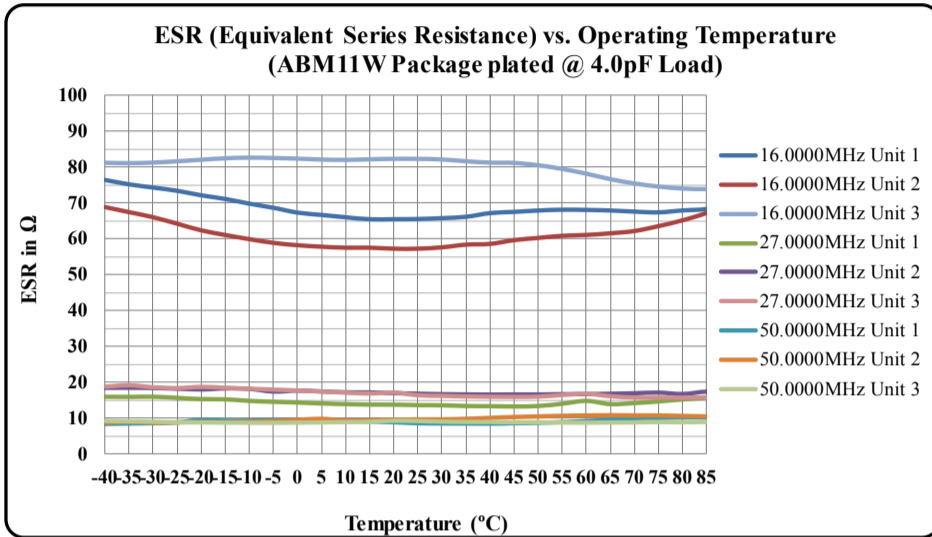

TYPICAL FREQUENCY Vs. TEMPERATURE CHARACTERISTICS

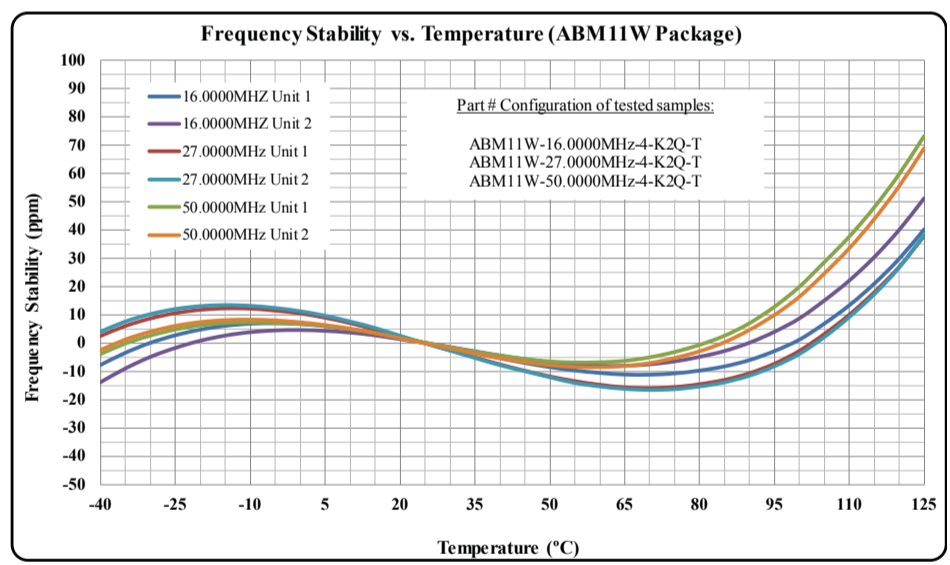
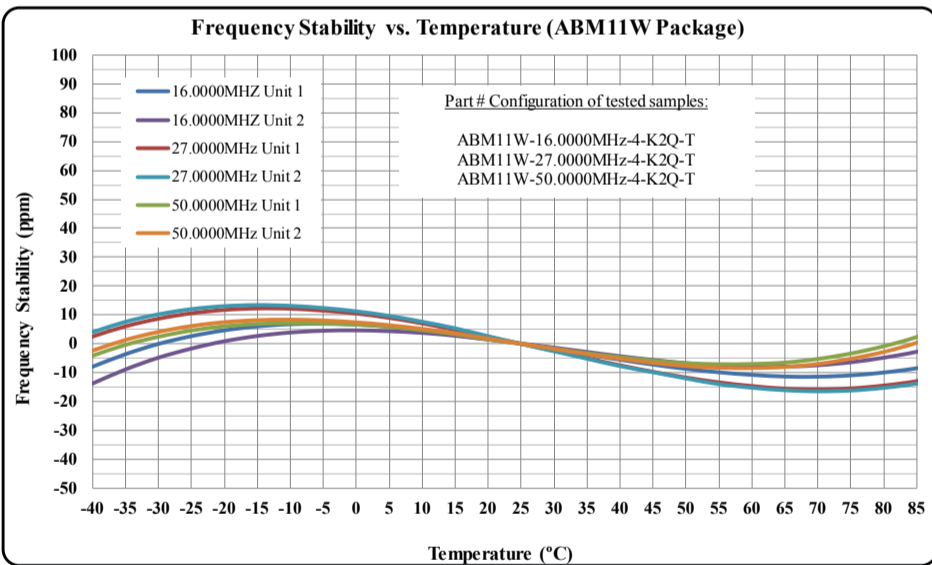

IoT OPTIMIZED LOW PROFILE QUARTZ CRYSTAL



ABM11W SERIES

2.0 x 1.6 x 0.5mm



RoHS/RoHS II Compliant

MSL = N/A: NOT APPLICABLE

TYPICAL FREQUENCY TOLERANCE DISTRIBUTION (AT 25°C ± 3°C)

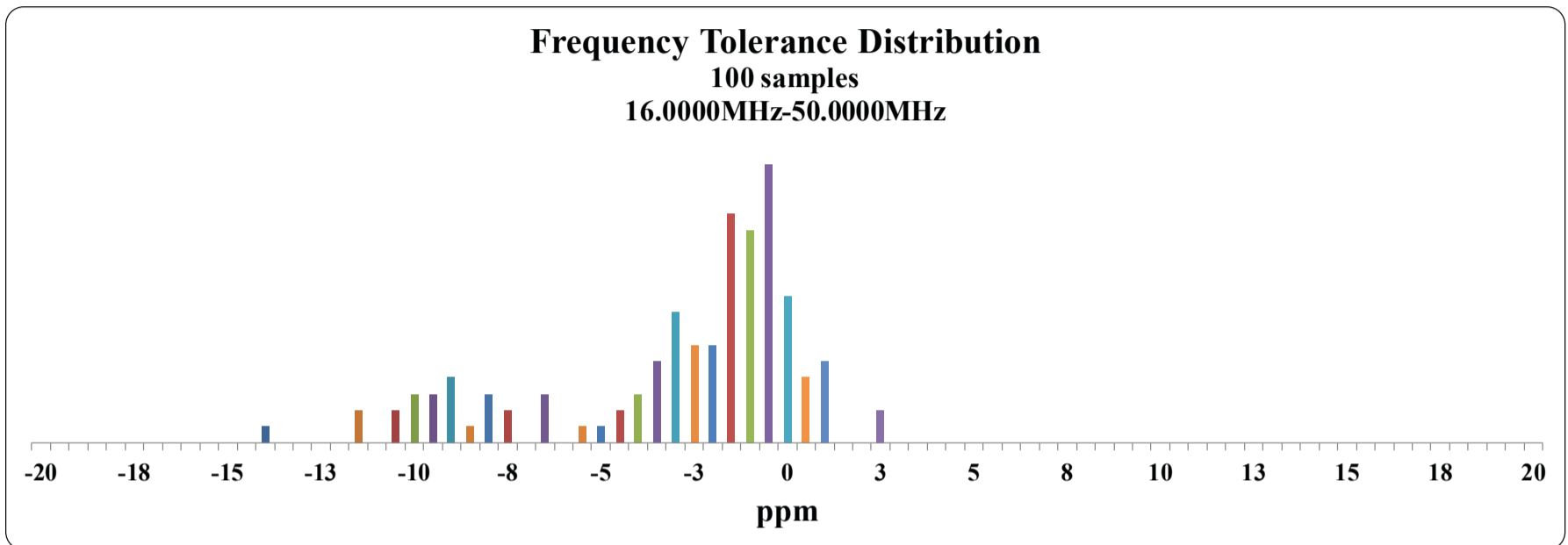

TYPICAL ESR DISTRIBUTION (AT 25°C ± 3°C)

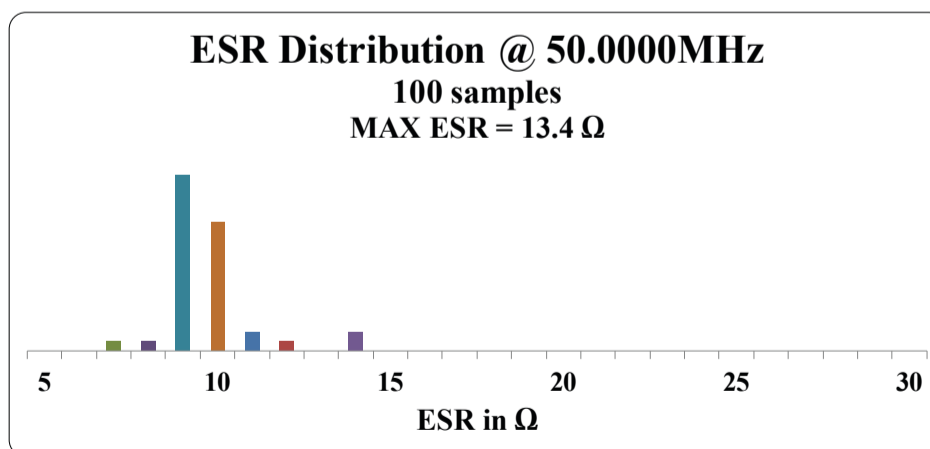
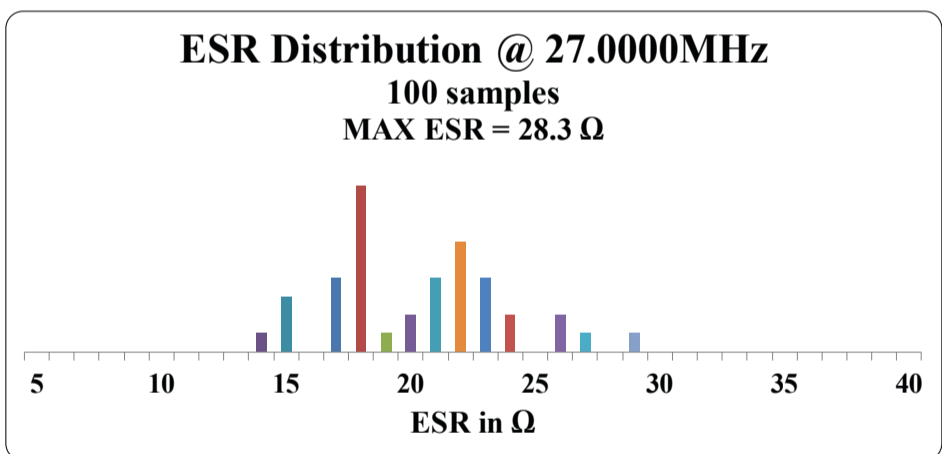
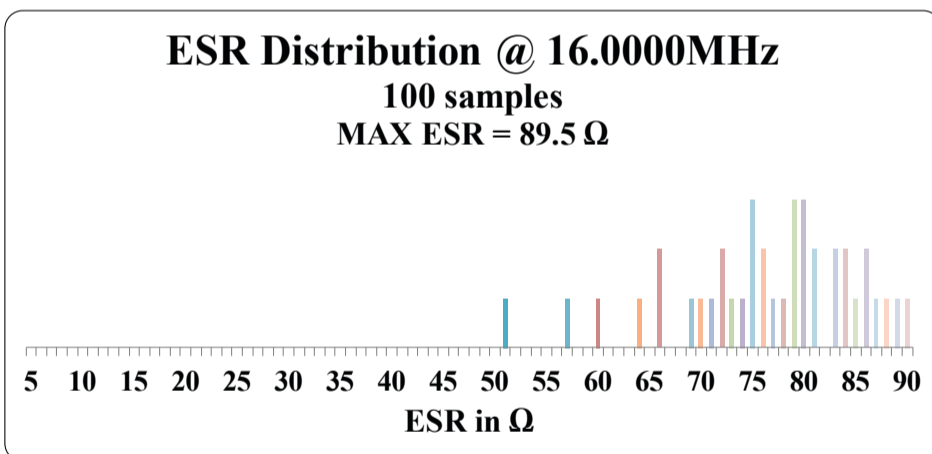

IoT OPTIMIZED LOW PROFILE QUARTZ CRYSTAL



ABM11W SERIES

2.0 x 1.6 x 0.5mm



RoHS/RoHS II Compliant

MSL = N/A: NOT APPLICABLE

SPICE MODELS (BASED ON TYPICAL VALUES AT 25°C ± 3°C)

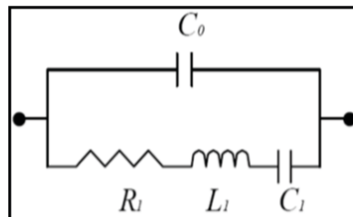

Frequency: 16.0000MHz Plating Load: 4pF			Frequency: 16.0000MHz Plating Load: 6pF		
C0	=	0.73 pF	C0	=	0.71 pF
R1	=	73.02 Ω	R1	=	81.42 Ω
L1	=	84.25 mH	L1	=	81.33 mH
C1	=	1.18 fF	C1	=	1.22 fF
Frequency: 27.0000MHz Plating Load: 4pF			Frequency: 27.0000MHz Plating Load: 6pF		
C0	=	0.78 pF	C0	=	0.76 pF
R1	=	18.71 Ω	R1	=	20.45 Ω
L1	=	18.08 mH	L1	=	18.44 mH
C1	=	1.92 fF	C1	=	1.89 fF
Frequency: 50.0000MHz Plating Load: 4pF			Frequency: 50.0000MHz Plating Load: 6pF		
C0	=	0.92 pF	C0	=	0.97 pF
R1	=	9.02 Ω	R1	=	8.49 Ω
L1	=	3.53 mH	L1	=	3.21 mH
C1	=	2.88 fF	C1	=	3.15 fF

MECHANICAL DIMENSIONS

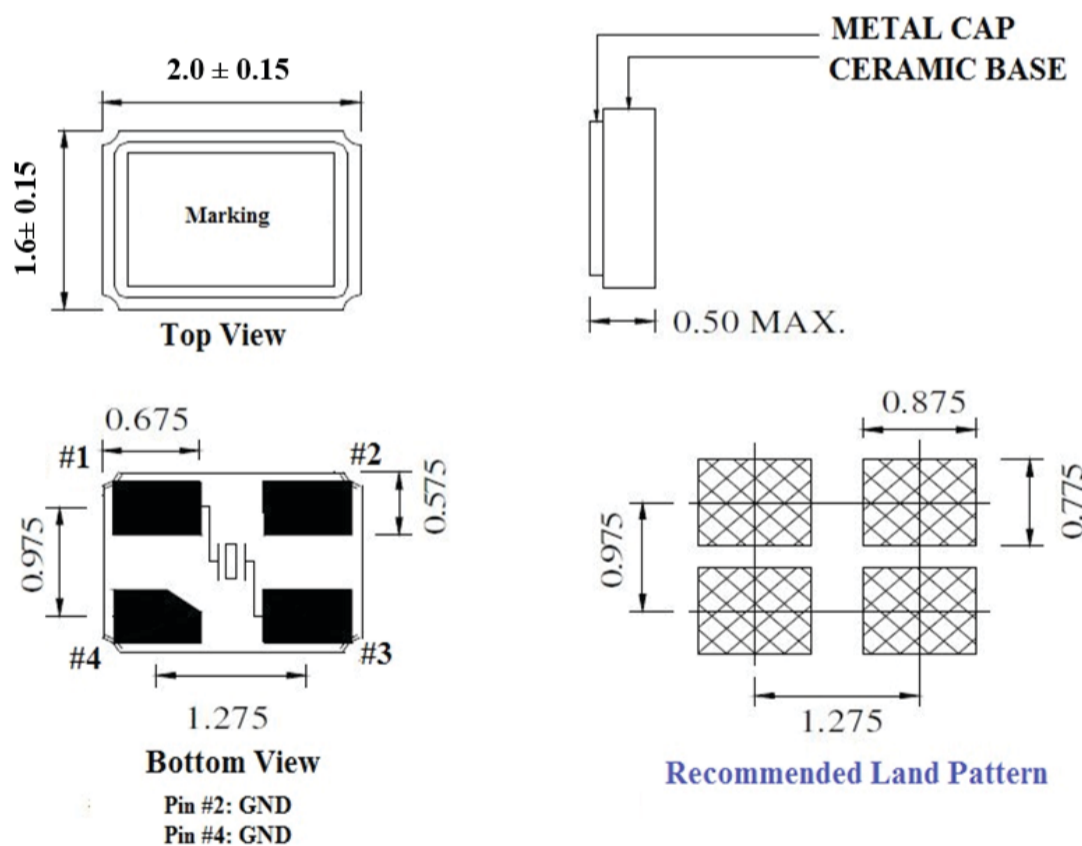

Note:

Due to material availability the Chamfer could be located on pin #1, 2 or 4. Be advised that the Chamfer location has no impact on the electrical performance of the device.

DIMENSIONS: MM

IoT OPTIMIZED LOW PROFILE QUARTZ CRYSTAL

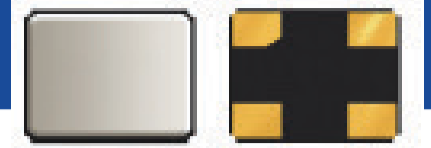

ABM11W SERIES

2.0 x 1.6 x 0.5mm



RoHS/RoHS II Compliant

MSL = N/A: NOT APPLICABLE

REFLOW PROFILE

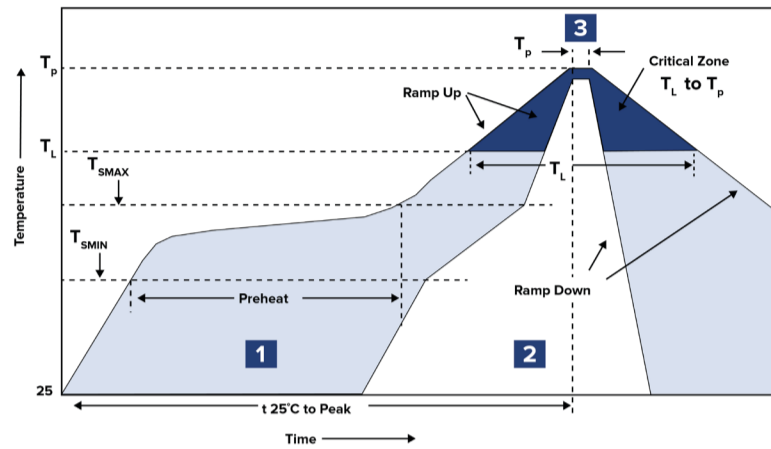

Zone	Description	Temperature	Time
1	Preheat	$T_{SMIN} \sim T_{SMAX}$ 150°C ~ 180°C	60 ~ 120 sec.
2	Reflow	T_L 217°C	45 ~ 90 sec.
3	Peak Heat	T_P 260°C MAX	10 sec.

PACKAGING

T3: Tape and reel (3,000 pcs/reel)

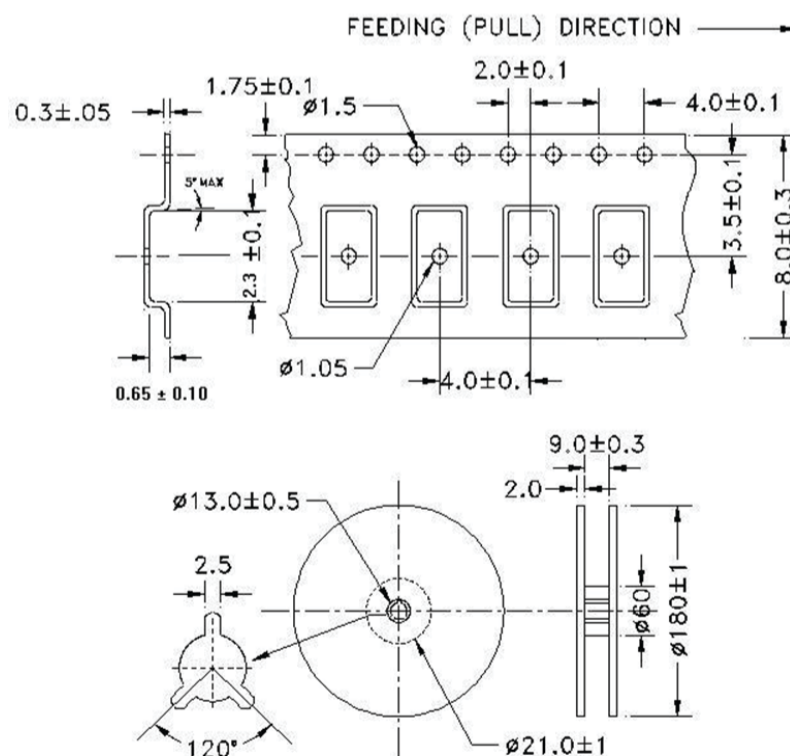

DIMENSIONS: mm

Mouser Electronics

Authorized Distributor

Click to View Pricing, Inventory, Delivery & Lifecycle Information:

ABRACON:

[ABM11W-31.2500MHZ-7-D2X-T3](#) [ABM11W-28.6364MHZ-4-J2J-T3](#) [ABM11W-38.0000MHZ-6-K1J-T3](#) [ABM11W-26.0410MHZ-6-K2J-T3](#) [ABM11W-24.0000MHZ-4-J1Z-T3](#) [ABM11W-19.4400MHZ-8-D1X-T3](#) [ABM11W-30.0000MHZ-7-K1Z-T3](#) [ABM11W-24.5455MHZ-4-J2Z-T3](#) [ABM11W-28.6364MHZ-4-D2X-T3](#) [ABM11W-27.1200MHZ-4-D1X-T3](#) [ABM11W-24.3050MHZ-4-J2J-T3](#) [ABM11W-31.2500MHZ-6-J2J-T3](#) [ABM11W-31.2500MHZ-4-J1Z-T3](#) [ABM11W-24.5454MHZ-7-J1J-T3](#) [ABM11W-38.0000MHZ-8-D2X-T3](#) [ABM11W-28.6364MHZ-4-J1Z-T3](#) [ABM11W-48.0000MHZ-6-K1Z-T3](#) [ABM11W-35.4160MHZ-6-J2Z-T3](#) [ABM11W-20.0000MHZ-8-D2X-T3](#) [ABM11W-44.0000MHZ-7-K2Z-T3](#) [ABM11W-29.4912MHZ-7-J1Z-T3](#) [ABM11W-50.0000MHZ-4-J2J-T3](#) [ABM11W-33.0000MHZ-7-K1Z-T3](#) [ABM11W-44.0000MHZ-4-J2Z-T3](#) [ABM11W-40.0000MHZ-8-K2J-T3](#) [ABM11W-35.4160MHZ-6-B2U-T3](#) [ABM11W-37.0500MHZ-8-J1J-T3](#) [ABM11W-38.0000MHZ-8-B2U-T3](#) [ABM11W-37.4000MHZ-8-J1Z-T3](#) [ABM11W-37.0500MHZ-6-J2Z-T3](#) [ABM11W-33.0000MHZ-7-K2Z-T3](#) [ABM11W-28.6364MHZ-8-J1Z-T3](#) [ABM11W-36.0000MHZ-7-D2X-T3](#) [ABM11W-40.0000MHZ-8-K1Z-T3](#) [ABM11W-33.0000MHZ-7-D2X-T3](#) [ABM11W-24.3050MHZ-4-D2X-T3](#) [ABM11W-24.9231MHZ-8-K2Z-T3](#) [ABM11W-19.2800MHZ-4-J1Z-T3](#) [ABM11W-26.0000MHZ-7-D1X-T3](#) [ABM11W-36.0000MHZ-8-K2J-T3](#) [ABM11W-33.3300MHZ-4-K1J-T3](#) [ABM11W-49.1520MHZ-8-K2J-T3](#) [ABM11W-33.0000MHZ-4-K2Z-T3](#) [ABM11W-48.0000MHZ-4-D2X-T3](#) [ABM11W-30.0000MHZ-7-K1J-T3](#) [ABM11W-24.5535MHZ-6-K1Z-T3](#) [ABM11W-37.0000MHZ-6-J1Z-T3](#) [ABM11W-24.5535MHZ-4-J1J-T3](#) [ABM11W-24.5535MHZ-7-J1Z-T3](#) [ABM11W-42.0000MHZ-4-J1Z-T3](#) [ABM11W-24.5727MHZ-7-K1Z-T3](#) [ABM11W-33.3330MHZ-4-J2Z-T3](#) [ABM11W-24.5760MHZ-6-J1Z-T3](#) [ABM11W-19.2000MHZ-7-K1Z-T3](#) [ABM11W-24.5535MHZ-7-B2U-T3](#) [ABM11W-27.1200MHZ-7-J1Z-T3](#) [ABM11W-50.0000MHZ-8-K2Z-T3](#) [ABM11W-42.0000MHZ-4-K1Z-T3](#) [ABM11W-49.1520MHZ-8-J1Z-T3](#) [ABM11W-19.9680MHZ-4-J1Z-T3](#) [ABM11W-16.0132MHZ-6-K2Z-T3](#) [ABM11W-24.5727MHZ-8-K2Z-T3](#) [ABM11W-33.3300MHZ-7-J2Z-T3](#) [ABM11W-28.2240MHZ-6-D1X-T3](#) [ABM11W-24.9231MHZ-6-B1U-T3](#) [ABM11W-24.5535MHZ-7-J1J-T3](#) [ABM11W-38.4000MHZ-4-B1U-T3](#) [ABM11W-44.0000MHZ-7-D1X-T3](#) [ABM11W-35.4160MHZ-8-D1X-T3](#) [ABM11W-21.9487MHZ-4-D1X-T3](#) [ABM11W-16.0000MHZ-6-B2U-T3](#) [ABM11W-33.3300MHZ-8-D2X-T3](#) [ABM11W-37.4000MHZ-7-J1Z-T3](#) [ABM11W-16.0000MHZ-4-J1J-T3](#) [ABM11W-24.5454MHZ-7-B2U-T3](#) [ABM11W-35.4160MHZ-7-K1Z-T3](#) [ABM11W-16.0132MHZ-8-J2Z-T3](#) [ABM11W-16.0000MHZ-6-J1J-T3](#) [ABM11W-50.0000MHZ-4-J2Z-T3](#) [ABM11W-28.6364MHZ-4-K2J-T3](#) [ABM11W-36.0000MHZ-8-D2X-T3](#) [ABM11W-35.4160MHZ-7-J1Z-T3](#) [ABM11W-33.3330MHZ-8-K2Z-T3](#) [ABM11W-16.0000MHZ-6-J1Z-T3](#) [ABM11W-29.4912MHZ-8-J1Z-T3](#) [ABM11W-19.2800MHZ-6-J2J-T3](#) [ABM11W-24.5454MHZ-4-J2Z-T3](#) [ABM11W-19.6608MHZ-4-J1J-T3](#) [ABM11W-26.0410MHZ-7-B1U-T3](#) [ABM11W-20.0000MHZ-8-K1Z-T3](#) [ABM11W-40.0000MHZ-8-J1J-T3](#) [ABM11W-44.0000MHZ-8-K1Z-T3](#) [ABM11W-28.3220MHZ-4-J1Z-T3](#) [ABM11W-16.0132MHZ-8-B2U-T3](#) [ABM11W-32.0000MHZ-6-D1X-T3](#) [ABM11W-33.0000MHZ-6-J1Z-T3](#) [ABM11W-33.3300MHZ-8-](#)

[J2J-T3](#) [ABM11W-26.0000MHZ-8-J2J-T3](#) [ABM11W-44.0000MHZ-6-J2J-T3](#) [ABM11W-38.0000MHZ-6-K1Z-T3](#)