

## FEATURES

**OP1dB: 18 dBm (typical at 7 GHz to 12 GHz)**

**P<sub>SAT</sub>: 22 dBm (typical at 7 GHz to 12 GHz)**

**Gain: 12 dB (typical at 7 GHz to 12 GHz)**

**OIP3: 30 dBm typical**

**Phase noise: -172 dBc/Hz at 10 kHz offset**

**Supply voltage: 5 V at 74 mA**

**6-lead, 2 mm × 2 mm LFCSP**

## APPLICATIONS

**Military and space**

**Test instrumentation**

**Communications**

## GENERAL DESCRIPTION

The ADL8150 is a self biased gallium arsenide (GaAs), monolithic microwave integrated circuit (MMIC), heterojunction bipolar transistor (HBT), low phase noise amplifier that operates from 6 GHz to 14 GHz. The amplifier provides 12 dB of typical signal gain, 18 dBm output power at 1 dB gain compression (OP1dB), and a typical output third-order intercept (OIP3) of 30 dBm. The amplifier requires 74 mA from a 5 V collector

## FUNCTIONAL BLOCK DIAGRAM

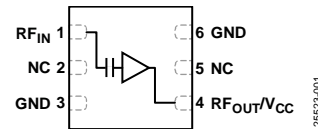

Figure 1.

supply voltage. The ADL8150 also features inputs and outputs (I/Os) that are internally matched to 50 Ω, and facilitates integration into multichip modules (MCMs).

Note that throughout this data sheet, multifunction pins, such as RF<sub>OUT</sub>/V<sub>CC</sub>, are referred to either by the entire pin name or by a single function of the pin, for example, RF<sub>OUT</sub>, when only that function is relevant.

## TABLE OF CONTENTS

Features .....	1	Electrostatic Discharge (ESD) Ratings .....	5
Applications .....	1	ESD Caution .....	5
Functional Block Diagram .....	1	Pin Configuration and Function Descriptions .....	6
General Description .....	1	Interface Schematics .....	6
Revision History .....	2	Typical Performance Characteristics .....	7
Specifications .....	3	Theory of Operation .....	13
Frequency Range: 6 GHz to 7 GHz .....	3	Applications Information .....	14
Frequency Range: 7 GHz to 12 GHz .....	3	Biasing Procedures .....	14
Frequency Range: 12 GHz to 14 GHz .....	4	Outline Dimensions .....	15
Absolute Maximum Ratings .....	5	Ordering Guide .....	15
Thermal Resistance .....	5		

## REVISION HISTORY

10/2020—Revision 0: Initial Version

**SPECIFICATIONS****FREQUENCY RANGE: 6 GHz TO 7 GHz**

Collector bias voltage ( $V_{CC}$ ) = 5 V, supply current ( $I_{CQ}$ ) = 74 mA and  $T_A = 25^\circ\text{C}$ , unless otherwise noted.

Table 1.

Parameter	Min	Typ	Max	Unit	Test Conditions/Comments
FREQUENCY RANGE	6		7	GHz	
GAIN	8	10.5		dB	
Gain Flatness		$\pm 1.0$		dB	
Gain Variation over Temperature		0.033		dB/ $^\circ\text{C}$	
NOISE FIGURE		4.8		dB	
PHASE NOISE		-172		dBc/Hz	Measurement taken at 10 kHz offset from carrier
RETURN LOSS					
Input		2		dB	
Output		14		dB	
OUTPUT					
OP1dB	15.5	17.5		dBm	Measurement taken at output power ( $P_{OUT}$ ) per tone = 6 dBm
Saturated Output Power ( $P_{SAT}$ )		20.5		dBm	
OIP3		30		dBm	
Output Second-Order Intercept (OIP2)		32		dBm	
SUPPLY					
$I_{CQ}$		74		mA	Self biased
$V_{CC}$	3	5	6	V	

**FREQUENCY RANGE: 7 GHz TO 12 GHz**

$V_{CC} = 5$  V,  $I_{CQ} = 74$  mA and  $T_A = 25^\circ\text{C}$ , unless otherwise noted.

Table 2.

Parameter	Min	Typ	Max	Unit	Test Conditions/Comments
FREQUENCY RANGE	7		12	GHz	
GAIN	10	12		dB	
Gain Flatness		$\pm 0.5$		dB	
Gain Variation over Temperature		0.024		dB/ $^\circ\text{C}$	
NOISE FIGURE		3.6		dB	
PHASE NOISE		-172		dBc/Hz	Measurement taken at 10 kHz offset from carrier
RETURN LOSS					
Input		7.5		dB	
Output		8		dB	
OUTPUT					
OP1dB	16	18		dBm	Measurement taken at $P_{OUT}$ per tone = 6 dBm
$P_{SAT}$		22		dBm	
OIP3		30		dBm	
OIP2		44.5		dBm	
SUPPLY					
$I_{CQ}$		74		mA	Self biased
$V_{CC}$	3	5	6	V	

**FREQUENCY RANGE: 12 GHz TO 14 GHz**

$V_{CC} = 5\text{ V}$ ,  $I_{CQ} = 74\text{ mA}$  and  $T_A = 25^\circ\text{C}$ , unless otherwise noted.

**Table 3.**

Parameter	Min	Typ	Max	Unit	Test Conditions/Comments
FREQUENCY RANGE	12		14	GHz	
GAIN	8	10.5		dB	
Gain Flatness		$\pm 0.9$		dB	
Gain Variation over Temperature		0.034		dB/ $^\circ\text{C}$	
NOISE FIGURE		3.8		dB	
PHASE NOISE		-172		dBc/Hz	Measurement taken at 10 kHz offset from carrier
RETURN LOSS					
Input		5		dB	
Output		8		dB	
OUTPUT					
OP1dB	15.5	17.5		dBm	
$P_{SAT}$		21.5		dBm	
OIP3		30		dBm	Measurement taken at $P_{OUT}$ per tone = 6 dBm
OIP2		60			Measurement taken at $P_{OUT}$ per tone = 6 dBm
SUPPLY					
$I_{CQ}$		74		mA	Self biased
$V_{CC}$	3	5	6	V	

## ABSOLUTE MAXIMUM RATINGS

Table 4.

Parameter	Rating
Collector Bias Voltage ( $V_{CC}$ )	6.5 V
Radio Frequency Input ( $RF_{IN}$ ) Power	25 dBm
Continuous Power Dissipation ( $P_{DISS}$ ), $T_A = 85^\circ\text{C}$ (Derate 15.9 mW/ $^\circ\text{C}$ Above $85^\circ\text{C}$ )	0.843 W
Temperature	
Storage Range	$-65^\circ\text{C}$ to $+150^\circ\text{C}$
Operating Range	$-40^\circ\text{C}$ to $+85^\circ\text{C}$
Peak Reflow (Moisture Sensitivity Level (MSL)) <sup>1</sup>	260°C
Junction Temperature to Maintain 1,000,000 Hours Mean Time to Failure (MTTF)	138°C
Nominal Junction Temperature ( $T_A = 85^\circ\text{C}$ , $V_{CC} = 5\text{ V}$ , $I_{CQ} = 74\text{ mA}$ )	108.3°C

<sup>1</sup> See the Ordering Guide for more information.

Stresses at or above those listed under Absolute Maximum Ratings may cause permanent damage to the product. This is a stress rating only; functional operation of the product at these or any other conditions above those indicated in the operational section of this specification is not implied. Operation beyond the maximum operating conditions for extended periods may affect product reliability.

### THERMAL RESISTANCE

Thermal performance is directly linked to printed circuit board (PCB) design and operating environment. Careful attention to PCB thermal design is required.

$\theta_{JC}$  is the junction to case thermal resistance.

Table 5. Thermal Resistance

Package Type	$\theta_{JC}$	Unit
CP-6-12	62.9	$^\circ\text{C}/\text{W}$

### ELECTROSTATIC DISCHARGE (ESD) RATINGS

The following ESD information is provided for handling of ESD-sensitive devices in an ESD protected area only.

Human body model (HBM) per ANSI/ESDA/JEDEC JS-001.

#### ESD Ratings for ADL8150

Table 6. ADL8150, 6-Lead LFCSP

ESD Model	Withstand Threshold (V)	Class
HBM	$\pm 1000$	1C

### ESD CAUTION



**ESD (electrostatic discharge) sensitive device.** Charged devices and circuit boards can discharge without detection. Although this product features patented or proprietary protection circuitry, damage may occur on devices subjected to high energy ESD. Therefore, proper ESD precautions should be taken to avoid performance degradation or loss of functionality.

# PIN CONFIGURATION AND FUNCTION DESCRIPTIONS

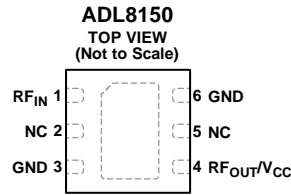

- NOTES**
1. NO CONNECT. THIS PIN IS NOT CONNECTED INTERNALLY. THIS PIN MUST BE CONNECTED TO THE RF AND DC GROUND.
  2. EXPOSED PAD. THE EXPOSED PAD MUST BE CONNECTED TO RF AND DC GROUND.

25523-002

Figure 2. Pin Configuration

Table 7. Pin Function Descriptions

Pin No.	Mnemonic	Description
1	RF <sub>IN</sub>	RF Input. This pin is ac-coupled and matched to 50 Ω. See Figure 5 for the interface schematic.
2, 5	NC	No Connect. This pin is not connected internally. This pin must be connected to the RF and dc ground.
3, 6	GND	Ground. This pin must be connected to the RF and dc ground. See Figure 3 for the interface schematic.
4	RF <sub>OUT</sub> /V <sub>CC</sub>	RF Output/Collector Bias for Amplifier. This pin is dc-coupled and matched to 50 Ω. See Figure 4 for the interface schematic.
	EPAD	Exposed Pad. The exposed pad must be connected to RF and dc ground.

## INTERFACE SCHEMATICS



25523-003

Figure 3. GND Interface Schematic

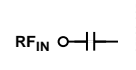

25523-005

Figure 5. RF<sub>IN</sub> Interface Schematic

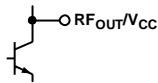

25523-004

Figure 4. RF<sub>OUT</sub>/V<sub>CC</sub> Interface Schematic

# TYPICAL PERFORMANCE CHARACTERISTICS

$I_{CQ}$  is the collector current without RF signal applied, and  $I_{CC}$  is the collector current with RF signal applied.

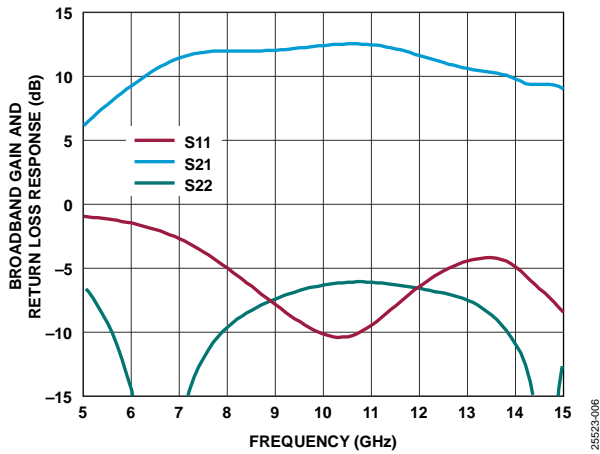

Figure 6. Broadband Gain and Return Loss Response vs. Frequency

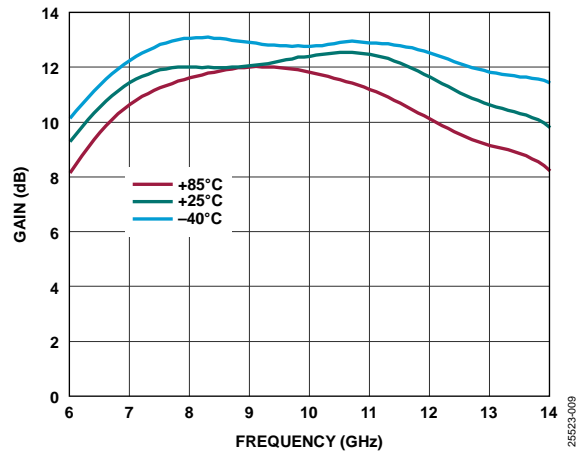

Figure 9. Gain vs. Frequency for Various Temperatures

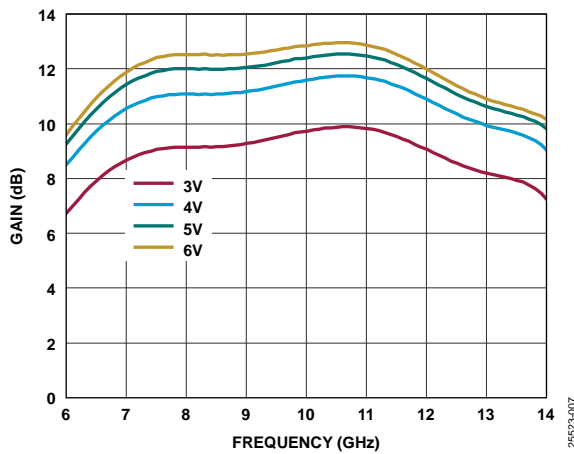

Figure 7. Gain vs. Frequency for Various Supply Voltages

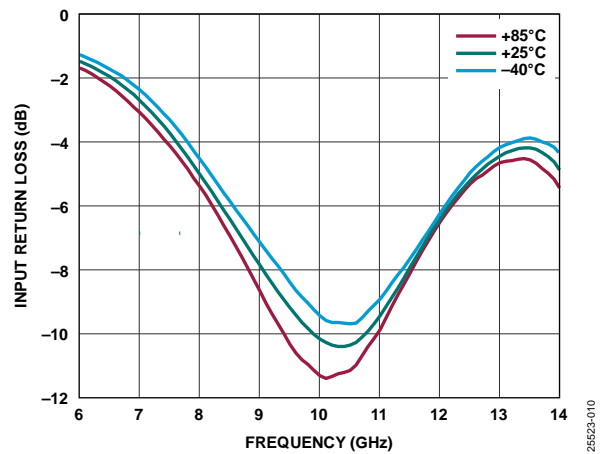

Figure 10. Input Return Loss vs. Frequency for Various Temperatures

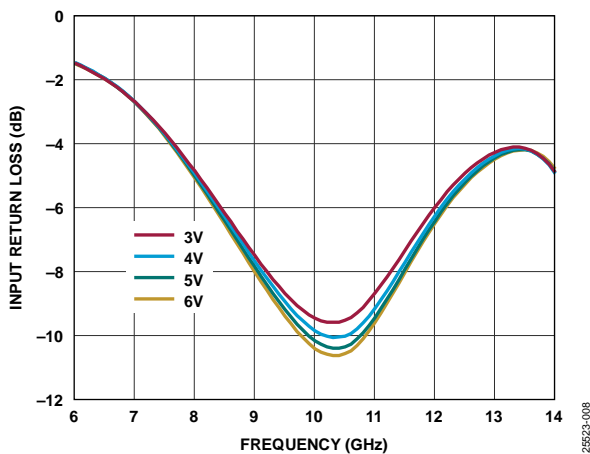

Figure 8. Input Return Loss vs. Frequency for Various Supply Voltages

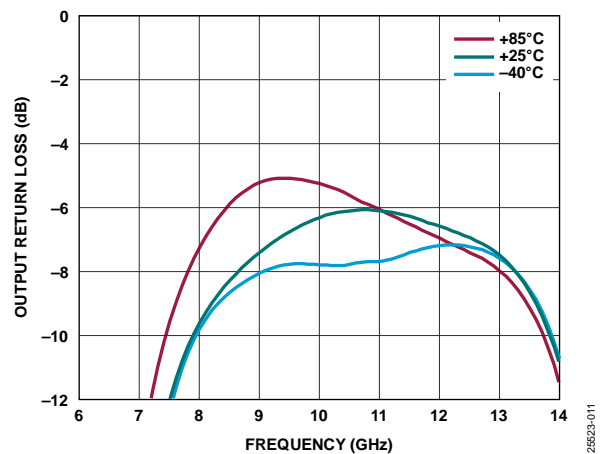

Figure 11. Output Return Loss vs. Frequency for Various Temperatures

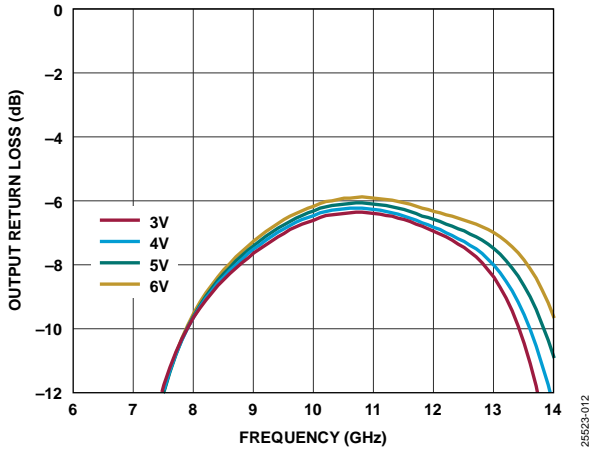

Figure 12. Output Return Loss vs. Frequency for Various Supply Voltages

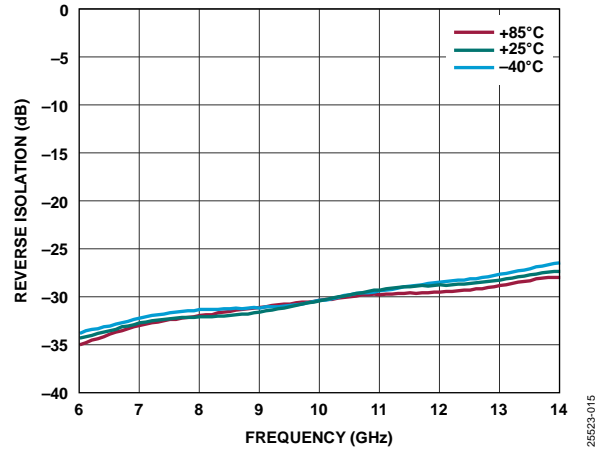

Figure 15. Reverse Isolation vs. Frequency for Various Temperatures

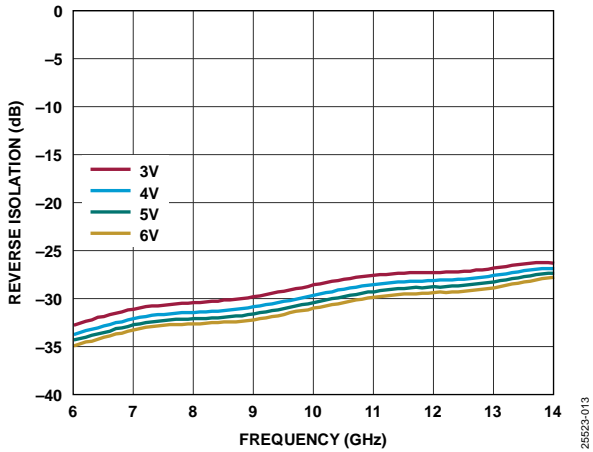

Figure 13. Reverse Isolation vs. Frequency for Various Supply Voltages

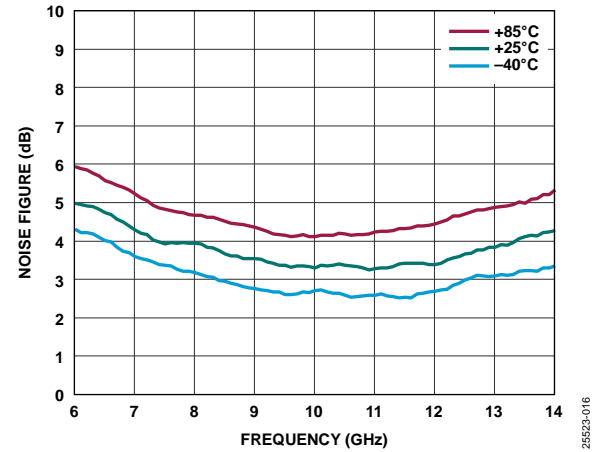

Figure 16. Noise Figure vs. Frequency for Various Temperatures

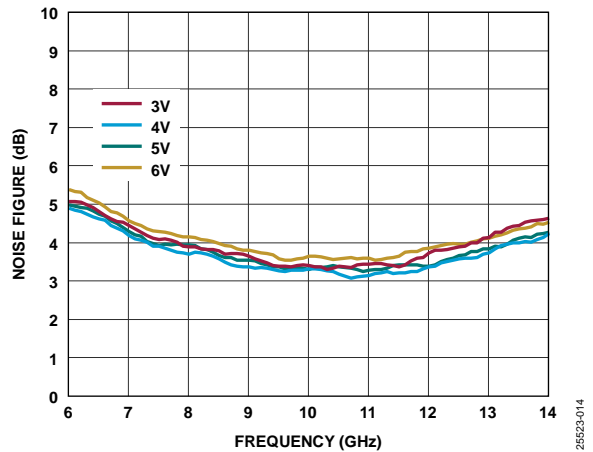

Figure 14. Noise Figure vs. Frequency for Various Supply Voltages

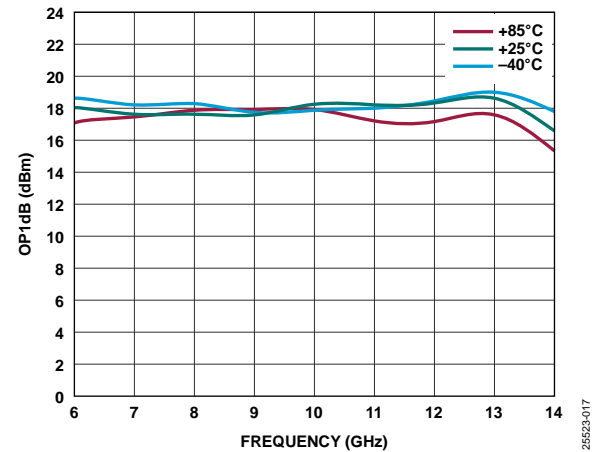

Figure 17. OP1dB vs. Frequency for Various Temperatures



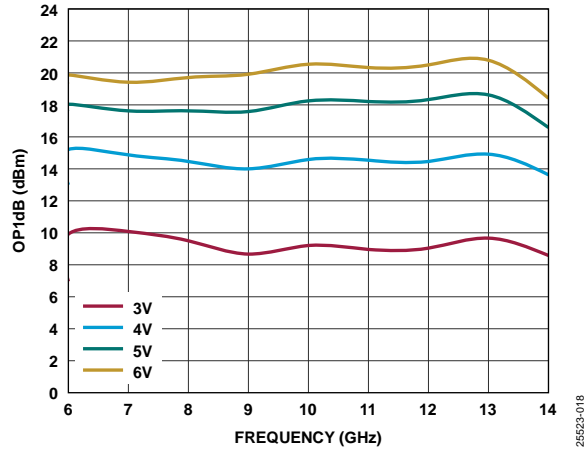

Figure 18. OP1dB vs. Frequency for Various Supply Voltages

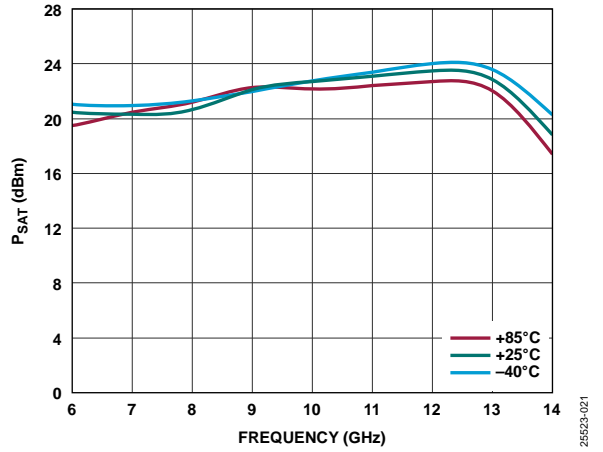

Figure 21. P<sub>SAT</sub> vs. Frequency for Various Temperatures

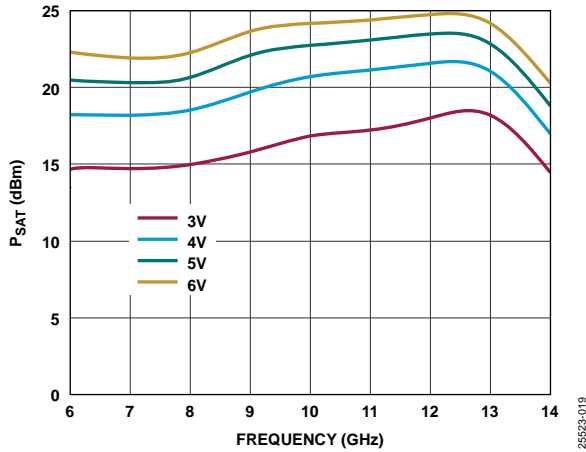

Figure 19. P<sub>SAT</sub> vs. Frequency for Various Supply Voltages

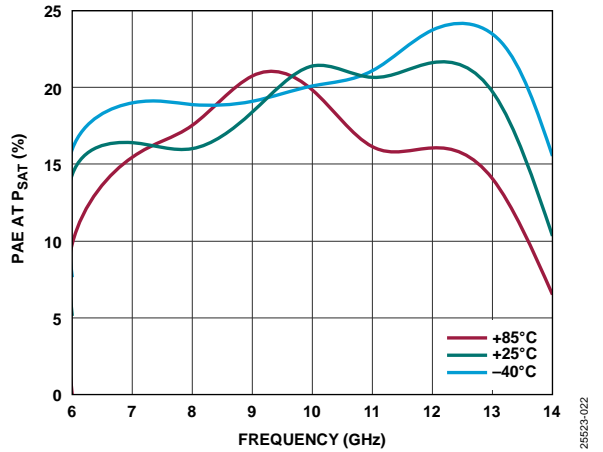

Figure 22. PAE at P<sub>SAT</sub> vs. Frequency for Various Temperatures

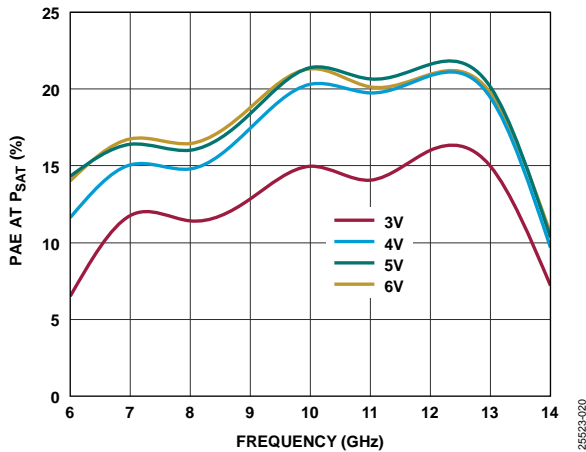

Figure 20. PAE at P<sub>SAT</sub> vs. Frequency for Various Supply Voltages

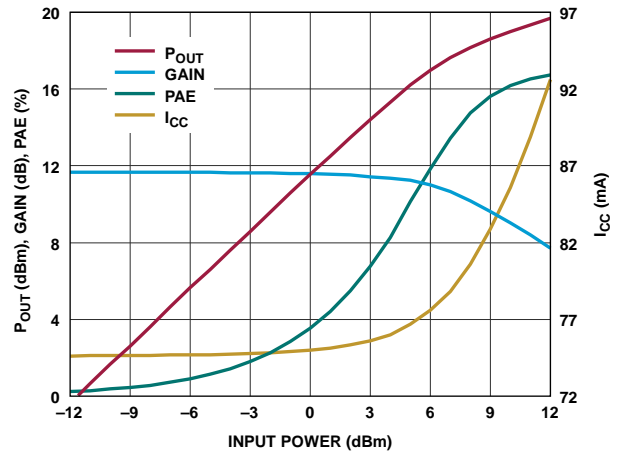

Figure 23. P<sub>OUT</sub>, Gain, PAE, and I<sub>CC</sub> vs. Input Power, Frequency = 7 GHz

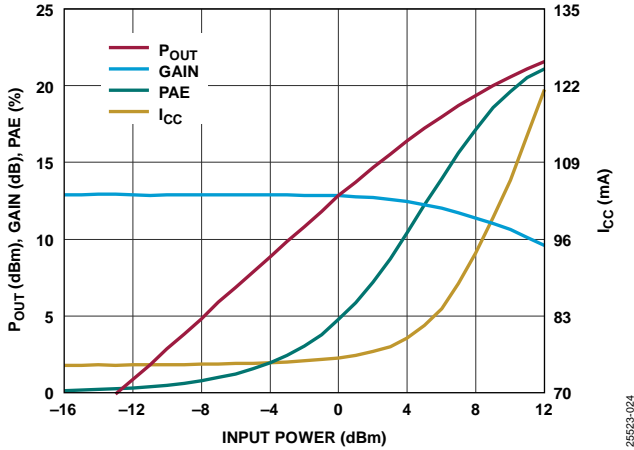

Figure 24.  $P_{OUT}$ , Gain, PAE, and  $I_{CC}$  vs. Input Power, Frequency = 10 GHz

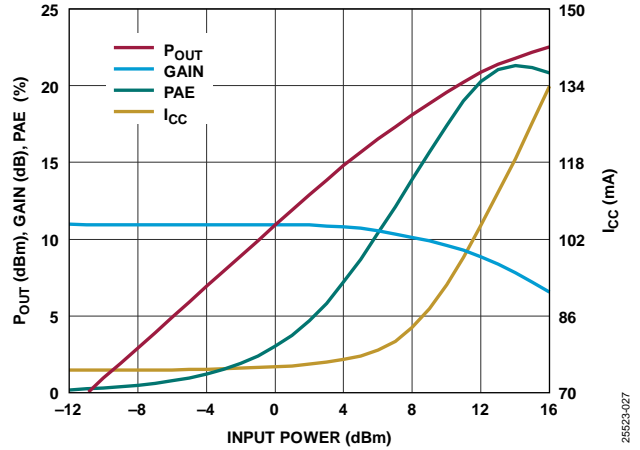

Figure 27.  $P_{OUT}$ , Gain, PAE, and  $I_{CC}$  vs. Input Power, Frequency = 13 GHz

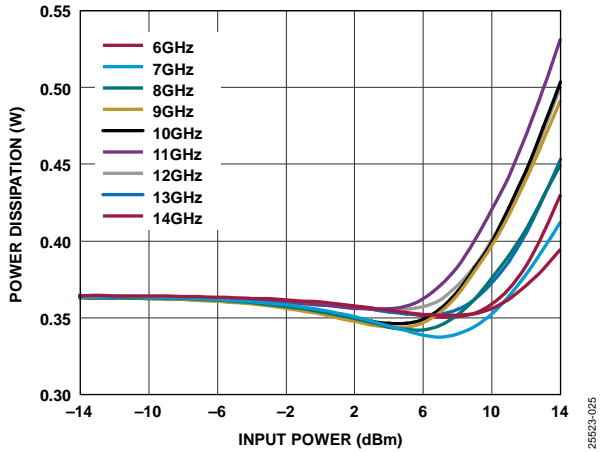

Figure 25. Power Dissipation vs. Input Power for Various Frequencies,  $T_A = 85^\circ\text{C}$

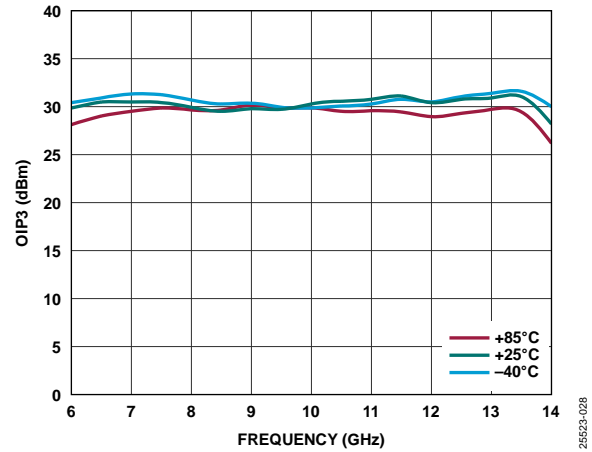

Figure 28.  $OIP3$  vs. Frequency for Various Temperatures,  $P_{OUT}$  per Tone = 6 dBm,  $V_{CC} = 5\text{ V}$

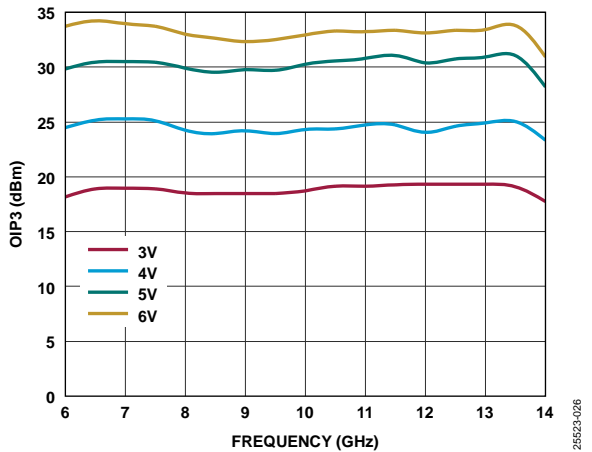

Figure 26.  $OIP3$  vs. Frequency for Various Supply Voltages,  $P_{OUT}$  per Tone = 6 dBm,  $V_{CC} = 5\text{ V}$

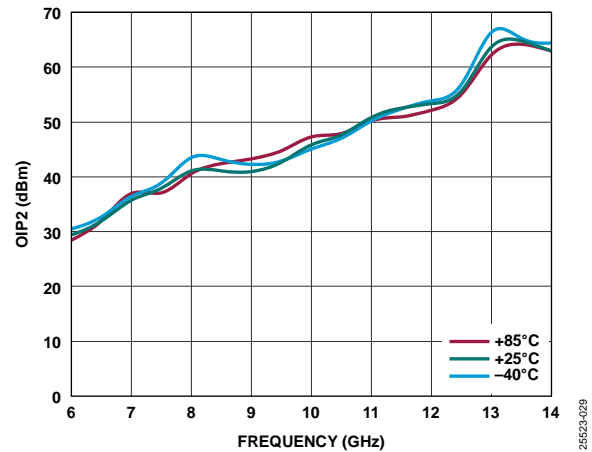

Figure 29.  $OIP2$  vs. Frequency for Various Temperatures,  $P_{OUT}$  per Tone = 6 dBm,  $V_{CC} = 5\text{ V}$

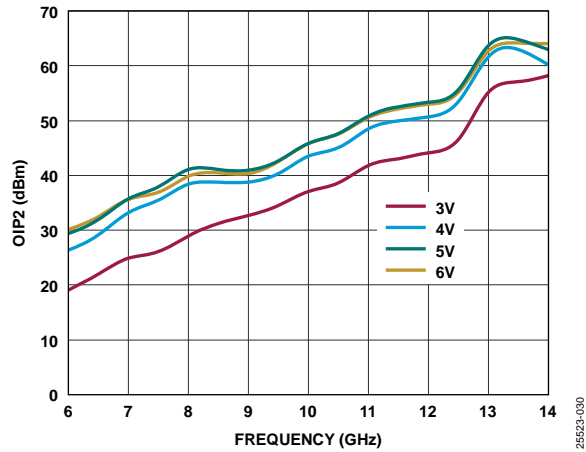

Figure 30. OIP2 vs. Frequency for Various Supply Voltages,  $P_{OUT}$  per Tone = 6 dBm,  $V_{CC} = 5$  V

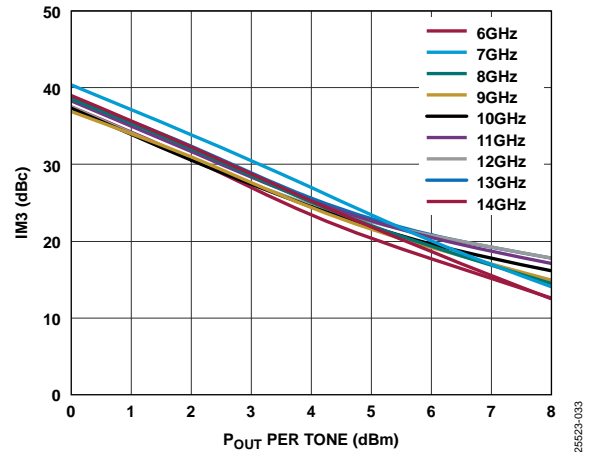

Figure 33. IM3 vs.  $P_{OUT}$  per Tone for Various Frequencies at  $V_{CC} = 3$  V

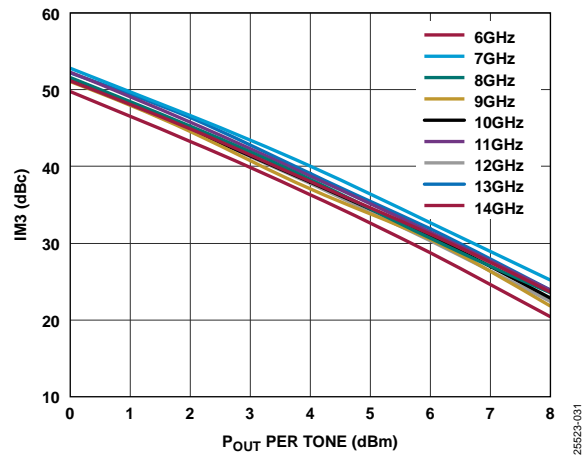

Figure 31. Third-Order Intermodulation Distortion (IM3) vs.  $P_{OUT}$  per Tone for Various Frequencies at  $V_{CC} = 4$  V

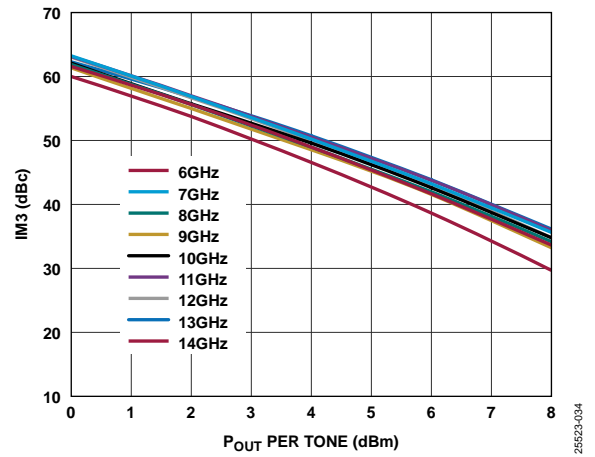

Figure 34. IM3 vs.  $P_{OUT}$  per Tone for Various Frequencies at  $V_{CC} = 5$  V

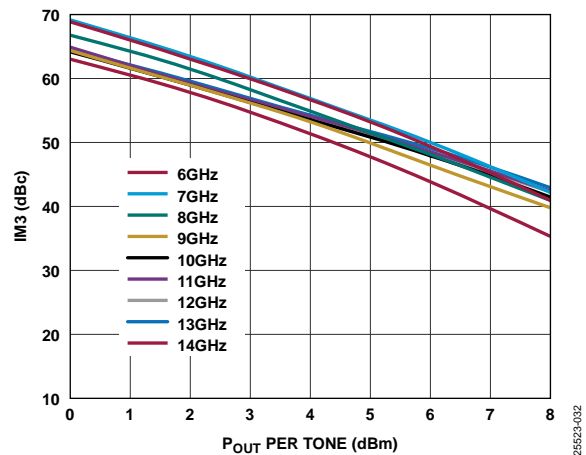

Figure 32. IM3 vs.  $P_{OUT}$  per Tone for Various Frequencies at  $V_{CC} = 6$  V

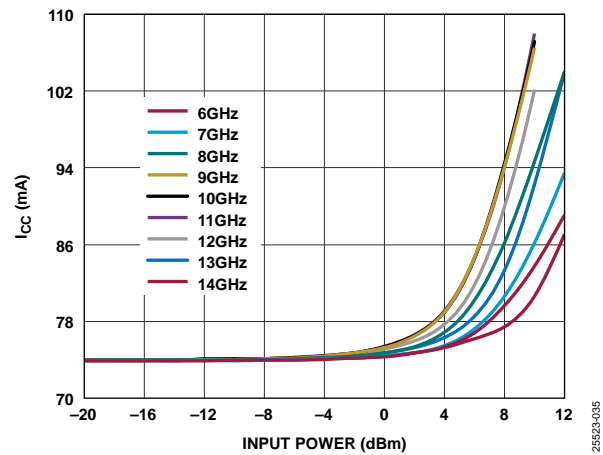

Figure 35.  $I_{CC}$  vs. Input Power for Various Frequencies at  $V_{CC} = 5$  V

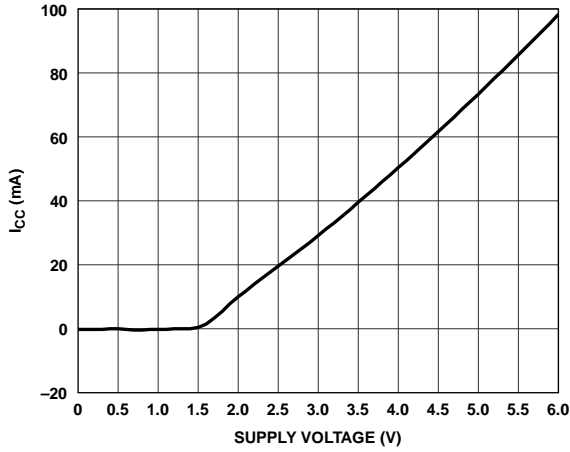

Figure 36.  $I_{CC}$  vs. Supply Voltage

25523-036

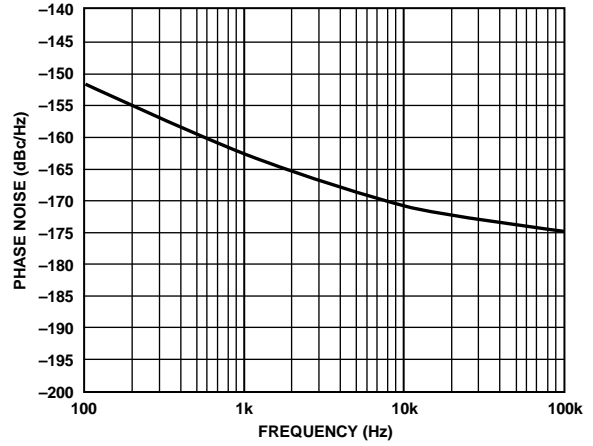

Figure 38. Phase Noise vs. Frequency at 10 GHz,  $P_{OUT} = P_{SAT}$

25523-038

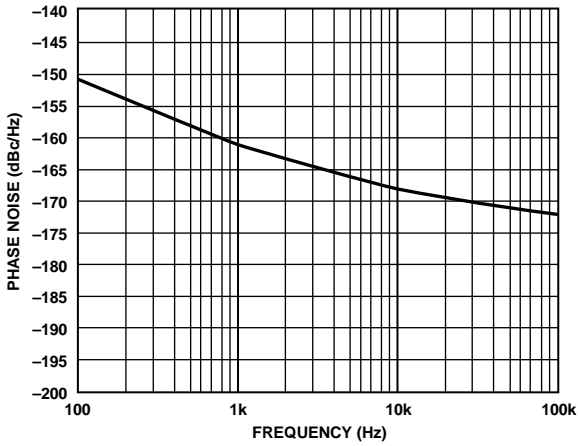

Figure 37. Phase Noise vs. Frequency at 10 GHz,  $P_{OUT} = 10 \text{ dBm}$

25523-037

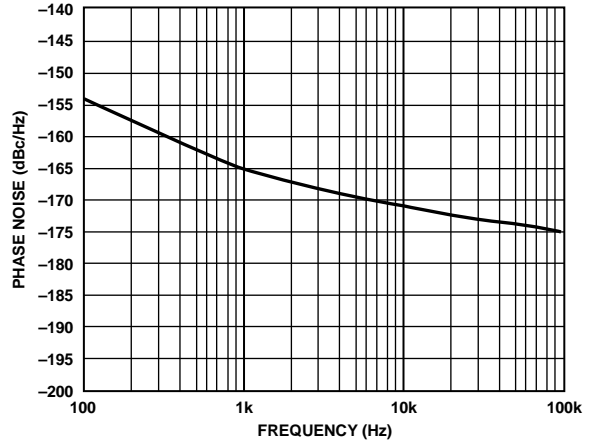

Figure 39. Phase Noise vs. Frequency at 10 GHz,  $P_{OUT} = P1\text{dB}$

25523-039

## THEORY OF OPERATION

The ADL8150 is a self biased, single 5 V power supply amplifier.  $RF_{IN}$  is ac-coupled, and  $RF_{OUT}/V_{CC}$  requires an external bias tee. Figure 40 shows the simplified block diagram.

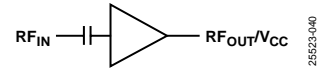

Figure 40. Simplified Block Diagram

## APPLICATIONS INFORMATION

### BIASING PROCEDURES

The ADL8150 is a self biased GaAs, MMIC, HBT, low phase noise amplifier. Figure 41 shows the typical application circuit. The choice of L1 and C4 are critical to obtain the performance specified in this data sheet. L1 is a Coilcraft 0402DF-560XJR, 56 nH inductor. C4 is an American Technical Ceramics, 531Z104KTR16T, 0.1  $\mu$ F capacitor.

Power the ADL8150 from a well regulated, ultra low noise power source. The [LT3045EDD#PBF](#) ultra low noise, ultrahigh power supply ripple rejection (PSRR) linear regulator is recommended.

All of these components are included in the ADL8150 evaluation board circuit. For more details, see the [ADL8150-EVALZ](#) user guide.

Adhere to the following bias sequence during power-up:

1. Connect the  $V_{CC}$  pin to the power supply.
2. Set the  $V_{CC}$  pin to 5 V.
3. Apply the RF input signal.

Adhere to the following bias sequence during power-down:

1. Turn off the RF input signal.
2. Set the  $V_{CC}$  pin to 0 V.

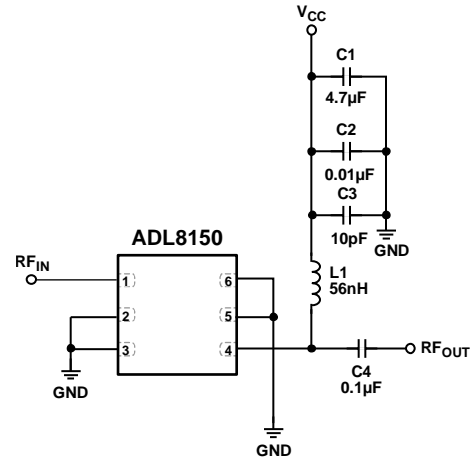

Figure 41. Typical Application Circuit

25523-041

# OUTLINE DIMENSIONS

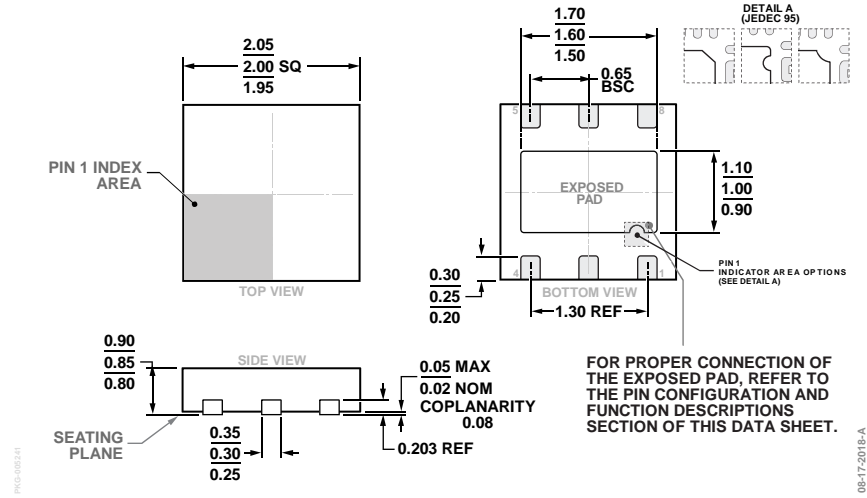

Figure 42. 6-Lead Lead Frame Chip Scale Package [LFCSP]  
 2 mm × 2 mm Body and 0.85 mm Package Height  
 (CP-6-12)  
 Dimensions shown in millimeters

## ORDERING GUIDE

Model <sup>1, 2</sup>	Temperature Range	MSL Rating <sup>3</sup>	Package Description <sup>4</sup>	Package Option
ADL8150ACPZN	-40°C to +85°C	MSL3	6-Lead Lead Frame Chip Scale Package [LFCSP]	CP-6-12
ADL8150ACPZN-R7	-40°C to +85°C	MSL3	6-Lead Lead Frame Chip Scale Package [LFCSP]	CP-6-12
ADL8150-EVALZ			Evaluation Board	

<sup>1</sup> Z = RoHS Compliant Part.  
<sup>2</sup> When ordering the evaluation board only, reference the model number, ADL8150-EVALZ.  
<sup>3</sup> See the Absolute Maximum Ratings section for additional information.  
<sup>4</sup> The lead finish of the ADL8150ACPZN and ADL8150ACPZN-R7 is nickel palladium gold (NiPdAu).

# Mouser Electronics

Authorized Distributor

Click to View Pricing, Inventory, Delivery & Lifecycle Information:

[Analog Devices Inc.:](#)

[ADL8150ACPZN-R7](#) [ADL8150ACPZN](#)