

ISO VIEW
SCALE 1:1

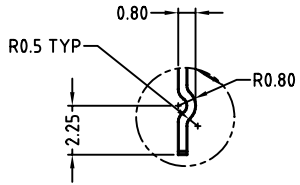

DETAIL A
SCALE 4:1

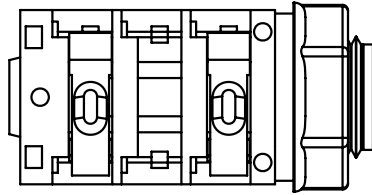
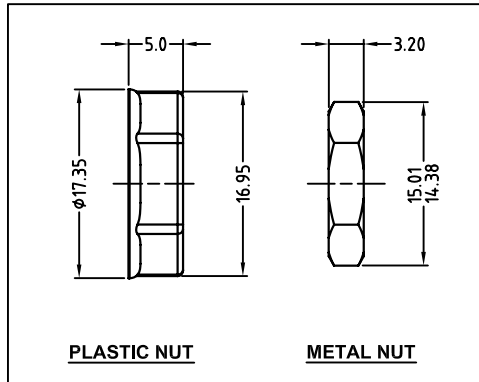
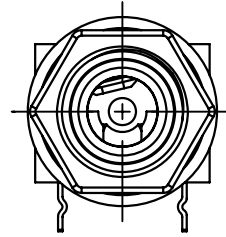
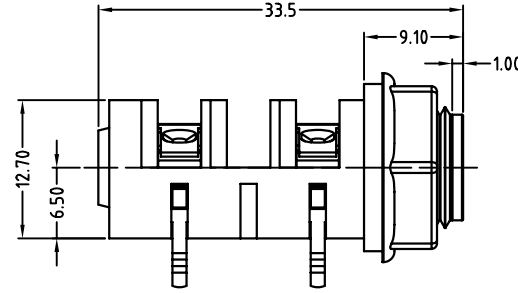
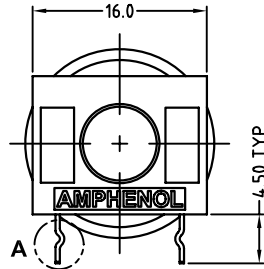

PLASTIC NUT

METAL NUT

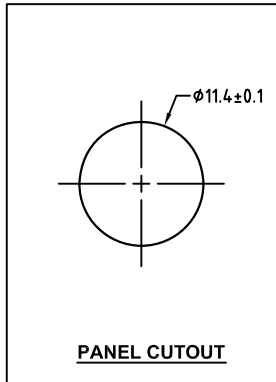

PANEL CUTOUT

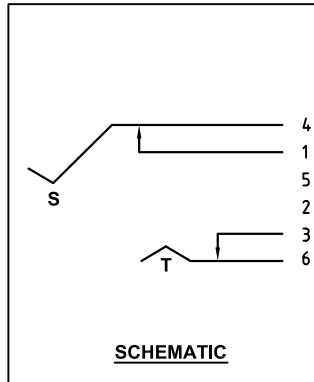

SCHEMATIC

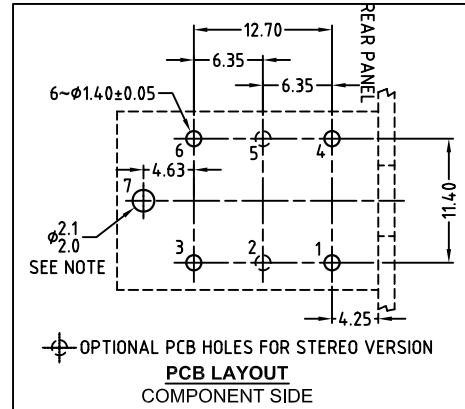

PCB LAYOUT
COMPONENT SIDE
OPTIONAL PCB HOLES FOR STEREO VERSION

CATALOGUE P/N	ASSEMBLY P/N	NUT OPTIONS
ACJM-PHDR	55010153-502	PLASTIC
ACJM-MHDR	55010153-302	METAL

NOTE: OPTIONAL MOUNTING HOLE FOR SELF-TAPPING M2 SCREW

UNLESS OTHERWISE SPECIFIED TOLERANCE TO BE		THIS DOCUMENT IS THE PROPERTY OF AMPHENOL AUSTRALIA PTY. LTD. NO PART THEREOF MAY BE REPRODUCED AND USED WITHOUT THE PRIOR WRITTEN CONSENT OF THE OWNER			
LINEAR	ANGULAR	CAD FILE: 55010153502222	DRN: L.V	DATE: 18-06-02	TITLE:
X ± 0.5	X° ± 1°	MATL: REFER TO COMPONENTS	CKD: M.N.H	DATE: 17-05-06	1/4" PHONE MONO JACK
X.X ± 0.1	X°X' ± 30'	DO NOT SCALE	FINISH: REFER TO COMPONENTS	DATE: 17-05-06	
X.XX ± 0.05	X°X'X" ± 15"	DIMENSIONS IN MILLIMETRES		SCALE: 2:1 UOS	CUSTOMER DRAWING
BREAK ALL SHARP EDGES AND REMOVE ALL BURRS		THIRD ANGLE PROJECTION		PART No: REFER TO CHART	

2	CHANGE PLASTIC NUT FROM P/N: 52170018-531 TO P/N: 52170032-531	L.V	31-01-05	8333
1	UPDATE TO COMPLY WITH MODIFIED COMPONENTS	L.V	11-06-03	8184
0	FIRST ISSUE	L.V	18-06-02	----
REV.	CHANGE DETAILS	BY	DATE	CHG/No

Amphenol
Amphenol Australia Pty.Ltd, 2 Fireweys Blvd, Keysborough, Vic3173
DRAWING NO. 55010153-502-2
SHEET 2 OF 2

Mouser Electronics

Authorized Distributor

Click to View Pricing, Inventory, Delivery & Lifecycle Information:

[Amphenol:](#)

[ACJM-MHDR](#)