

Power Operational Amplifier



FEATURES

- Up to 2400V_{p-p} Output
- Wide Supply Range - $\pm 100V$ to $\pm 1250V$
- Programmable Current Limit
- 50mA Continuous Output
- Hermetically Sealed Package
- Temperature Sensor

APPLICATIONS

- Semiconductor Testing
- Piezo Positioning
- High Voltage Instrumentation
- Electrostatic Deflection

DESCRIPTION

The PA99 is an ultra-high 2,500 V power operational amplifier designed for output currents up to 50mA to target high voltage applications including piezoelectric positioning, instrumentation, semiconductor production testing, and electrostatic deflection. Output voltages can swing up to 2,400 V_{p-p}.

High accuracy for this MOSFET power amplifier is achieved with a cascode input circuit configuration. External compensation provides user flexibility by allowing customers to tailor slew rate and bandwidth performance. A resistor configurable current limit provides system level protection.

TYPICAL CONNECTION

Figure 1: Typical Connection

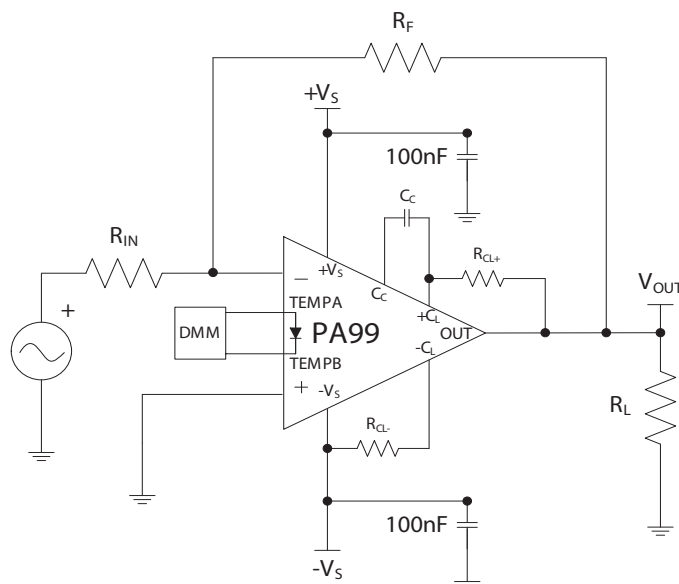

PINOUT AND DESCRIPTION TABLE

Figure 2: External Connections

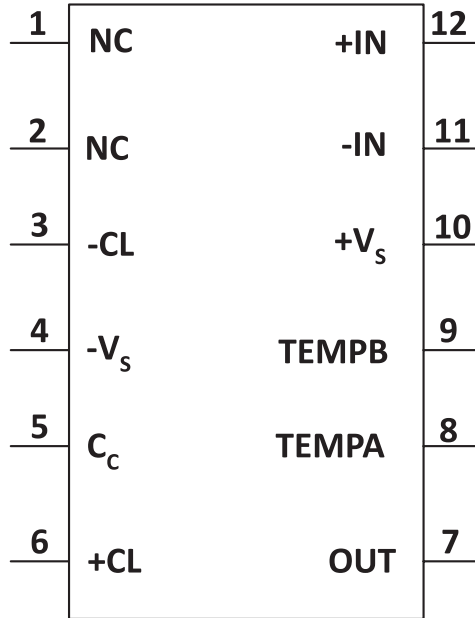

Pin Number	Name	Description
1, 2	NC	No connection.
3	-CL	Connect a negative current limit resistor between this pin and -Vs pin.
4	-Vs	The negative supply rail.
5	CC	Connect a compensation capacitor between this pin and +CL pin. The compensation capacitor needs to be rated for at least the maximum supply voltage.
6	+CL	Connect a positive current limit resistor between this pin and the OUT pin. Output current flows out of this pin through R _{CL+} .
7	OUT	The output. Connect this pin to load and to the feedback resistors.
8	TEMPA	The anode for the temperature sensing diode.
9	TEMPB	The cathode for the temperature sensing diode.
10	+Vs	The positive supply rail.
11	-IN	The inverting input.
12	+IN	The non-inverting input.

SPECIFICATIONS

Unless noted otherwise, the test conditions are as follows: $T_C = 25^\circ\text{C}$, $\Delta V_S = 2000\text{V}$, $R_L = 50\text{ k}\Omega$, $A_V = 100$, $R_F = 200\text{ k}\Omega$, $C_C = 15\text{pF}$. DC input specifications are value given. The power supply voltage is typical rating.

ABSOLUTE MAXIMUM RATINGS

Parameter	PA99 & PA99A			Unit
	Symbol	Min	Max	
Supply Voltage	$+V_S$ to $-V_S$		2500	V
Output Current, Peak, within SOA	I_O		± 70	mA
Power Dissipation, internal, DC	P_D		37	W
Input Voltage, common mode	V_{cm}		$-V_S + 50$ to $+V_S - 50$	V
Input Voltage, differential	$V_{IN(Diff)}$		± 20	V
Temperature, pin solder, 10s			+225	$^\circ\text{C}$
Temperature, junction ¹	T_J		+150	$^\circ\text{C}$
Temperature, storage		-40	+150	$^\circ\text{C}$
Operating Temperature Range, case	T_C	-40	+85	$^\circ\text{C}$

1. Long term operation at the maximum junction temperature will result in reduced product life. Derate internal power dissipation to achieve high MTTF.

INPUT

Parameter	Test Conditions	PA99			PA99A			Unit
		Min	Typ	Max	Min	Typ	Max	
Offset Voltage, initial			2.0	5.0			2.0	mV
Offset Voltage vs. temperature	Full temp range			75			50	$\mu\text{V}/^\circ\text{C}$
Offset Voltage vs. supply			0.1			*		$\mu\text{V}/\text{V}$
Bias Current, Initial ¹			50			*		pA
Bias Current vs. supply			0.01			*		pA/V
Offset Current, Initial			5.0	50		*	*	pA
Input Resistance, DC			10^{11}			*		Ω
Input Capacitance			13			*		pF
Common Mode Voltage Range			$-V_S + 50$ $+V_S - 50$			*		V
Common Mode Rejection, DC			134			*		dB
Input Noise	20 kHz BW, $R_S = 10\text{ k}\Omega$		2			*		$\mu\text{V RMS}$

1. Doubles for every 10°C of case temperature increase.

GAIN

Parameter	Test Conditions	PA99			PA99A			Unit
		Min	Typ	Max	Min	Typ	Max	
Open Loop, @ 15 Hz			117			*		dB
Gain Bandwidth Product	AV=100, 280 kHz		28			*		MHz
Power Bandwidth	V _O = 2000V, V _S = 2200V	1.6	5		*	*		kHz
Phase Margin			60			*		°
Harmonic Distortion, HD2	1 kHz		61			*		dB
Harmonic Distortion, HD3	1 kHz		56			*		dB

OUTPUT

Parameter	Test Conditions	PA99			PA99A			Unit
		Min	Typ	Max	Min	Typ	Max	
Voltage Swing, negative rail	I _O = 20mA		-Vs+20			*		V
Voltage Swing, positive rail	I _O = 20mA		+Vs-20			*		V
Current, continuous	Within SOA			±50			*	mA
Slew Rate, rising		10	30		*	*		V/μs
Slew Rate, falling		10	30		*	*		V/μs
Resistive Load		1000			*			Ω

POWER SUPPLY

Parameter	Test Conditions	PA99			PA99A			Unit
		Min	Typ	Max	Min	Typ	Max	
Voltage		±100		±1250	*		*	V
Current, quiescent			4.0			*		mA

THERMAL

Parameter	Test Conditions	PA99			PA99A			Unit
		Min	Typ	Max	Min	Typ	Max	
Resistance, DC, junction to case	Full temp range, F < 60 Hz		3.3			*		°C/W
Resistance, junction to air	Full temp range		15.4			*		°C/W

Note: An asterisk (*) in a specification column of PA99A indicates that the value is identical to the specification for the PA99 in the applicable column to the left

TYPICAL PERFORMANCE GRAPHS

Figure 3: Power Derating

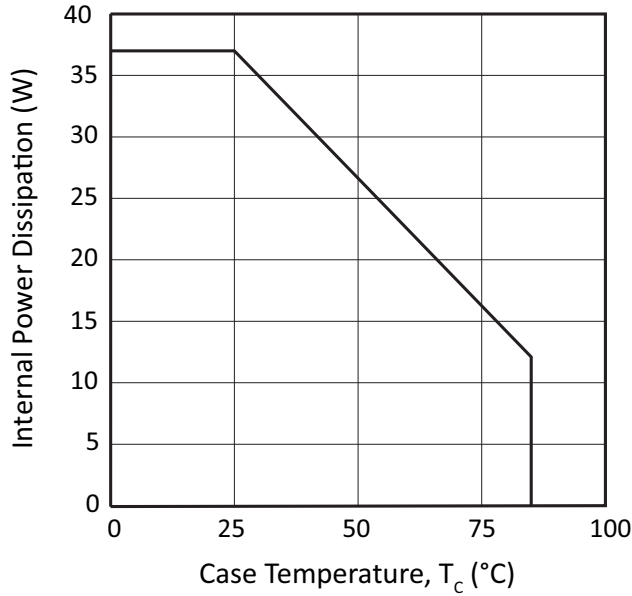

Figure 4: Large Signal Pulse Response

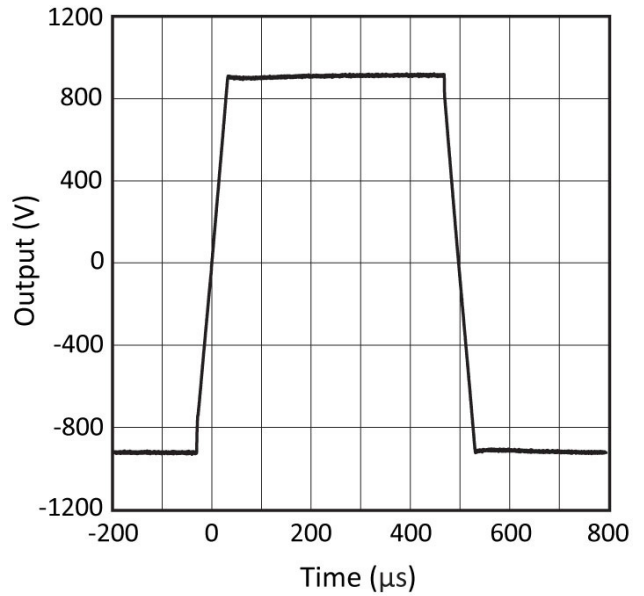

Figure 5: Small Signal Pulse Response

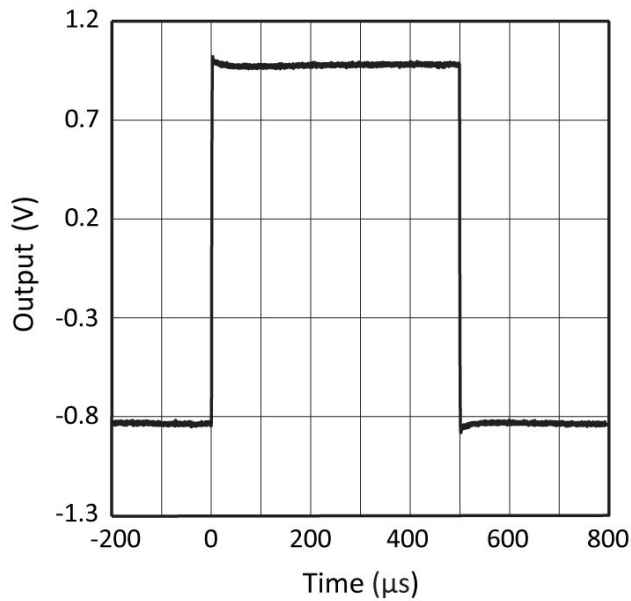

Figure 6: Large Signal Response with Current Limit

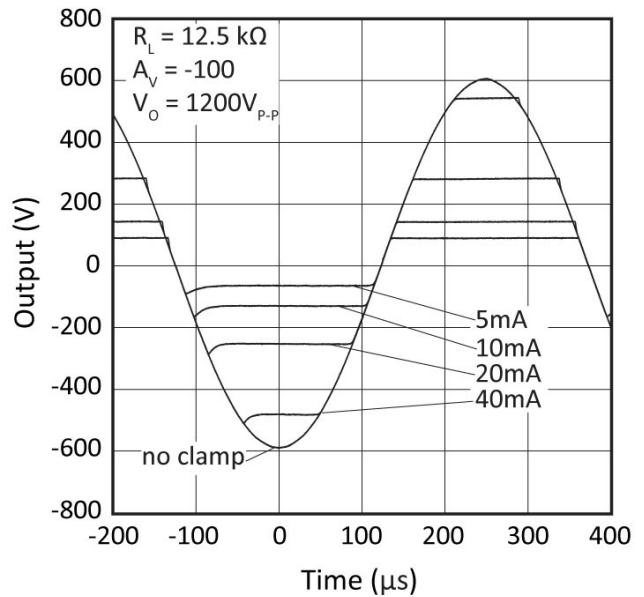

Figure 7: Open Loop Gain vs. Frequency

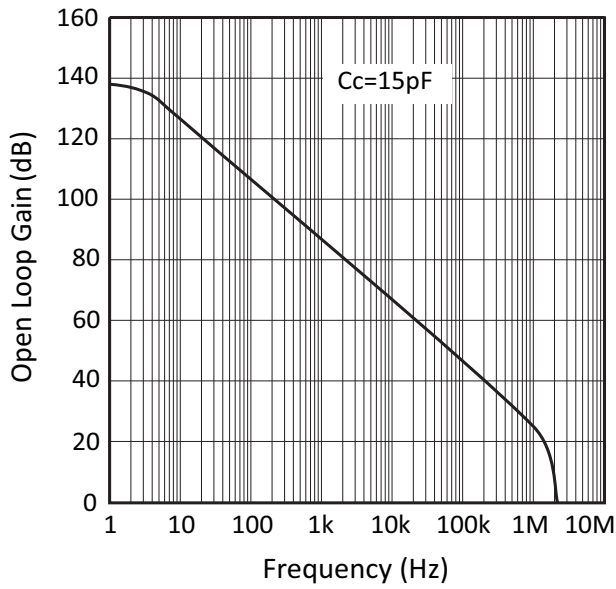

Figure 8: Phase Response

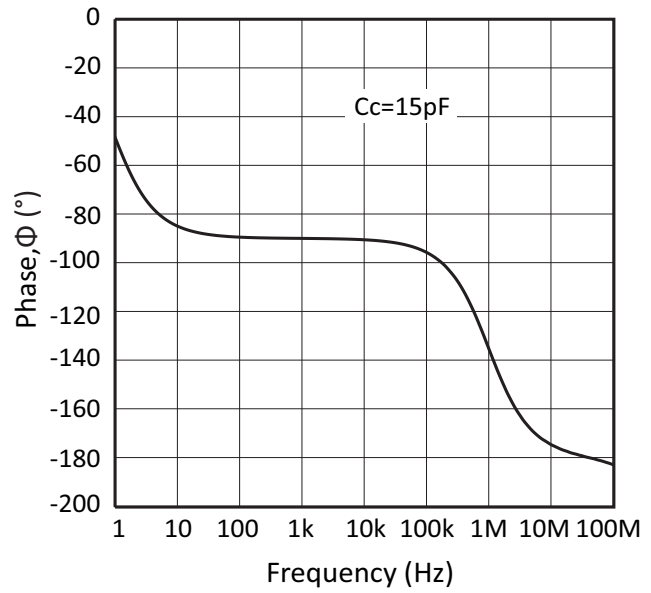

Figure 9: Common Mode Rejection vs. Frequency

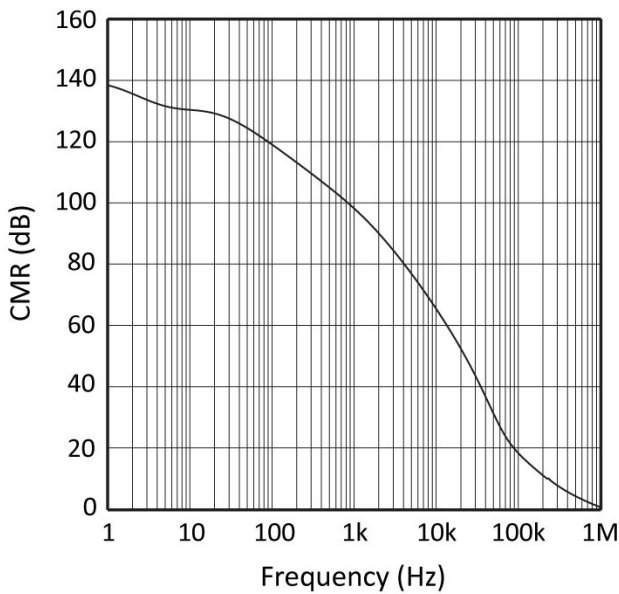

Figure 10: Power Supply Rejection

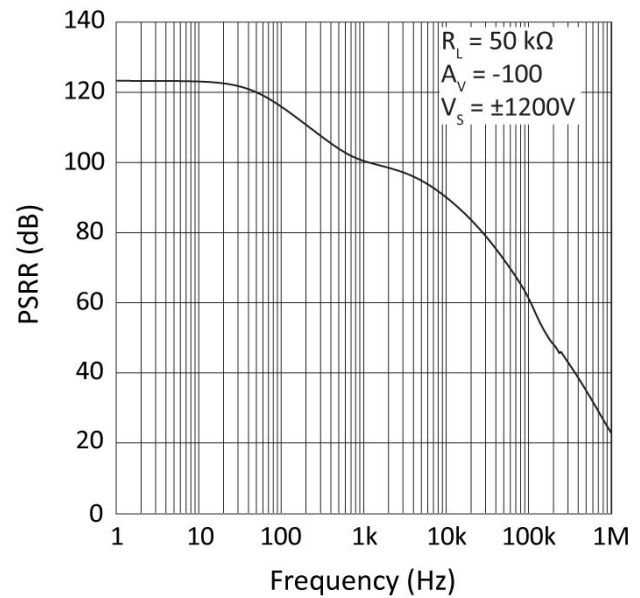

Figure 11: Quiescent Current

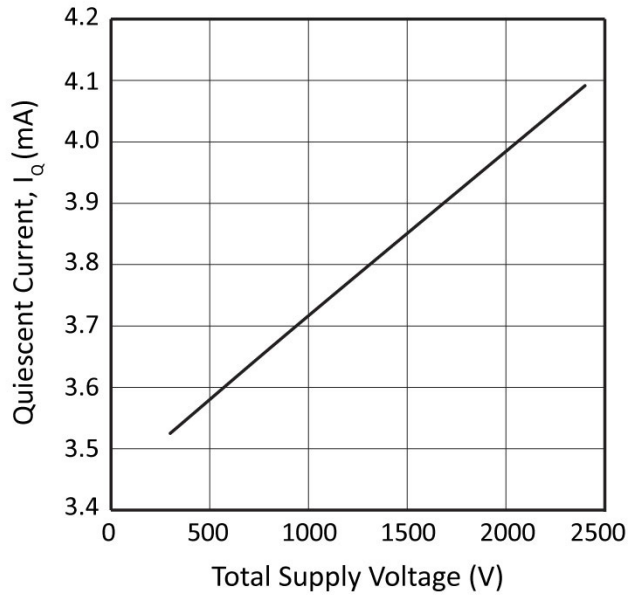

Figure 12: Output Voltage Swing

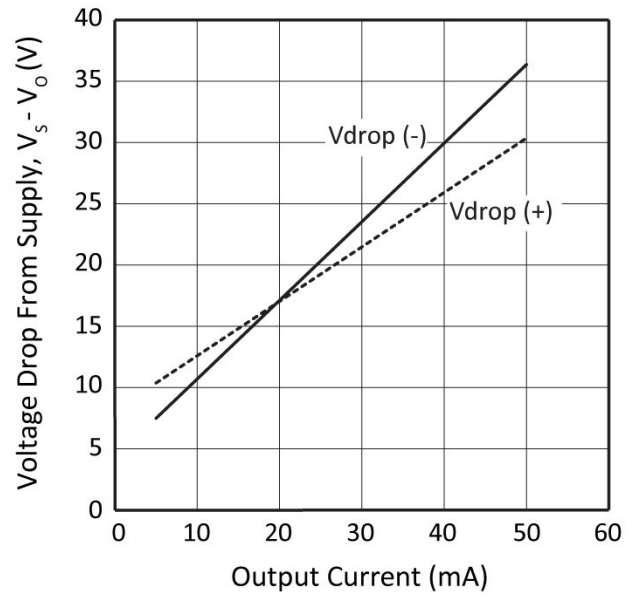

Figure 13: Input Noise vs. Frequency

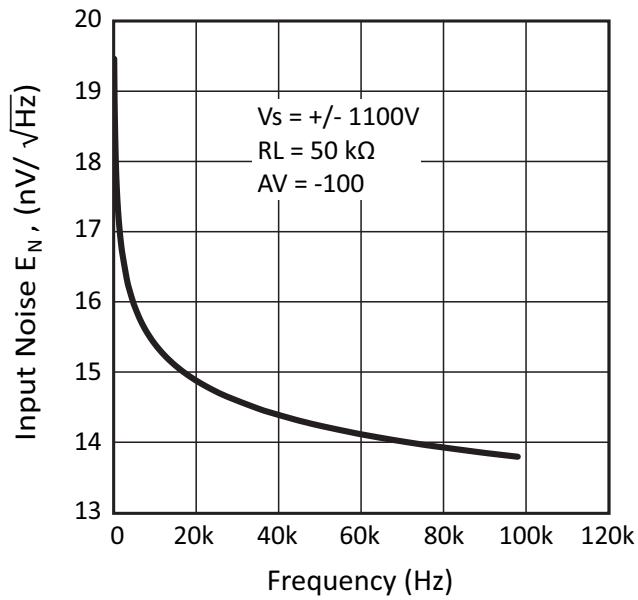

Figure 14: Negative Current Limit Resistor

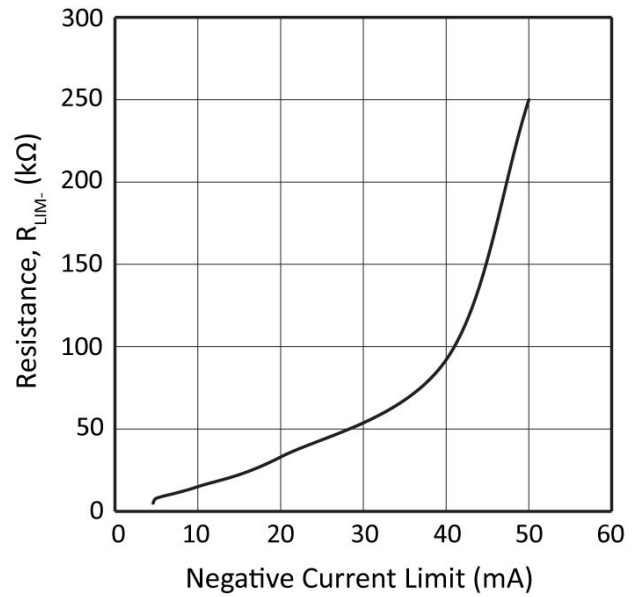

Figure 15: Slew Rate vs. Compensation

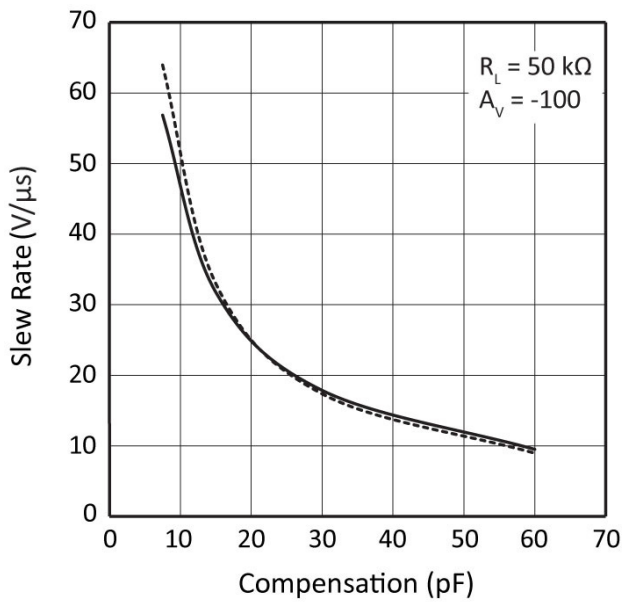

Figure 16: Harmonic Distortion

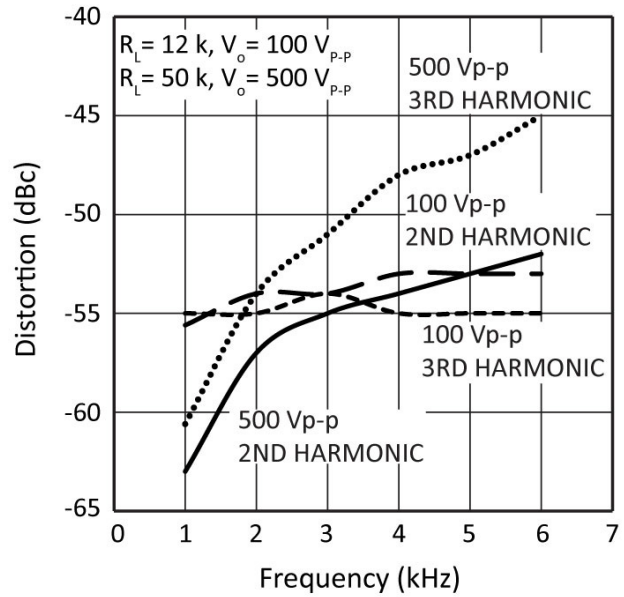

Figure 17: Temperature Diode (1mA Bias)

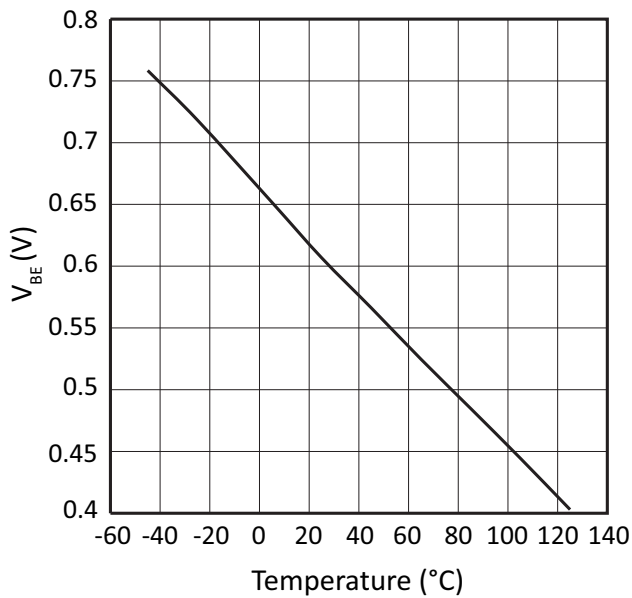
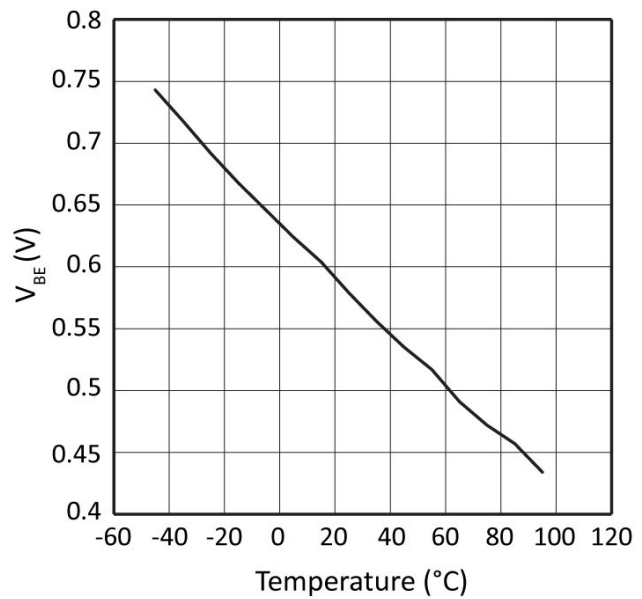
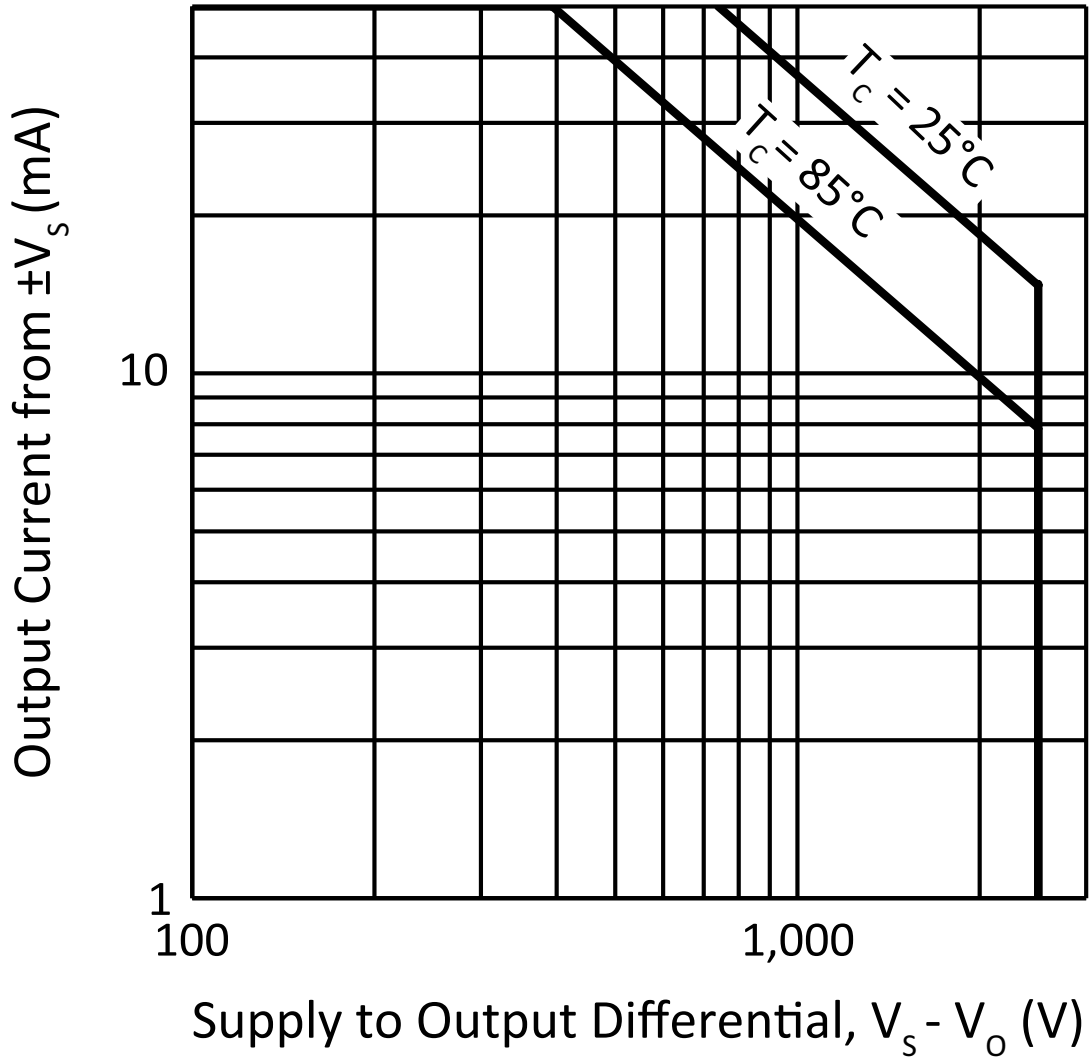

Figure 18: Temperature Diode (500μA Bias)



SAFE OPERATING AREA (SOA)

Figure 19: SOA



GENERAL

Please read Application Note 1 “General Operating Considerations” which covers stability, supplies, heat sinking, mounting, current limit, SOA interpretation, and specification interpretation. Visit www.apexanalog.com for Apex Microtechnology’s complete Application Notes library, Technical Seminar Workbook, and Evaluation Kits.

TYPICAL APPLICATION

Figure 20: Typical Application Circuit

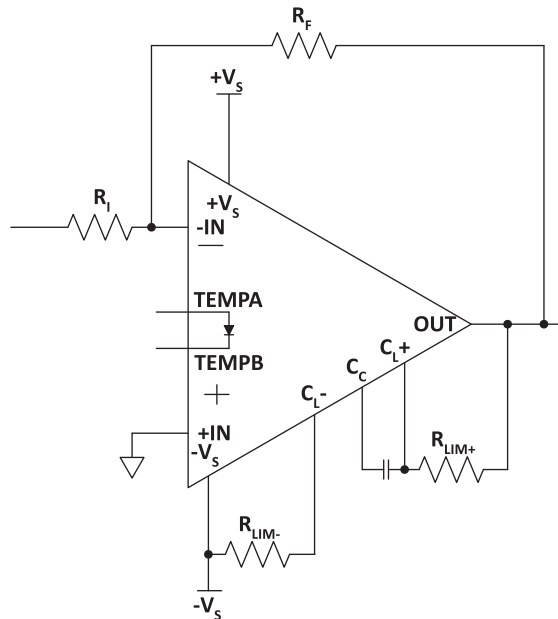

Figure 20 shows PA99 in a typical inverting amplifier circuit. The resistors R_{LIM+} and R_{LIM-} are used to limit the current output. If no current limit is desired, a direct connection between C_{L+} and OUT is required for proper operation, and C_{L-} must be connected to $-V_s$ with a resistor larger or equal 200 k Ω in that case.

OUTPUT CURRENT AND DEVICE COOLING

PA99 can handle output currents of $\pm 50mA$, but careful considerations need to be done about proper cooling of the device to avoid damage due to overheating. When calculating the power loss inside the device, the output current and the quiescent currents need to be considered.

For example, if the device uses a supply voltage of 1000V, the output voltage to a resistive load is 500V and the output current is 50mA, the power loss inside the device is calculated as follows:

$$P_{DEVICE} = (1000V - 500V) \cdot (50 + 4)mA = 27W$$

In the above example, the device will dissipate 27W of heat. If we supply 1500V instead of 1000V, the power dissipation of the device doubles, resulting in a loss of 54W.

As alternative to extensive device cooling, it should be considered to alter the supply voltage of the device. If the PA99 is used in a test environment where it needs to drive 50mA at 500V but 5mA at 2000V, consider supplying two voltages, i.e. 1000V and 2500V, and provide for sufficient cooling for the approximate 30W of power dissipation of the device.

OVERVOLTAGE PROTECTION

Although the PA99 can withstand differential input voltages up to $\pm 20V$, additional external protection is recommended. In most applications 1N4148 signal diodes connected anti-parallel across the input pins are sufficient. In more demanding applications where bias current is important diode connected JFETs such as 2N4416 will be required. In either case the differential input voltage will be clamped to $\pm 0.7V$. This is usually sufficient overdrive to produce the maximum power bandwidth.

CURRENT LIMIT

PA99 allows independent setting of a positive and negative current limit.

POSITIVE CURRENT LIMIT

The resistor value R_{LIM+} for positive current limit is calculated as follows:

$$R_{LIM}(\Omega) = \frac{0.65V}{I_{LIM}(A)}$$

Positive Current Limit	Measured Resistor Value (R_{LIM+})
5mA	130 Ω
10mA	68 Ω
20mA	32.4 Ω
40mA	15.8 Ω

NEGATIVE CURRENT LIMIT

The current limit resistor for the negative current limit can be approximated as:

$$R_{LIM}(\Omega) = 5324 \times e^{76.4 \times I_{LIM}(A)}$$

Negative Current Limit	Measured Resistor Value (R_{LIM-})
5mA	8 k Ω
10mA	15 k Ω
20mA	33 k Ω
40mA	92 k Ω

TEMPERATURE SENSING

The temperature sensing pins of the PA99 are connected to a 1N4448 type of diode that can be used to sense the temperature inside the device. A typical application will use a current source as the best means for the excitation of the diode.

PACKAGE OPTIONS

Part Number	Apex Package Style	Description
PA99	CW	12-pin Power DIP, High Voltage
PA99A	CW	12-pin Power DIP, High Voltage

PACKAGE STYLE CW

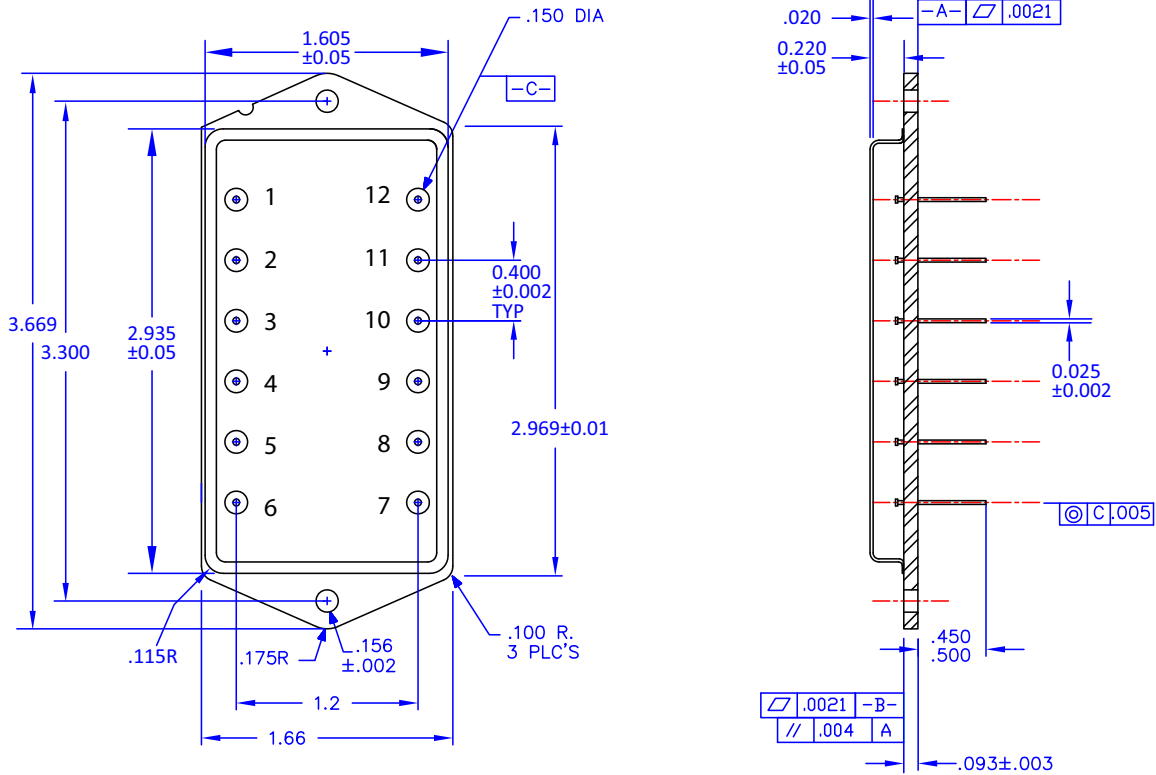

NEED TECHNICAL HELP? CONTACT APEX SUPPORT!

For all Apex Microtechnology product questions and inquiries, call toll free 800-546-2739 in North America. For inquiries via email, please contact apex.support@apexanalog.com. International customers can also request support by contacting their local Apex Microtechnology Sales Representative. To find the one nearest to you, go to www.apexanalog.com

IMPORTANT NOTICE

Apex Microtechnology, Inc. has made every effort to insure the accuracy of the content contained in this document. However, the information is subject to change without notice and is provided "AS IS" without warranty of any kind (expressed or implied). Apex Microtechnology reserves the right to make changes without further notice to any specifications or products mentioned herein to improve reliability. This document is the property of Apex Microtechnology and by furnishing this information, Apex Microtechnology grants no license, expressed or implied under any patents, mask work rights, copyrights, trademarks, trade secrets or other intellectual property rights. Apex Microtechnology owns the copyrights associated with the information contained herein and gives consent for copies to be made of the information only for use within your organization with respect to Apex Microtechnology integrated circuits or other products of Apex Microtechnology. This consent does not extend to other copying such as copying for general distribution, advertising or promotional purposes, or for creating any work for resale.

APEX MICROTECHNOLOGY PRODUCTS ARE NOT DESIGNED, AUTHORIZED OR WARRANTED TO BE SUITABLE FOR USE IN PRODUCTS USED FOR LIFE SUPPORT, AUTOMOTIVE SAFETY, SECURITY DEVICES, OR OTHER CRITICAL APPLICATIONS. PRODUCTS IN SUCH APPLICATIONS ARE UNDERSTOOD TO BE FULLY AT THE CUSTOMER OR THE CUSTOMER'S RISK.

Apex Microtechnology, Apex and Apex Precision Power are trademarks of Apex Microtechnology, Inc. All other corporate names noted herein may be trademarks of their respective holders.

Mouser Electronics

Authorized Distributor

Click to View Pricing, Inventory, Delivery & Lifecycle Information:

[Apex Microtechnology:](#)

[PA99](#) [PA99A](#)