

GloTek, Inc. www.globtek.com 186 Veterans Drive, Northvale, NJ 07647 Tel. (201) 784-1000 Fax (201) 784-0111	Drawing Title: GTM96600-6012-R2, ICT / ITE / Medical Power Supply/Class 2/Household Power Supply, Efficiency Level: USA DOE Level VI / Eco-design Directive 2009/125/EC, (EU) 2019/1782, Case Color/Style: GloTek Black, Wall Plug-in+Desktop Combination, Regulated Switchmode AC-DC Power Supply AC Adaptor, Input Rating: 100-240V~, 50-60 Hz, IEC 60320/C8 w/ Wall Blades Option , Output Rating: 60W, 12.0V@5.0A, Output Configuration: 1200 mm, 16/1C + Shield Cond, UL 1185, Female Barrel 5.5*2.1*11mm w/ Spring Clip & Locking Notch or Equal, Ferrite: Core Size: RH 14.2*28.5*10, GloTek Black, GT Cord # C4670, Pin Out: Center Positive (+V), Blades/Input Cord: R-Series Desktop Insert, Approvals: Korea (41V-54V Only); CB 60335; Fuse 60335; 230V CoC Tier 2; ETL; South Africa; EAC; cETLus 60601-1-11; cETLus 60950-1; UL 1310; CB 62368; Taiwan BSMI; India BIS; UKCA; UL 1310; cETLus 62368-1; CB 61158; NRCan (5V only); Morocco; Korea (9-15V Only); ETL 60950; S-Mark 60950; RCM; CB 60950; Double Insulation; CB 60601-1; S-Mark IEC/EN 60601-1; CCC; cETLus 60601-1; LPS 60950; PSE; PSE; PSE; CE; China RoHS; Level VI; RoHS; Ukraine; VCCI; WEEE;	
	Model No. GTM96600-6012-R2	
	Part No./Ordering No. RR9KE5000CCPCIMR6B	Rev B1

REVISION HISTORY

REV	DESCRIPTION	SUB	DATE	APPROVED
B1	Update packing to gift box with dimensions 142*62*60 mm		01/06/2020	QA
B	Update approvals: CCC, Ukraine, add approvals: Book, BIS India		09/30/2019	QA
A	Initial Release		05/02/2017	QA

In Addition to GloTek Inc.'s renewed ISO9001:2015 - Quality Management System Certification, GloTek Inc. is now certified to:

ISO13485:2016 - Medical Devices Quality Management System Certification

ISO14001:2015 - Environmental Management System Certification

ISO Certificates are available online at <https://www.globtek.com/iso-certificates/>

Customer Approval of Specification:

Please approve, sign and send back to GloTek so we can complete order processing.

A delay in receipt of this form will delay delivery schedule.

Company Name:

Customer P/N:

Quote Number:

Date:

Authorized Representative Name:

Authorized Representative Signature:

The acceptance of this specification and use of the product described in this document indicates the acceptance and binding of the customer to GloTek terms and conditions, which supersede all other agreements, terms, and conditions (<https://en.globtek.com/terms-and-conditions/>).

The purchaser of this product (Customer) agrees that it is their sole responsibility to determine suitability/fitness of the product described in this specification for their application and to take precautions for protection against any hazards attendant to the handling and use of the product.

Footnote:

GloTek Inc. will not be liable for the safety and performance of these power supplies if unauthorized access and repair occurs. End user should consult applicable UL, CSA or EN standards for proper installation instruction.

Limitation of Use:

GloTek products are intended for use with commercial, medical, and/or industrial equipment only. GloTek product are not authorized for use as mission critical components in life support hazardous environment, nuclear or aircraft applications without prior written approval from the CEO of GloTek Inc.

Contents of this document are subject to change without prior notice.

GlobTek, Inc. www.globtek.com 186 Veterans Drive, Northvale, NJ 07647 Tel. (201) 784-1000 Fax (201) 784-0111	Drawing Title: GTM96600-6012-R2, ICT / ITE / Medical Power Supply/Class 2/Household Power Supply, Efficiency Level: USA DOE Level VI / Eco-design Directive 2009/125/EC, (EU) 2019/1782, Case Color/Style: GlobTek Black, Wall Plug-in+Desktop Combination, Regulated Switchmode AC-DC Power Supply AC Adaptor, Input Rating: 100-240V~, 50-60 Hz, IEC 60320/C8 w/ Wall Blades Option , Output Rating: 60W, 12.0V@5.0A, Output Configuration: 1200 mm, 16/1C + Shield Cond, UL 1185, Female Barrel 5.5*2.1*11mm w/ Spring Clip & Locking Notch or Equal, Ferrite: Core Size: RH 14.2*28.5*10, GlobTek Black, GT Cord # C4670, Pin Out: Center Positive (+V), Blades/Input Cord: R-Series Desktop Insert, Approvals: Korea (41V-54V Only); CB 60335; Fuse 60335; 230V CoC Tier 2; ETL; South Africa; EAC; cETLus 60601-1-11; cETLus 60950-1; UL 1310; CB 62368; Taiwan BSMI; India BIS; UKCA; UL 1310; cETLus 62368-1; CB 61158; NRCAN (5V only); Morocco; Korea (9-15V Only); ETL 60950; S-Mark 60950; RCM; CB 60950; Double Insulation; CB 60601-1; S-Mark IEC/EN 60601-1; CCC; cETLus 60601-1; LPS 60950; PSE; PSE; PSE; CE; China RoHS; Level VI; RoHS; Ukraine; VCCI; WEEE;	
	Model No. GTM96600-6012-R2	
	Part No./Ordering No. RR9KE5000CCPCIMR6B	Rev B1

POWER SUPPLY INFORMATION	
TYPE:	Wall Plug-in+Desktop Combination
TECHNOLOGY:	Regulated Switchmode AC-DC Power Supply AC Adaptor
CASE COLOR:	GlobTek Black
NAMEPLATE RATED INPUT:	100-240V~, 50-60 Hz, 1.5 A
INPUT CONFIG:	IEC 60320/C8 w/ Wall Blades Option
WATTS:	60.0
VOLTS OUT:	12.0
CURRENT OUT (Amps):	5.0
BLADE/CORD INCLUDED:	R-DI R-Series Desktop Insert
BLADE/CORD INSTALLED:	R-DI :R-Series Desktop Insert
INGRESS PROTECTION:	IP40, IP54 Option available
GROUNDING CONFIGURATION:	(F1) Class II / Double Insulated
EFFICIENCY LEVEL:	USA DOE Level VI / Eco-design Directive 2009/125/EC, (EU) 2019/1782 - Europe Code of Conduct on Energy Efficiency of External Power Supplies - Version 5
OUTPUT CONFIGURATION:	1200 mm, 16/1C + Shield Cond, UL 1185, Female Barrel 5.5*2.1*11mm w/ Spring Clip & Locking Notch or Equal, Ferrite: Core Size: RH 14.2*28.5*10, GlobTek Black, GT Cord # C4670
CONNECTOR PIN OUT:	Center Positive (+V)
LABEL SPECS:	ISO 15223 medical device compliant label,L-1470
SPECIAL BARCODE LABEL	No
MATERIAL:	No
PACK SPEC:	Desktop/WPI with Desktop Insert T3, User manual
USER MANUAL:	809-PSURKITUSERMANUAL on A4 paper

GloTek, Inc. www.globtek.com 186 Veterans Drive, Northvale, NJ 07647 Tel. (201) 784-1000 Fax (201) 784-0111	Drawing Title: GTM96600-6012-R2, ICT / ITE / Medical Power Supply/Class 2/Household Power Supply, Efficiency Level: USA DOE Level VI / Eco-design Directive 2009/125/EC, (EU) 2019/1782, Case Color/Style: GlobTek Black, Wall Plug-in+Desktop Combination, Regulated Switchmode AC-DC Power Supply AC Adaptor, Input Rating: 100-240V~, 50-60 Hz, IEC 60320/C8 w/ Wall Blades Option , Output Rating: 60W, 12.0V@5.0A, Output Configuration: 1200 mm, 16/1C + Shield Cond, UL 1185, Female Barrel 5.5*2.1*11mm w/ Spring Clip & Locking Notch or Equal, Ferrite: Core Size: RH 14.2*28.5*10, GlobTek Black, GT Cord # C4670, Pin Out: Center Positive (+V), Blades/Input Cord: R-Series Desktop Insert, Approvals: Korea (41V-54V Only); CB 60335; Fuse 60335; 230V CoC Tier 2; ETL; South Africa; EAC; cETLus 60601-1-11; cETLus 60950-1; UL 1310; CB 62368; Taiwan BSMI; India BIS; UKCA; UL 1310; cETLus 62368-1; CB 61158; NRCan (5V only); Morocco; Korea (9-15V Only); ETL 60950; S-Mark 60950; RCM; CB 60950; Double Insulation; CB 60601-1; S-Mark IEC/EN 60601-1; CCC; cETLus 60601-1; LPS 60950; PSE; PSE; PSE; CE; China RoHS; Level VI; RoHS; Ukraine; VCCI; WEEE;	
	Model No. GTM96600-6012-R2	
	Part No./Ordering No. RR9KE5000CCPCIMR6B	Rev B1

Notes/Modifications/Customizations (notes in this section supersede the values shown in the standard spec):

DIMENSIONS ARE IN MM UNLESS SPECIFIED OTHERWISE.

GlobTek, Inc. www.globtek.com 186 Veterans Drive, Northvale, NJ 07647 Tel. (201) 784-1000 Fax (201) 784-0111	Drawing Title: GTM96600-6012-R2, ICT / ITE / Medical Power Supply/Class 2/Household Power Supply, Efficiency Level: USA DOE Level VI / Eco-design Directive 2009/125/EC, (EU) 2019/1782, Case Color/Style: GlobTek Black, Wall Plug-in+Desktop Combination, Regulated Switchmode AC-DC Power Supply AC Adaptor, Input Rating: 100-240V~, 50-60 Hz, IEC 60320/C8 w/ Wall Blades Option , Output Rating: 60W, 12.0V@5.0A, Output Configuration: 1200 mm, 16/1C + Shield Cond, UL 1185, Female Barrel 5.5*2.1*11mm w/ Spring Clip & Locking Notch or Equal, Ferrite: Core Size: RH 14.2*28.5*10, GlobTek Black, GT Cord # C4670, Pin Out: Center Positive (+V), Blades/Input Cord: R-Series Desktop Insert, Approvals: Korea (41V-54V Only); CB 60335; Fuse 60335; 230V CoC Tier 2; ETL; South Africa; EAC; cETLus 60601-1-11; cETLus 60950-1; UL 1310; CB 62368; Taiwan BSMI; India BIS; UKCA; UL 1310; cETLus 62368-1; CB 61158; NRCAN (5V only); Morocco; Korea (9-15V Only); ETL 60950; S-Mark 60950; RCM; CB 60950; Double Insulation; CB 60601-1; S-Mark IEC/EN 60601-1; CCC; cETLus 60601-1; LPS 60950; PSE; PSE; PSE; CE; China RoHS; Level VI; RoHS; Ukraine; VCCI; WEEE;	
	Model No. GTM96600-6012-R2	
	Part No./Ordering No. RR9KE5000CCPCIMR6B	Rev B1

ELECTRICAL SPECIFICATIONS

Input

Input Voltage:	Specified: 90-264VAC, Nameplate: 100-240VAC 100% rated load current for 90-264VAC 85% rated load current for 85-264VAC 100% rated load current for 110-370VDC
Input Frequency:	Specified: 47-63Hz, Nameplate: 50-60Hz
No Load Input Power:	<75mW @ 230VAC (EU CoC Tier 2 compliant) for ≤ 49W rating <150mW @ 230VAC (EU CoC Tier 2 compliant) for > 49W rating
Inrush Current:	30A/60A max. (cold start @ 115V/230VAC)
Efficiency:	DoE Level VI and EU CoC Tier 2 compliant

Output

Turn-on Delay:	1 second max. @ 115VAC and full load
Output Regulation:	± 5% (measured at output connector)
Line Regulation:	± 0.5% typ. (measured at output connector)
Ripple:	1% or 100mV, whichever is greater (using a 47µF low-ESR cap + 0.1µF ceramic capacitor, measured @ 20MHz BW, at output connector)
Transient Response:	5% max. deviation, 1ms typ. recovery time (with 40% to 70% load step)
Hold-up Time:	8ms typ. (nominal input voltage and full load)
Power Indicator:	Green LED

Protections

Input Protection:	MOV transient suppressor, input line fusing
Over-Current Protection:	110 - 160% of rated output current, auto-restart, current limit range determined by normal output power rating, not de-rated power rating
Short-Circuit Protection:	Auto-restart
Over-Voltage Protection:	110 - 130%, latched off, cycle AC to reset
Over-Temperature Protection:	On-chip temperature sensor (integrated in primary-side switching controller), shut down at Tj = ~140°C, latched off, cycle AC to reset

Environmental

MTBF:	1,500,000 hours @ 25°C ambient, full load (Telcordia SR-332, Issue 3)
Operating Temperature:	-20°C to 40°C (full load)
Storage Temperature:	-30°C to 80°C
Humidity:	0% to 95% relative humidity, non-condensing

GloTek, Inc. www.globtek.com 186 Veterans Drive, Northvale, NJ 07647 Tel. (201) 784-1000 Fax (201) 784-0111	Drawing Title: GTM96600-6012-R2, ICT / ITE / Medical Power Supply/Class 2/Household Power Supply, Efficiency Level: USA DOE Level VI / Eco-design Directive 2009/125/EC, (EU) 2019/1782, Case Color/Style: GlobTek Black, Wall Plug-in+Desktop Combination, Regulated Switchmode AC-DC Power Supply AC Adaptor, Input Rating: 100-240V~, 50-60 Hz, IEC 60320/C8 w/ Wall Blades Option , Output Rating: 60W, 12.0V@5.0A, Output Configuration: 1200 mm, 16/1C + Shield Cond, UL 1185, Female Barrel 5.5*2.1*11mm w/ Spring Clip & Locking Notch or Equal, Ferrite: Core Size: RH 14.2*28.5*10, GlobTek Black, GT Cord # C4670, Pin Out: Center Positive (+V), Blades/Input Cord: R-Series Desktop Insert, Approvals: Korea (41V-54V Only); CB 60335; Fuse 60335; 230V CoC Tier 2; ETL; South Africa; EAC; cETLus 60601-1-11; cETLus 60950-1; UL 1310; CB 62368; Taiwan BSMI; India BIS; UKCA; UL 1310; cETLus 62368-1; CB 61158; NRCAN (5V only); Morocco; Korea (9-15V Only); ETL 60950; S-Mark 60950; RCM; CB 60950; Double Insulation; CB 60601-1; S-Mark IEC/EN 60601-1; CCC; cETLus 60601-1; LPS 60950; PSE; PSE; PSE; CE; China RoHS; Level VI; RoHS; Ukraine; VCCI; WEEE;	
	Model No. GTM96600-6012-R2	
	Part No./Ordering No. RR9KE5000CCPCIMR6B	Rev B1

Altitude:	5000m
Cooling:	Convection
RoHS:	Complies with EU 2011/65/EU and China SJ/T 11363-2006
Note 1:	Regarding operating temperature a. See below de-rating table for output power capability at alternate temperature b. Extended low-end temperature range available as a custom option

Safety

Dielectric Withstand Voltage:	4000VAC or 5656VDC from input to output 3000VAC or 4242VDC from input to earth (Class I models only)
Touch Current:	Class I: 20µA max. Class II: 85µA max. Class II F2: 20µA max.
Earth Leakage Current	Class I: 300µA max. Class II: N/A
Means of Protection:	2 x MOPP
Output Isolation Options:	Class I: C6 or C14 inlet (output negative tied to Earth contact) Class II: C8 or C18 inlet Class II FE: C6 or C14 inlet (output isolated from Earth contact) Review isolation options by reading our white paper PSU Isolation and Identity .
Earth Continuity Test:	< 0.1Ω between earth pin (on AC inlet) and PCB termination point (Class I models only)
Compliant Standards:	See listing at end of this datasheet for specific standards

EMC

Applicable Standards:	Medical: EN60601-1-2, 4th edition Emissions: EN55032, EN61000-6-3, EN61000-6-4, CISPR11, CISPR22 Immunity: EN55024, EN61000-6-1, EN61000-6-2
Conducted Emissions:	Class B, FCC Part 15, Class B (with resistive load)
Radiated Emissions:	Class B, FCC Part 15, Class B (with resistive load)
Harmonic Current Voltage Distortion:	EN61000-3-2, Class A
Voltage Fluctuations/Flicker:	EN61000-3-3
Electrostatic Discharge (ESD) Immunity:	EN61000-4-2, 10KV contact discharge, 20KV air discharge
Radiated RF Immunity:	EN61000-4-3, 10V/m 80-1000MHz, 3V/m 1-2.7GHz, 80% 1KHz AM
EFT/Burst Immunity:	EN61000-4-4, 4KV/100kHz.
Line Surge Immunity:	EN61000-4-5, 2KV differential, 4KV common-mode
Conducted RF Immunity:	EN61000-4-6, 3VRMS, 80% 1KHz AM
Power Frequency Magnetic Field Immunity:	EN61000-4-8, 3A/m
Voltage Dip Immunity:	EN61000-4-11

Enclosure

GloTek, Inc. www.globtek.com 186 Veterans Drive, Northvale, NJ 07647 Tel. (201) 784-1000 Fax (201) 784-0111	Drawing Title: GTM96600-6012-R2, ICT / ITE / Medical Power Supply/Class 2/Household Power Supply, Efficiency Level: USA DOE Level VI / Eco-design Directive 2009/125/EC, (EU) 2019/1782, Case Color/Style: GlobTek Black, Wall Plug-in+Desktop Combination, Regulated Switchmode AC-DC Power Supply AC Adaptor, Input Rating: 100-240V~, 50-60 Hz, IEC 60320/C8 w/ Wall Blades Option , Output Rating: 60W, 12.0V@5.0A, Output Configuration: 1200 mm, 16/1C + Shield Cond, UL 1185, Female Barrel 5.5*2.1*11mm w/ Spring Clip & Locking Notch or Equal, Ferrite: Core Size: RH 14.2*28.5*10, GlobTek Black, GT Cord # C4670, Pin Out: Center Positive (+V), Blades/Input Cord: R-Series Desktop Insert, Approvals: Korea (41V-54V Only); CB 60335; Fuse 60335; 230V CoC Tier 2; ETL; South Africa; EAC; cETLus 60601-1-11; cETLus 60950-1; UL 1310; CB 62368; Taiwan BSMI; India BIS; UKCA; UL 1310; cETLus 62368-1; CB 61158; NRCan (5V only); Morocco; Korea (9-15V Only); ETL 60950; S-Mark 60950; RCM; CB 60950; Double Insulation; CB 60601-1; S-Mark IEC/EN 60601-1; CCC; cETLus 60601-1; LPS 60950; PSE; PSE; PSE; CE; China RoHS; Level VI; RoHS; Ukraine; VCCI; WEEE;	
	Model No. GTM96600-6012-R2	
	Part No./Ordering No. RR9KE5000CCPCIMR6B	Rev B1

Housing:	High impact plastic, 94V0 polycarbonate, non-vented
AC Input Mechanical Options:	Desktop: C6, C7, C14, or C18 inlet Hybrid: Desktop inlet or changeable blades for wall-plug-in style, Class I or Class II input
Markings:	Label and/or pad printed and/or laser-etched into case

Special Options

1. Removal of LED (cost reduction or aesthetic purpose)
2. Custom cordsets, various cordage types, and connector types
3. Custom markings
4. Short term output surge capability for motors or other high peak current loads. (Available up to 120W for 1 second at nameplate voltage range. Higher levels possible for limited input voltage range, or larger allowed voltage dip.)
5. Reduced leakage current
6. Tightened output voltage tolerance
7. Reduced output ripple level
8. Reduced output power rating
9. High reliability PCB laminate with plated through-holes for IPC610 Class 2 compliance
10. Low temperature option, down to -40°C
11. Special housing and cordset colors
12. "Back EMF" upgrade, for motor loads and other high inductance applications with reverse energy flow requirements
13. Improved ingress protection (IP) rating

Output Connectors

- Several output connector options are available with various output current ratings. GloTek can supply 10A rated 2.1mm and 2.5mm style DC Power Jacks, to complement our 10A output rated 2.1mm and 2.5mm DC power plugs used on our output cordsets.
- Please visit our real-time listing of mating connector product offering:
<https://en.globtek.com/news/high-current-coaxial-barrel-plug-jacks-for-high-wattage-power-supplies>

TO ADDRESS SYSTEM-LEVEL EMI CONCERNS, FERRITE CHOKES/BEADS MAY BE ADDED/REVISED UPON REQUEST. A SAMPLE KIT OF GLOBTEK'S STANDARD FERRITES IS AVAILABLE UNDER GLOBTEK P/N: EMI-MITIGATION-KIT1

FOR ADDITIONAL INFORMATION, PLEASE READ OUR WHITE PAPER AT:

<https://en.globtek.com/technical-articles/ferrite-kit-radiated-emi-suppression-kit-for-globtek-power-supplies-cable-assemblies>

INGRESS PROTECTION: IP40, IP54 Option available

GlobTek, Inc.
 www.globtek.com
 186 Veterans Drive,
 Northvale, NJ 07647
 Tel. (201) 784-1000
 Fax (201) 784-0111

Drawing Title: GTM96600-6012-R2, ICT / ITE / Medical Power Supply/Class 2/Household Power Supply, Efficiency Level: USA DOE Level VI / Eco-design Directive 2009/125/EC, (EU) 2019/1782, Case Color/Style: GlobTek Black, Wall Plug-in+Desktop Combination, Regulated Switchmode AC-DC Power Supply AC Adaptor, Input Rating: 100-240V~, 50-60 Hz, IEC 60320/C8 w/ Wall Blades Option , Output Rating: 60W, 12.0V@5.0A, Output Configuration: 1200 mm, 16/1C + Shield Cond, UL 1185, Female Barrel 5.5*2.1*11mm w/ Spring Clip & Locking Notch or Equal, Ferrite: Core Size: RH 14.2*28.5*10, GlobTek Black, GT Cord # C4670, Pin Out: Center Positive (+V), Blades/Input Cord: R-Series Desktop Insert, Approvals: Korea (41V-54V Only); CB 60335; Fuse 60335; 230V CoC Tier 2; ETL; South Africa; EAC; cETLus 60601-1-11; cETLus 60950-1; UL 1310; CB 62368; Taiwan BSMI; India BIS; UKCA; UL 1310; cETLus 62368-1; CB 61158; NRCAN (5V only); Morocco; Korea (9-15V Only); ETL 60950; S-Mark 60950; RCM; CB 60950; Double Insulation; CB 60601-1; S-Mark IEC/EN 60601-1; CCC; cETLus 60601-1; LPS 60950; PSE; PSE; PSE; CE; China RoHS; Level VI; RoHS; Ukraine; VCCI; WEEE;

Model No. GTM96600-6012-R2

Part No./Ordering No. RR9KE5000CCPCIMR6B

Rev B1

3D File Download <https://www.globtek.com/dl/GTM96600-R2.igs>

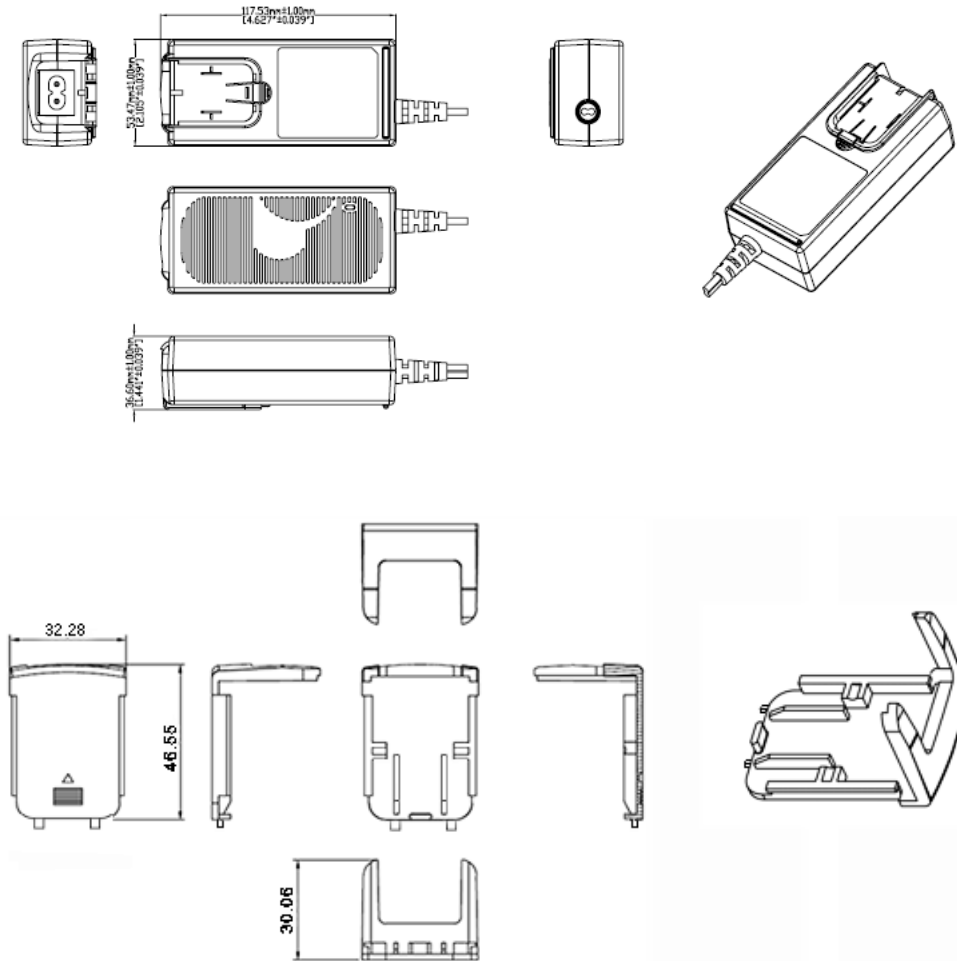

Unit shipped without an installed input plug.
 "Desktop insert" installed.

<p>GlobTek, Inc. www.globtek.com 186 Veterans Drive, Northvale, NJ 07647 Tel. (201) 784-1000 Fax (201) 784-0111</p>	<p>Drawing Title: GTM96600-6012-R2, ICT / ITE / Medical Power Supply/Class 2/Household Power Supply, Efficiency Level: USA DOE Level VI / Eco-design Directive 2009/125/EC, (EU) 2019/1782, Case Color/Style: GlobTek Black, Wall Plug-in+Desktop Combination, Regulated Switchmode AC-DC Power Supply AC Adaptor, Input Rating: 100-240V~, 50-60 Hz, IEC 60320/C8 w/ Wall Blades Option , Output Rating: 60W, 12.0V@5.0A, Output Configuration: 1200 mm, 16/1C + Shield Cond, UL 1185, Female Barrel 5.5*2.1*11mm w/ Spring Clip & Locking Notch or Equal, Ferrite: Core Size: RH 14.2*28.5*10, GlobTek Black, GT Cord # C4670, Pin Out: Center Positive (+V), Blades/Input Cord: R-Series Desktop Insert, Approvals: Korea (41V-54V Only); CB 60335; Fuse 60335; 230V CoC Tier 2; ETL; South Africa; EAC; cETLus 60601-1-11; cETLus 60950-1; UL 1310; CB 62368; Taiwan BSMI; India BIS; UKCA; UL 1310; cETLus 62368-1; CB 61158; NRCan (5V only); Morocco; Korea (9-15V Only); ETL 60950; S-Mark 60950; RCM; CB 60950; Double Insulation; CB 60601-1; S-Mark IEC/EN 60601-1; CCC; cETLus 60601-1; LPS 60950; PSE; PSE; PSE; CE; China RoHS; Level VI; RoHS; Ukraine; VCCI; WEEE;</p>	
	<p>Model No. GTM96600-6012-R2</p>	
	<p>Part No./Ordering No. RR9KE5000CCPCIMR6B</p>	<p>Rev B1</p>

DERATING CURVE

TYPICAL EXTERNAL POWER SUPPLY
DERATING CURVE
(FOR EFFICIENCY LEVEL V AND EFFICIENCY LEVEL VI PRODUCTS)

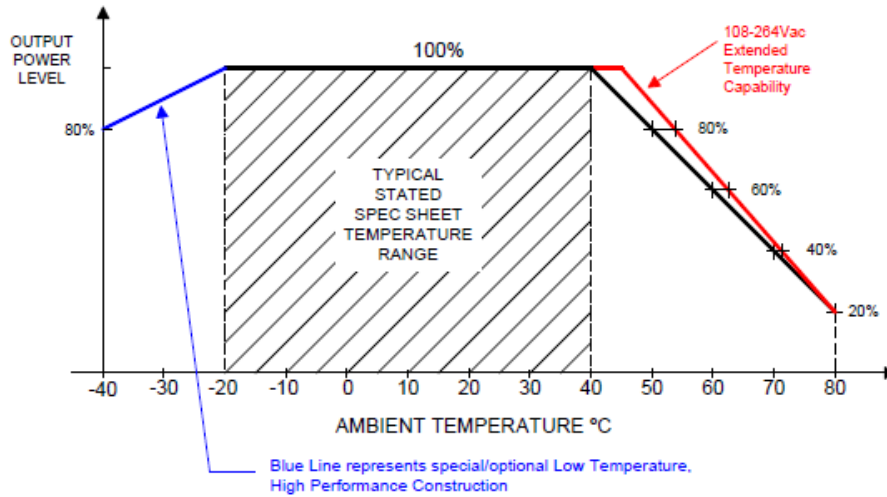

<p>GlobTek, Inc. www.globtek.com 186 Veterans Drive, Northvale, NJ 07647 Tel. (201) 784-1000 Fax (201) 784-0111</p>	<p>Drawing Title: GTM96600-6012-R2, ICT / ITE / Medical Power Supply/Class 2/Household Power Supply, Efficiency Level: USA DOE Level VI / Eco-design Directive 2009/125/EC, (EU) 2019/1782, Case Color/Style: GlobTek Black, Wall Plug-in+Desktop Combination, Regulated Switchmode AC-DC Power Supply AC Adaptor, Input Rating: 100-240V~, 50-60 Hz, IEC 60320/C8 w/ Wall Blades Option , Output Rating: 60W, 12.0V@5.0A, Output Configuration: 1200 mm, 16/1C + Shield Cond, UL 1185, Female Barrel 5.5*2.1*11mm w/ Spring Clip & Locking Notch or Equal, Ferrite: Core Size: RH 14.2*28.5*10, GlobTek Black, GT Cord # C4670, Pin Out: Center Positive (+V), Blades/Input Cord: R-Series Desktop Insert, Approvals: Korea (41V-54V Only); CB 60335; Fuse 60335; 230V CoC Tier 2; ETL; South Africa; EAC; cETLus 60601-1-11; cETLus 60950-1; UL 1310; CB 62368; Taiwan BSMI; India BIS; UKCA; UL 1310; cETLus 62368-1; CB 61158; NRCan (5V only); Morocco; Korea (9-15V Only); ETL 60950; S-Mark 60950; RCM; CB 60950; Double Insulation; CB 60601-1; S-Mark IEC/EN 60601-1; CCC; cETLus 60601-1; LPS 60950; PSE; PSE; PSE; CE; China RoHS; Level VI; RoHS; Ukraine; VCCI; WEEE;</p>	
	<p>Model No. GTM96600-6012-R2</p>	
	<p>Part No./Ordering No. RR9KE5000CCPCIMR6B</p>	<p>Rev B1</p>

INPUT CONFIGURATION

(F1) Class II / Double Insulated



[Alternate grounding configurations](#) available upon request.

Blades/Cord Included:R-DI:R-Series Desktop Insert

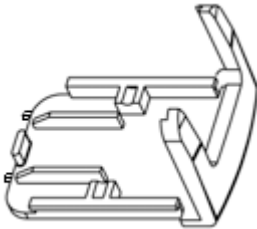

Desktop Insert Installed

Blades/Cord Installed:R-DI:R-Series Desktop Insert

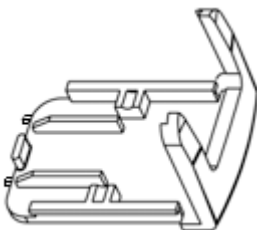

Desktop Insert Installed

IEC 60320/C8 AC Inlet connector

[Blade Insertion Instructions](#)
[R-Blade Style Instruction Video](#)

GloTek, Inc. www.globtek.com 186 Veterans Drive, Northvale, NJ 07647 Tel. (201) 784-1000 Fax (201) 784-0111	Drawing Title: GTM96600-6012-R2, ICT / ITE / Medical Power Supply/Class 2/Household Power Supply, Efficiency Level: USA DOE Level VI / Eco-design Directive 2009/125/EC, (EU) 2019/1782, Case Color/Style: GlobTek Black, Wall Plug-in+Desktop Combination, Regulated Switchmode AC Power Supply AC Adaptor, Input Rating: 100-240V~, 50-60 Hz, IEC 60320/C8 w/ Wall Blades Option , Output Rating: 60W, 12.0V@5.0A, Output Configuration: 1200 mm, 16/1C + Shield Cond, UL 1185, Female Barrel 5.5*2.1*11mm w/ Spring Clip & Locking Notch or Equal, Ferrite: Core Size: RH 14.2*28.5*10, GlobTek Black, GT Cord # C4670, Pin Out: Center Positive (+V), Blades/Input Cord: R-Series Desktop Insert, Approvals: Korea (41V-54V Only); CB 60335; Fuse 60335; 230V CoC Tier 2; ETL; South Africa; EAC; cETLus 60601-1-11; cETLus 60950-1; UL 1310; CB 62368; Taiwan BSMI; India BIS; UKCA; UL 1310; cETLus 62368-1; CB 61158; NRCan (5V only); Morocco; Korea (9-15V Only); ETL 60950; S-Mark 60950; RCM; CB 60950; Double Insulation; CB 60601-1; S-Mark IEC/EN 60601-1; CCC; cETLus 60601-1; LPS 60950; PSE; PSE; PSE; CE; China RoHS; Level VI; RoHS; Ukraine; VCCI; WEEE;	
	Model No. GTM96600-6012-R2	
	Part No./Ordering No. RR9KE5000CCPCIMR6B	Rev B1

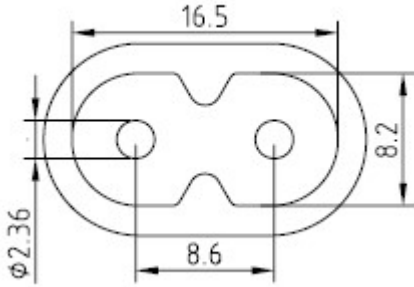

Mates with IEC 60320/C8 Plug

This series of Interchangeable Blade products may be used with Proprietary Interchangeable Blades as described below or with standard international power cords.

Optional INPUT BLADES: R-Socket: below are available blades configurations which are "not included" (unless stated above); may be purchased separately, packaged with power supply, or as a separate "R-KIT" if specified

1. Class II model NEMA 1-15P AC power plug with 2 prongs, R-NA-2(R)
2. Australian AS 3112 configuration: SAA 2 pins Class II, R-SAA-2(R)
3. UK BS 1363 configuration: UK 2 pins (dummy Ground) Class II, R-UK-2(R)
4. European CEE 7/16 configuration: Europlug 2 PINS, Class II, R-EU-2(R)
5. China GB 2099 configuration: 2 blades, Class II; CN P/N:R-CN-2(R)
6. Desktop Insert

Kits

05. R-KIT-2(R): 1,2,3,4 above

06. R-KIT-2-INTL(R): 2,3,4 above

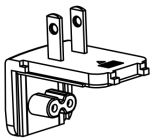

UL 2P

P/N: R-NA-2(R)
NORTH AMERICA
JAPAN

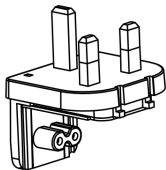

UK 2P

P/N: R-UK-2(R)
UNITED KINGDOM
HONG KONG
SINGAPORE

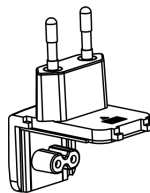

EU 2P

P/N: R-EU-2(R)
EUROPE
SOUTH AMERICA

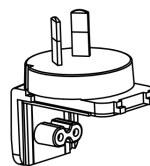

AUS 2P

P/N: R-SAA-2(R)
AUSTRALIA

Standard Cordsets

Below are standard cordsets which are "not included" (unless stated above); these may be purchased separately or packaged with the power supply. Contact your Sales Engineer if the style required is not shown below. Many more available in different lengths, colors or cable material.

[Standard International IEC 320/C7 Cordsets](#)

PROPRIETARY INFORMATION

PROPRIETARY OF GLOBTEK, INC. ANY REPRODUCTION, DISCLOSURE OR USE OF THIS DRAWING, IN WHOLE OR IN PART, IS HEREBY PROHIBITED EXCEPT AS SPECIFIED IN Page 10 of 18

WRITING BY GLOBTEK, INC. © GlobTek, Inc. 2017 - 2021

quest /08/30/2021 11:19:08 AM

GlobTek, Inc. www.globtek.com 186 Veterans Drive, Northvale, NJ 07647 Tel. (201) 784-1000 Fax (201) 784-0111	Drawing Title: GTM96600-6012-R2, ICT / ITE / Medical Power Supply/Class 2/Household Power Supply, Efficiency Level: USA DOE Level VI / Eco-design Directive 2009/125/EC, (EU) 2019/1782, Case Color/Style: GlobTek Black, Wall Plug-in+Desktop Combination, Regulated Switchmode AC-DC Power Supply AC Adaptor, Input Rating: 100-240V~, 50-60 Hz, IEC 60320/C8 w/ Wall Blades Option , Output Rating: 60W, 12.0V@5.0A, Output Configuration: 1200 mm, 16/1C + Shield Cond, UL 1185, Female Barrel 5.5*2.1*11mm w/ Spring Clip & Locking Notch or Equal, Ferrite: Core Size: RH 14.2*28.5*10, GlobTek Black, GT Cord # C4670, Pin Out: Center Positive (+V), Blades/Input Cord: R-Series Desktop Insert, Approvals: Korea (41V-54V Only); CB 60335; Fuse 60335; 230V CoC Tier 2; ETL; South Africa; EAC; cETLus 60601-1-11; cETLus 60950-1; UL 1310; CB 62368; Taiwan BSMI; India BIS; UKCA; UL 1310; cETLus 62368-1; CB 61158; NRCan (5V only); Morocco; Korea (9-15V Only); ETL 60950; S-Mark 60950; RCM; CB 60950; Double Insulation; CB 60601-1; S-Mark IEC/EN 60601-1; CCC; cETLus 60601-1; LPS 60950; PSE; PSE; PSE; CE; China RoHS; Level VI; RoHS; Ukraine; VCCI; WEEE;	
	Model No. GTM96600-6012-R2	
	Part No./Ordering No. RR9KE5000CCPCIMR6B	Rev B1

Part Number	Country	Plug	Connector	Length (mm)	Length (feet)
2094112M703(R)	Argentina (Type I)	IRAM 2063	IEC 320/C7	2000	7
5014112M703A(R)	Australian (Type I)	AS 3112	IEC 320/C7	2000	7
207B4111M8703(R)	Brazil (Type N)	NBR14136	IEC 320/C7	1800	6
4533501M8703(R)	China (Type A)	GB 2099.1	IEC 320/C7	1830	6
2074112M703A(R)	European (Type C)	CEE 7/16	IEC 320/C7	2000	7
2084111M8703(R)	South Africa (Type M)	BS 546	IEC 320/C7	1800	6
2084111M8703B(R)	India (Type D)	ISI:1293	IEC 320/C7	1800	6
2714111M8703A(R)	India (Type C)	ISI:1293	IEC 320/C7	1800	6
451J3401M8703(R)	Japan (Type A)	JIS 8303	IEC 320/C7	1830	6
2044112M703A(R)	Korea (Type C)	KS C8305	IEC 320/C7	2000	7
4511116F703A(R)	N. American (Type A)	NEMA 1-15P	IEC 320/C7	1830	6
4033401M8703A(R)	Taiwan (Type A)	CNS690	IEC 320/C7	1830	6
6104112M703A(R)	UK, Hong Kong, Singapore, Gulf States (Type G)	BS1363	IEC 320/C7	2000	7

GlobTek, Inc. www.globtek.com 186 Veterans Drive, Northvale, NJ 07647 Tel. (201) 784-1000 Fax (201) 784-0111	Drawing Title: GTM96600-6012-R2, ICT / ITE / Medical Power Supply/Class 2/Household Power Supply, Efficiency Level: USA DOE Level VI / Eco-design Directive 2009/125/EC, (EU) 2019/1782, Case Color/Style: GlobTek Black, Wall Plug-in+Desktop Combination, Regulated Switchmode AC-DC Power Supply AC Adaptor, Input Rating: 100-240V~, 50-60 Hz, IEC 60320/C8 w/ Wall Blades Option , Output Rating: 60W, 12.0V@5.0A, Output Configuration: 1200 mm, 16/1C + Shield Cond, UL 1185, Female Barrel 5.5*2.1*11mm w/ Spring Clip & Locking Notch or Equal, Ferrite: Core Size: RH 14.2*28.5*10, GlobTek Black, GT Cord # C4670, Pin Out: Center Positive (+V), Blades/Input Cord: R-Series Desktop Insert, Approvals: Korea (41V-54V Only); CB 60335; Fuse 60335; 230V CoC Tier 2; ETL; South Africa; EAC; cETLus 60601-1-11; cETLus 60950-1; UL 1310; CB 62368; Taiwan BSMI; India BIS; UKCA; UL 1310; cETLus 62368-1; CB 61158; NRCan (5V only); Morocco; Korea (9-15V Only); ETL 60950; S-Mark 60950; RCM; CB 60950; Double Insulation; CB 60601-1; S-Mark IEC/EN 60601-1; CCC; cETLus 60601-1; LPS 60950; PSE; PSE; PSE; CE; China RoHS; Level VI; RoHS; Ukraine; VCCI; WEEE;	
	Model No. GTM96600-6012-R2	
	Part No./Ordering No. RR9KE5000CCPCIMR6B	Rev B1

OUTPUT CORD AND CONNECTOR: CL1/C4670

ACTUAL CONNECTORS, OVERMOLDS, FERRITES MAY VARY SLIGHTLY FROM THE PICTURE BELOW

CABLE TYPE	UL 1185
CABLE LENGTH (mm)	1200
CABLE TOLERANCE (mm)	+150, -0
WIRE GAUGE (AWG)	16
CONDUCTORS	1C + Shield
HANK DIMENSION (mm)	80 ± 10
CABLE / CONNECTOR OVERMOLD COLOR	GlobTek Black
FERRITE TYPE / DIMENSION	Core Size: RH 14.2*28.5*10
FERRITE # OF TURNS (Definition)	2 Pass thru core (1 turns)
FERRITE DIMENSION FROM STRAIN RELIEF	50±10 mm
FERRITE DIMENSION FROM PLUG	N/A
PLUG TYPE	Female Barrel 5.5*2.1*11mm w/ Spring Clip & Locking Notch or Equal
OUTPUT CONNECTOR GENDER	
OVERMOLDED	
OVER MOLD ORIENTATION	Straight
CONNECTOR PIN OUT:	Center Positive (+V)
ADDITIONAL REQUIREMENTS	UL1310 Warning Label Up To 36 Volts with plugs

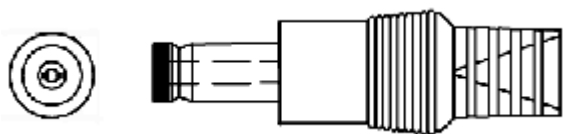

ADDITIONAL OUTPUT PLUG OPTIONS ARE AVAILABLE AT <https://www.globtek.com/connectors/>
 STANDARD PLUGS AND CONNECTORS CAN BE SEEN ONLINE AT <https://www.globtek.com/connectors/>
 CALCULATE VOLTAGE REGULATION/DROP WITH OUR ONLINE CALCULATOR: <https://en.globtek.com/output-cable-regulation-calculator/>

<p>GlobTek, Inc. www.globtek.com 186 Veterans Drive, Northvale, NJ 07647 Tel. (201) 784-1000 Fax (201) 784-0111</p>	<p>Drawing Title: GTM96600-6012-R2, ICT / ITE / Medical Power Supply/Class 2/Household Power Supply, Efficiency Level: USA DOE Level VI / Eco-design Directive 2009/125/EC, (EU) 2019/1782, Case Color/Style: GlobTek Black, Wall Plug-in+Desktop Combination, Regulated Switchmode AC-DC Power Supply AC Adaptor, Input Rating: 100-240V~, 50-60 Hz, IEC 60320/C8 w/ Wall Blades Option , Output Rating: 60W, 12.0V@5.0A, Output Configuration: 1200 mm, 16/1C + Shield Cond, UL 1185, Female Barrel 5.5*2.1*11mm w/ Spring Clip & Locking Notch or Equal, Ferrite: Core Size: RH 14.2*28.5*10, GlobTek Black, GT Cord # C4670, Pin Out: Center Positive (+V), Blades/Input Cord: R-Series Desktop Insert, Approvals: Korea (41V-54V Only); CB 60335; Fuse 60335; 230V CoC Tier 2; ETL; South Africa; EAC; cETLus 60601-1-11; cETLus 60950-1; UL 1310; CB 62368; Taiwan BSMI; India BIS; UKCA; UL 1310; cETLus 62368-1; CB 61158; NRCan (5V only); Morocco; Korea (9-15V Only); ETL 60950; S-Mark 60950; RCM; CB 60950; Double Insulation; CB 60601-1; S-Mark IEC/EN 60601-1; CCC; cETLus 60601-1; LPS 60950; PSE; PSE; PSE; CE; China RoHS; Level VI; RoHS; Ukraine; VCCI; WEEE;</p>
	<p>Model No. GTM96600-6012-R2</p>
	<p>Part No./Ordering No. RR9KE5000CCPCIMR6B</p>
	<p>Rev B1</p>

OUTPUT CONNECTOR HOOK UP

TO ADDRESS SYSTEM-LEVEL EMI CONCERNS, FERRITE CHOKES/BEADS MAY BE ADDED/REVISED UPON REQUEST. A SAMPLE KIT OF GLOBTEK'S STANDARD FERRITES IS AVAILABLE UNDER GLOBTEK P/N: EMI-MITIGATION-KIT1

FOR ADDITIONAL INFORMATION, PLEASE READ OUR WHITE PAPER AT:

<https://en.globtek.com/technical-articles/ferrite-kit-radiated-emi-suppression-kit-for-globtek-power-supplies-cable-assemblies>

GlobTek, Inc. www.globtek.com 186 Veterans Drive, Northvale, NJ 07647 Tel. (201) 784-1000 Fax (201) 784-0111	Drawing Title: GTM96600-6012-R2, ICT / ITE / Medical Power Supply/Class 2/Household Power Supply, Efficiency Level: USA DOE Level VI / Eco-design Directive 2009/125/EC, (EU) 2019/1782, Case Color/Style: GlobTek Black, Wall Plug-in+Desktop Combination, Regulated Switchmode AC-DC Power Supply AC Adaptor, Input Rating: 100-240V~, 50-60 Hz, IEC 60320/C8 w/ Wall Blades Option , Output Rating: 60W, 12.0V@5.0A, Output Configuration: 1200 mm, 16/1C + Shield Cond, UL 1185, Female Barrel 5.5*2.1*11mm w/ Spring Clip & Locking Notch or Equal, Ferrite: Core Size: RH 14.2*28.5*10, GlobTek Black, GT Cord # C4670, Pin Out: Center Positive (+V), Blades/Input Cord: R-Series Desktop Insert, Approvals: Korea (41V-54V Only); CB 60335; Fuse 60335; 230V CoC Tier 2; ETL; South Africa; EAC; cETLus 60601-1-11; cETLus 60950-1; UL 1310; CB 62368; Taiwan BSMI; India BIS; UKCA; UL 1310; cETLus 62368-1; CB 61158; NRCAN (5V only); Morocco; Korea (9-15V Only); ETL 60950; S-Mark 60950; RCM; CB 60950; Double Insulation; CB 60601-1; S-Mark IEC/EN 60601-1; CCC; cETLus 60601-1; LPS 60950; PSE; PSE; PSE; CE; China RoHS; Level VI; RoHS; Ukraine; VCCI; WEEE;
	Model No. GTM96600-6012-R2
	Part No./Ordering No. RR9KE5000CCPCIMR6B Rev B1

LABEL:L-1470

LABEL P/N:	ISO 15223 medical device compliant label
MATERIAL:	Flat Thermal Transfer, Imprintable, Polyester Label and/or Pad Printed and/or Molded, and/or Laser Engraved in the case
BACKGROUND COLOR:	Black if housing is Black, White or Silver if housing is White or Gray.
TEXT COLOR:	White or Silver if label is Black Background for Black housing. Black if label is White or Silver background and Housing is White or Gray.
LABEL WIDTH (mm):	44.5
LABEL HEIGHT (mm):	49.5
SPECIAL BARCODE LABEL MATERIAL:	No

Below is the minimum information which will appear on the label. NOTE: in the logo area additional/actual positioning of symbols and text is subjected to change as per agency updates/requirements or additional model approvals become available. Agency logos may be in Regulatory Certifications/Label Markings area on the label or molded into the case housing outside the label area. Information will be shown via Label and/or Pad Printed and/or Molded in the case.

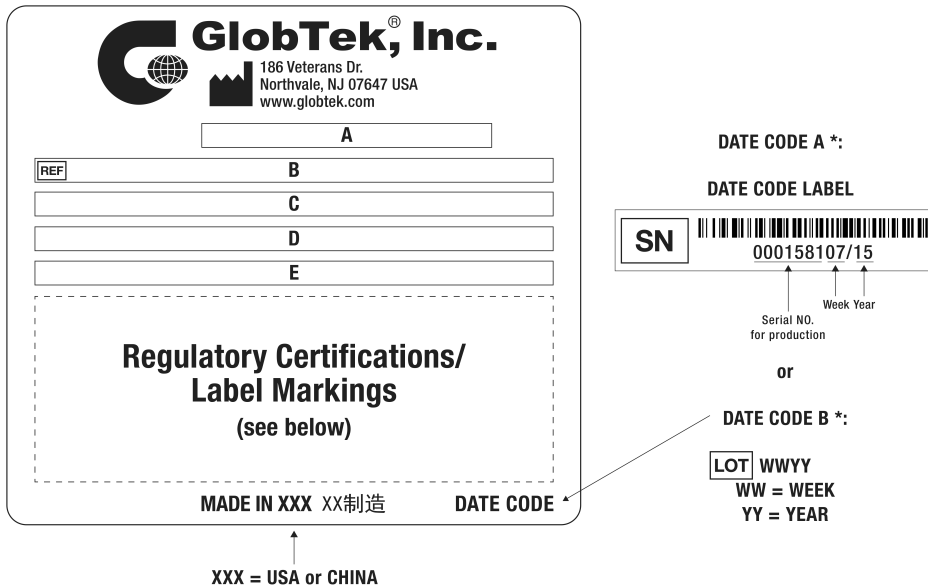

A=ICT / ITE / Medical Power Supply/Class 2/Household Power Supply
 B=P/N: (料号) RR9KE5000CCPCIMR6B
 C=Model (型号) GTM96600-6012-R2
 D=Input (输入)100-240V~, 50-60 Hz, 1.5 A
 E=Output (输出)12.0 V 5.0 A, 60.0W

GlobTek, Inc. www.globtek.com 186 Veterans Drive, Northvale, NJ 07647 Tel. (201) 784-1000 Fax (201) 784-0111	Drawing Title: GTM96600-6012-R2, ICT / ITE / Medical Power Supply/Class 2/Household Power Supply, Efficiency Level: USA DOE Level VI / Eco-design Directive 2009/125/EC, (EU) 2019/1782, Case Color/Style: GlobTek Black, Wall Plug-in+Desktop Combination, Regulated Switchmode AC-DC Power Supply AC Adaptor, Input Rating: 100-240V~, 50-60 Hz, IEC 60320/C8 w/ Wall Blades Option , Output Rating: 60W, 12.0V@5.0A, Output Configuration: 1200 mm, 16/1C + Shield Cond, UL 1185, Female Barrel 5.5*2.1*11mm w/ Spring Clip & Locking Notch or Equal, Ferrite: Core Size: RH 14.2*28.5*10, GlobTek Black, GT Cord # C4670, Pin Out: Center Positive (+V), Blades/Input Cord: R-Series Desktop Insert, Approvals: Korea (41V-54V Only); CB 60335; Fuse 60335; 230V CoC Tier 2; ETL; South Africa; EAC; cETLus 60601-1-11; cETLus 60950-1; UL 1310; CB 62368; Taiwan BSMI; India BIS; UKCA; UL 1310; cETLus 62368-1; CB 61158; NRCAN (5V only); Morocco; Korea (9-15V Only); ETL 60950; S-Mark 60950; RCM; CB 60950; Double Insulation; CB 60601-1; S-Mark IEC/EN 60601-1; CCC; cETLus 60601-1; LPS 60950; PSE; PSE; PSE; CE; China RoHS; Level VI; RoHS; Ukraine; VCCI; WEEE;	
	Model No. GTM96600-6012-R2	
	Part No./Ordering No. RR9KE5000CCPCIMR6B	Rev B1

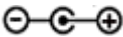
AGENCY ONLINE DOCUMENTS	http://www.globtek.info/certs/GTM96600-TZ/
CE EC-Declaration for Medical	http://globtek.force.com/models/ec_declaration_product?id=01ta0000007dRGr&m=1
CE EC-Declaration for Industrial/Commercial/ITE	http://globtek.force.com/models/ec_declaration_product?id=01ta0000007dRGr&i=2
CE EC-Declaration for Household	http://globtek.force.com/models/ec_declaration_product?id=01ta0000007dRGr&h=2
UKCA-Declaration for Medical	http://globtek.force.com/models/ukca_declaration_product?id=01ta0000007dRGr&m=1
UKCA-Declaration for Industrial/Commercial/ITE	http://globtek.force.com/models/ukca_declaration_product?id=01ta0000007dRGr&i=2
UKCA-Declaration for Household	http://globtek.force.com/models/ukca_declaration_product?id=01ta0000007dRGr&h=2
Morocco SDoC Declaration	https://globtek.secure.force.com/models/Morocco_SDoC_Declaration?id=a0Oa000000MmH0aEAF
RoHS/RoHS3 Declaration	https://www.globtek.com/pdf/rohs_cert/01ta0000007dRGrAAM
REACH Declaration	https://www.globtek.com/pdf/iso_certificates/REACH.pdf
Conflict Minerals Declaration	https://www.globtek.com/pdf/conflict-minerals.pdf
Prop 65 Statement	https://en.globtek.com/prop-65-statement.pdf
IPXY rating is based on 3rd party testing and customers should check suitability and test system level IPXY rating before ordering.	
<h2>Regulatory Certifications/Label Markings</h2>	
Below follows a link to the latest regulatory certifications and marks for this specific product. National standards as well as certification schemes are constantly changing and so is the set of certification marks and symbols applicable to this product. Various standards, marks and symbols, and certificates are subject to change at any time without notice.	
Additional standards or unique country certifications are available upon request. Please contact Globtek to request a quotation.	
LATEST PRODUCT/MODEL CERTIFICATIONS: https://en.globtek.com/datasheet/id/a0Oa000000MmH0a	
AGENCY ONLINE DOCUMENTS:	http://www.globtek.info/certs/GTM96600-TZ/
	(F1) Class II / Double Insulated
	Center Positive (+V)

GlobTek, Inc. www.globtek.com 186 Veterans Drive, Northvale, NJ 07647 Tel. (201) 784-1000 Fax (201) 784-0111	Drawing Title: GTM96600-6012-R2, ICT / ITE / Medical Power Supply/Class 2/Household Power Supply, Efficiency Level: USA DOE Level VI / Eco-design Directive 2009/125/EC, (EU) 2019/1782, Case Color/Style: GlobTek Black, Wall Plug-in+Desktop Combination, Regulated Switchmode AC-DC Power Supply AC Adaptor, Input Rating: 100-240V~, 50-60 Hz, IEC 60320/C8 w/ Wall Blades Option , Output Rating: 60W, 12.0V@5.0A, Output Configuration: 1200 mm, 16/1C + Shield Cond, UL 1185, Female Barrel 5.5*2.1*11mm w/ Spring Clip & Locking Notch or Equal, Ferrite: Core Size: RH 14.2*28.5*10, GlobTek Black, GT Cord # C4670, Pin Out: Center Positive (+V), Blades/Input Cord: R-Series Desktop Insert, Approvals: Korea (41V-54V Only); CB 60335; Fuse 60335; 230V CoC Tier 2; ETL; South Africa; EAC; cETLus 60601-1-11; cETLus 60950-1; UL 1310; CB 62368; Taiwan BSMI; India BIS; UKCA; UL 1310; cETLus 62368-1; CB 61158; NRCAN (5V only); Morocco; Korea (9-15V Only); ETL 60950; S-Mark 60950; RCM; CB 60950; Double Insulation; CB 60601-1; S-Mark IEC/EN 60601-1; CCC; cETLus 60601-1; LPS 60950; PSE; PSE; PSE; CE; China RoHS; Level VI; RoHS; Ukraine; VCCI; WEEE;	
	Model No. GTM96600-6012-R2	
	Part No./Ordering No. RR9KE5000CCPCIMR6B	Rev B1

PACKAGING

Packing Spec P/N:	Desktop/WPI with Desktop Insert T3, User manual
Box Qty:	60
Gift Box Size (mm):	142*62*60
Gift Box Color:	White
Master Carton Size (mm):	442 x 330 x 275
Master Carton Cubic Volume (m³):	0.04
Master GW (Kg):	19.8 kg
BLADES INCLUDED:	R-DI: R-Series Desktop Insert
BLADE/CORD INSTALLED:	R-DI: R-Series Desktop Insert
USER MANUAL*:	809-PSURKITUSERMANUAL on A4 paper
USER MANUAL WEB LINK:	https://www.globtek.com/pdf/809-PSURKITUSERMANUAL.jpg

* This specification sheet is considered the user manual for all applications. It is expected that the buyer of this product will use it to formulate their own user manual for their end product and a user manual specifically for the power adapter is not usually required. If a user manual is not specifically listed above then none will be provided with this unit.

<p>GlobTek, Inc. www.globtek.com 186 Veterans Drive, Northvale, NJ 07647 Tel. (201) 784-1000 Fax (201) 784-0111</p>	<p>Drawing Title: GTM96600-6012-R2, ICT / ITE / Medical Power Supply/Class 2/Household Power Supply, Efficiency Level: USA DOE Level VI / Eco-design Directive 2009/125/EC, (EU) 2019/1782, Case Color/Style: GlobTek Black, Wall Plug-in+Desktop Combination, Regulated Switchmode AC-DC Power Supply AC Adaptor, Input Rating: 100-240V~, 50-60 Hz, IEC 60320/C8 w/ Wall Blades Option , Output Rating: 60W, 12.0V@5.0A, Output Configuration: 1200 mm, 16/1C + Shield Cond, UL 1185, Female Barrel 5.5*2.1*11mm w/ Spring Clip & Locking Notch or Equal, Ferrite: Core Size: RH 14.2*28.5*10, GlobTek Black, GT Cord # C4670, Pin Out: Center Positive (+V), Blades/Input Cord: R-Series Desktop Insert, Approvals: Korea (41V-54V Only); CB 60335; Fuse 60335; 230V CoC Tier 2; ETL; South Africa; EAC; cETLus 60601-1-11; cETLus 60950-1; UL 1310; CB 62368; Taiwan BSMI; India BIS; UKCA; UL 1310; cETLus 62368-1; CB 61158; NRCan (5V only); Morocco; Korea (9-15V Only); ETL 60950; S-Mark 60950; RCM; CB 60950; Double Insulation; CB 60601-1; S-Mark IEC/EN 60601-1; CCC; cETLus 60601-1; LPS 60950; PSE; PSE; PSE; CE; China RoHS; Level VI; RoHS; Ukraine; VCCI; WEEE;</p>	
	<p>Model No. GTM96600-6012-R2</p>	
	<p>Part No./Ordering No. RR9KE5000CCPCIMR6B</p>	<p>Rev B1</p>

PACKAGE CONTENTS INCLUDED	INSTALLED
R-NA-3(R) N	N
R-SAA-3(R) N	N
R-UK-3(R) N	N
R-EU-3(R) N	N
DESKTOP INSERT Y	Y

<p>GlobTek, Inc. www.globtek.com 186 Veterans Drive, Northvale, NJ 07647 Tel. (201) 784-1000 Fax (201) 784-0111</p>	<p>Drawing Title: GTM96600-6012-R2, ICT / ITE / Medical Power Supply/Class 2/Household Power Supply, Efficiency Level: USA DOE Level VI / Eco-design Directive 2009/125/EC, (EU) 2019/1782, Case Color/Style: GlobTek Black, Wall Plug-in+Desktop Combination, Regulated Switchmode AC-DC Power Supply AC Adaptor, Input Rating: 100-240V~, 50-60 Hz, IEC 60320/C8 w/ Wall Blades Option , Output Rating: 60W, 12.0V@5.0A, Output Configuration: 1200 mm, 16/1C + Shield Cond, UL 1185, Female Barrel 5.5*2.1*11mm w/ Spring Clip & Locking Notch or Equal, Ferrite: Core Size: RH 14.2*28.5*10, GlobTek Black, GT Cord # C4670, Pin Out: Center Positive (+V), Blades/Input Cord: R-Series Desktop Insert, Approvals: Korea (41V-54V Only); CB 60335; Fuse 60335; 230V CoC Tier 2; ETL; South Africa; EAC; cETLus 60601-1-11; cETLus 60950-1; UL 1310; CB 62368; Taiwan BSMI; India BIS; UKCA; UL 1310; cETLus 62368-1; CB 61158; NRCAN (5V only); Morocco; Korea (9-15V Only); ETL 60950; S-Mark 60950; RCM; CB 60950; Double Insulation; CB 60601-1; S-Mark IEC/EN 60601-1; CCC; cETLus 60601-1; LPS 60950; PSE; PSE; PSE; CE; China RoHS; Level VI; RoHS; Ukraine; VCCI; WEEE;</p>
	<p>Model No. GTM96600-6012-R2</p>
	<p>Part No./Ordering No. RR9KE5000CCPCIMR6B Rev B1</p>

INSTRUCTIONS TO THE OEM SYSTEMS ENGINEER

It is the responsibility of the OEM systems engineer to provide the end system user instructions and warnings for the use of this product in the end system.

If an input cord is required for this product, AC Mains voltage should be provided to the power supply by a power supply cord approved to the national standards of the country in which it will be used.

This power supply is not designed to be repaired. No serviceable parts inside. A blown internal fuse is an indication of catastrophic failure of circuit component(s). If a Failure Analysis is required for a failed power supply/battery charger, please return the damaged unit to GlobTek for an accurate determination of the root cause of the failure.

EMC Compliance of the complete OEM product, including the GlobTek power supply/battery charger needs to be verified by the OEM systems engineer.

INSTRUCTION SHEET

N/A