

**Circuits
from the Lab®**
Reference Designs

Circuits from the Lab® reference designs are engineered and tested for quick and easy system integration to help solve today's analog, mixed-signal, and RF design challenges. For more information and/or support, visit www.analog.com/CN0537.

Devices Connected/Referenced

ADPD188BI	Integrated Optical Module for Smoke Detection
ADP151	Ultralow Noise, 200 mA, CMOS Linear Regulator
LT8410	Ultralow Power Boost Converter with Output Disconnect

Multistandard Verified Smoke Detector Solution

EVALUATION AND DESIGN SUPPORT

Circuit Evaluation Boards

[CN-0537 Reference Design Board \(EVAL-CN0537-ARDZ\)](#)
[ADICUP3029 Arduino Form Factor Development Board \(EVAL-ADICUP3029\)](#)

Design and Integration Files

[Schematics, Layout Files, Bill of Materials](#)

CIRCUIT FUNCTION AND BENEFITS

Since the 1970s, smoke detectors have become commonplace in commercial and residential buildings. Two basic types of detectors exist today, the ionization type that uses radioactive matter to ionize the air and checks for an electrical imbalance, and the photoelectric type that uses a light source aimed at an angle away from a photodetector and checks for photodetector current caused by the light reflecting from airborne particles to the photodiode. Although a combination solution of both types is recommended, the photoelectric smoke detector is more popular due to its improved reliability in detecting common house fires and faster response times to smoldering fires.

Unfortunately, smoke detector technology and regulations have also remained virtually the same since the 1970s despite the advances in electronics and common household materials through the decades. New revisions in standards, such as *ANSI/UL 217* and *ANSI/UL 268*, published by Underwriters Laboratory (UL), or the *NFPA 72 National Fire Alarm Code*, published by the National Fire Protection Agency (NFPA), aim to address this gap by placing more complex requirements on modern smoke detector designs. Other worldwide standards,

such as EN 14604, EN 54, and ISO 7240 will likely add similar tests to address this and other concerns in the future, making it more important to have more advanced sensing capabilities.

The goal of these updated standards is to increase safety and decrease the number of fire related deaths by reducing the number of false alarms that are generated from everyday activity. For example, in addition to the traditional fire and smoke sensitivity tests, the 8th edition of UL 217 and the 7th edition of UL 268 now requires that smoke detectors do not produce a false alarm during nuisance events, like cooking. Therefore, modern smoke detectors must be able to distinguish between a cooking nuisance event and a fire event. Traditionally, this goal required a complicated solution with multiple sensor technologies and a level of artificial intelligence. However, the use of the ADPD188BI makes this solution significantly more simple to implement.

The circuit shown in Figure 1 is a tested and verified smoke detector reference design with an available algorithm and a data set based on the ADPD188BI optical module. For easy and rapid development, the design is made compatible with the Arduino form factor controller platforms. Software and embedded algorithms combined with the hardware can be used to evaluate smoke and fire tests specified in 8th edition of the UL 217 and the 7th edition of the UL 268 standards. Verified algorithms are available for direct use to help deploy the smoke detection solution faster, and additional data can also be collected and added into the algorithm to adapt it for other standards.

Rev. A

Circuits from the Lab® reference designs from Analog Devices have been designed and built by Analog Devices engineers. Standard engineering practices have been employed in the design and construction of each circuit, and their function and performance have been tested and verified in a lab environment at room temperature. However, you are solely responsible for testing the circuit and determining its suitability and applicability for your use and application. Accordingly, in no event shall Analog Devices be liable for direct, indirect, special, incidental, consequential or punitive damages due to any cause whatsoever connected to the use of any Circuits from the Lab circuits. (Continued on last page)

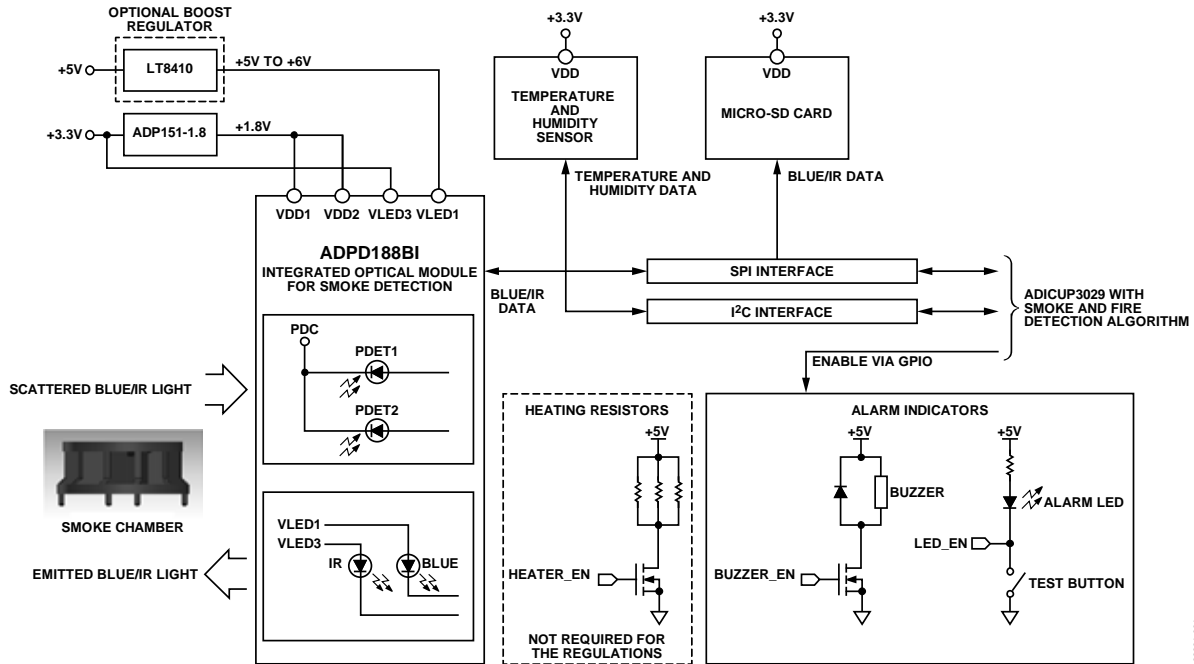

Figure 1. CN-0537 Block Diagram

CIRCUIT DESCRIPTION

Smoke Detection Using the ADPD188BI

The ADPD188BI optical module is a complete photometric system specifically designed for smoke detection applications. Using the ADPD188BI in place of traditional, discrete smoke detector circuits greatly simplifies the design as the optoelectronics (consisting of two LEDs and two photodetectors) and the analog front end (AFE) are already integrated into the package.

To perform smoke detection, the ADPD188BI utilizes a dual-wavelength technique: two integrated LEDs emit light at two different wavelengths and one LED at 470 nm (blue light) and the other LED at 850 nm (infrared light). These LEDs are pulsed in two independent time slots, and the transmitted light is scattered back onto the device by particulate matter in the air.

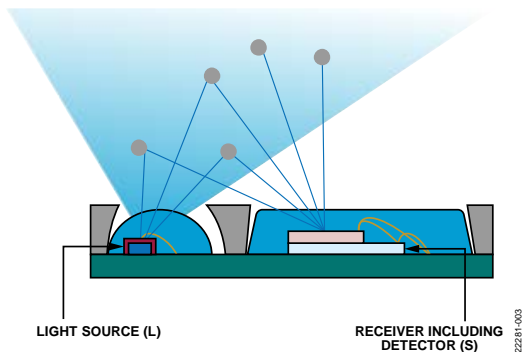

Figure 2. Backscattering of Light from ADPD188BI LEDs

Two integrated photodetectors then receive the scattered light and produce proportional levels of output current, which are converted internally by the AFE into digital code. Assuming the LED optical power is kept constant, an increase in ADPD188BI output values over time indicates an increase or buildup in airborne particles.

UL 217 and UL 268 Smoke and Fire Test Algorithm

The UL 217 and UL 268 standards require detectors to respond to different types of fire and smoke within a specific window of time and obscuration. Table 1 lists the obscuration percentage and response time requirements for each UL 217 and UL 268 test.

Table 1. Fire Conditions and Specifications

Fire Condition	Alarm Time Specification ¹	Alarm Obscuration Specification ¹
Wood Fire	<4 minutes	N/A
Paper Fire	<4 minutes	N/A
Polyurethane Fire	<4 minutes	<5 % per foot
Smoldering Polyurethane Fire	N/A	<12 % per foot
Smoldering Wood	N/A	<10 % per foot
Hamburger Nuisance Test	N/A	Not before <1.5% per foot

¹ N/A means not applicable.

For the CN-0537 reference design, these specifications are met by analyzing the blue and infrared (IR) output data of the ADPD188BI through a smoke detection algorithm.

The EVAL-CN0537-ALGO algorithm was specifically designed for detecting fire conditions using the ADPD188BI sensor and optimized smoke chamber, as defined by the UL 217 and UL 268 standards. The algorithm itself was tuned and verified through a large data set, EVAL-CN0537-DATA, captured from many ADPD188BI devices across all of the test scenarios defined in Table 1. The tests were performed at certified OSHA approved laboratories specializing in fire and life safety. The EVAL-CN0537-DATA data set includes reference measurements to understand sensor performance and alarm conditions for different smoke sources. An example smoke profile is shown in Figure 3, where the IR and blue sensor measures are compared against the reference smoke obscuration data under the Hamburger and Polyurethane test scenario.

Because battery powered devices are a common use case for smoke detectors, the EVAL-CN0537-ALGO was designed and built to minimize the output data required from the ADPD188BI, along with the number of microcontroller computations necessary while still meeting the strict UL 217 and UL 268 standards. For more details on the testing validation, see the test results.

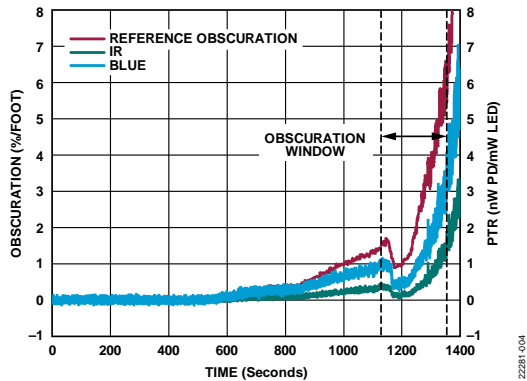

Figure 3. Smoke Profile for Burger Polyurethane Test

Calculating the Power Transfer Ratio

The smoke response of the ADPD188BI is best expressed as a ratio of the received optical power to the transmitted optical power. Referred to as the power transfer ratio (PTR), this parameter is a much more meaningful value than the raw output codes, as it is independent of the actual hardware settings used. Additionally, obscuration level, the standard unit of measurement for smoke detectors, is directly related to the PTR, as shown in Equation 1.

$$PTR = \gamma\beta \tag{1}$$

where:

PTR is the power transfer ratio in nW/mW.

γ is the ADPD188BI scaling factor (0.64 typical for blue light and 0.24 typical for infrared light).

β is the obscuration level in ft⁻¹.

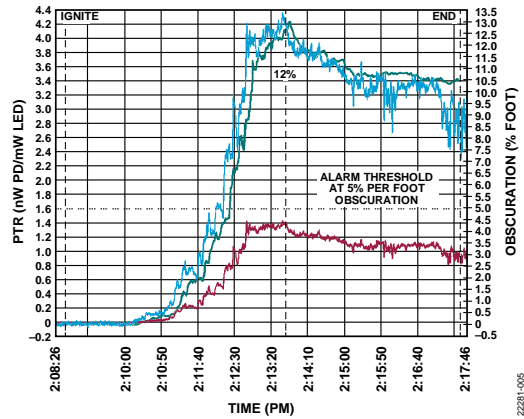

Figure 4. Blue LED PTR, IR LED PTR, and Obscuration Level

For each LED, the PTR can be calculated using Equation 2.

$$PTR = \frac{P_{PD}}{P_{LEDx}} = \frac{I_{PD}}{I_{LEDx_PK}} \times \frac{1}{R_{PD}} \times \frac{1}{\eta_{LED}} \tag{2}$$

where:

PTR is the power transfer ratio of the LED in nW/mW.

I_{PD} is the photodetector current in nA.

I_{LEDx_PK} is the peak LED current in mA.

R_{PD} is the photodetector responsivity in A/W (0.26 typical for blue light and 0.41 typical for infrared light).

η_{LEDx} is the LED efficiency in W/A.

Calculating the I_{LED} and I_{PD}

The ADPD188BI allows for configuring the peak currents of each LED through a combination of course and fine adjustment registers and a current scale factor. The peak LED current can be calculated using Equation 3 to Equation 6.

$$I_{LEDx_PK} = I_{LEDx(COURSE)} + I_{LEDx(FINE)} + I_{LEDx(SCALE)} \tag{3}$$

$$I_{LEDx(COURSE)} = 50.3 + 19.8 \times I_{LEDx_COURSE} \tag{4}$$

$$I_{LEDx(FINE)} = 0.74 + 0.022 \times I_{LEDx_FINE} \tag{5}$$

$$I_{LEDx(SCALE)} = 0.1 + 0.9 \times I_{LEDx_SCALE} \tag{6}$$

where:

I_{LEDx_PK} is the peak LED current in mA.

$I_{LEDx(COURSE)}$ is the LED course current in mA.

$I_{LEDx(FINE)}$ is the LED fine current in mA.

$I_{LEDx(SCALE)}$ is the LED current scaling in mA.

I_{LEDx_COURSE} , I_{LEDx_FINE} , and I_{LEDx_SCALE} are the values for the control registers for each LED. For the integrated blue LED, these can be set in Register Address 0x23 and Register Address 0x25. For the integrated infrared LED, these can be set in Register Address 0x22 and Register Address 0x25. Note that in the ADPD188BI registers, the blue LED is LEDX1 and the infrared LED is LEDX3.

The photodetector current is calculated using the [ADPD188BI](#) digital output, as shown in Equation 7.

$$I_{PD} = Code \times Q \times \frac{1}{PULSE_COUNT} \quad (7)$$

where:

I_{PD} is the photodetector current in nA.

$Code$ is the 32-bit output code in LSB.

Q is the ADC resolution in nA/LSB.

$PULSE_COUNT$ is the number of LED pulses for the time slot.

The ADC resolution of the ADPD188BI is dependent on the setting of the LED pulse width (Register 0x30 for Time Slot A and Register 0x35 for Time Slot B) and the setting of the internal transimpedance amplifier (TIA) gain (Register 0x55). Refer to the ADPD188BI data sheet for the ADC resolution using different TIA gain values.

Calculating the LED Efficiency

The efficiencies of integrated LEDs (η_{LEDx}) can be calculated using Equation 3.

$$\eta_{LED} = \eta_N \times k \times C \quad (8)$$

where:

η_N is the nominal LED efficiency in W/A (0.38 for the blue LED and 0.22 for the infrared LED).

k is the LED derating factor (for the blue LED, this is calculated using Equation 9 and for the infrared LED, $k = 1.0$).

C is a scalar value to compensate for device-to-device differences.

Unlike the infrared LED, the efficiency of the blue LED decreases nonlinearly as the drive current is increased. As such, the derating factor must first be calculated using Equation 9.

$$k = A_0 + A_1 I_{LED} + A_2 (I_{LED})^2 + A_3 (I_{LED})^3 \quad (9)$$

where:

$$A_0 = 9.8976 \times 10^{-1}$$

$$A_1 = -5.1448 \times 10^{-3}$$

$$A_2 = 2.0287 \times 10^{-5}$$

$$A_3 = -2.9645 \times 10^{-8}$$

Reading the ADPD188BI Gain Calibration Values

As shown in Equation 8, the ADPD188BI has a scalar value that compensates for device variation, which is the gain calibration for each LED and is calculated by using Equation 10 to Equation 16.

$$C = \frac{Gain \times I_{LED} + INTER}{NOMINAL_SCALAR} \quad (10)$$

For the blue LED

$$Gain = \frac{21 \times (GAIN_COEFFICIENT - 112)}{256} + 21 \quad (11)$$

$$INTER = 8 \times (INTER_COEFFICIENT - 80) \quad (12)$$

$$NOMINAL_SCALAR = 21 \times I_{LED} + 753 \quad (13)$$

For the infrared LED

$$Gain = \frac{42 \times (GAIN_COEFFICIENT - 112)}{256} + 42 \quad (14)$$

$$INTER = 5 \times (INTER_COEFFICIENT - 80) \quad (15)$$

$$NOMINAL_SCALAR = 42 \times I_{LED} + 156 \quad (16)$$

Note, these calibration equations are valid for devices with Module ID 33. For the calibration equations for devices with Module ID 30 and Module ID 31, refer to the [AN-2033](#).

LED Temperature Compensation

The full loop response of the ADPD188BI is affected by the ambient temperature. For the blue channel, this issue is further complicated because the shape of the temperature response curve can also vary, depending on the amount of LED current used. Figure 5 illustrates the temperature effect on the relative output response across the ADPD188BI operating temperature range, using the common I_{LED} settings of 100 mA and 175 mA for the blue LED. For the infrared channel, the temperature response curve is independent of the LED current.

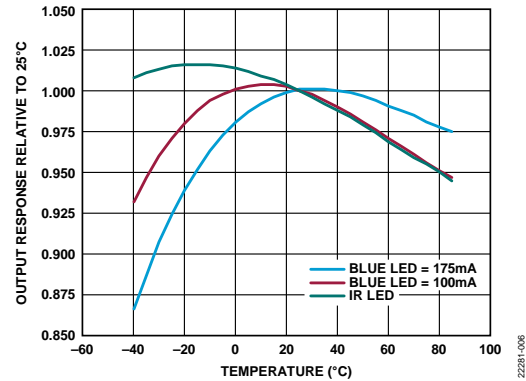

Figure 5. Temperature Effect on the ADPD188BI Output Response Relative to 25°C

To determine the value of the relative response, the ability to measure the ambient temperature in real time is required. On the [CN-0537](#), a temperature and humidity sensor monitors the conditions inside the chamber, next to the ADPD188BI. Compensation for the temperature effect can then be done by dividing the ADPD188BI output by the relative response for the current ambient temperature, taken from the appropriate curve in Figure 5.

$$Code_{25^\circ C} = \frac{Code_T}{RelativeResponse_T} \quad (17)$$

where:

$RelativeResponse_T$ is the relative response at the current ambient temperature.

$Code_T$ is the output code at the current ambient temperature.

$Code_{25^\circ C}$ is the output code at temperature 25°C.

When selecting a sensor, the component size is the primary consideration because space is at a premium inside a chamber. In this reference design, the default sensor has temperature and humidity accuracy ratings of $\pm 0.2^{\circ}\text{C}$ and $\pm 2\%$ relative humidity, respectively.

Using a Smoke Chamber with the ADPD188BI

Most smoke detector solutions available in the market use smoke chambers to help reject ambient light, reduce internal light pollution, and minimize the risk of insects or spiders interfering with the readings. For the ADPD188BI, using a smoke chamber causes a constant background signal to appear in the readings due to light scattering from the chamber surface. It is critical that the level of the background signal be kept similar or below the alarm threshold to avoid significant errors in the readings.

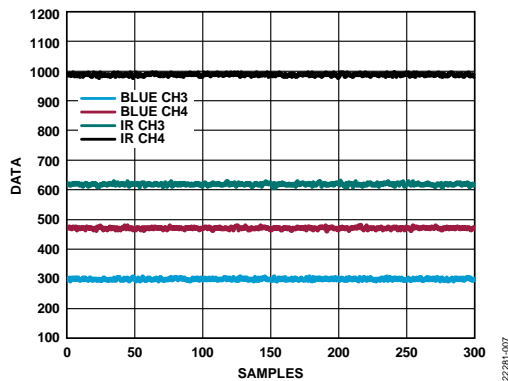

Figure 6. Background Signal Appearing on ADPD188BI Readings

The response of the ADPD188BI to the chamber can also be expressed in a power transfer ratio (PTR), adding to the smoke response and must be considered when interpreting the PTR data of the device.

$$PTR_{TOTAL} = PTR_{CHAMBER} + PTR_{SMOKE} \tag{17}$$

where:

PTR_{TOTAL} is the total power transfer ratio in nW/mW.

$PTR_{CHAMBER}$ is the ratio of the received optical power from the inside of the chamber surface to the transmitted optical power, in nW/mW.

PTR_{SMOKE} is the ratio of the received optical power due to smoke particles scattering the transmitted optical power, in nW/mW.

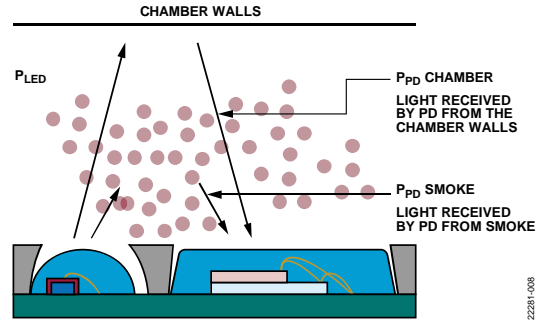

Figure 7. Backscattering of Light by the Chamber Walls and Smoke

The ADPD188BI uses the Analog Devices, Inc., proprietary smoke chamber that is specifically designed to meet device and industry requirements. The internal geometry of this smoke chamber allows for the highest signal-to-noise ratio (SNR) readings and, therefore, optimal PTR values for the ADPD188BI.

The mechanical design was qualified using stress tests specified by industry standards, such as JESD22-A101, JESD22-A103, JESD22-A104, UL 217, UL 268, EN 54, and AEC-Q100. The chamber is also significantly smaller than most existing solutions due to the size of the ADPD188BI relative to discrete smoke detectors. The design only measures 36 mm across the ends of its two large flanges and leaves an internal area of 109.36 mm² underneath it.

Conventional smoke chamber designs are incompatible with the ADPD188BI because the integrated optoelectronics of the ADPD188BI use a backscattering system as opposed to the forward scattering system used by traditional smoke detectors.

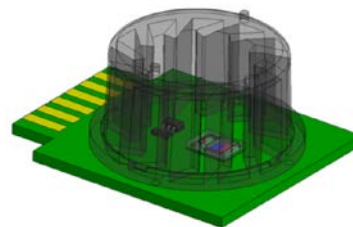

Figure 8. ADPD188BI with Smoke Chamber

Anticondensation Heating

For some regions of the world, condensation can be a nuisance that must be dealt with to maintain the effectiveness of the smoke detection unit. To address this condensation, CN-0537 provides optional heater resistors and a humidity sensor to enable custom algorithm development. If dew and condensation may form on the inside surface of the chamber, it can cause light scattering that appears as smoke to the system. This light scattering is particularly problematic in the more humid, tropical regions of the world where condensation formation is a common occurrence.

To mitigate the effect of condensation, heating resistors are placed around the optical module, which are meant to dissipate enough heat to clear out dew formation as the need arises. When selecting resistors for this purpose, a compromise is needed between the desired temperature rise and the current drawn from the power supply.

Note that this heating block significantly increases the total system power required by the design. Using lower resistance values generates more heat but draws more supply current. For battery-powered systems, lower resistance values also results in a shorter battery life and must be an additional design consideration.

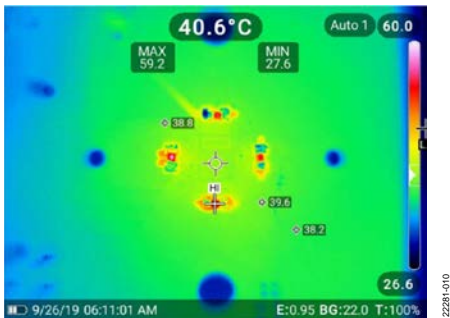

Figure 9. Infrared Image of the CN-0537 Heating Resistors

The CN-0537 reference design uses a parallel combination of three 25 Ω resistors, resulting in a temperature increase of 10°C to 20°C. A transistor switch allows the microcontroller board to activate the heating circuit block through a pulse width modulated (PWM) output or a general-purpose input/output (GPIO) pin.

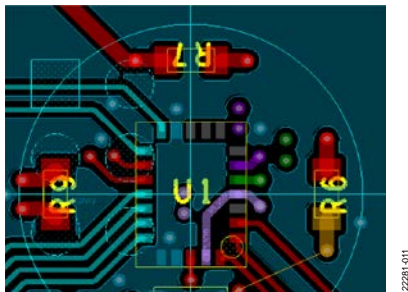

Figure 10. Placement of Heating Resistors

System Power Management

Power to the CN-0537 is sourced from the controller board through the Arduino form-factor connectors and the most active devices in the circuit are directly powered by the 3.3 V and 5 V supplies. The ADPD188BI, however, requires supply voltage levels of 1.8 V, 3.3 V, and ≥5 V for proper operation.

To produce the 1.8 V required to power the ADPD188BI, the 3.3 V regulated power is fed into an ADP151. This CMOS linear regulator has an input voltage range of 2.2 V to 5.5 V and a maximum output current of 200 mA. The output voltage of the ADP151 is fixed to 1.8 V during production of the device and only requires input and output capacitors for operation, greatly simplifying the circuit design.

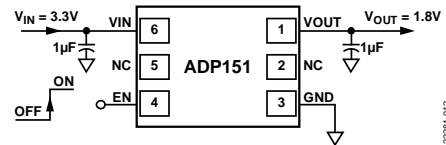

Figure 11. ADP151 Basic Connections

Similarly, to produce the voltage required to power the integrated blue LED of the ADPD188BI, the 5 V supply is fed into an LT8410 ultra-low power boost converter, implemented as shown in Figure 12.

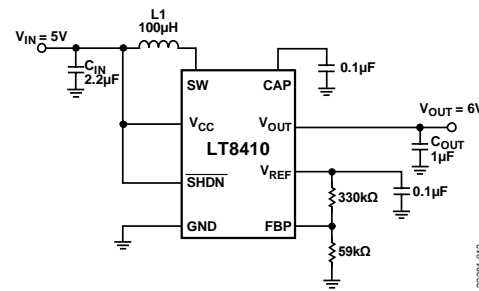

Figure 12. LT8410 Basic Connections

The regulated output of the LT8410 is directly related to the voltage level on its positive feedback pin (FBP). To produce a desired level of V_{OUT}, the necessary level of V_{FBP} is calculated using Equation 18.

$$V_{FBP} = V_{OUT} \div 31.85 \tag{18}$$

where:

V_{FBP} is the voltage across the FBP pin and GND in V.

V_{OUT} is the desired output voltage in V.

For an output voltage of 6 V, Equation 18 results in a V_{FBP} of approximately 0.1884 V. To achieve this voltage level, a simple voltage divider is used with the integrated 1.235 V reference voltage of the LT8410, as shown in Figure 12. When selecting resistors for the voltage divider, ensure that the series resistance is greater than 200 kΩ to avoid loading down the V_{REF} pin.

As recommended by the LT8410 data sheet, the capacitors used for the input and output pins have values of 2.2 µF and 1 µF, respectively and 0.1 µF capacitors are used for the CAP and VREF pins.

When selecting an inductor, the [LT8410](#) data sheet recommends an inductor with at least 45 μH and a saturation current rating higher than the peak inductor current. Use Equation 19 to calculate the maximum peak inductor current.

$$I_{PK} = I_{LIMIT} + \frac{V_{IN} \times 150 \times 10^{-6}}{L} \quad (19)$$

where:

I_{PK} is the peak inductor current in mA.

I_{LIMIT} is the switch current limit in mA.

V_{IN} is the input voltage in V.

L is the inductance in H.

A 100 μH inductor was used in this design and substituting this value in the equation results in a peak inductor current of 37.5 mA for an input voltage of 5 V and a maximum switch current limit of 30 mA.

Use Equation 20 to Equation 23 to determine the maximum output current of the LT8410 circuit.

$$I_{RIPPLE} = \frac{(V_{OUT} + 1 - V_{IN}) \times 200 \times 10^{-6}}{L} \quad (20)$$

$$I_{IN(AVG)} = I_{PK} - \frac{I_{RIPPLE}}{2} \quad (21)$$

$$I_{OUT(NOM)} = \frac{I_{IN(AVG)} \times V_{IN} \times 0.7}{V_{OUT}} \quad (22)$$

$$I_{OUT} = I_{OUT(NOM)} \times 0.8 \quad (23)$$

where:

I_{RIPPLE} is the inductor ripple current in mA.

$I_{IN(AVG)}$ is the average LT8410 input current in mA.

$I_{OUT(NOM)}$ is the nominal output current in mA.

I_{OUT} is the maximum output current in mA.

Substituting the inductance of 100 μH and a peak inductor current of 37.5 mA into these equations results in a maximum output current of 14.23 mA for an input voltage of 5 V and a typical switch current limit of 25 mA. Simulating this LT8410 circuit in LTspice® across a range of load currents results in the efficiency plot shown in Figure 13.

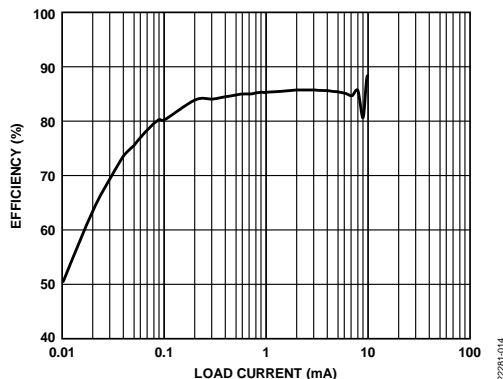

Figure 13. LT8410 Efficiency vs. Load Current Plot

Use Equation 24 to calculate the amount of supply current for each LED required by the [ADPD188BI](#) from the [ADP151](#) and LT8410 circuits.

$$I_{LED_AVE_x} = \frac{SLOTx_LED_WIDTH \times I_{LED1_PK} \times DR \times PULSE_COUNT}{PULSE_COUNT} \quad (24)$$

where:

$I_{LED_AVE_x}$ is the average LED supply current in mA for Time Slot A or Time Slot B.

$SLOTx_LED_WIDTH$ is the blue LED pulse width in seconds for Time Slot A or Time Slot B.

I_{LEDx_PK} is the peak current in mA (calculated using Equation 3 to Equation 6).

DR is the output data rate in Hz.

$PULSE_COUNT$ is the number of LED pulses in Time Slot A or Time Slot B.

COMMON VARIATIONS

If humidity sensing is not needed for the smoke detection algorithm, the [ADT7302](#) digital temperature sensors can be used in place of the ADPD188BI. The ADT7302 has a small footprint that can be placed under the chamber, an accuracy of 2°C with a resolution of 0.03125°C, but comes at a fraction of the cost of the default sensor (ADPD188BI).

CIRCUIT EVALUATION AND TEST

The following section outlines the general setup for evaluating the [CN-0537](#). For complete setup and other detailed instructions see the [EVAL-CN0537-ARDZ Hardware User Guide](#).

Equipment Needed

The following equipment is needed:

[EVAL-CN0537-ARDZ](#)

[EVAL-ADICUP3029](#)

Micro SD card

Micro USB to USB Type A cable

PC or laptop with a USB port

Serial terminal application

[CN0537.hex](#) file

Setup and Test

For system evaluation, the CN-0537 includes demonstration application software that allows the user to communicate to the on-board ADPD188BI using the EVAL-ADICUP3029 development platform. Take the following steps to use this software:

1. Download the latest version of the CN-0537 demonstration application software (*.hex) file from the [EVAL-CN0537-ARDZ Hardware User Guide](#).

2. Connect the [EVAL-ADICUP3029](#) to a computer. The board should appear as an external DAPLINK drive to the computer.
3. Upload the [CN-0537](#) demonstration application software to the EVAL-ADICUP3029 by dragging and dropping the hex file into the DAPLINK drive.
4. Run the serial terminal program on the computer.
 - a. Set the serial port to the one assigned to the EVAL-ADICUP3029.
5. Insert a micro-SD card into Port P5 on the EVAL-CN0537-ARDZ.
6. Connect the EVAL-CN0537-ARDZ to the EVAL-ADICUP3029 through the Arduino form-factor connectors.
7. Press the push button, S1, on the EVAL-ADICUP3029 (labeled as **3029_RESET**). The serial terminal displays a welcome banner and awaits user input.
8. Type, **s**, the command to start the data stream.
 - a. The software begins capturing the blue and infrared responses and displays them on the serial terminal in PTR values.
9. Type, **i**, the command, to stop the data stream.

To obtain a copy of the files printed to the serial terminal, remove the micro SD card from the EVAL-CN0537-ARDZ and read its contents using the computer. The contents of the data stream are saved as a .csv file.

For complete setup and other detailed instructions, see the EVAL-CN0537-ARDZ Hardware User Guide.

LEARN MORE

[LTspice[®] SPICE Simulation Software](#)

[LTpowerCAD[®] Design Tool](#)

[AN-1567 Application Note, Smoke Testing with the ADPD188BI Optical Smoke and Aerosol Detection Module, Analog Devices.](#)

[AN-2033 Application Note, Calibrating the ADPD188BI Optical Smoke and Aerosol Detection Module, Analog Devices](#)

UL Standard for Safety for Smoke Alarms, 8th edition, ANSI/UL 217, Underwriters Laboratory, Oct. 2015.

UL Standard for Smoke Detectors for Fire Alarm Systems, 7th edition, ANSI/UL 268, Underwriters Laboratory, Jan. 2016.

National Fire Alarm and Signaling Code, 2019 edition, NFPA 72, National Fire Protection Agency, 2019.

T. Clearly, “A Study on the Performance of Current Smoke Alarms to the New Dire and Nuisance Tests Prescribed in ANSI/UL 217-2015.” Nat. Inst. Sci. and Technol., U.S. Dept. of Commerce, MD, USA, NIST.TN.1947, 2016.

A. Lee and T. Clearly. (Sep. 2017). Smoke Alarms – Where Are We Now and the Outlook for the Future. Presented at the 2017 Suppression, Detection, and Signaling Res. and Appl. Conf. (SUPDET 2017), College Park, MD, USA. [Online].

Data Sheets and Evaluation Boards

[CN-0537 Reference Design Board \(EVAL-CN0537-ARDZ\)](#)

[ADICUP3029 Development Platform \(EVAL-ADICUP3029\)](#)

[ADPD188BI Data Sheet](#)

[ADPD188BI Evaluation Board \(EVAL-ADPD188BIZ-S2\)](#)

[ADP151 Data Sheet](#)

[ADP151 Evaluation Board \(EVAL-ADP151\)](#)

[LT8410/LT8410-1 Data Sheet](#)

[LT8410 Demo Board \(DC1387A-A\)](#)

REVISION HISTORY

6/2021—Rev 0 to Rev. A

Changes to Circuit Note Title and Circuit Function and Benefits Section 1

Changes to Figure 1..... 2

Changed UL-217 Smoke and Fire Test Algorithm Section to UL 217 and UL 268 Smoke and Fire Test Algorithm Section..... 2

Changes to UL 217 and UL 268 Smoke and Fire Test Algorithm Section and Table 1 2

Changes to Calculating the LED Efficiency Section, Equation 11 through Equation 16, and Reading the ADPD188BI Gain Calibration Values Section 4

Changes to Anticondensation Heating Section 5

Changes to System Power Management Section 6

Changes to Learn More Section 8

7/2020—Revision 0: Initial Version

(Continued from first page) Circuits from the Lab reference designs are intended only for use with Analog Devices products and are the intellectual property of Analog Devices or its licensors. While you may use the Circuits from the Lab reference designs in the design of your product, no other license is granted by implication or otherwise under any patents or other intellectual property by application or use of the Circuits from the Lab reference designs. Information furnished by Analog Devices is believed to be accurate and reliable. However, Circuits from the Lab reference designs are supplied "as is" and without warranties of any kind, express, implied, or statutory including, but not limited to, any implied warranty of merchantability, noninfringement or fitness for a particular purpose and no responsibility is assumed by Analog Devices for their use, nor for any infringements of patents or other rights of third parties that may result from their use. Analog Devices reserves the right to change any Circuits from the Lab reference designs at any time without notice but is under no obligation to do so.



Mouser Electronics

Authorized Distributor

Click to View Pricing, Inventory, Delivery & Lifecycle Information:

[Analog Devices Inc.:](#)

[EVAL-CN0537-ARDZ](#)