



# Board (Narrow Footprint) to Cable

.050"

9 thru 100 Contacts

Rugged Board Mount

**MK, ML**

Rugged Cable

**MM, MN**

MK-253-031-335-220S  
(METAL)

ML-251-031-335-220S  
(PLASTIC)

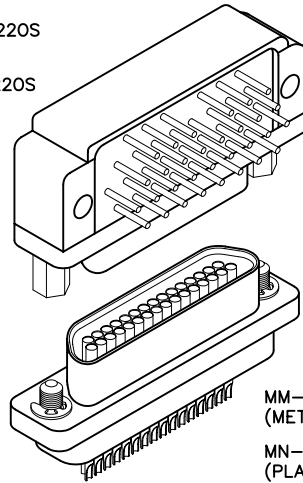

MM-223-031-213-4100  
(METAL)

MN-221-031-213-4100  
(PLASTIC)

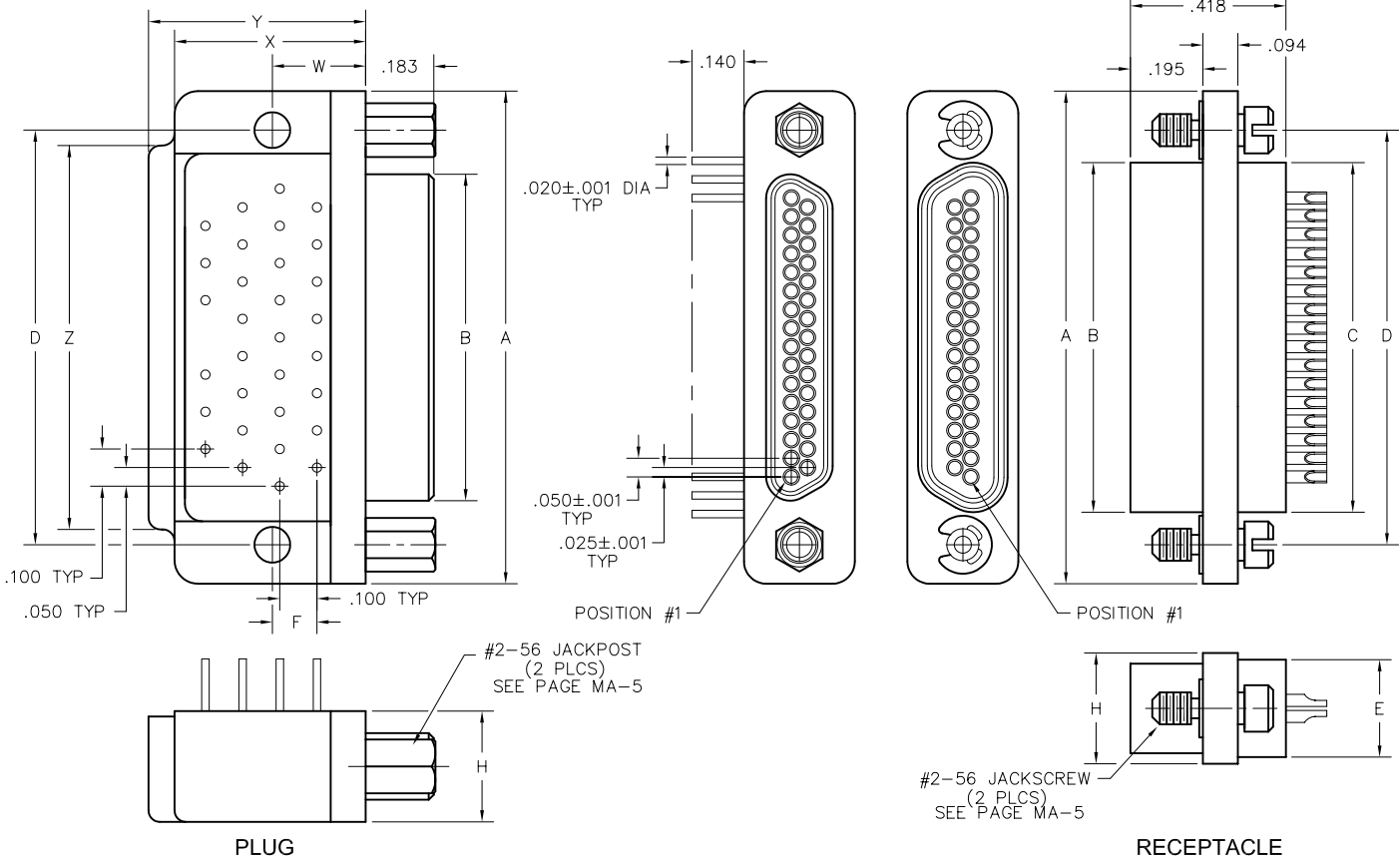

SIZE	CONTACT ROWS	DIMENSIONS											HARDWARE	MOUNTING HOLE		
		A	B		C	D	E		F	H	W	X MAX			Y MAX	Z
			PLUG MAX	RCPT MAX			POTTING WELL MAX									
9	2	.775	.334	.400	.390	.565	.270	.120	.298	.250	.420	.420	.775	#2-56 UNC THD (.092 DIA THRU)	.096 DIA OR #2-56 UNC THREADED INSERT	
15		.925	.484	.550	.540	.715							.925			
21		1.075	.634	.700	.690	.865							1.075			
25		1.175	.734	.800	.790	.965							1.175			
31		1.325	.884	.950	.940	1.115							1.325			
37	1.475	1.034	1.100	1.090	1.265	1.475	.450	.520	1.180							
51	3	1.425	.984	1.050	1.040	1.215	.310	.150	.341	.300	.430	.650	1.220	#4-40 UNC THD (.147 DIA THRU)	.125 DIA OR #2-56 UNC THREADED INSERT	
69*		1.725	1.284	1.350	1.340	1.515						.755	1.450			
100	4	2.160	1.384	1.508	1.432	1.800	.360	.200	.384	.400	.590	1.000	1.810			

\* = 69 POSITION CONNECTORS ARE AVAILABLE IN METAL ONLY.

**PLUG:** MK-253-031-335-220S

**RECEPTACLE:** MM-223-031-213-4100

**PLUG:** ML-251-031-335-220S

**RECEPTACLE:** MN-221-031-213-4100

XX-XXX-XXX-XXX-XXXX-XXX

**PLUG**

**RECEPTACLE**

SERIES	
MK .050" Rugged Metal PC Board Mount Connector ML .050" Rugged Plastic PC Board Mount Connector (MK & ML mate with MK, ML, MM, MN receptacles)	MM .050" Rugged Metal I/O Connector MN .050" Rugged Plastic I/O Connector (MM & MN mate with MK, ML, MM, MN plugs)
BODY	
2 2-Row (Sizes 9 thru 37) 3 3-Row (Size 51 & 69***) 4 4-Row (Size 100)	2 2-Row (Sizes 9 thru 37) 3 3-Row (Size 51 & 69***) 4 4-Row (Size 100)
<b>BODY STYLE:</b> 5 Plug, right angle, narrow footprint, w/ mtg holes	<b>BODY STYLE:</b> 2 Receptacle, straight, with ears
<b>BODY MATERIAL:</b> 1 Polyphenylene Sulfide (ML only) 2 Polyphenylene Sulfide with electroless nickel shell 3 Polyphenylene Sulfide with electrodeposited cadmium shell <input checked="" type="checkbox"/> 4 Polyphenylene Sulfide with hard anodized black shell 5 Polyphenylene Sulfide with stainless steel shell	<b>BODY MATERIAL:</b> 1 Polyphenylene Sulfide (MN only) 2 Polyphenylene Sulfide with electroless nickel shell 3 Polyphenylene Sulfide with electrodeposited cadmium shell <input checked="" type="checkbox"/> 4 Polyphenylene Sulfide with hard anodized black shell 5 Polyphenylene Sulfide with stainless steel shell
SIZE	
XXX 009, 015, 021, 025, 031, 037, 051, 069***, 100	XXX 009, 015, 021, 025, 031, 037, 051, 069***, 100
CONTACTS	
<b>TYPE CONTACTS/TERMINATIONS:</b> 32 Pin, right angle, PCB leads, .109" 33 Pin, right angle, PCB leads, .140" 34 Pin, right angle, PCB leads, .172"	<b>TYPE CONTACTS/TERMINATIONS:</b> 21 Socket, straight, solder cup 24 Socket, straight, .500" pigtails (.018 dia) 25 Socket, straight, 1.000" pigtails (.018 dia) 26 Socket, straight, crimped wire
<b>PLATING OPTIONS:</b> 3 50 μ" Au contacts; 10 μ" Au terminations 5 50 μ" Au contacts; Sn/Pb alloy terminations <input checked="" type="checkbox"/> 7 50 μ" Au contacts; SAC305 terminations	<b>PLATING OPTIONS:</b> 1 50 μ" Au contacts (crimp wire) 3 50 μ" Au contacts; 10 μ" Au terminations (solder cup, pigtail) 5 50 μ" Au contacts; Sn/Pb alloy terminations (pigtail) <input checked="" type="checkbox"/> 7 50 μ" Au contacts; SAC305 terminations (pigtail)
HARDWARE	
<b>STYLE OF HARDWARE:</b> 00 None 22 Two fixed jacknut assemblies (62*) 41 Two turning jackscrews, allen head, retaining ring**** (81*) 99 Keying hardware, see options below (Body material 2, 3 and 4 only)	<b>STYLE OF HARDWARE:</b> 00 None 22 Two fixed jacknut assemblies (62*) 41 Two turning jackscrews, allen head, retaining ring (81*) 42 Two long turning jackscrews, allen head, retaining ring (82*) 43 Two turning jackscrews, slot head, retaining ring (83*) 44 Two long turning jackscrews, slot head, retaining ring (84*) 45 Two turning jackscrews, allen head, captivated** (85*) 99 Keying hardware, see options below (Body material 2, 3 and 4 only)
<b>POLARIZATION / WIRING:</b> 0R Reversed body polarization 0S Standard body polarization	<b>POLARIZATION / WIRING</b> 00 None XX For wiring codes, see page MA-3 & MA-4
OPTIONS	
KPXX Two fixed jacknuts. See page MA-6 for keying options (KN*) 94P Mil-Spec footprint (size 100 only), standard body polarization 0B7 Threaded inserts, standard body polarization 0BJ Mil-Spec footprint (size 100 only) with threaded inserts, standard body polarization	KSXX Two turning jackscrews and interfacial sealing gasket. See page MA-6 for keying options (KJ*) 900 Interfacial sealing gasket

\* = Use numbers or letters in parenthesis when ordering size 100.

\*\*\* = 69 position connectors are available in metal only.

\*\* = Captive hardware is factory installed and non-removable.

\*\*\*\* = Connector body has no mounting holes.

= Option not RoHS compliant



# Recommended PC Board Layout

Right Angle, Narrow Footprint  
Standard Polarization



CONNECTOR MATING FACE

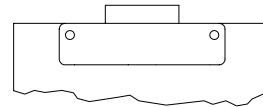

PC BOARD LAYOUT COMPONENT SIDE

PLUG  
PC BOARD LAYOUT  
COMPONENT SIDE

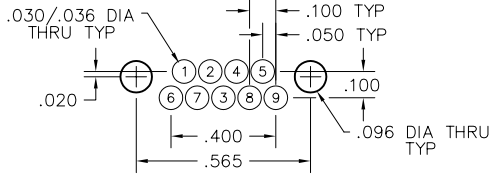

CONNECTOR MATING FACE\*  
(RECEPTACLE)

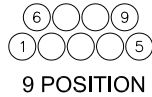

RECEPTACLE  
PC BOARD LAYOUT  
COMPONENT SIDE

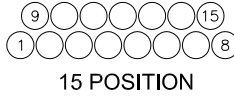
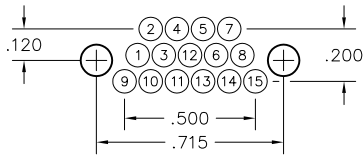
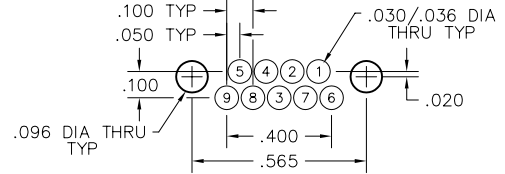

15 POSITION

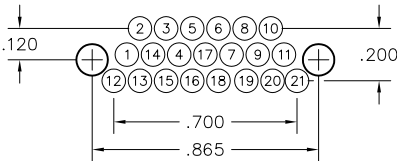
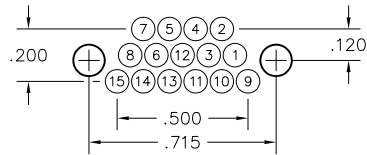

21 POSITION

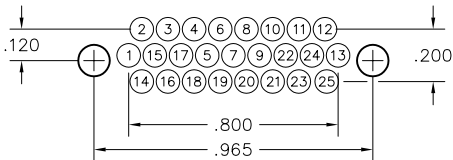
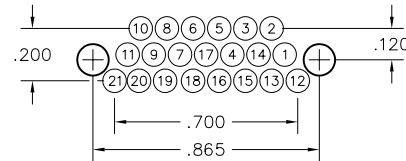

25 POSITION

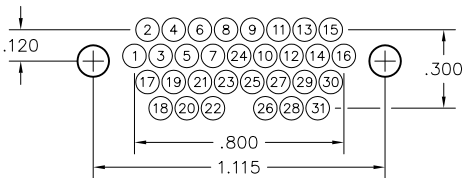
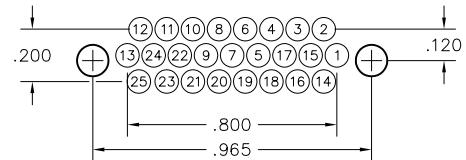

31 POSITION

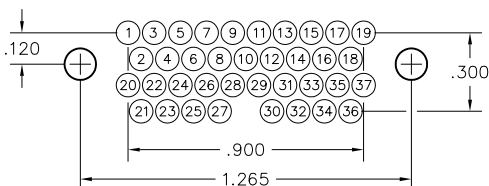
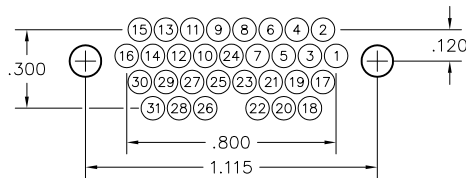

37 POSITION

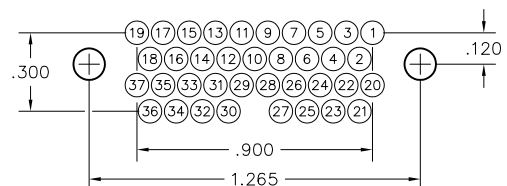

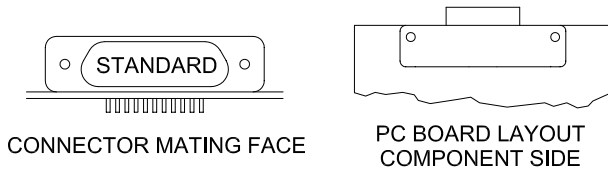

## Recommended PC Board Layout

Right Angle, Narrow Footprint  
Standard Polarization

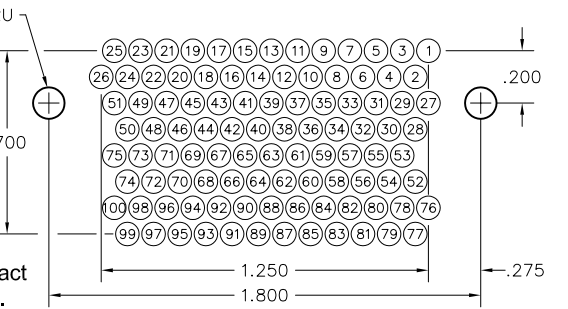
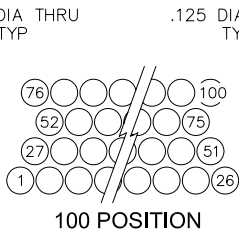
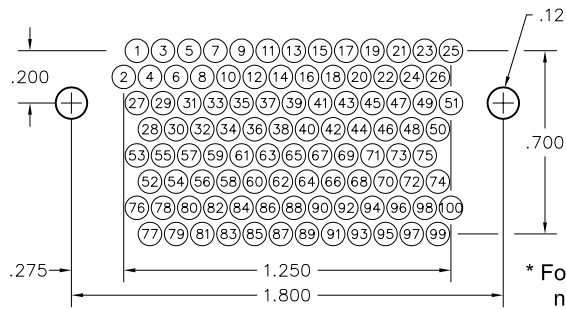
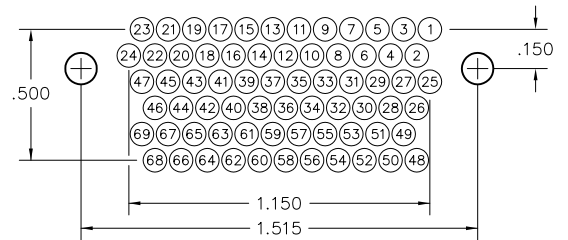
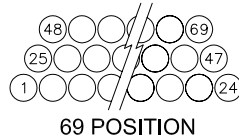
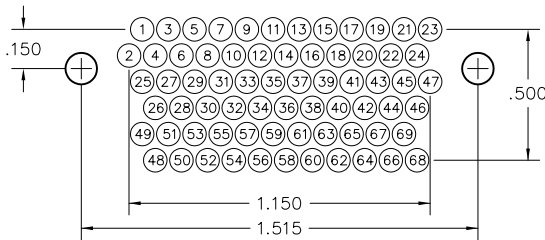
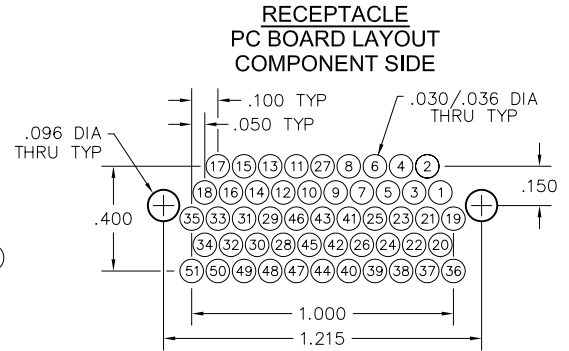
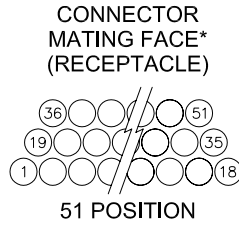
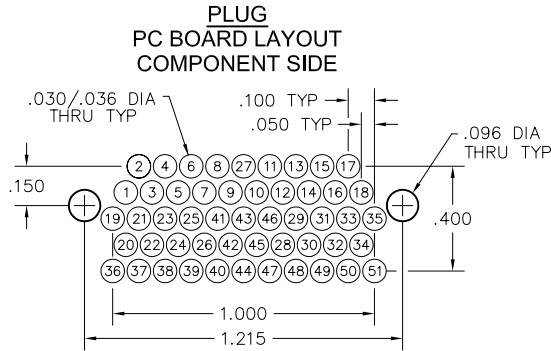

\* For pin (plug) connectors, the contact numbers are reversed left to right.

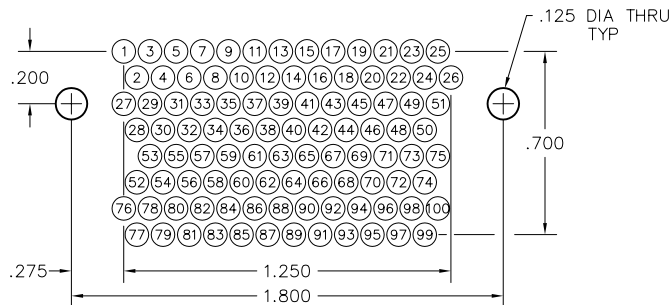

**Mil-Spec Footprint**  
For Mil-Spec footprint, use "Option" -94P



# Recommended PC Board Layout

Right Angle, Narrow Footprint  
Reverse Polarization

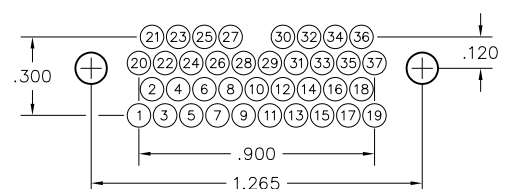
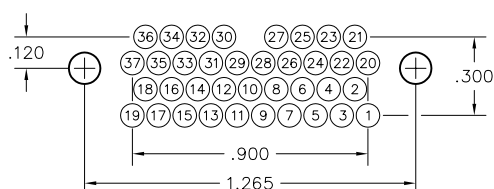
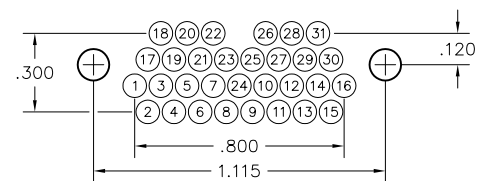
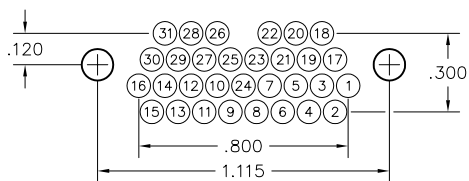
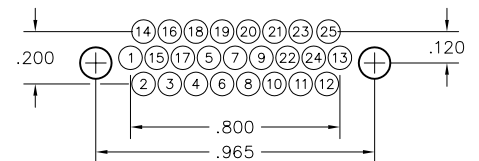
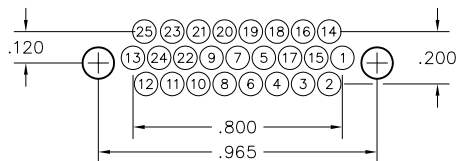
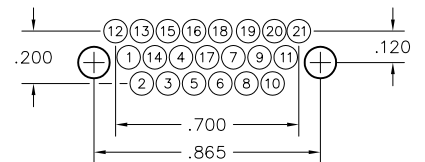
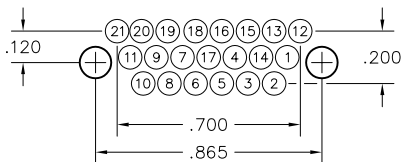
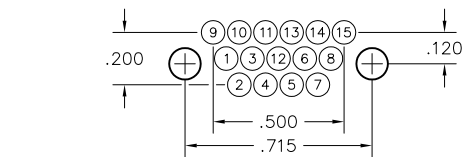
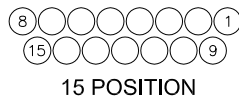
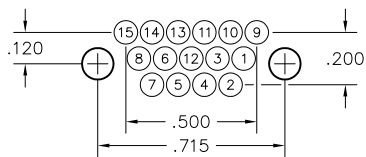
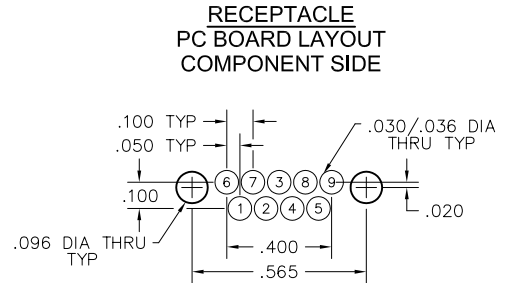
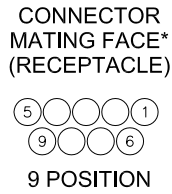
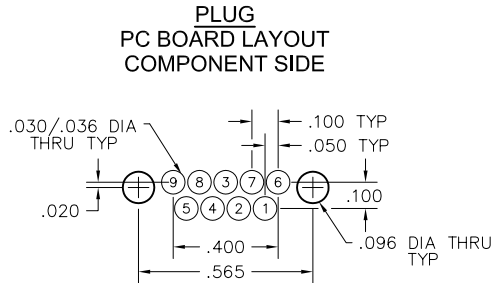
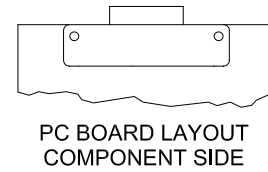
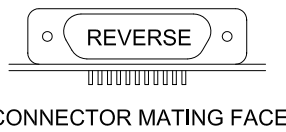

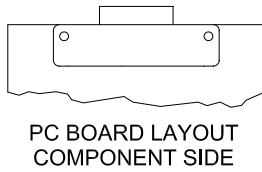
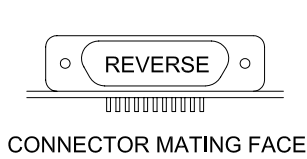

**AirBorn**  
**Recommended PC Board Layout**  
 Right Angle, Narrow Footprint  
 Reverse Polarization

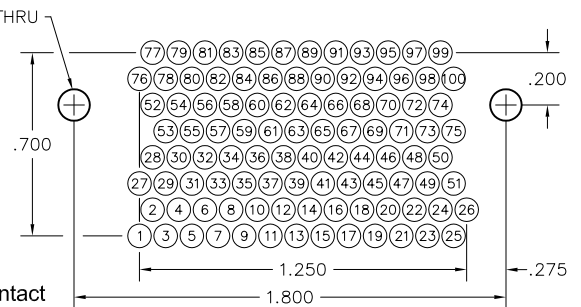
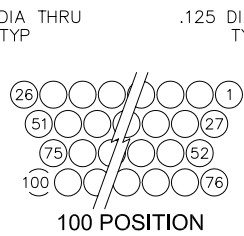
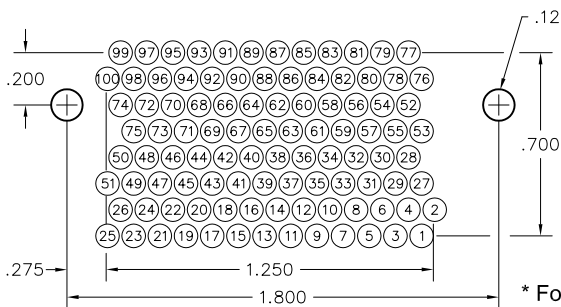
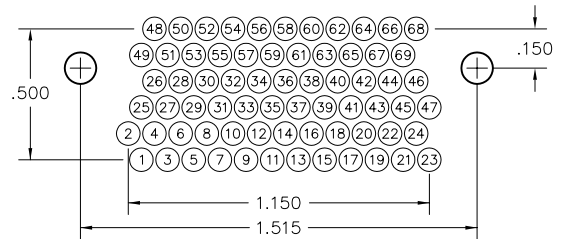
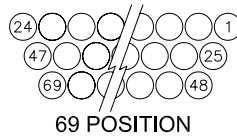
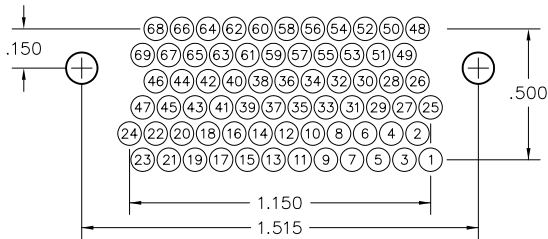
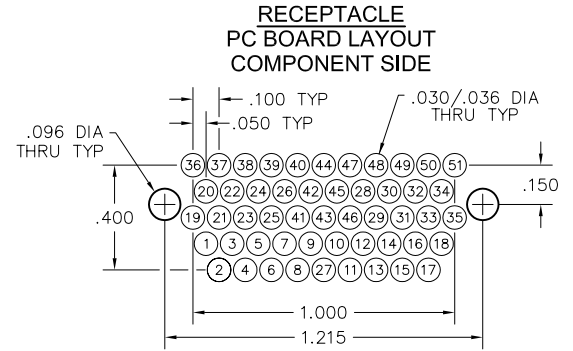
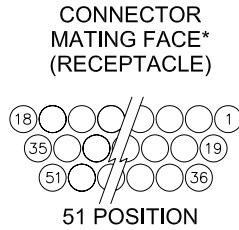
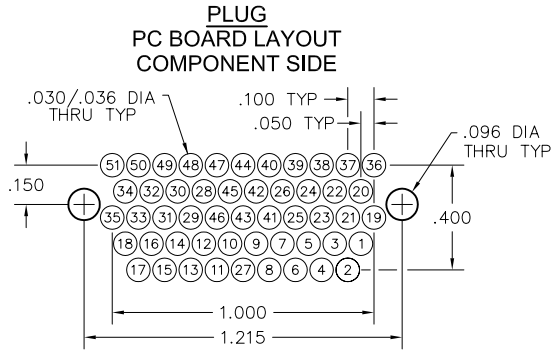

\* For pin (plug) connectors, the contact numbers are reversed left to right.



# POLARIZED KEYING HARDWARE

11		21		31		41		51		61	
12		22		32		42		52		62	
13		23		33		43		53		63	
14		24		34		44		54		64	
15		25		35		45		55		65	
16		26		36		46		56		66	

Select the appropriate two digit number above and include as the last two digits of the hardware code in the part number. (Keying hardware is factory installed and non-removable).

Example:

MM-213-025-161-99WA-KS11

MK-263-025-435-990S-KP11

KEYING JACKPOST – KP  
(100 POSITION = KN)

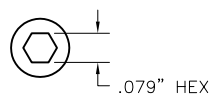
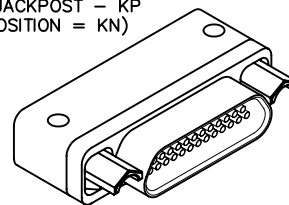

HEX DETAIL - JACKSCREWS

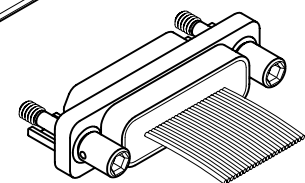

KEYING JACKSCREW – KS  
(100 POSITION = KJ)





## M83513 / 13 (continued)

M83513 / 13-F02NT	MK-262-037-445-000S-0B7	M83513 / 13-F03CN	MK-263-037-455-000S-900	M83513 / 13-F03NT	MK-262-037-455-000S-0B7
M83513 / 13-F02NW	MK-262-037-445-220S-0B7	M83513 / 13-F03CP	MK-263-037-455-220S-900	M83513 / 13-F03NW	MK-262-037-455-220S-0B7
M83513 / 13-F02PN	MK-265-037-445-000S-900	M83513 / 13-F03CT	MK-263-037-455-000S-0B7	M83513 / 13-F03PN	MK-265-037-455-000S-900
M83513 / 13-F02PP	MK-265-037-445-220S-900	M83513 / 13-F03CW	MK-263-037-455-220S-0B7	M83513 / 13-F03PP	MK-265-037-455-220S-900
M83513 / 13-F02PT	MK-265-037-445-000S-0B7	M83513 / 13-F03NN	MK-262-037-455-000S-900	M83513 / 13-F03PT	MK-265-037-455-000S-0B7
M83513 / 13-F02PW	MK-265-037-445-220S-0B7	M83513 / 13-F03NP	MK-262-037-455-220S-900	M83513 / 13-F03PW	MK-265-037-455-220S-0B7

## M83513 / 14

M83513 / 14-G01CN	MK-363-051-435-000S-900	M83513 / 14-G02CN	MK-363-051-445-000S-900	M83513 / 14-G03CN	MK-363-051-455-000S-900
M83513 / 14-G01CP	MK-363-051-435-220S-900	M83513 / 14-G02CP	MK-363-051-445-220S-900	M83513 / 14-G03CP	MK-363-051-455-220S-900
M83513 / 14-G01CT	MK-363-051-435-000S-0B7	M83513 / 14-G02CT	MK-363-051-445-000S-0B7	M83513 / 14-G03CT	MK-363-051-455-000S-0B7
M83513 / 14-G01CW	MK-363-051-435-220S-0B7	M83513 / 14-G02CW	MK-363-051-445-220S-0B7	M83513 / 14-G03CW	MK-363-051-455-220S-0B7
M83513 / 14-G01NN	MK-362-051-435-000S-900	M83513 / 14-G02NN	MK-362-051-445-000S-900	M83513 / 14-G03NN	MK-362-051-455-000S-900
M83513 / 14-G01NP	MK-362-051-435-220S-900	M83513 / 14-G02NP	MK-362-051-445-220S-900	M83513 / 14-G03NP	MK-362-051-455-220S-900
M83513 / 14-G01NT	MK-362-051-435-000S-0B7	M83513 / 14-G02NT	MK-362-051-445-000S-0B7	M83513 / 14-G03NT	MK-362-051-455-000S-0B7
M83513 / 14-G01NW	MK-362-051-435-220S-0B7	M83513 / 14-G02NW	MK-362-051-445-220S-0B7	M83513 / 14-G03NW	MK-362-051-455-220S-0B7
M83513 / 14-G01PN	MK-365-051-435-000S-900	M83513 / 14-G02PN	MK-365-051-445-000S-900	M83513 / 14-G03PN	MK-365-051-455-000S-900
M83513 / 14-G01PP	MK-365-051-435-220S-900	M83513 / 14-G02PP	MK-365-051-445-220S-900	M83513 / 14-G03PP	MK-365-051-455-220S-900
M83513 / 14-G01PT	MK-365-051-435-000S-0B7	M83513 / 14-G02PT	MK-365-051-445-000S-0B7	M83513 / 14-G03PT	MK-365-051-455-000S-0B7
M83513 / 14-G01PW	MK-365-051-435-220S-0B7	M83513 / 14-G02PW	MK-365-051-445-220S-0B7	M83513 / 14-G03PW	MK-365-051-455-220S-0B7

## M83513 / 15

M83513 / 15-H01CN	MK-463-100-435-000S-900	M83513 / 15-H02CN	MK-463-100-445-000S-900	M83513 / 15-H03CN	MK-463-100-455-000S-900
M83513 / 15-H01CP	MK-463-100-435-620S-900	M83513 / 15-H02CP	MK-463-100-445-620S-900	M83513 / 15-H03CP	MK-463-100-455-620S-900
M83513 / 15-H01CT	MK-463-100-435-000S-0B7	M83513 / 15-H02CT	MK-463-100-445-000S-0B7	M83513 / 15-H03CT	MK-463-100-455-000S-0B7
M83513 / 15-H01CW	MK-463-100-435-620S-0B7	M83513 / 15-H02CW	MK-463-100-445-620S-0B7	M83513 / 15-H03CW	MK-463-100-455-620S-0B7
M83513 / 15-H01NN	MK-462-100-435-000S-900	M83513 / 15-H02NN	MK-462-100-445-000S-900	M83513 / 15-H03NN	MK-462-100-455-000S-900
M83513 / 15-H01NP	MK-462-100-435-620S-900	M83513 / 15-H02NP	MK-462-100-445-620S-900	M83513 / 15-H03NP	MK-462-100-455-620S-900
M83513 / 15-H01NT	MK-462-100-435-000S-0B7	M83513 / 15-H02NT	MK-462-100-445-000S-0B7	M83513 / 15-H03NT	MK-462-100-455-000S-0B7
M83513 / 15-H01NW	MK-462-100-435-620S-0B7	M83513 / 15-H02NW	MK-462-100-445-620S-0B7	M83513 / 15-H03NW	MK-462-100-455-620S-0B7
M83513 / 15-H01PN	MK-465-100-435-000S-900	M83513 / 15-H02PN	MK-465-100-445-000S-900	M83513 / 15-H03PN	MK-465-100-455-000S-900
M83513 / 15-H01PP	MK-465-100-435-620S-900	M83513 / 15-H02PP	MK-465-100-445-620S-900	M83513 / 15-H03PP	MK-465-100-455-620S-900
M83513 / 15-H01PT	MK-465-100-435-000S-0B7	M83513 / 15-H02PT	MK-465-100-445-000S-0B7	M83513 / 15-H03PT	MK-465-100-455-000S-0B7
M83513 / 15-H01PW	MK-465-100-435-620S-0B7	M83513 / 15-H02PW	MK-465-100-445-620S-0B7	M83513 / 15-H03PW	MK-465-100-455-620S-0B7

## M83513 / 16

M83513 / 16-A01CN	MK-273-009-325-000R	M83513 / 16-A02NW	MK-272-009-335-220R-0B7	M83513 / 16-B01CN	MK-273-015-325-000R
M83513 / 16-A01CP	MK-273-009-325-220R	M83513 / 16-A02PN	MK-275-009-335-000R	M83513 / 16-B01CP	MK-273-015-325-220R
M83513 / 16-A01CT	MK-273-009-325-000R-0B7	M83513 / 16-A02PP	MK-275-009-335-220R	M83513 / 16-B01CT	MK-273-015-325-000R-0B7
M83513 / 16-A01CW	MK-273-009-325-220R-0B7	M83513 / 16-A02PT	MK-275-009-335-000R-0B7	M83513 / 16-B01CW	MK-273-015-325-220R-0B7
M83513 / 16-A01NN	MK-272-009-325-000R	M83513 / 16-A02PW	MK-275-009-335-220R-0B7	M83513 / 16-B01NN	MK-272-015-325-000R
M83513 / 16-A01NP	MK-272-009-325-220R	M83513 / 16-A03CN	MK-273-009-345-000R	M83513 / 16-B01NP	MK-272-015-325-220R
M83513 / 16-A01NT	MK-272-009-325-000R-0B7	M83513 / 16-A03CP	MK-273-009-345-220R	M83513 / 16-B01NT	MK-272-015-325-000R-0B7
M83513 / 16-A01NW	MK-272-009-325-220R-0B7	M83513 / 16-A03CT	MK-273-009-345-000R-0B7	M83513 / 16-B01NW	MK-272-015-325-220R-0B7
M83513 / 16-A01PN	MK-275-009-325-000R	M83513 / 16-A03CW	MK-273-009-345-220R-0B7	M83513 / 16-B01PN	MK-275-015-325-000R
M83513 / 16-A01PP	MK-275-009-325-220R	M83513 / 16-A03NN	MK-272-009-345-000R	M83513 / 16-B01PP	MK-275-015-325-220R
M83513 / 16-A01PT	MK-275-009-325-000R-0B7	M83513 / 16-A03NP	MK-272-009-345-220R	M83513 / 16-B01PT	MK-275-015-325-000R-0B7
M83513 / 16-A01PW	MK-275-009-325-220R-0B7	M83513 / 16-A03NT	MK-272-009-345-000R-0B7	M83513 / 16-B01PW	MK-275-015-325-220R-0B7
M83513 / 16-A02CN	MK-273-009-335-000R	M83513 / 16-A03NW	MK-272-009-345-220R-0B7	M83513 / 16-B02CN	MK-273-015-335-000R
M83513 / 16-A02CP	MK-273-009-335-220R	M83513 / 16-A03PN	MK-275-009-345-000R	M83513 / 16-B02CP	MK-273-015-335-220R
M83513 / 16-A02CT	MK-273-009-335-000R-0B7	M83513 / 16-A03PP	MK-275-009-345-220R	M83513 / 16-B02CT	MK-273-015-335-000R-0B7
M83513 / 16-A02CW	MK-273-009-335-220R-0B7	M83513 / 16-A03PT	MK-275-009-345-000R-0B7	M83513 / 16-B02CW	MK-273-015-335-220R-0B7
M83513 / 16-A02NN	MK-272-009-335-000R	M83513 / 16-A03PW	MK-275-009-345-220R-0B7	M83513 / 16-B02NN	MK-272-015-335-000R
M83513 / 16-A02NP	MK-272-009-335-220R			M83513 / 16-B02NP	MK-272-015-335-220R
M83513 / 16-A02NT	MK-272-009-335-000R-0B7			M83513 / 16-B02NT	MK-272-015-335-000R-0B7

# Mouser Electronics

Authorized Distributor

Click to View Pricing, Inventory, Delivery & Lifecycle Information:

## AirBorn:

[MK-353-051-335-220S](#) [MK-252-015-325-220S](#) [MK-453-100-345-000R](#) [MK-452-100-335-000R](#) [MK-453-100-345-000S](#) [MK-452-100-345-810R](#) [MK-352-051-335-410R](#) [MK-353-051-335-410R](#) [MK-453-100-325-810S](#) [MK-453-100-335-000S](#) [MK-453-100-335-810R](#) [MK-352-051-325-410R](#) [MK-453-100-325-000R](#) [MK-452-100-335-620R](#) [MK-453-100-345-620S](#) [MK-353-051-335-000R](#) [MK-352-051-345-410S](#) [MK-353-051-345-000R](#) [MK-353-051-325-000R](#) [MK-352-051-345-220R](#) [MK-252-037-345-410S](#) [MK-253-037-345-000R](#) [MK-252-037-325-410R](#) [MK-253-025-325-410R](#) [MK-252-031-345-410S](#) [MK-253-037-325-410R](#) [MK-253-037-325-410S](#) [MK-252-037-335-410R](#) [MK-253-025-335-000R](#) [MK-252-037-335-000R](#) [MK-252-037-345-000R](#) [MK-252-037-345-220R](#) [MK-252-031-335-220R](#) [MK-252-009-335-220R](#) [MK-253-037-345-410S](#) [MK-253-025-335-220R](#) [MK-253-025-325-000R](#) [MK-252-025-345-410R](#) [MK-253-025-345-410R](#) [MK-252-009-325-220R](#) [MK-252-015-345-410S](#) [MK-252-021-335-220R](#) [MK-252-021-335-410R](#) [MK-252-009-325-000R](#) [MK-253-021-345-220R](#) [MK-252-025-345-000R](#) [MK-253-009-325-410S](#) [MK-252-015-345-220R](#) [MK-252-021-335-410S](#) [MK-252-009-325-410S](#) [MK-253-037-335-000R](#) [MK-253-037-335-410S](#) [MK-252-031-335-000R](#) [MK-252-037-335-220R](#) [MK-253-037-335-220R](#) [MK-252-037-345-410R](#) [MK-252-015-335-220R](#) [MK-253-021-325-410S](#) [MK-253-021-335-410R](#) [MK-253-025-345-220R](#) [MK-253-031-345-410R](#) [MK-253-015-345-410R](#) [MK-252-021-345-220R](#) [MK-253-021-345-410S](#) [MK-253-009-335-410R](#) [MK-253-009-345-000R](#) [MK-253-015-325-410S](#) [MK-252-009-335-000R](#) [MK-252-009-345-220R](#) [MK-252-015-345-000R](#) [MK-252-009-345-410S](#) [MK-252-021-345-410R](#) [MK-252-025-335-410R](#) [MK-252-009-345-410R](#) [MK-253-037-325-000S](#) [MK-253-031-335-000S](#) [MK-252-021-325-000S](#) [MK-252-025-325-000S](#) [MK-253-009-325-000S](#) [MK-252-025-335-220S](#) [MK-253-037-345-000S](#) [MK-353-051-335-000S](#) [MK-252-031-335-000S](#) [MK-352-051-335-000S](#) [MK-252-037-345-220S](#) [MK-252-009-325-000S](#) [MK-253-015-335-000S](#) [MK-253-031-345-000S](#) [MK-353-051-345-220S](#) [MK-253-025-335-000S](#) [MK-253-031-325-220S](#) [MK-252-009-345-000S](#) [MK-253-021-335-220S](#) [MK-253-021-345-000S](#) [MK-253-009-335-220S](#) [MK-253-009-345-220S](#) [MK-253-015-335-220S](#) [MK-252-015-345-220S](#) [MK-453-100-325-000S](#) [MK-453-100-345-810S](#)