

FEATURES

- Up to 96% efficiency
- 0.8 V to V_{OUT} input voltage range
- Low 0.9 V input start-up voltage
- 1.8 V to 3.3 V output voltage range
- 23 μ A quiescent current
- Fixed PWM and light load PFM mode options
- Synchronous rectification
- True shutdown output Isolation
- Internal soft start, compensation, and current limit
- 2 mm \times 2 mm, 6-lead LFCSP
- Compact solution size

APPLICATIONS

- 1-cell and 2-cell alkaline and NiMH/NiCd powered devices
- Portable audio players, instruments, and medical devices
- Solar cell applications
- Miniature hard disk power supplies
- Power LED status indicators

GENERAL DESCRIPTION

The ADP1607 is a high efficiency, synchronous, fixed frequency, step-up dc-to-dc switching converter with an adjustable output voltage between 1.8 V and 3.3 V for use in portable applications.

The 2 MHz operating frequency enables the use of small footprint, low profile external components. Additionally, the synchronous rectification, internal compensation, internal fixed current limit, and current mode architecture allow for excellent transient response and a minimal external part count.

Other key features include fixed PWM and light load PFM mode options, true output isolation, thermal shutdown (TSD), and logic controlled enable. Available in a lead-free, thin, 6-lead LFCSP package, the ADP1607 is ideal for providing efficient power conversion in portable devices.

TYPICAL APPLICATION CIRCUIT

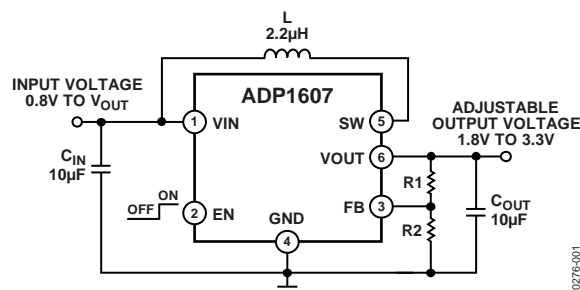

Figure 1.

TABLE OF CONTENTS

Features	1	Overview	10
Applications.....	1	Enable/Shutdown	10
General Description	1	Modes of Operation	10
Typical Application Circuit	1	Internal Control Features	11
Revision History	2	Applications Information	12
Specifications.....	3	Setting the Output Voltage.....	12
Absolute Maximum Ratings.....	4	Inductor Selection	12
Thermal Operating Ranges	4	Choosing the Input Capacitor	13
Thermal Resistance	4	Choosing the Output Capacitor	13
ESD Caution.....	4	Layout Guidelines.....	14
Pin Configuration and Function Descriptions.....	5	Outline Dimensions	15
Typical Performance Characteristics	6	Ordering Guide	15
Theory of Operation	10		

REVISION HISTORY

12/13—Rev. B to Rev. C

Changes to Figure 21

7/13—Rev. A to Rev. B

Changes to Captions for Figure 22 and Figure 23.....

Changed Synchronous Rectification Section.....

12/12—Rev. 0 to Rev. A

Changes to Features Section.....

Changed T_j to T_A in Specifications Section.....

Changed Figure 6, Figure 7, and Figure 8 Captions.....

Changes to Table 5

Changes to Choosing the Output Capacitor Section.....

10/12—Revision 0: Initial Version

SPECIFICATIONS

$V_{IN} = V_{EN} = 1.2\text{ V}$, $V_{OUT} = 3.3\text{ V}$ at $T_A = -40^\circ\text{C}$ to $+85^\circ\text{C}$ for minimum/maximum specifications, and $T_A = 25^\circ\text{C}$ for typical specifications, unless otherwise noted.¹

Table 1.

Parameter	Symbol	Test Conditions/Comments	Min	Typ	Max	Unit
SUPPLY						
Minimum Start-Up Voltage ²	V_{IN}	$R_{MIN} = 22\ \Omega$	0.9			V
Operating Input Voltage Range ³			0.8		V_{OUT}	V
Shutdown Current	I_{QSD}	$V_{EN} = \text{GND}$, $V_{OUT} = \text{GND}$, $T_A = -40^\circ\text{C}$ to $+45^\circ\text{C}$ ⁴		0.06	0.67	μA
Quiescent Current		Nonswitching, measured on V_{OUT} , auto operating mode part only				
		$T_A = -40^\circ\text{C}$ to $+45^\circ\text{C}$		23	29	μA
		$T_A = -40^\circ\text{C}$ to $+85^\circ\text{C}$		23	40	μA
		Measured on V_{IN}				
		$T_A = -40^\circ\text{C}$ to $+45^\circ\text{C}$		6	11	μA
		$T_A = -40^\circ\text{C}$ to $+85^\circ\text{C}$		6	14.6	μA
Soft Start Time				1.3		ms
SWITCH						
Current Limit	I_{CL}		0.8	1	1.3	A
NMOS On Resistance	$R_{DS(ON)_N}$	$I_{SW} = 500\text{ mA}$		116	165	$\text{m}\Omega$
PMOS On Resistance	$R_{DS(ON)_P}$	$I_{SW} = 500\text{ mA}$		155	225	$\text{m}\Omega$
SW Leakage Current		$V_{SW} = 1.2\text{ V}$, $V_{OUT} = 0\text{ V}$, $T_A = -40^\circ\text{C}$ to $+45^\circ\text{C}$ ⁴		0.18	2	μA
OSCILLATOR						
Switching Frequency	f_{SW}		1.8	2	2.2	MHz
Maximum Duty Cycle	D_{MAX}		85	90		%
OUTPUT						
V_{OUT} Range	V_{OUT}		1.8		3.3	V
FB Pin Voltage	V_{FB}	PWM mode	1.2338	1.259	1.2842	V
FB Pin Current	I_{FB}	$V_{FB} = 1.26\text{ V}$		0.1	0.25	μA
EN/MODE LOGIC						
Input Voltage Threshold Low	V_{IL}				0.25	V
Input Voltage Threshold High	V_{IH}		0.8			V
EN/MODE Leakage Current		$V_{EN} = \text{GND}$ or V_{IN} , $V_{OUT} = 0\text{ V}$		0.001	0.25	μA
THERMAL SHUTDOWN ⁵						
Thermal Shutdown Threshold				150		$^\circ\text{C}$
Thermal Shutdown Hysteresis				15		$^\circ\text{C}$

¹ All limits at temperature extremes are guaranteed via correlation using standard statistical quality control (SQC). Specifications are subject to change without notice.

² Guaranteed by design, but not production tested. V_{IN} can never exceed V_{OUT} once the ADP1607 is enabled.

³ Minimum value is characterized by design. Maximum value is characterized on the bench.

⁴ This parameter is the semiconductor leakage current. The semiconductor leakage current doubles with every 10°C increase in temperature. The maximum limit follows the same trend over temperature.

⁵ Thermal shutdown protection is only active in PWM mode.

ABSOLUTE MAXIMUM RATINGS

Table 2.

Parameter	Rating
VIN, VOUT to GND	−0.3 V to +3.6 V
FB to GND	−0.3 V to +1.4 V
EN, SW to GND (when VIN ≥ VOUT)	−0.3 V to VIN + 0.3 V
EN, SW to GND (when VIN < VOUT)	−0.3 V to VOUT + 0.3 V
EPAD to GND	−0.3 V to +0.3 V
Operating Ambient Temperature Range	−40°C to +85°C
Operating Junction Temperature Range	−40°C to +90°C
Storage Temperature Range	−65°C to +150°C
Soldering Conditions	JEDEC J-STD-020

Stresses above those listed under Absolute Maximum Ratings may cause permanent damage to the device. This is a stress rating only; functional operation of the device at these or any other conditions above those indicated in the operational section of this specification is not implied. Exposure to absolute maximum rating conditions for extended periods may affect device reliability.

Absolute maximum ratings apply individually only, not in combination.

THERMAL OPERATING RANGES

The ADP1607 can be damaged when the junction temperature limits are exceeded. The maximum operating junction temperature ($T_{J(MAX)}$) takes precedence over the maximum operating ambient temperature ($T_{A(MAX)}$). Monitoring ambient temperature does not guarantee that the junction temperature (T_J) is within the specified temperature limits.

In applications with high power dissipation and poor PCB thermal resistance, the maximum ambient temperature may need to be derated. In applications with moderate power dissipation and low PCB thermal resistance, the maximum ambient temperature can exceed the maximum limit as long as the junction temperature is within specification limits.

The junction temperature T_J of the device is dependent on the ambient temperature (T_A), the power dissipation of the device (P_D), and the junction-to-ambient thermal resistance of the package (θ_{JA}). Maximum junction temperature (T_J) is calculated from the ambient temperature (T_A) and power dissipation (P_D) using the following formula:

$$T_J = T_A + (P_D \times \theta_{JA})$$

THERMAL RESISTANCE

Junction-to-ambient thermal resistance (θ_{JA}) of the package is specified for the worst-case conditions, that is, a device soldered in a circuit board for surface-mount packages. The junction-to-ambient thermal resistance is highly dependent on the application and board layout. In applications where high maximum power dissipation exists, attention to thermal board design is required. The value of θ_{JA} may vary, depending on PCB material, layout, and environmental conditions.

θ_{JA} and θ_{JC} (junction to case) are determined according to JESD51-9 on a 4-layer PCB with natural convection cooling and the exposed pad soldered to the board with thermal vias.

Table 3.

Package Type	θ_{JA}	θ_{JC}	Unit
6-Lead LFCSP	66.06	4.3	°C/W

ESD CAUTION



ESD (electrostatic discharge) sensitive device. Charged devices and circuit boards can discharge without detection. Although this product features patented or proprietary protection circuitry, damage may occur on devices subjected to high energy ESD. Therefore, proper ESD precautions should be taken to avoid performance degradation or loss of functionality.

PIN CONFIGURATION AND FUNCTION DESCRIPTIONS

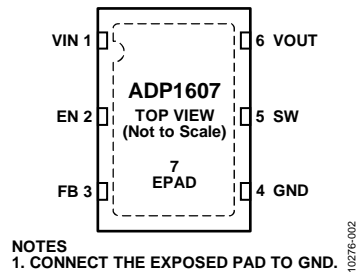

Figure 2. Pin Configuration

Table 4. Pin Function Descriptions

Pin No.	Mnemonic	Description
1	VIN	Analog and Power Supply Pin.
2	EN	Shutdown Control Pin. Drive EN high to turn on the synchronous boost, drive EN low to turn it off.
3	FB	Output Voltage Feedback Pin.
4	GND	Analog and Power Ground Pin.
5	SW	Drain Connection for NMOS and PMOS Power Switches.
6	VOUT	Output Voltage and Source Connection of PMOS Power Switch.
7	EPAD	Exposed Pad. Connect to GND.

TYPICAL PERFORMANCE CHARACTERISTICS

$V_{IN} = 1.2\text{ V}$, $V_{OUT} = 3.3\text{ V}$, $L = 2.2\ \mu\text{H}$ ($D_{CR_{MAX}} = 66\ \text{m}\Omega$, VLF302512MT-2R2M), $C_{IN} = 10\ \mu\text{F}$, $C_{OUT} = 10\ \mu\text{F}$ (10 V, 20%, LMK107BJ106MALT), $V_{EN} = V_{IN}$, and $T_A = 25^\circ\text{C}$, unless otherwise noted.

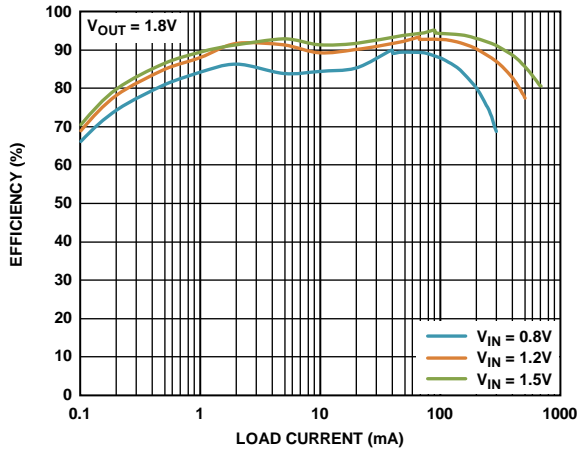

Figure 3. Auto Mode Efficiency vs. Load Current, $V_{OUT} = 1.8\text{ V}$

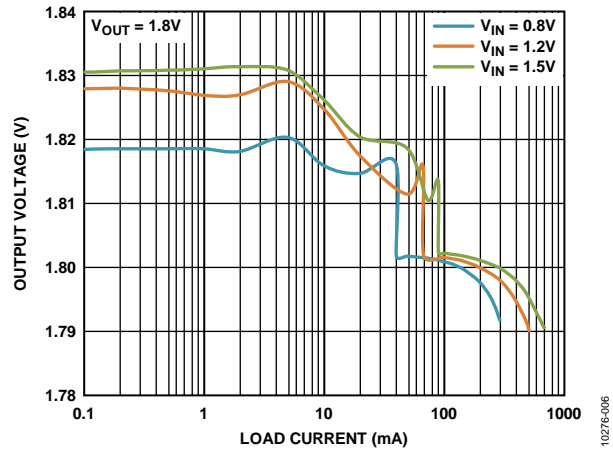

Figure 6. Auto Mode Output Voltage Load Regulation, $V_{OUT} = 1.8\text{ V}$

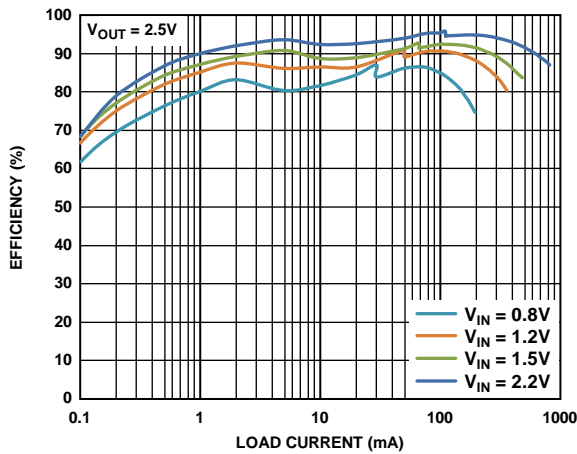

Figure 4. Auto Mode Efficiency vs. Load Current, $V_{OUT} = 2.5\text{ V}$

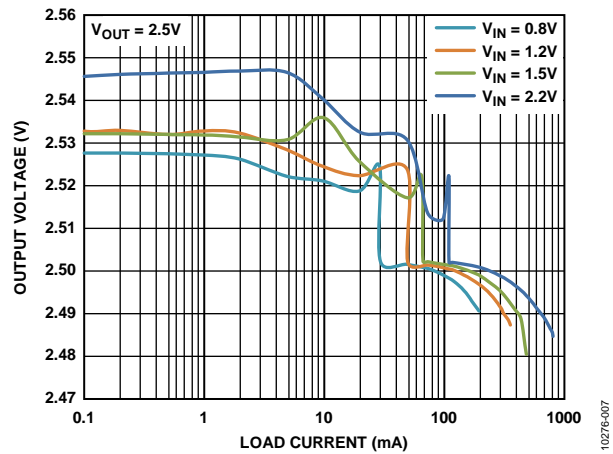

Figure 7. Auto Mode Output Voltage Load Regulation, $V_{OUT} = 2.5\text{ V}$

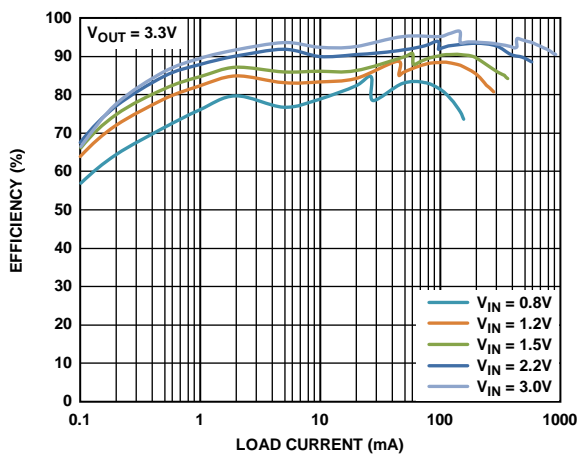

Figure 5. Auto Mode Efficiency vs. Load Current, $V_{OUT} = 3.3\text{ V}$

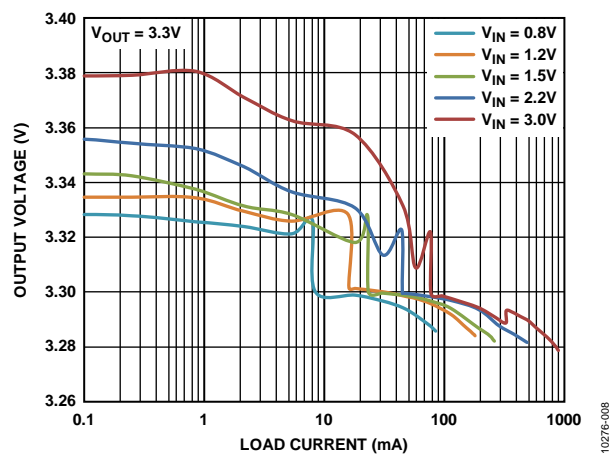

Figure 8. Auto Mode Output Voltage Load Regulation, $V_{OUT} = 3.3\text{ V}$

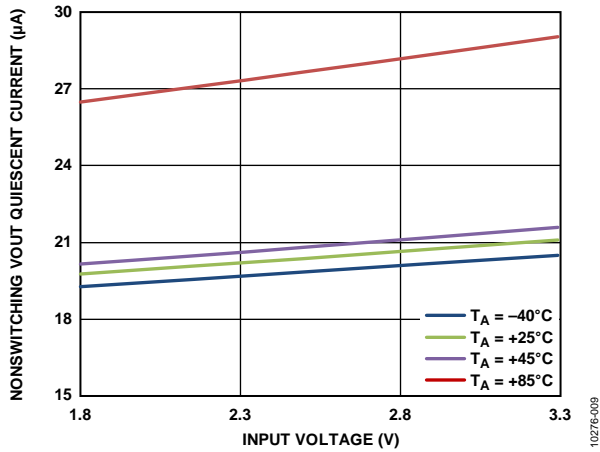

Figure 9. Nonswitching PFM Mode Quiescent Current vs. Input Voltage

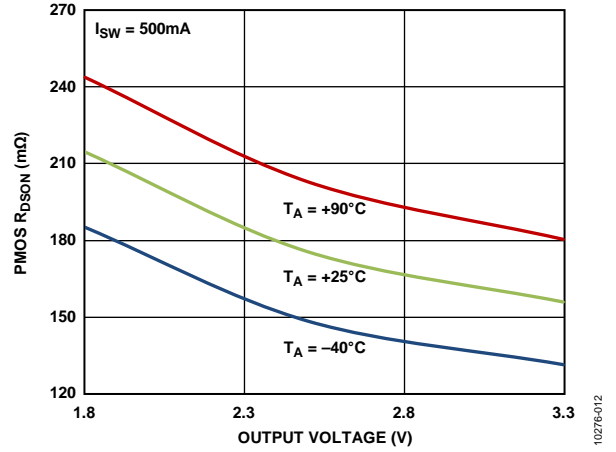

Figure 12. PMOS Drain-to-Source On Resistance

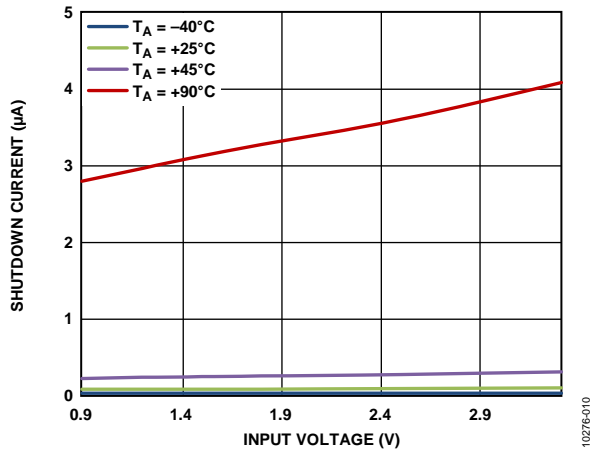

Figure 10. Shutdown Current vs. Input Voltage

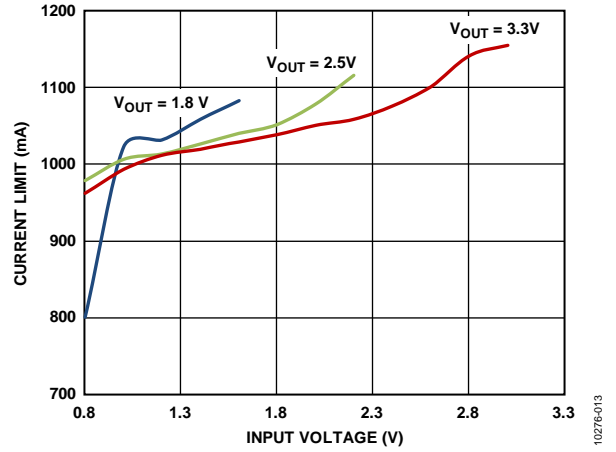

Figure 13. Switch Current Limit vs. Input Voltage

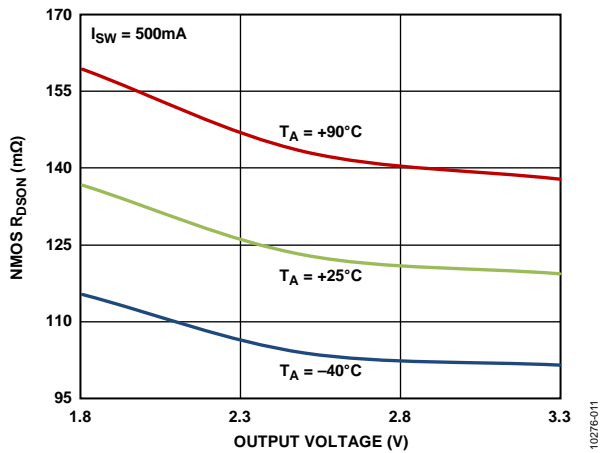

Figure 11. NMOS Drain-to-Source On Resistance

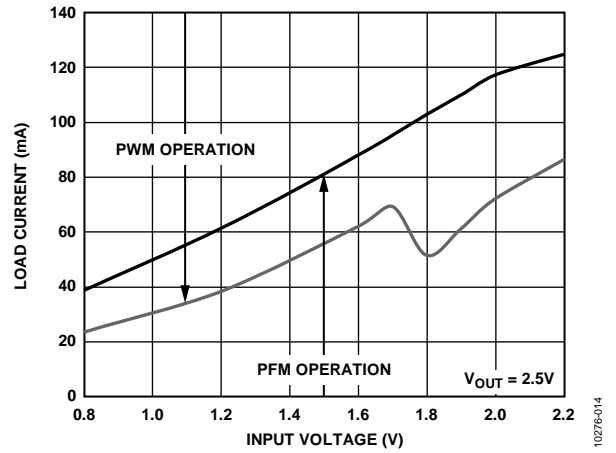

Figure 14. Auto Mode Transition Thresholds

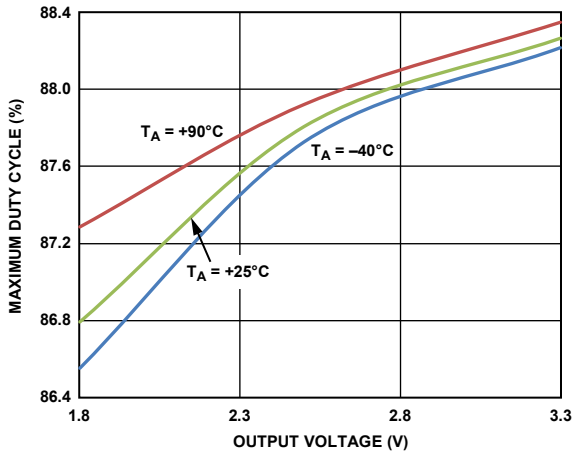

Figure 15. Maximum Duty Cycle vs. Output Voltage

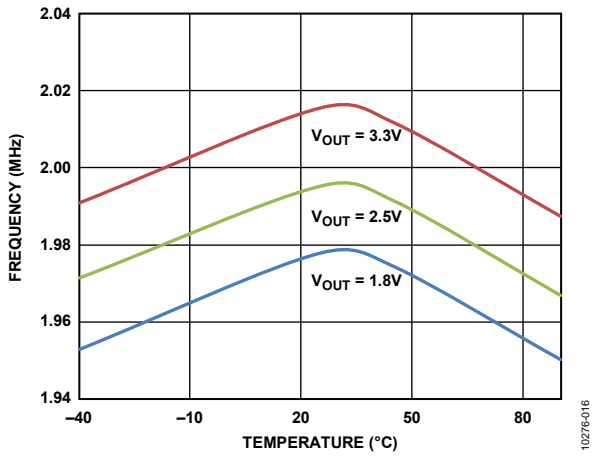

Figure 16. Frequency vs. Temperature

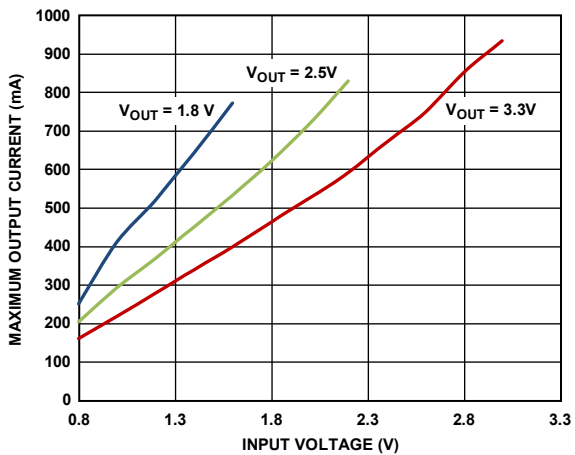

Figure 17. Maximum Output Current vs. Input Voltage

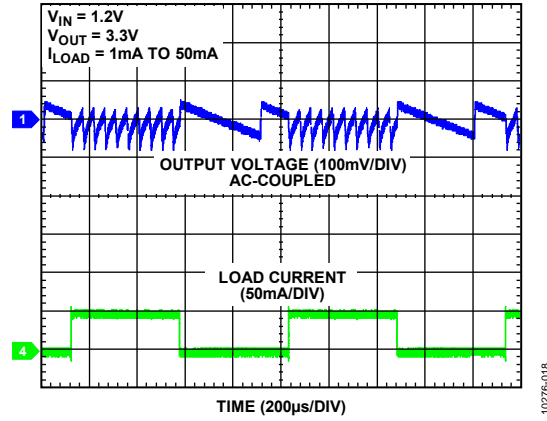

Figure 18. PFM Mode Load Transient Response (Auto Mode Part)

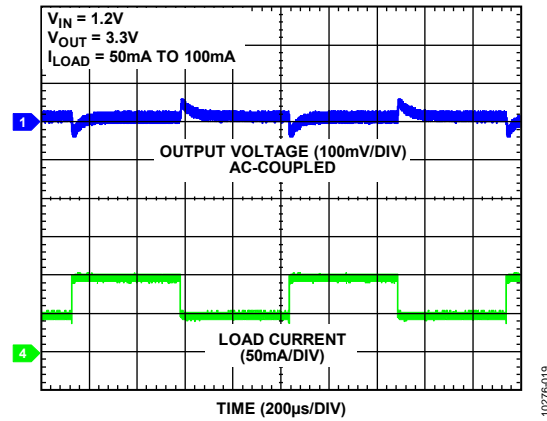

Figure 19. PWM Mode Load Transient Response (Fixed PWM Mode Part)

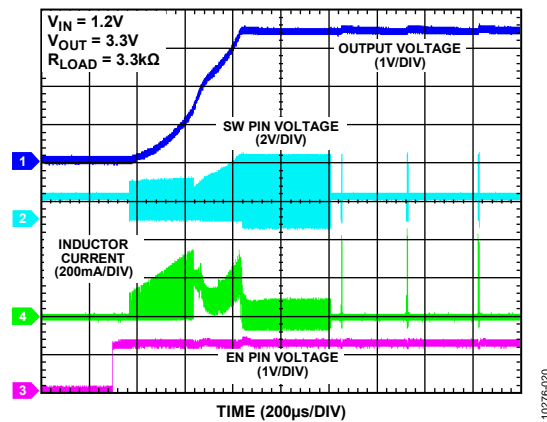

Figure 20. Startup, $R_{LOAD} = 3.3\text{ k}\Omega$

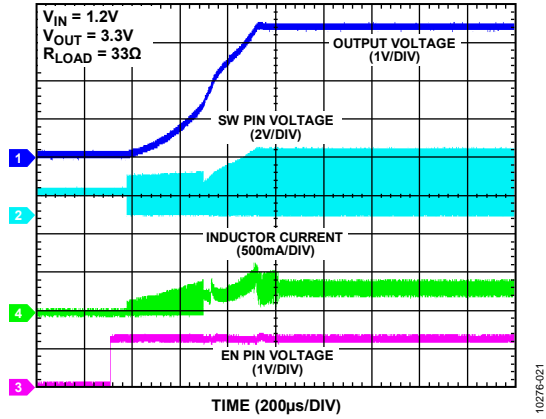

Figure 21. Startup, $R_{LOAD} = 33\ \Omega$

10276-021

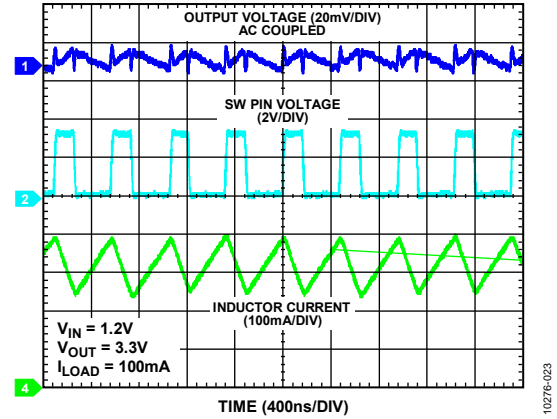

Figure 23. Typical PWM Mode Operation, $I_{LOAD} = 100\ \text{mA}$

10276-023

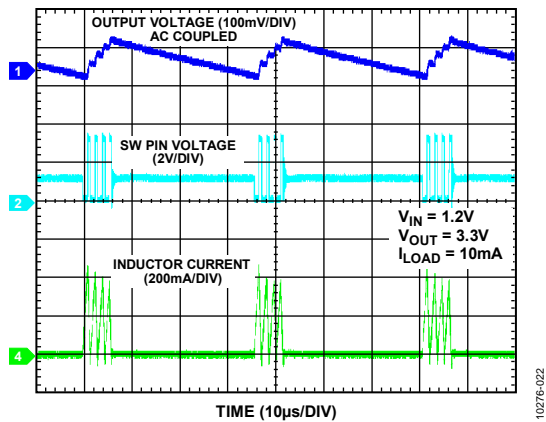

Figure 22. Typical PFM Mode Operation, $I_{LOAD} = 10\ \text{mA}$

10276-022

THEORY OF OPERATION

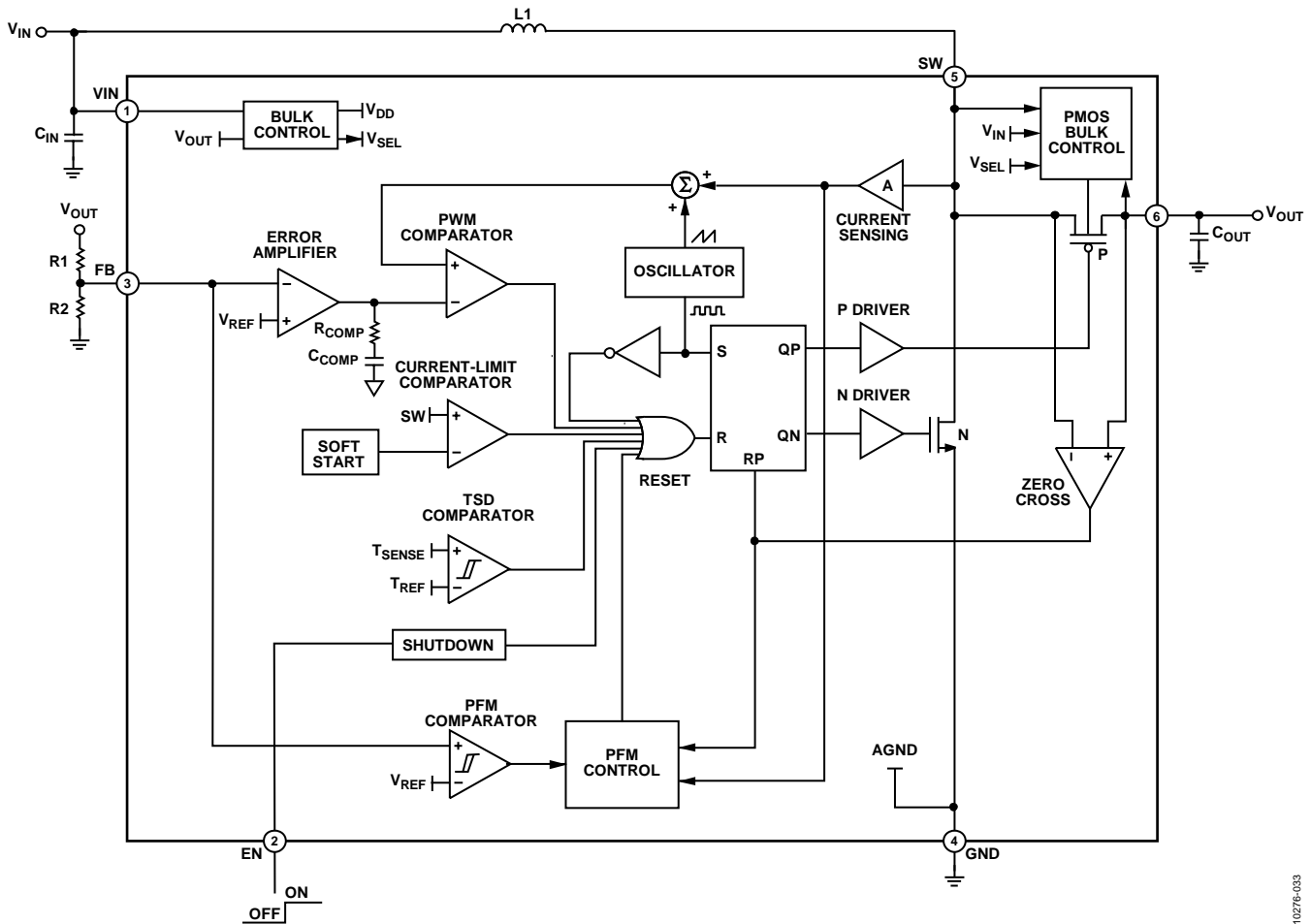

Figure 24. Block Diagram

10276-033

OVERVIEW

The **ADP1607** is a high efficiency, synchronous, fixed frequency, step-up dc-to-dc switching converter with an adjustable output voltage between 1.8 V and 3.3 V for use in portable applications.

The 2 MHz operating frequency enables the use of small footprint, low profile external components. Additionally, the synchronous rectification, internal compensation, internal fixed current limit, and current-mode architecture allow for excellent transient response and a minimal external part count. Other key features include fixed PWM and light load PFM mode options, true output isolation, thermal shutdown (TSD), and logic controlled enable.

ENABLE/SHUTDOWN

The EN input turns the **ADP1607** on or off. Connect EN to GND or logic low to shut down the part and reduce the current consumption to 0.06 μA (typical). Connect EN to VIN or logic high to enable the part. Do not exceed V_{IN} . Do not leave this pin floating.

MODES OF OPERATION

The **ADP1607** is available in a fixed PWM mode only option for noise sensitive applications or in an auto PFM-to-PWM transitioning mode option to optimize power at light loads.

Pulse-Width Modulation (PWM) Mode

The PWM version of the **ADP1607** utilizes a current-mode PWM control scheme to force the part to maintain a fixed 2 MHz fixed frequency while regulating the output voltage over all load conditions. The auto mode version of the **ADP1607** operates in PWM for higher load currents. In PWM, the output voltage is monitored at the FB pin through the external resistive voltage divider. The voltage at FB is compared to the internal 1.259 V reference by the internal error amplifier. This current-mode PWM regulation system allows fast transient response and tight output voltage regulation. PWM mode operation results in lower efficiencies than PFM mode at light loads.

Auto Mode

Auto mode is a power-saving feature that forces the auto version of the **ADP1607** to switch between PFM and PWM in response to output load changes. The auto version of the **ADP1607**

operates in PFM mode for light load currents and switches to PWM mode for medium and heavy load currents.

Pulse Frequency Modulation (PFM)

When the auto mode version of the [ADP1607](#) is operating under light load conditions, the effective switching frequency and supply current are decreased and varied using PFM to regulate the output voltage. This results in improved efficiencies and lower quiescent currents. In PFM mode, the converter only switches when necessary to keep the output voltage between the PFM comparator high output voltage threshold and the lower sleep mode exit voltage threshold. Switching stops when the upper PFM limit is reached and resumes when the lower sleep mode exit threshold is reached.

When V_{OUT} exceeds the upper PFM threshold, switching stops and the part enters sleep mode. In sleep mode, the [ADP1607](#) is mostly shut down, significantly reducing the quiescent current. The output voltage is then discharged by the load until the output voltage reaches the lower sleep mode exit threshold. After crossing the lower sleep mode exit threshold, switching resumes and the process repeats.

Mode Transition

The auto mode version of the [ADP1607](#) switches automatically between PFM and PWM modes to maintain optimal efficiency. Switching to PFM allows the converter to save power by supplying the lighter load current with fewer switching cycles. The mode transition point depends on the operating conditions. See Figure 14 for typical transition levels for $V_{OUT} = 2.5$ V. Hysteresis exists in the transition point to prevent instability and decreased efficiencies that may result if the converter oscillates between PFM and PWM for a fixed input voltage and load current.

The output voltage in PWM can be above or below the PFM voltage of that part.

INTERNAL CONTROL FEATURES

Input to Output Isolation

While in shutdown, the [ADP1607](#) manages the voltage of the bulk of the PMOS to force it off and internally isolate the path from the input to output. This allows the output to drop to ground, reducing the current consumption of the application in shutdown.

Soft Start

The [ADP1607](#) soft start sequence is designed for optimal control of the part. When EN goes high, or when the part recovers from a TSD, the start-up sequence begins. The output voltage increases through a sequence of stages to ensure that the internal circuitry is powered up in the correct order as the output voltage rises to its final value.

Current Limit

The [ADP1607](#) is designed with a fixed 1 A typical current limit that does not vary with duty cycle.

Synchronous Rectification

In addition to the N-channel MOSFET switch, the [ADP1607](#) has a P-channel MOSFET switch to build the synchronous rectifier. The synchronous rectifier improves efficiency, especially for heavy load currents, and reduces cost and board space by eliminating the need for an external Schottky diode.

Compensation

The PWM control loop of the [ADP1607](#) is internally compensated to deliver maximum performance with no additional external components. The [ADP1607](#) is designed to work with 2.2 μ H chip inductors and 10 μ F ceramic capacitors. Other values may reduce performance and/or stability.

Thermal Shutdown (TSD) Protection

The [ADP1607](#) includes thermal shutdown (TSD) protection when the part is in PWM mode only. If the die temperature exceeds 150°C (typical), the TSD protection activates and turns off the power devices. They remain off until the die temperature falls below 135°C (typical), at which point the converter restarts.

APPLICATIONS INFORMATION

SETTING THE OUTPUT VOLTAGE

The ADP1607 can be configured for output voltages between 1.8 V and 3.3 V. The output voltage is set by a resistor voltage divider, R1, from the output voltage (V_{OUT}) to the 1.259 V feedback input at FB and R2 from FB to GND (see Figure 24). Resistances between 100 k Ω and 1 M Ω are recommended.

For larger R1 and R2 values, the voltage drop due to the FB pin current (I_{FB}) on R1 becomes proportionally significant and needs to be factored in.

To account for the effect of I_{FB} for all values of R1 and R2, use the following equation to determine R1 and R2 for the desired V_{OUT} :

$$V_{OUT} = \left(1 + \frac{R1}{R2}\right)V_{FB} + I_{FB}(R1) \quad (1)$$

where:

$V_{FB} = 1.259$ V, typical

$I_{FB} = 0.1$ μ A, typical

INDUCTOR SELECTION

The ADP1607 is designed with a 2 MHz operating frequency enabling the use of small chip inductors ideal for use in applications with limited solution size constraints. The ADP1607 is designed for optimal performance with 2.2 μ H inductors, which have favorable saturation currents and lower series resistances for their given physical size.

To ensure stable and efficient performance with the ADP1607, care should be taken to select a compatible inductor with a sufficient current rating, saturation current, and low dc resistance (DCR.)

The maximum rated rms current of the inductor must be greater than the maximum input current to the regulator. Likewise, the saturation current of the chosen inductor must be able to support the peak inductor current (the maximum input current plus half the inductor ripple current) of the application.

The inductor ripple current (ΔI_L) in steady state continuous mode can be calculated as

$$\Delta I_L = \frac{V_{IN} \times D}{L \times f_{SW}} \quad (2)$$

where:

D is the duty cycle of the application.

L is the inductor value.

f_{SW} is the switching frequency of the ADP1607.

The switch duty cycle (D) is determined by the input (V_{IN}) and output (V_{OUT}) voltages with the following equation:

$$D = \frac{V_{OUT} - V_{IN}}{V_{OUT}} \quad (3)$$

Inductors with a low DCR minimize power loss and improve efficiency. DCR values below 100 m Ω are recommended.

Table 5. Suggested Inductors

Manufacturer	Part Number	Inductance (μ H)	DCR (m Ω) Typ	Current Rating (A)	Saturation Current (A)	Size (L x W x H) (mm)	Package
TDK	MLP2016S2R2M	2.2 \pm 20%	110	1.20		2.00 x 1.60 x 1.00	0806
	MLP2520S2R2S	2.2 \pm 20%	110	1.20	1.20	2.50 x 2.00 x 1.00	1008
	VLF252012MT-2R2M	2.2 \pm 20%	57	1.67	1.04	2.50 x 2.00 x 1.00	1008
	VLF302510MT-2R2M	2.2 \pm 20%	70	1.23	1.37	3.00 x 2.50 x 1.00	
	VLF302515MT-2R2M	2.2 \pm 20%	42	2.71	1.57	3.00 x 2.50 x 1.40	
Murata	LQM2HPN2R2MGO	2.2 \pm 20%	80	1.30		2.50 x 2.00 x 0.90	1008
	LQH32PN2R2NNC	2.2 \pm 30%	64	1.85		3.20 x 2.50 x 1.55	1210
Würth	74479787222	2.2 \pm 20%	80	1.50	0.70	2.50 x 2.00 x 1.00	1008
	7440430022	2.2 \pm 30%	23	2.50	2.35	4.80 x 4.80 x 2.80	
Taiyo Yuden	BRC2012T2R2MD	2.2 \pm 20%	110	1.00	1.10	2.00 x 1.25 x 1.40	0805
Toko	MDT2520-CR2R2M	2.2 \pm 20%	90	1.35		2.50 x 2.00 x 1.00	1008
	DEM2810C (1224AS-H-2R2M)	2.2 \pm 20%	85	1.10	1.40	3.20 x 3.00 x 1.00	
	DEM2815C (1226AS-H-2R2M)	2.2 \pm 20%	43	1.40	2.20	3.20 x 3.00 x 1.50	
Coilcraft	XFL3012-222	2.2 \pm 20%	81	1.9	1.6	3.00 x 3.00 x 1.20	1212
	XFL4020-222	2.2 \pm 10%	21	8.0	3.1	4.00 x 4.00 x 2.10	1515

CHOOSING THE INPUT CAPACITOR

The ADP1607 requires a 10 μF or greater input bypass capacitor (C_{IN}) between VIN and GND to supply transient currents while maintaining a constant input voltage. The value of the input capacitor can be increased without any limit for smaller input voltage ripple and better input voltage filtering. The capacitor must have a 4 V or higher voltage rating to support the maximum input operating voltage. It is recommended that C_{IN} be placed as close to the ADP1607 as possible.

Different types of capacitors can be considered, but for battery-powered applications, the best choice is the multilayer ceramic capacitor, due to its small size, low equivalent series resistance (ESR), and low equivalent series inductance (ESL). X5R or X7R dielectrics are recommended. Y5V capacitors should not be used due to their variation in capacitance over temperature. Alternatively, use a high value, medium ESR capacitor in parallel with a 0.1 μF low ESR capacitor.

CHOOSING THE OUTPUT CAPACITOR

The ADP1607 also requires a 10 μF output capacitor (C_{OUT}) to maintain the output voltage and supply current to the load. The output capacitor supplies the current to the load when the N-channel switch is turned on. Similar to C_{IN} , a 4 V or greater, low ESR, X5R or X7R ceramic capacitor is recommended for C_{OUT} . When choosing the output capacitor, it is also important to account for the loss of capacitance due to output voltage dc bias. This may result in using a capacitor with a higher rated voltage to achieve the desired capacitance value. See Figure 25 for an example of how the capacitance of a 10 μF ceramic capacitor changes with the dc bias voltage.

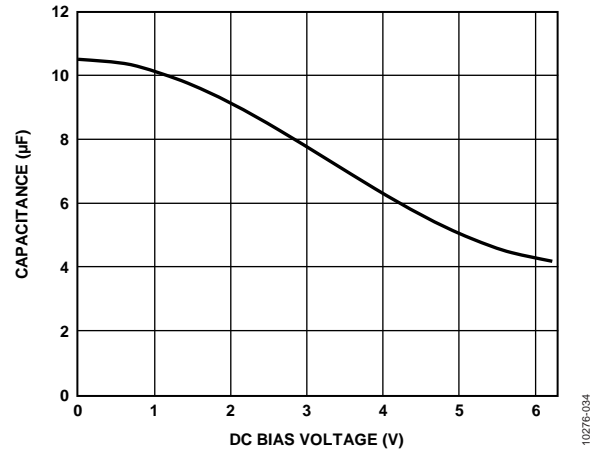

Figure 25. Typical Ceramic Capacitor Performance

The value and characteristics of the output capacitor greatly affect the output voltage ripple, transient performance, and stability of the regulator. The output voltage ripple (ΔV_{OUT}) in continuous operation is calculated as follows:

$$\Delta V_{\text{OUT}} = \frac{Q_C}{C_{\text{OUT}}} = \frac{I_{\text{OUT}} \times t_{\text{ON}}}{C_{\text{OUT}}} \quad (4)$$

where:

Q_C is the charge removed from the capacitor.

t_{ON} is the on time of the N-channel switch.

C_{OUT} is the effective output capacitance.

I_{OUT} is the output load current.

$$t_{\text{ON}} = \frac{D}{f_{\text{SW}}} \quad (5)$$

and,

$$D = \frac{V_{\text{OUT}} - V_{\text{IN}}}{V_{\text{OUT}}} \quad (6)$$

As shown in the duty cycle and output ripple voltage equations, the output voltage ripple increases with the load current.

LAYOUT GUIDELINES

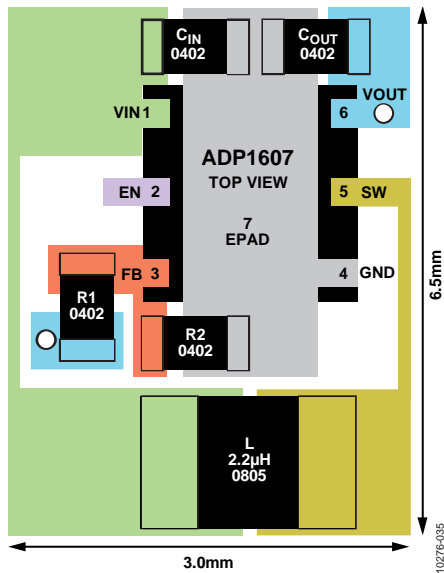

Figure 26. ADP1607 Recommended Layout Showing the Smallest Footprint

For high efficiency, good regulation, and stability, a well-designed printed circuit board layout is required.

Use the following guidelines when designing printed circuit boards (also see Figure 24 for a block diagram and Figure 2 for a pin configuration).

- Keep the low ESR input capacitor, C_{IN} , close to VIN and GND. This minimizes noise injected into the part from board parasitic inductance.
- Keep the high current path from C_{IN} through the L1 inductor to SW as short as possible.
- Place the feedback resistors, R1 and R2, as close to FB as possible to prevent noise pickup. Connect the ground of the feedback network directly to an AGND plane that makes a Kelvin connection to the GND pin.
- Avoid routing high impedance traces from feedback resistors near any node connected to SW or near the inductor to prevent radiated noise injection.
- Keep the low ESR output capacitor, C_{OUT} , close to VOUT and GND. This minimizes noise injected into the part from board parasitic inductance.
- Connect Pin 7 (EPAD) and GND to a large copper plane for proper heat dissipation.

OUTLINE DIMENSIONS

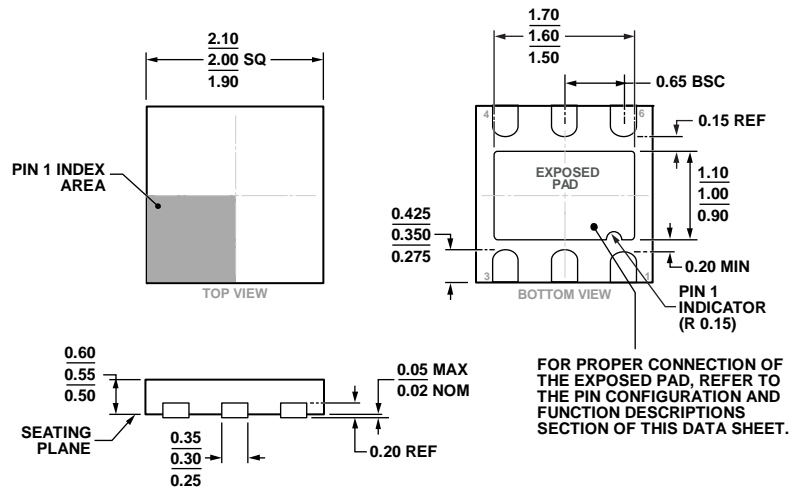

Figure 27. 6-Lead Lead Frame Chip Scale Package [LFCSP_UD]
 2.00 mm × 2.00 mm Body, Ultra Thin, Dual Lead
 (CP-6-3)

Dimensions shown in millimeters

ORDERING GUIDE

Model ¹	Output Voltage	Operating Modes	Temperature Range	Package Description	Package Option	Branding
ADP1607ACPZN-R7	Adjustable	Auto	-40°C to +85°C	6-Lead LFCSP_UD	CP-6-3	LJ5
ADP1607ACPZN001-R7	Adjustable	PWM	-40°C to +85°C	6-Lead LFCSP_UD	CP-6-3	LJ1
ADP1607-EVALZ		Auto		Evaluation Board, Automatic PFM/PWM Switching Modes		
ADP1607-001-EVALZ		PWM		Evaluation Board, PWM Mode Only		

¹ Z = RoHS Compliant Part.

NOTES

Mouser Electronics

Authorized Distributor

Click to View Pricing, Inventory, Delivery & Lifecycle Information:

[Analog Devices Inc.:](#)

[ADP1607ACPZN001-R7](#) [ADP1607ACPZN-R7](#) [ADP1607-001-EVALZ](#) [ADP1607-EVALZ](#)