

CN SERIES

PLUG-IN/PCB MOUNT SOLID STATE RELAYS

Sensata | Crydom CN Series AC & DC Output Plug-in Solid State Relays are thin 5 mm wide relays ideally suited for high density PCB applications. CN Series SSRs are designed to be pluggable into industry standard relay sockets or solderable into printed circuit boards, and they are available in ratings of 2 Amps at 24 to 280 VAC or 0.1 to 6 Amps at 0 to 100 VDC. They are UL recognized and CE compliant.



Features

- 5 mm Mini SIP SSR
- Ratings 24 VDC @ 3.5 A, 48 VDC @ 100mA, 100 VDC @ 6 A and 240 VAC @ 2 A
- DC Control, 5, 24 and 60 V
- UL & cUL recognized @ 40°C, 100K-Cycle Endurance Test
- CE & RoHS Compliant

Applications

- Automation Equipment
- Test Equipment
- Packaging equipment
- Valves & Solenoids
- Vending Equipment
- Medical Equipment

PRODUCT SELECTION

Control Voltage	3.5 A	100mA	6 A	2 A
3-12 VDC	CN024D05	CN048D05	CN100D05	CN240A05
15-30 VDC	CN024D24	CN048D24	CN100D24	CN240A24
38-72 VDC	CN024D60	CN048D60		CN240A60

SPECIFICATIONS

Output⁽¹⁾

Description	CN024Dxx	CN048Dxx	CN100Dxx	CN240Axx
Operating Voltage	0-24 VDC	0-48 VDC	0-100 VDC	24-280 VAC (47-63Hz)
Maximum Load Current @ 40°C ⁽²⁾	3.5 A	100mA	6 A	2 A
Minimum Load Current [mA]	1	1	1	70
Maximum Blocking Voltage	30 VDC	60 VDC	100 VDC	600 VDC
Maximum Surge Current [Apk]	9 (10ms)	0.3 mA (10ms)	45 (10ms)	115/120 (50/60 Hz, 1 cycle)
Maximum I ² t for fusing 50/60Hz (1/2 cycle) [A ² sec]	N/A	N/A	N/A	66/60
Typical On-State Voltage Drop @ Rated Current (V)	0.4	1.0	0.1	1.1 (peak)
Maximum Off-State Leakage Current @ Rated Voltage [mA]	0.001	0.001	0.001	4.0

Maximum PWM (Hz) ⁽³⁾	500	500	40	N.A.
Minimum Off-State dv/dt @ Maximum Rated Voltage [V/μsec]	N/A	N/A	N/A	500
Switch Configuration	N.O.	N.O.	N.O.	N.O.

Input Specifications for CN024 ⁽¹⁾

Description	CN024D05	CN024D24	CN024D60
Control Voltage Range	3-12 VDC	15-30 VDC	38-72 VDC
Must Turn On Voltage	3 VDC	15 VDC	38 VDC
Must Turn Off Voltage	1 VDC	5 VDC	5 VDC
Nominal Input Impedance	500 Ohm	3.5K Ohm	20K Ohm
Typical Input Current	10mA @ 5 VDC	7mA @ 24 VDC	3mA @ 60 VDC
Typical Turn-On Time [μsec]	120	350	400
Typical Turn-Off Time [μsec]	100	80	70

Input Specifications for CN048 ⁽¹⁾

Description	CN048D05	CN048D24	CN048D60
Control Voltage Range	3-12 VDC	15-30 VDC	38-72 VDC
Must Turn On Voltage	3 VDC	15 VDC	38 VDC
Must Turn Off Voltage	1 VDC	5 VDC	5 VDC
Nominal Input Impedance	1.25K Ohm	3K Ohm	20K Ohm
Typical Input Current	12mA @ 5 VDC	8mA @ 24 VDC	3mA @ 60 VDC
Typical Turn-On Time [μsec]	20	20	20
Typical Turn-Off Time [μsec]	130	130	130

Input Specifications for CN100 ⁽¹⁾

Description	CN100D05	CN100D24
Control Voltage Range	3-12 VDC	15-30 VDC
Must Turn On Voltage	3 VDC	15 VDC
Must Turn Off Voltage	1 VDC	5 VDC
Nominal Input Impedance	420 Ohm	3K Ohm
Typical Input Current	12mA @ 5 VDC	8mA @ 24 VDC
Maximum Turn-On Time [μsec]	400	800
Maximum Turn-Off Time [μsec]	180	180

Input Specifications for CN240 ⁽¹⁾

Description	CN240A05	CN240A24	CN240A60
Control Voltage Range	3-12 VDC	15-30 VDC	38-72 VDC
Must Turn On Voltage	3 VDC	15 VDC	38 VDC
Must Turn Off Voltage	1 VDC	5 VDC	5 VDC
Nominal Input Impedance	240 Ohm	3.5K Ohm	20K Ohm
Typical Input Current	15mA @ 5 VDC	6mA @ 24 VDC	4mA @ 60 VDC
Typical Turn-On Time [μsec] ⁽⁴⁾	1/2 Cycle	1/2 Cycle	1/2 Cycle
Typical Turn-Off Time [μsec]	1/2 Cycle	1/2 Cycle	1/2 Cycle



GENERAL SPECIFICATIONS (1)

Description	Parameters
Dielectric Strength, Input/Output/Base (50/60Hz) (5)	2.5KV
Maximum Capacitance, Input/Output	1.5 pF
Ambient Operating Temperature Range	-20 to 80°C
Ambient Storage Temperature Range	-20 to 100°C
Weight (typical)	0.14 oz. (4.05g)
Housing Material	UL 94 V0
Overvoltage Category	III
Pollution Degree	2
Degree of protection (Encapsulation)	IP67



THERMAL DERATE INFORMATION

CN024Dxx

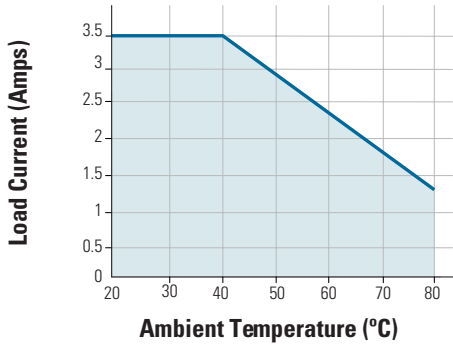

CN240Axx

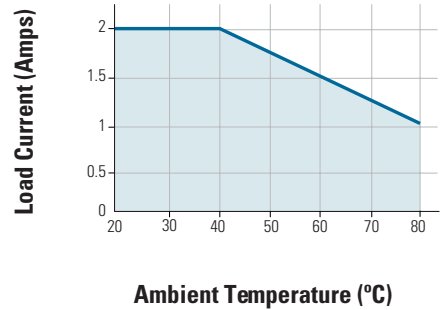

CN048Dxx

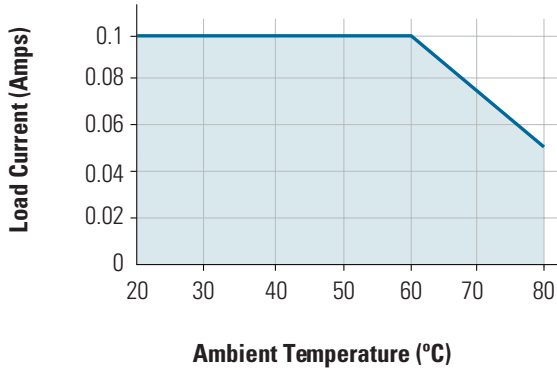

CN100Dxx

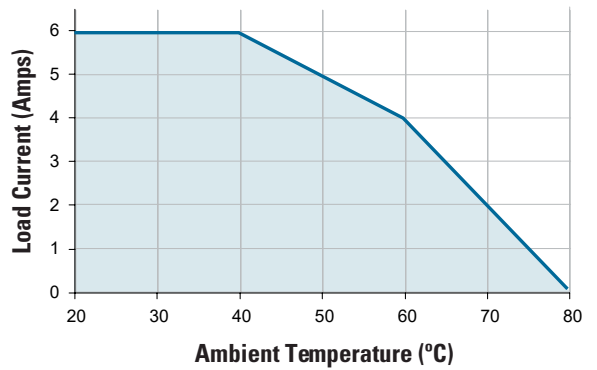

BLOCK DIAGRAM, CN240AXX, DC CONTROL - AC OUTPUT

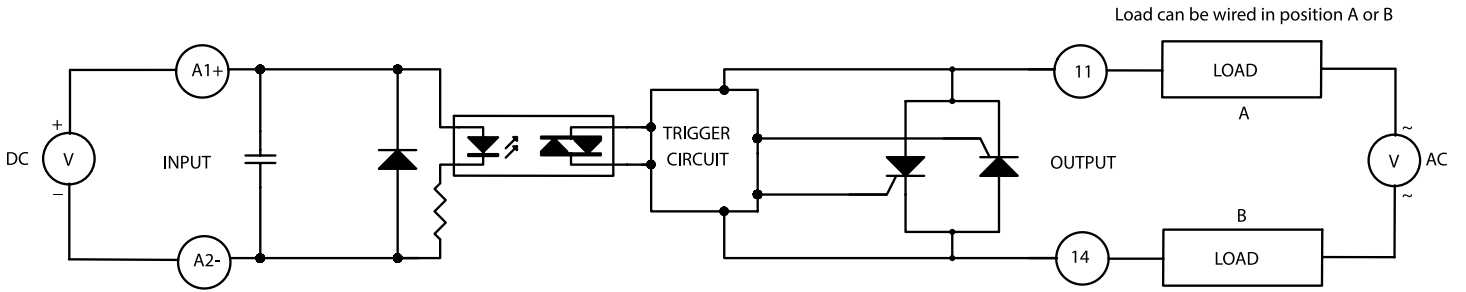

BLOCK DIAGRAM, CN100DXX, CN024DXX DC CONTROL - DC OUTPUT

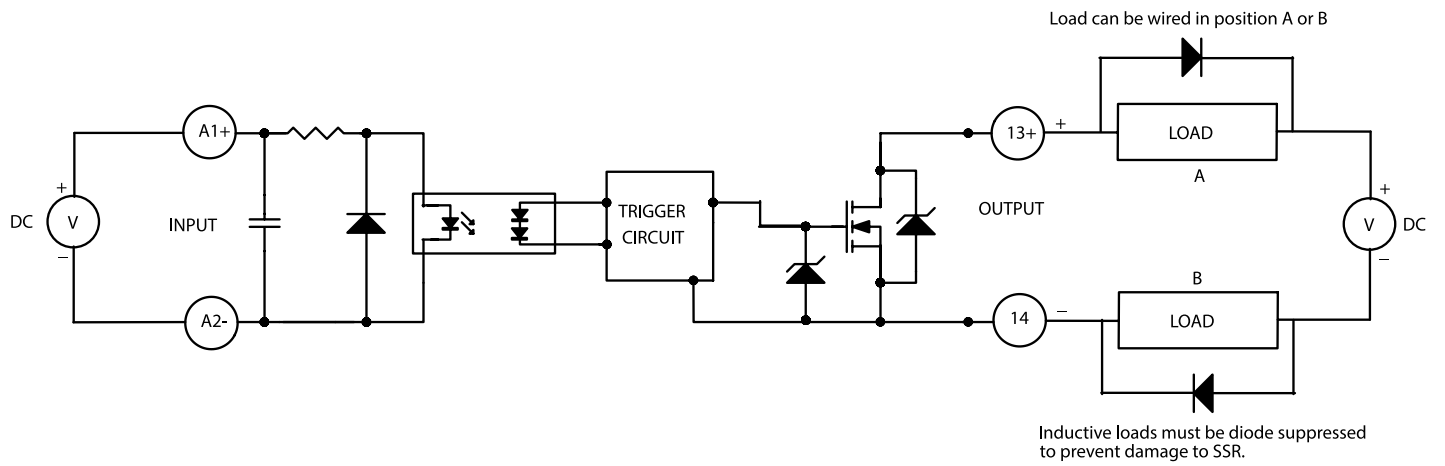

BLOCK DIAGRAM, CN048DXX, DC CONTROL - DC OUTPUT

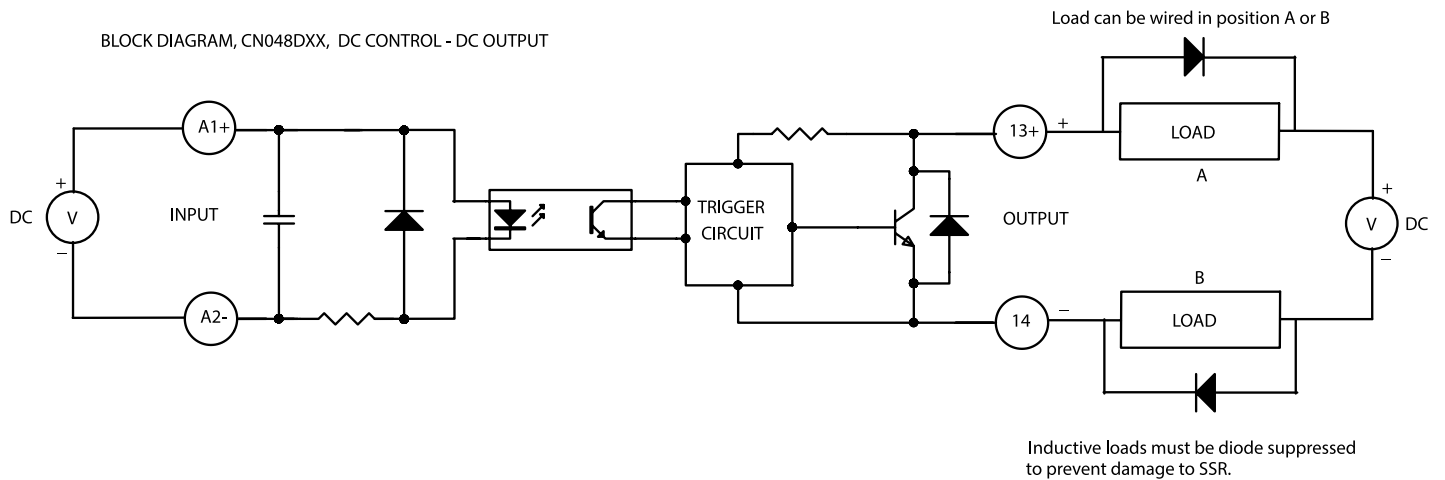



MECHANICAL SPECIFICATIONS

Tolerances: ± 0.02 in / 0.5 mm All dimensions are in: inches [millimeters]

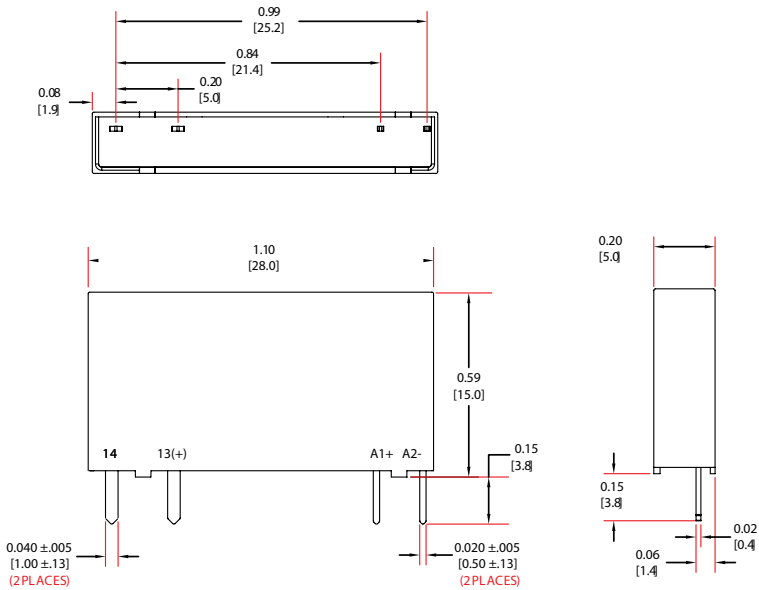

INSTALLATION INSTRUCTIONS

Mounting on a Socket

The CN Series relays can be mounted in a DIN rail socket. The DRSCN sockets provide a convenient and easy way to install CN Series Solid State Relays on a standard 35 mm DIN rail.

Please read all installation instructions before using the sockets and relays.

- Match CN Series SSR to appropriate DRSCN socket part number to create an assembly (See Relay/Socket Compatibility)
- Insert the CN SSR on the socket
- Mount the socket on the DIN rail
- Wire the socket to the control side. AWG #24-14 solid, AWG #24-14 stranded (0.2-2.1 mm²)
- Wire the socket to the load side. AWG #24-14 solid, AWG #24-14 stranded (0.2-2.1 mm²)
- Maximum torque: 5-7 lb-in (0.56-0.8 Nm)
- If multiple units are installed be sure to follow derating curves for assemblies

TABLE 1. Relay/Socket Compatibility

SSR Part. No.	DRSCN30	DRSCN24	DRSCN05
CN024D05	•		•
CN024D24	•	•	
CN048D05	•		•
CN048D24	•	•	
CN240A05	•		•
CN240A24	•	•	
CN100D05	•		•
CN100D24	•	•	

- Installing a CN Series solid state relay in a socket that does not have matching input/output specifications may result in damage to either the relay, socket, or both, and/or in non-operation.
- Maximum output rating for DRSCN Series sockets is 250 V, 6 Amps regardless of chosen SSR.
- Proper polarity must be observed for DC input control voltage sockets being terminal A1+ positive with respect to terminal A2-.
- For AC loads, the AC line can be wired to either DRS socket terminal 11 or terminal 14. The AC load may also be wired on either the line or neutral side of the SSR. For DC loads, the proper polarity must be observed for the power supply, load and DRS socket with terminal 13 being positive with respect to terminal 14.
- DC inductive loads must be diode suppressed.
- All terminals feature screw M3 slotted drive.

WIRING DIAGRAMS

DRSCN30

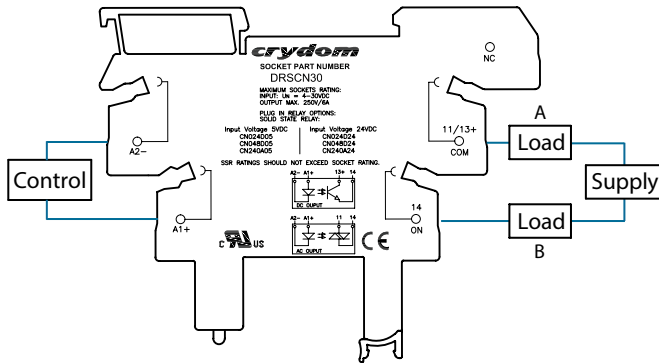

DRSCN05, DRSCN24

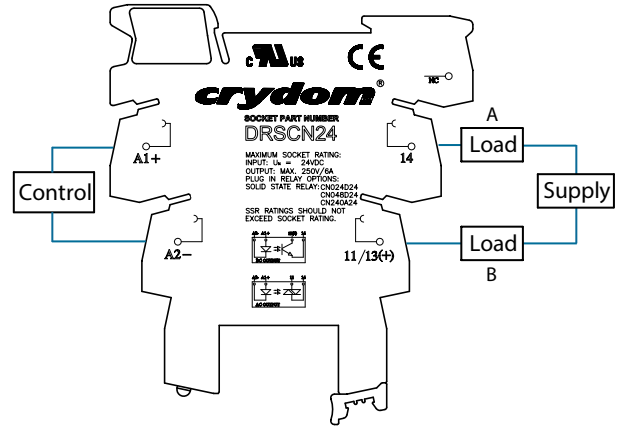

Mounting on a Printed Circuit Board

When different kinds of packages are mounted on PC board, temperature rise at soldering lead is dependent on package size. Therefore, set the lower temperature soldering condition than the conditions of item "Soldering profile", and confirm the temperature condition of actual usage before soldering.

When soldering condition exceeds our recommendation, the SSR characteristics may be adversely affected. It may occur package crack or power electronics failures because of thermal expansion nonconformity and resin strength reduction.

Solder creepage, wettability, or soldering strength will be affected by the soldering condition or used soldering type.

Soldering Profile

The classification temperature (T_c) of this product is 245°C (473°F) and the maximum dwell time (T_p) is 30 seconds, the body temperature of this device may be ($T_c - 5$)°C or greater. The classification temperature sets the Maximum Body Temperature allowed for this device during lead-free reflow processes, maximum 1 cycle for reflow is allowed. For any other processes, the guidelines of J-STD-020 must be observed.

Manual soldering method

Temperature: 350°C (662°F) to 400°C (752°F), within 3s, electrical power 30 to 60W

Recommended PCB hole layout:

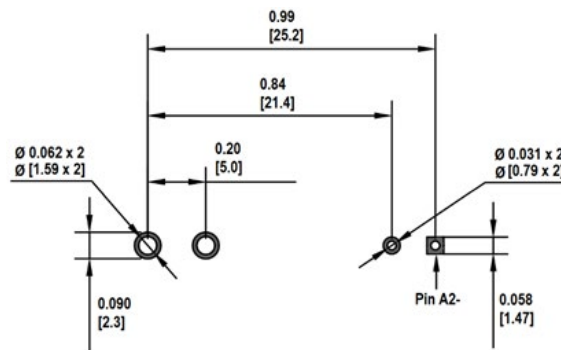

Tolerances: ± 0.02 in / 0.5 mm All dimensions are in: inches [millimeters]



ORDERING OPTIONS

Example : CN240A24R

Series	CN	240A	24	R
Operating Voltage				
Control Voltage				
Switching Mode (AC Output only)				

240A: 240 VAC, 2 A
024D: 24 VDC, 3.5 A
048D: 48 VDC, 0.1 A
100D: 100 VDC, 6 A

05: 3-12 VDC
24: 15-30 VDC
60: 38-72 VDC

Blank: Zero Voltage Turn-On
R: Random Turn-On

Required for valid part number
 For options only and not required for valid part number



ACCESSORIES

DRSCN Series DIN Rail Mountable Sockets

DRSCN05, DRSCN24, DRSCN30



- Sockets are fully compatible with CN series SSRs
- 6.2 mm wide
- LED status indicator
- Socket clip fits all standard 35 mm
- DIN rail profiles
- UL & cUL recognized, CE & RoHS compliant

RELAY/SOCKET COMPATIBILITY ^{G, H}



SSR PN	DR Socket PN	Socket Input Voltage
CN024D05 CN048D05 CN100D05 CN240A05	DRSCN05	3-12 VDC
CN024D24 CN048D24 CN100D24 CN240A24	DRSCN24	15-30 VDC
CN024D05 CN024D24 CN048D05 CN048D24 CN100D05 CN100D24 CN240A05 CN240A24	DRSCN30	4-30 VDC

^G Installing a CN Series solid state relay in a socket that does not have matching input/output specifications may result in non-operation or damage to either the relay, socket or both.

^H Maximum output rating for DRSCN Series sockets is 250 V / 6 Amps regardless of chosen SSR.

ID Marker Strips

CNLB, CNLN, CNL2

		
Black Strips Part no.: CNLB	Numbered 1 to 10 Strips Part no.: CNLN	Numbered 11 to 20 Strips Part no.: CNL2
A package of 10 plastic strips comprising 10 individual unprinted markers which can be placed on sockets' terminal block for easy identification during the use of multiple units.	A package of 10 plastic strips comprising 10 markers printed individually from 1 to 10 which can be placed on sockets' terminal block for easy identification during the use of multiple units.	A package of 10 plastic strips comprising 10 markers printed individually from 11 to 20 which can be placed on sockets' terminal block for easy identification during the use of multiple units.



GENERAL NOTES

- ⁽¹⁾ All parameters at 25°C unless otherwise specified.
- ⁽²⁾ See derating curves
- ⁽³⁾ Operating above the specified frequency will damage the SSR (DC output only).
- ⁽⁴⁾ Turn-on time for random turn-on version is 0.1 ms.
- ⁽⁵⁾ 3.75KV for CN048Dxx



AGENCY APPROVALS & CERTIFICATIONS

Designed in accordance with the requirements of IEC 62314





WARNINGS



RISK OF MATERIAL DAMAGE AND HOT ENCLOSURE

- The product's side panels may be hot, allow the product to cool before touching
- Follow proper mounting instructions including torque values
- Do not allow liquids or foreign objects to enter this product

Failure to follow these instructions can result in serious injury, or equipment damage.



HAZARD OF ELECTRIC SHOCK, EXPLOSION OR ARC FLASH

- Disconnect all power before installing or working with this equipment
- Verify all connections and replace all covers before turning on power

Failure to follow these instructions will result in death or serious injury.

Sensata Technologies, Inc. ("Sensata") data sheets are solely intended to assist designers ("Buyers") who are developing systems that incorporate Sensata products (also referred to herein as "components"). Buyer understands and agrees that Buyer remains responsible for using its independent analysis, evaluation and judgment in designing Buyer's systems and products. Sensata data sheets have been created using standard laboratory conditions and engineering practices. Sensata has not conducted any testing other than that specifically described in the published documentation for a particular data sheet. Sensata may make corrections, enhancements, improvements and other changes to its data sheets or components without notice.

Buyers are authorized to use Sensata data sheets with the Sensata component(s) identified in each particular data sheet. HOWEVER, NO OTHER LICENSE, EXPRESS OR IMPLIED, BY ESTOPPEL OR OTHERWISE TO ANY OTHER SENSATA INTELLECTUAL PROPERTY RIGHT, AND NO LICENSE TO ANY THIRD PARTY TECHNOLOGY OR INTELLECTUAL PROPERTY RIGHT, IS GRANTED HEREIN. SENSATA DATA SHEETS ARE PROVIDED "AS IS". SENSATA MAKES NO WARRANTIES OR REPRESENTATIONS WITH REGARD TO THE DATA SHEETS OR USE OF THE DATA SHEETS, EXPRESS, IMPLIED OR STATUTORY, INCLUDING ACCURACY OR COMPLETENESS. SENSATA DISCLAIMS ANY WARRANTY OF TITLE AND ANY IMPLIED WARRANTIES OF MERCHANTABILITY, FITNESS FOR A PARTICULAR PURPOSE, QUIET ENJOYMENT, QUIET POSSESSION, AND NON-INFRINGEMENT OF ANY THIRD PARTY INTELLECTUAL PROPERTY RIGHTS WITH REGARD TO SENSATA DATA SHEETS OR USE THEREOF.

All products are sold subject to Sensata's terms and conditions of sale supplied at www.sensata.com SENSATA ASSUMES NO LIABILITY FOR APPLICATIONS ASSISTANCE OR THE DESIGN OF BUYERS' PRODUCTS. BUYER ACKNOWLEDGES AND AGREES THAT IT IS SOLELY RESPONSIBLE FOR COMPLIANCE WITH ALL LEGAL, REGULATORY AND SAFETY-RELATED REQUIREMENTS CONCERNING ITS PRODUCTS, AND ANY USE OF SENSATA COMPONENTS IN ITS APPLICATIONS, NOTWITHSTANDING ANY APPLICATIONS-RELATED INFORMATION OR SUPPORT THAT MAY BE PROVIDED BY SENSATA.

Mailing Address: Sensata Technologies, Inc., 529 Pleasant Street, Attleboro, MA 02703, USA.

CONTACT US

Americas

+1 (877) 502 5500
sales.crydom@sensata.com

Europe, Middle East & Africa

+44 (1202) 416170
ssr-info.eu@sensata.com

Asia Pacific

sales.isasia@list.sensata.com
 China +86 (21) 2306 1500
 Japan +81 (45) 277 7117
 Korea +82 (31) 601 2004
 India +91 (80) 67920890
 Rest of Asia +886 (2) 27602006
 ext 2808

Mouser Electronics

Authorized Distributor

Click to View Pricing, Inventory, Delivery & Lifecycle Information:

Sensata:

[CN024D05](#) [CN024D24](#) [CN024D60](#) [CN048D05](#) [CN048D24](#) [CN048D60](#) [CN240A05](#) [CN240A24](#) [CN240A60](#)
[CN240A05R](#) [CN240A24R](#) [CN240A60R](#) [CN100D05](#) [CN100D24](#)