

FEATURES

Passive I/Q mixer

RF and LO range: 2.5 GHz to 8.5 GHz

Wide IF range: dc to 4 GHz

Single-ended RF, LO, and IF

Conversion loss (downconverter): 9 dB (typical)

Image rejection (downconverter): 25 dBc (typical)

SSB noise figure (downconverter): 11.5 dB (typical)

Input IP3 (downconverter): 20 dBm (typical)

Input P1dB compression point (downconverter): 13 dBm (typical)

Input IP2 (downconverter): 58 dBm (typical)

RF to IF isolation (downconverter): 22 dB (typical)

LO to RF isolation (downconverter): 48 dB (typical)

LO to IF isolation (downconverter): 38 dB (typical)

Amplitude balance (downconverter): ± 0.5 dB (typical)

Phase balance (downconverter): $\pm 5^\circ$ (typical)

RF return loss: 13 dB (typical)

LO return loss 13 dB (typical)

IF return loss: 17 dB (typical)

Exposed pad, 4 mm \times 4 mm, 24-terminal, ceramic LCC package

APPLICATIONS

Test and measurement instrumentation

Military, aerospace, and radar

Direct conversion receivers

GENERAL DESCRIPTION

The HMC8193 is a passive, in phase/quadrature (I/Q), monolithic microwave integrated circuit (MMIC) mixer that can be used either as an image rejection mixer for receiver operations, or as a single-sideband upconverter for transmitter operations from 2.5 GHz to 8.5 GHz. The inherent I/Q architecture of the HMC8193 offers excellent image rejection and thereby eliminates the need for expensive filtering of unwanted sidebands. The mixer also provides excellent local oscillator (LO) to radio frequency (RF) and LO to intermediate frequency (IF) isolation and reduces the effect of LO leakage to ensure signal integrity.

FUNCTIONAL BLOCK DIAGRAM

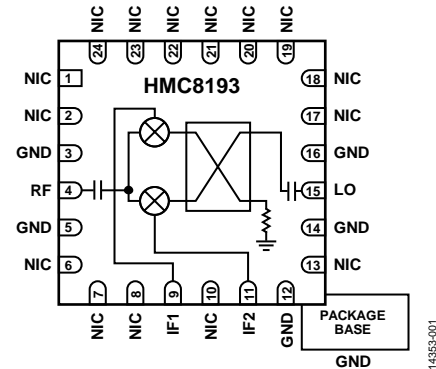

Figure 1.

Being the HMC8193 is a passive mixer, it does not require any dc power sources. The device offers a lower noise figure than an active mixer, ensuring superior dynamic range for high performance and precision applications.

The HMC8193 is fabricated on a gallium arsenide (GaAs), metal semiconductor field effect transistor (MESFET) process and uses Analog Devices, Inc., mixer cells and a 90° hybrid. It is available in a compact, 4 mm \times 4 mm, 24-lead LCC package and operates over the -40°C to $+85^\circ\text{C}$ temperature range. An evaluation board for this device is also available.

TABLE OF CONTENTS

Features	1	Upconverter Performance.....	18
Applications.....	1	Isolation and Return Loss	24
Functional Block Diagram	1	IF Bandwidth	26
General Description	1	Amplitude and Phase Imbalance	27
Revision History	2	Spurious and Harmonics Performance	29
Specifications.....	3	Theory of Operation	32
Absolute Maximum Ratings.....	4	Applications Information	33
Thermal Resistance	4	Soldering Information and Recommended Land Pattern	34
ESD Caution.....	4	Evaluation Board Information.....	35
Pin Configuration and Function Descriptions.....	5	Outline Dimensions	36
Interface Schematics.....	5	Ordering Guide	36
Typical Performance Characteristics	6		
Downconverter Performance.....	6		

REVISION HISTORY

5/2018—Rev. A to Rev. B

Changes to Applications Information Section.....	33
--	----

1/2018—Rev. 0 to Rev. A

Changes to Features.....	1
Changed Single-Sideband (SSB) Noise Figure Parameter from 15 dB Typical to 11.5 dB Typical, Table 1	3
Changes to Ordering Guide	36

8/2017—Revision 0: Initial Version

SPECIFICATIONS

$T_A = 25^\circ\text{C}$, IF = 100 MHz, and LO drive = 18 dBm; all measurements performed as downconverter with lower sideband selected, unless otherwise noted.

Table 1.

Parameter	Symbol	Min	Typ	Max	Unit
RADIO FREQUENCY	RF	2.5		8.5	GHz
LOCAL OSCILLATOR	LO				
Frequency		2.5		8.5	GHz
Drive Level			18		dBm
INTERMEDIATE FREQUENCY	IF	DC		4	GHz
RF PERFORMANCE AS DOWNCONVERTER					
Conversion Loss			9	11	dB
Image Rejection		23	25		dBc
Single-Sideband (SSB) Noise Figure			11.5		dB
Input Third-Order Intercept	IP3	16	20		dBm
Input 1 dB Compression Point	P1dB		13		dBm
Input Second-Order Intercept	IP2		58		dBm
Isolation					
RF to IF		13	22		dB
LO to RF		37	48		dB
LO to IF		30	38		dB
Amplitude Balance			± 0.5		dB
Phase Balance			± 5		Degrees
RF PERFORMANCE AS UPCONVERTER					
Conversion Loss			8.5		dB
Sideband Rejection			23		dBc
Input Third-Order Intercept	IP3		21		dBm
RETURN LOSS PERFORMANCE					
RF			13		dB
LO			13		dB
IFx			17		dB

ABSOLUTE MAXIMUM RATINGS

Table 2.

Parameter	Rating
RF Input Power	21 dBm
LO Input Power	25 dBm
IF Input Power	21 dBm
IF Source/Sink Current	6 mA
Continuous Power Dissipation, P_{DISS} ($T_A = 85^\circ\text{C}$, Derate 12.44 mW/ $^\circ\text{C}$ Above 85°C)	1120 mW
Maximum Junction Temperature	175°C
Maximum Peak Reflow Temperature (MSL3)	260°C
Operating Temperature Range	-40°C to $+85^\circ\text{C}$
Storage Temperature Range	-65°C to $+150^\circ\text{C}$
Electrostatic Discharge (ESD) Sensitivity	
Human Body Model (HBM)	2000 V
Field Induced Charged Device Model (FICDM)	1250 V

Stresses at or above those listed under Absolute Maximum Ratings may cause permanent damage to the product. This is a stress rating only; functional operation of the product at these or any other conditions above those indicated in the operational section of this specification is not implied. Operation beyond the maximum operating conditions for extended periods may affect product reliability.

THERMAL RESISTANCE

Thermal performance is directly linked to printed circuit board (PCB) design and operating environment. Careful attention to PCB thermal design is required.

Table 3. Thermal Resistance

Package Type	θ_{JA}	θ_{JC}	Unit
E-24-1 ¹	120	80	$^\circ\text{C}/\text{W}$

¹ Thermal impedance simulated values are based on a JEDEC 252P test board with 4×4 thermal vias. See JEDEC JESD51-12 for additional information.

ESD CAUTION



ESD (electrostatic discharge) sensitive device.

Charged devices and circuit boards can discharge without detection. Although this product features patented or proprietary protection circuitry, damage may occur on devices subjected to high energy ESD. Therefore, proper ESD precautions should be taken to avoid performance degradation or loss of functionality.

PIN CONFIGURATION AND FUNCTION DESCRIPTIONS

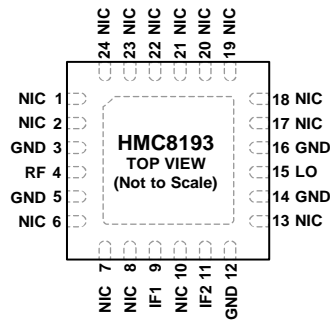

NOTES
 1. NOT INTERNALLY CONNECTED. NO CONNECTION IS REQUIRED. THESE PINS CAN BE CONNECTED TO RF/DC GROUND WITHOUT AFFECTING PERFORMANCE.
 2. EXPOSED PAD. THE EXPOSED PAD MUST BE CONNECTED TO RF/DC GROUND.

14353-002

Figure 2. Pin Configuration

Table 4. Pin Function Descriptions

Pin No.	Mnemonic	Description
1, 2, 6 to 8, 10, 13, 17 to 24	NIC	Not Internally Connected. No connection is required. These pins can be connected to RF/dc ground without affecting performance.
3, 5, 12, 14, 16	GND	Ground Connect. These pins and package bottom must be connected to RF/dc ground. See Figure 3 for the interface schematic.
4	RF	Radio Frequency. This pin is ac-coupled and matched to 50 Ω. See Figure 5 for the interface schematic.
9	IF1	First and Quadrature Intermediate Frequency. This pin is dc-coupled. For applications not requiring operation to dc, dc block this port externally using a series capacitor with a value selected to pass the necessary IF frequency range. For operation to dc, this pin must not source or sink more than 6 mA of current; otherwise, the device does not function and may fail. See Figure 4 for the interface schematic.
11	IF2	Second Quadrature Intermediate Frequency. This pin is dc-coupled. For applications not requiring operation to dc, dc block this port externally using a series capacitor with a value selected to pass the necessary IF frequency range. For operation to dc, this pin must not source or sink more than 6 mA of current; otherwise, the device does not function and may fail. See Figure 4 for the interface schematic.
15	LO	Local Oscillator. This pin is ac-coupled and matched to 50 Ω. See Figure 6 for the interface schematic.
	EPAD	Exposed Pad. The exposed pad must be connected to RF/dc ground.

INTERFACE SCHEMATICS



Figure 3. GND Interface Schematic

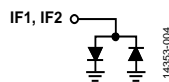

Figure 4. IF1, IF2 Interface Schematic

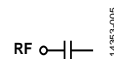

Figure 5. RF Interface Schematic

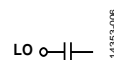

Figure 6. LO Interface Schematic

TYPICAL PERFORMANCE CHARACTERISTICS

DOWNCONVERTER PERFORMANCE

Downconverter Performance at IF = 100 MHz, Lower Sideband

Data taken at LO drive = 18 dBm and TA = 25°C, unless otherwise noted.

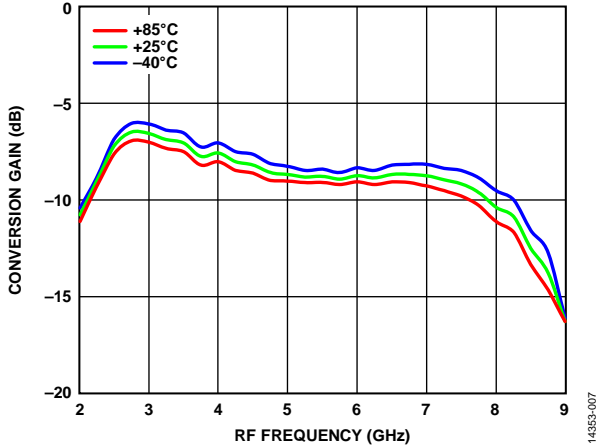

Figure 7. Conversion Gain vs. RF Frequency at Various Temperatures

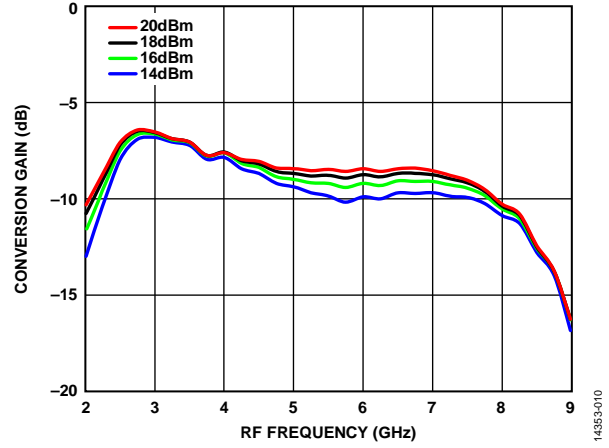

Figure 10. Conversion Gain vs. RF Frequency at Various LO Drives

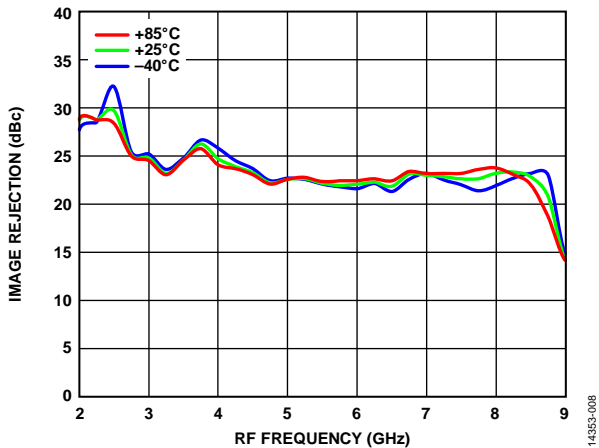

Figure 8. Image Rejection vs. RF Frequency at Various Temperatures

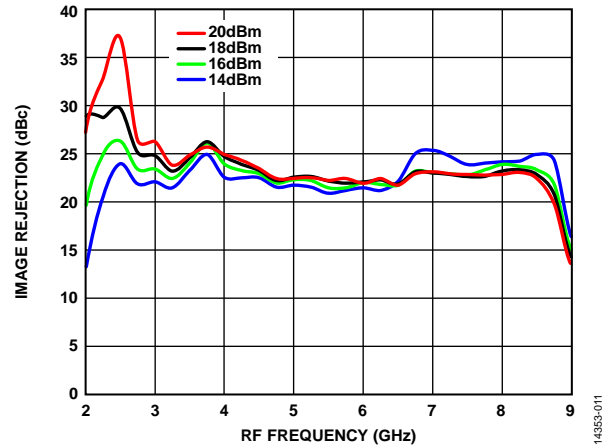

Figure 11. Image Rejection vs. RF Frequency at Various LO Drives

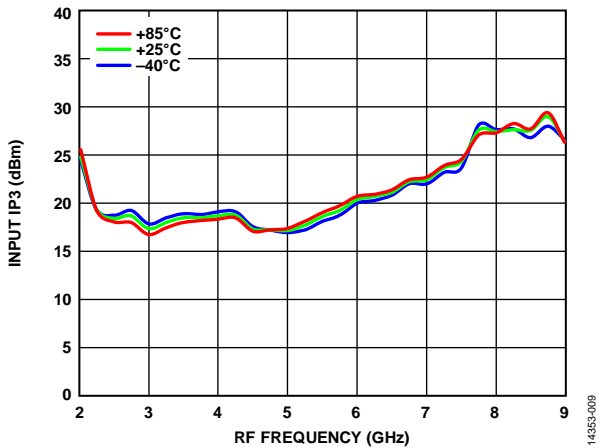

Figure 9. Input IP3 vs. RF Frequency at Various Temperatures

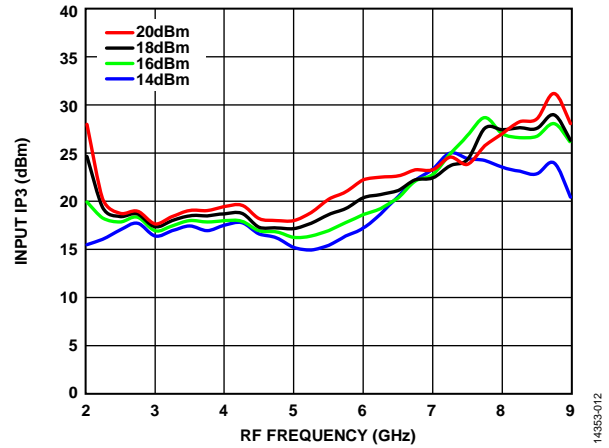

Figure 12. Input IP3 vs. RF Frequency at Various LO Drives

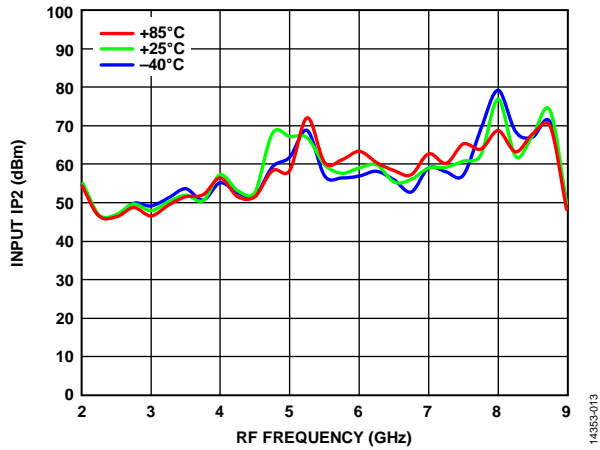

Figure 13. Input IP2 vs. RF Frequency at Various Temperatures

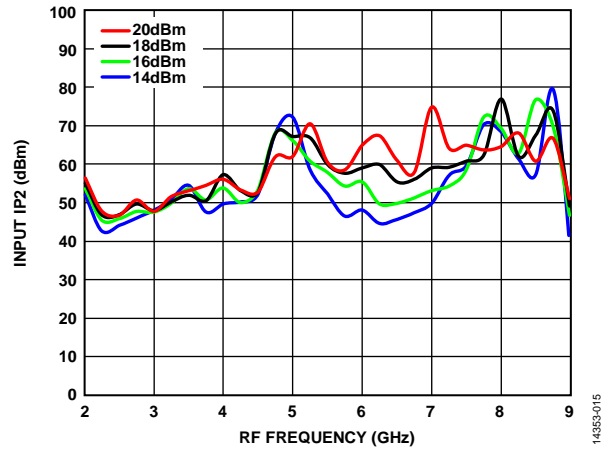

Figure 15. Input IP2 vs. RF Frequency at Various LO Drives

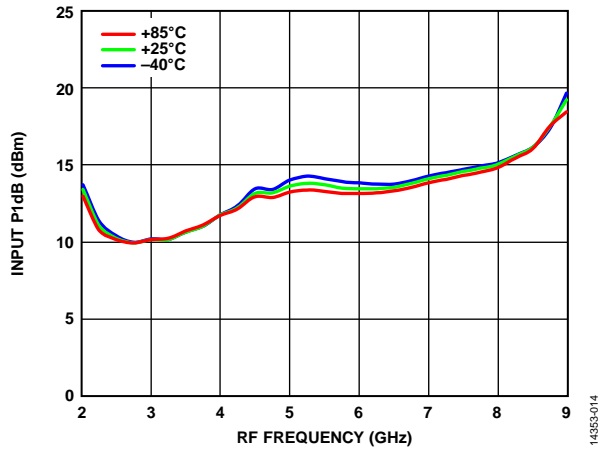

Figure 14. Input P1dB vs. RF Frequency at Various Temperatures

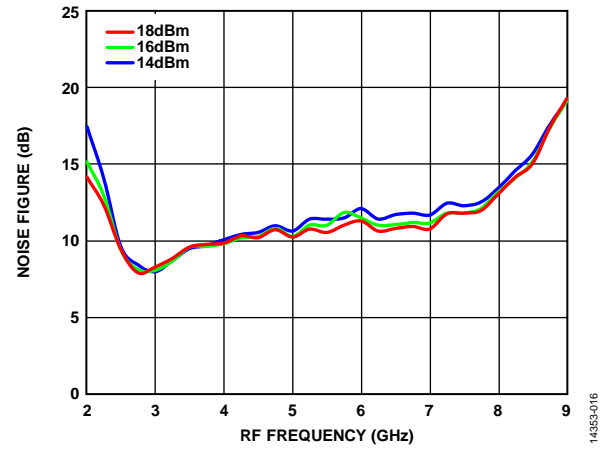

Figure 16. Noise Figure vs. RF Frequency at Various LO Drives

Downconverter Performance at IF = 1000 MHz, Lower Sideband

Data taken at LO drive = 18 dBm and T_A = 25°C, unless otherwise noted.

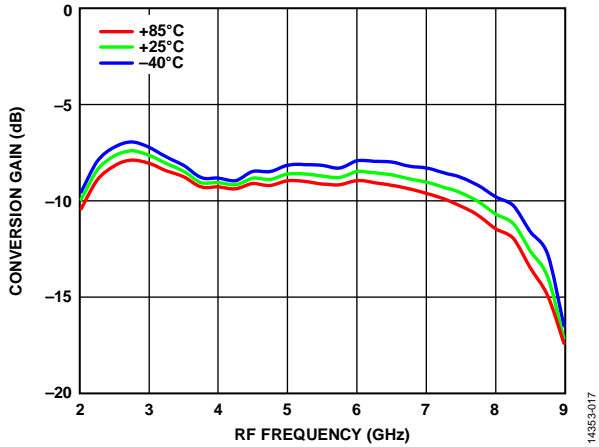

Figure 17. Conversion Gain vs. RF Frequency at Various Temperatures

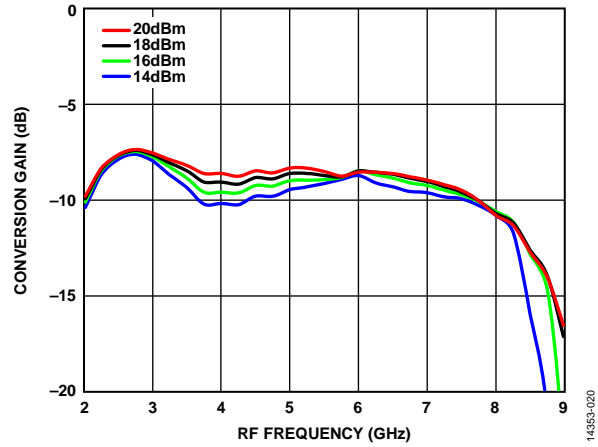

Figure 20. Conversion Gain vs. RF Frequency at Various LO Drives

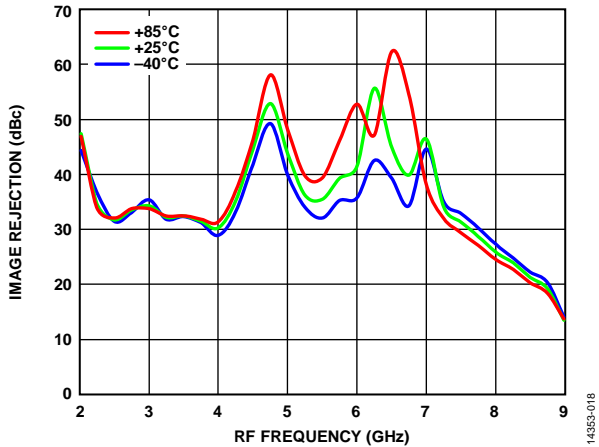

Figure 18. Image Rejection vs. RF Frequency at Various Temperatures

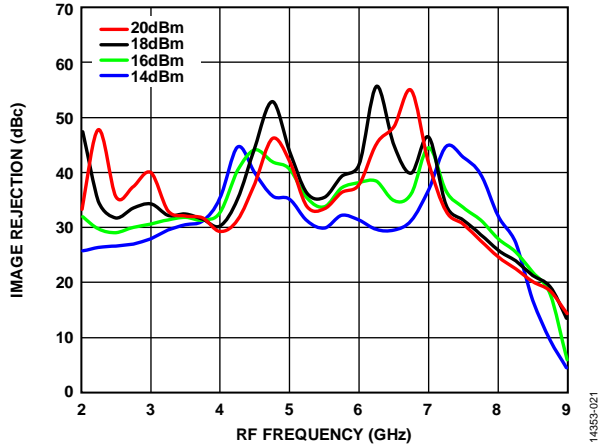

Figure 21. Image Rejection vs. RF Frequency at Various LO Drives

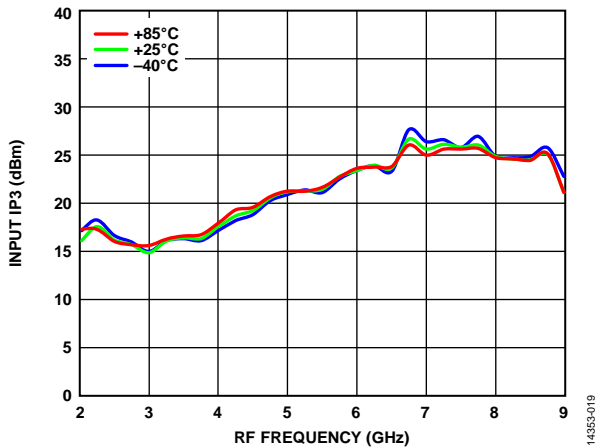

Figure 19. Input IP3 vs. RF Frequency at Various Temperatures

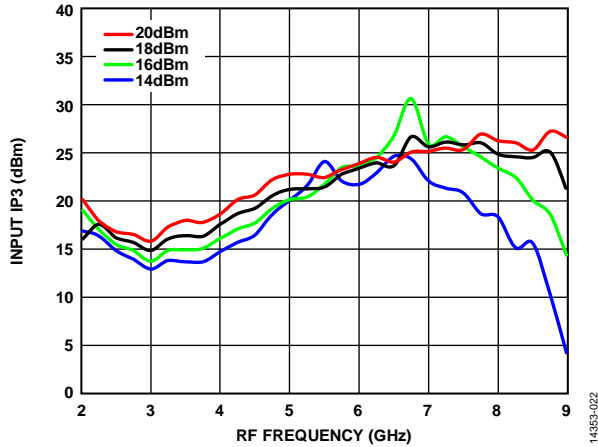

Figure 22. Input IP3 vs. RF Frequency at Various LO Drives

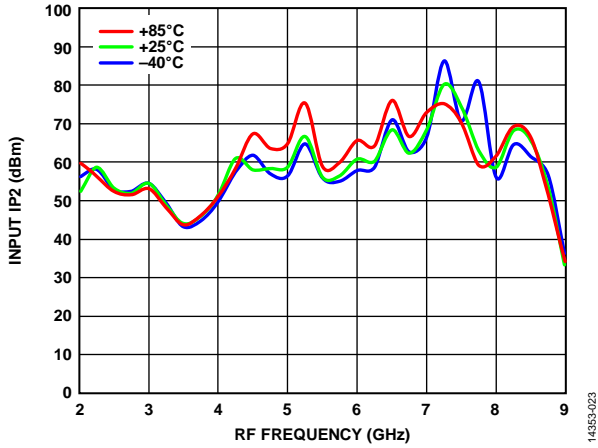

Figure 23. Input IP2 vs. RF Frequency at Various Temperatures

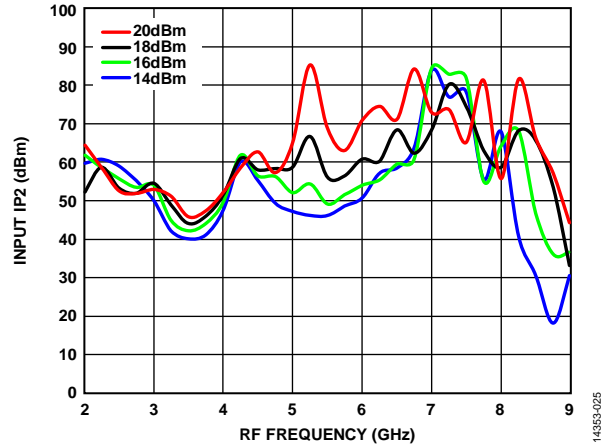

Figure 25. Input IP2 vs. RF Frequency at Various LO Drives

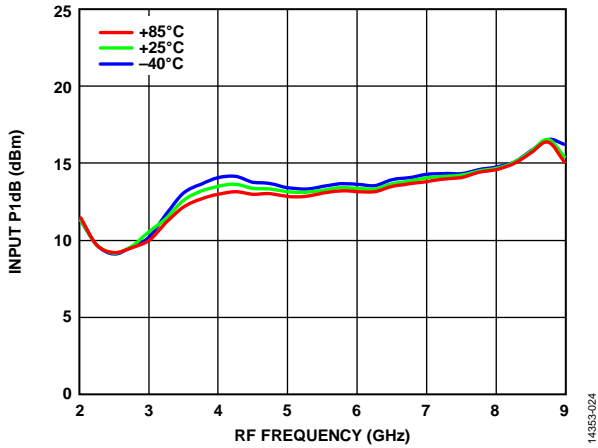

Figure 24. Input P1dB vs. RF Frequency at Various Temperatures

Downconverter Performance at IF = 3500 MHz, Lower Sideband

Data taken at LO drive = 18 dBm and T_A = 25°C, unless otherwise noted.

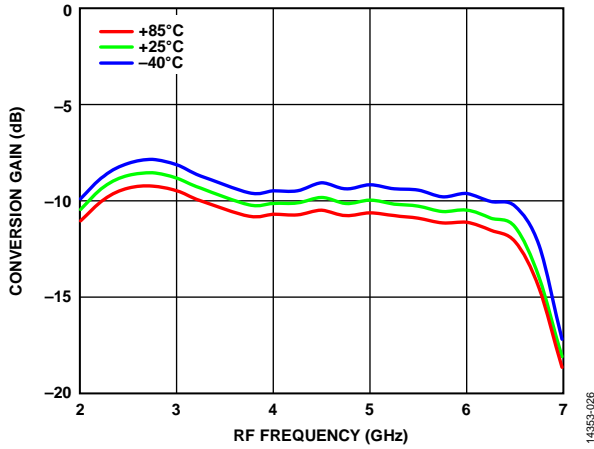

Figure 26. Conversion Gain vs. RF Frequency at Various Temperatures

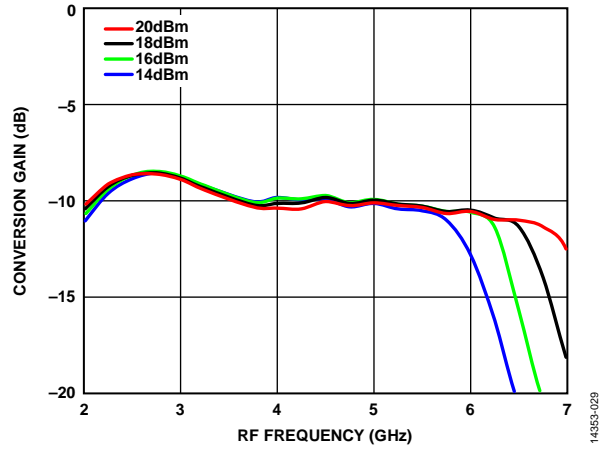

Figure 29. Conversion Gain vs. RF Frequency at Various LO Drives

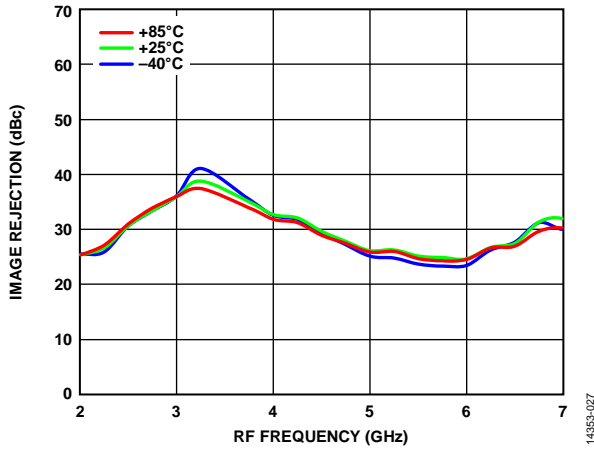

Figure 27. Image Rejection vs. RF Frequency at Various Temperatures

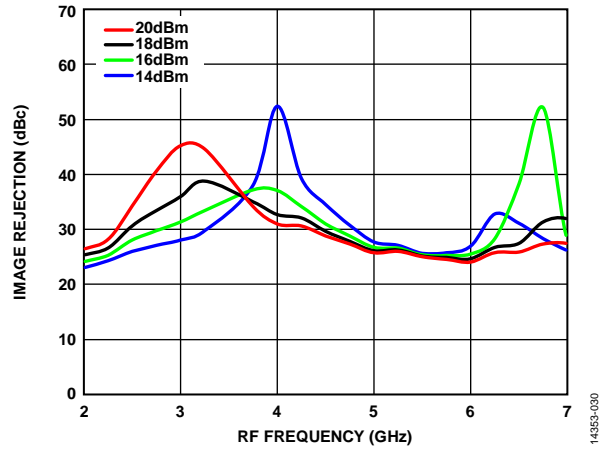

Figure 30. Image Rejection vs. RF Frequency at Various LO Drives

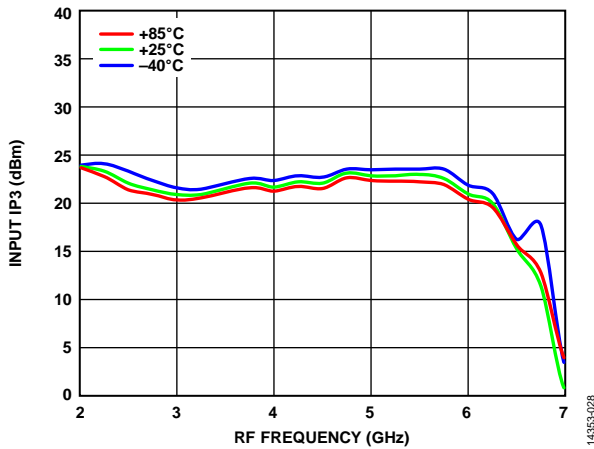

Figure 28. Input IP3 vs. RF Frequency at Various Temperatures

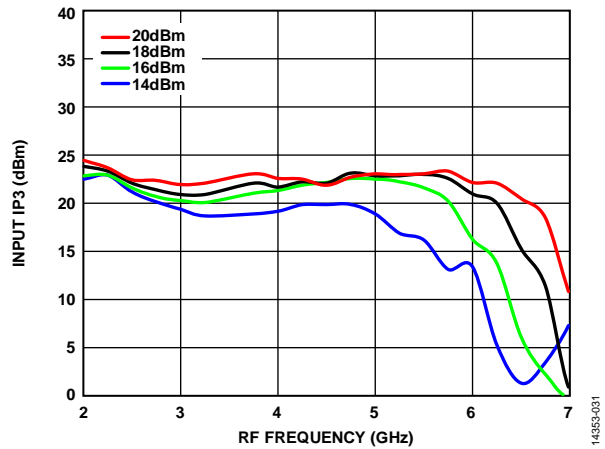

Figure 31. Input IP3 vs. RF Frequency at Various LO Drives

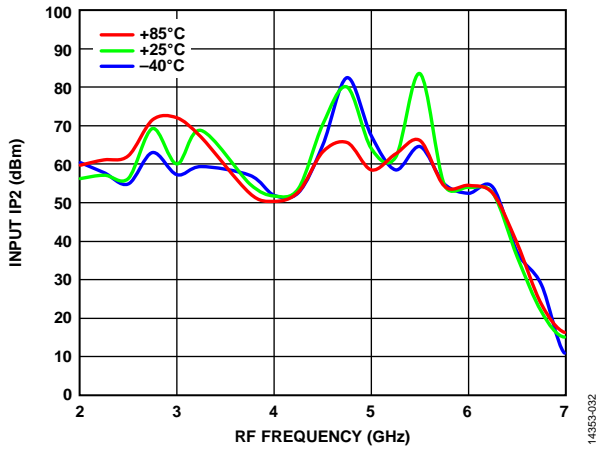

Figure 32. Input IP2 vs. RF Frequency at Various Temperatures

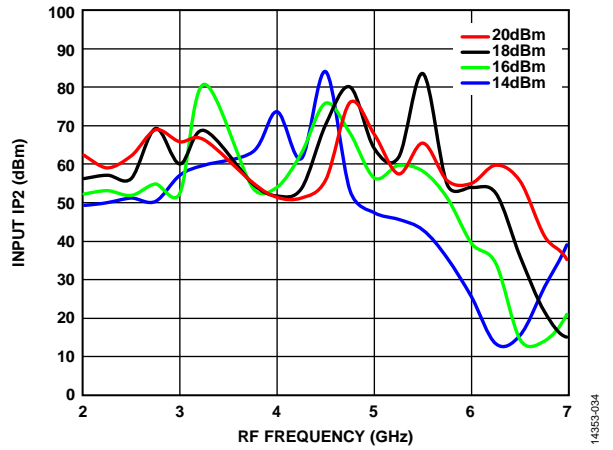

Figure 34. Input IP2 vs. RF Frequency at Various LO Drives

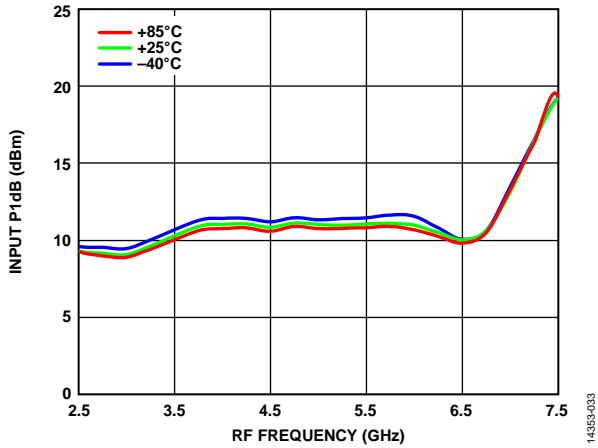

Figure 33. Input P1dB vs. RF Frequency at Various Temperatures

Downconverter Performance at IF = 100 MHz, Upper Sideband

Data taken at LO drive = 18 dBm and T_A = 25°C, unless otherwise noted.

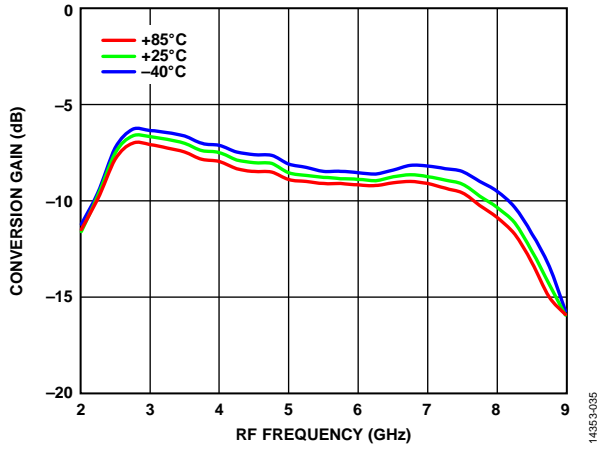

Figure 35. Conversion Gain vs. RF Frequency at Various Temperatures

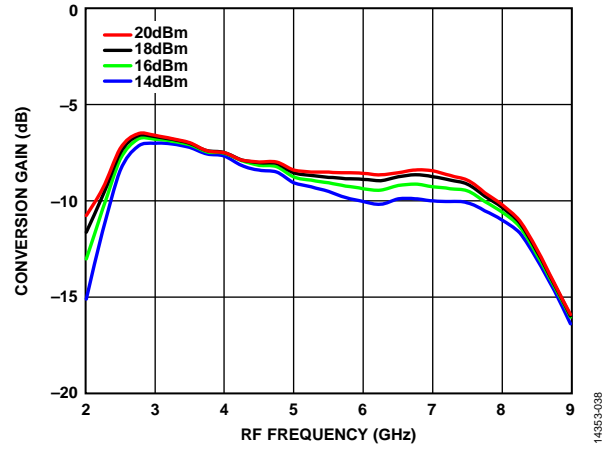

Figure 38. Conversion Gain vs. RF Frequency at Various LO Drives

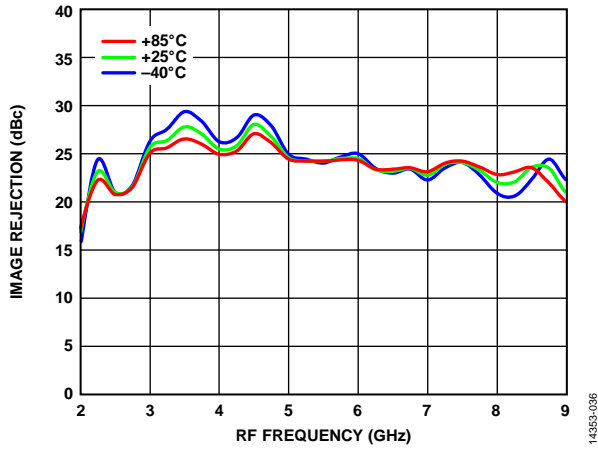

Figure 36. Image Rejection vs. RF Frequency at Various Temperatures

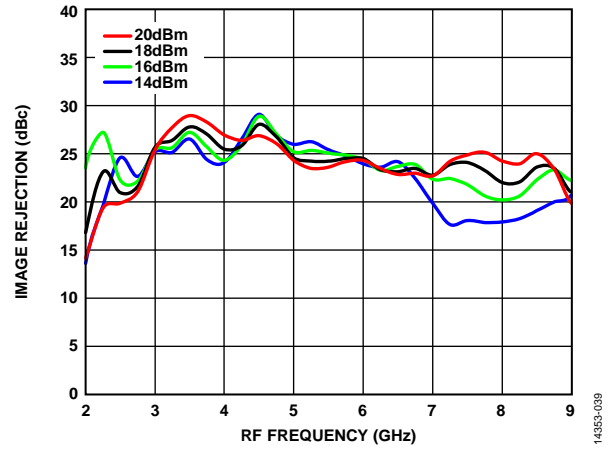

Figure 39. Image Rejection vs. RF Frequency at Various LO Drives

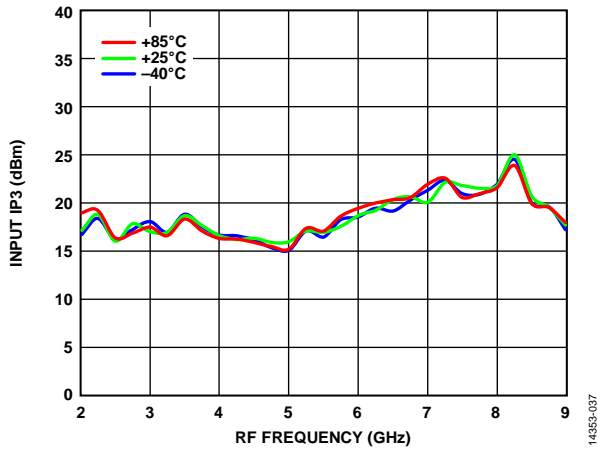

Figure 37. Input IP3 vs. RF Frequency at Various Temperatures

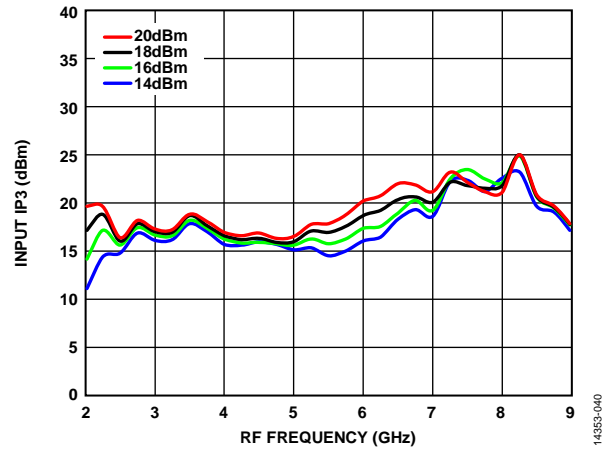

Figure 40. Input IP3 vs. RF Frequency at Various LO Drives

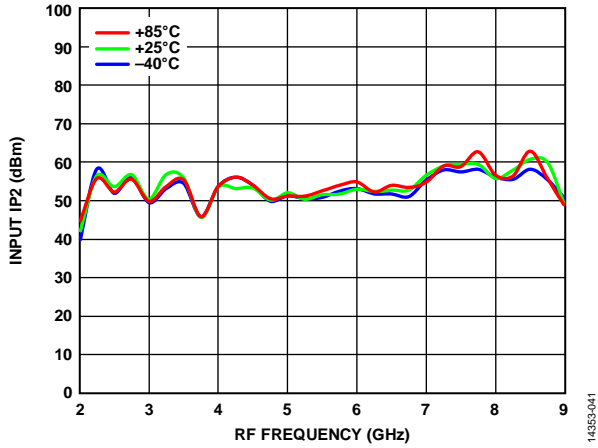

Figure 41. Input IP2 vs. RF Frequency at Various Temperatures

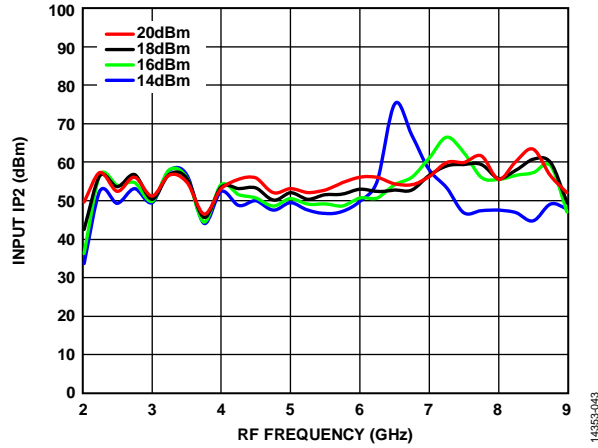

Figure 43. Input IP2 vs. RF Frequency at Various LO Drives

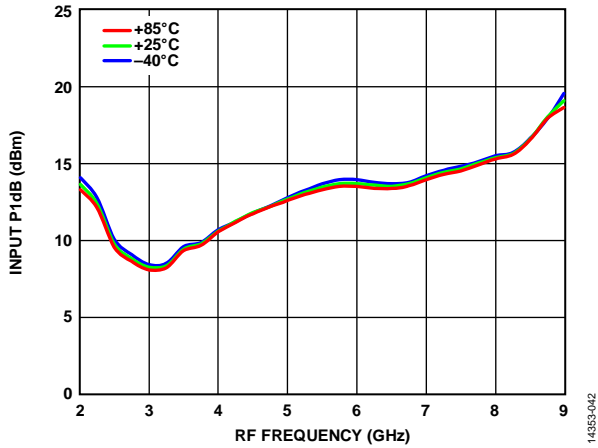

Figure 42. Input P1dB vs. RF Frequency at Various Temperatures

143353-041

143353-043

143353-042

Downconverter Performance at IF = 1000 MHz, Upper Sideband

Data taken at LO drive = 18 dBm and T_A = 25°C, unless otherwise noted.

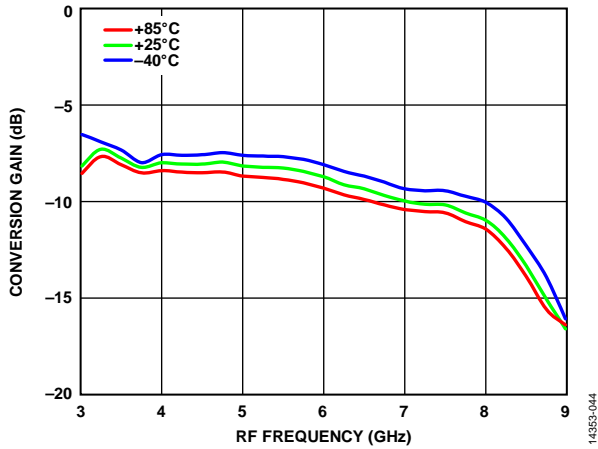

Figure 44. Conversion Gain vs. RF Frequency at Various Temperatures

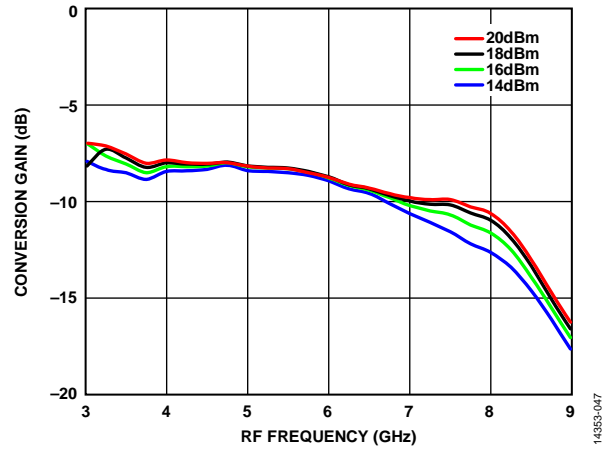

Figure 47. Conversion Gain vs. RF Frequency at Various LO Drives

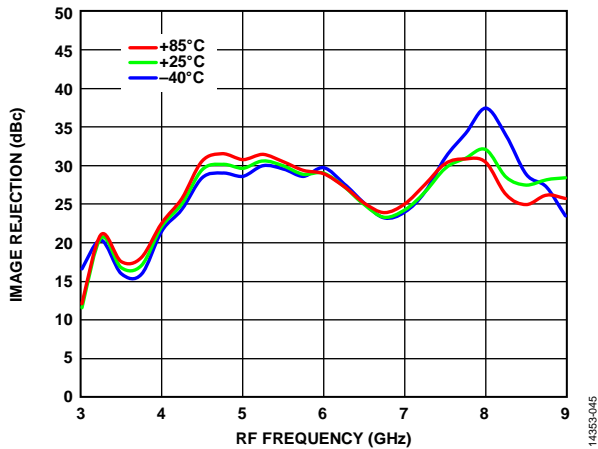

Figure 45. Image Rejection vs. RF Frequency at Various Temperatures

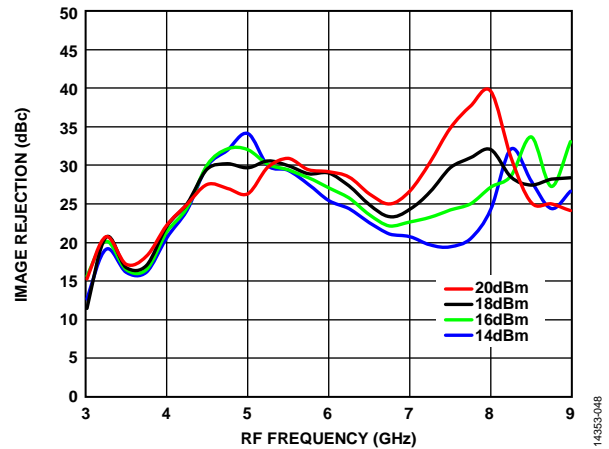

Figure 48. Image Rejection vs. RF Frequency at Various LO Drives

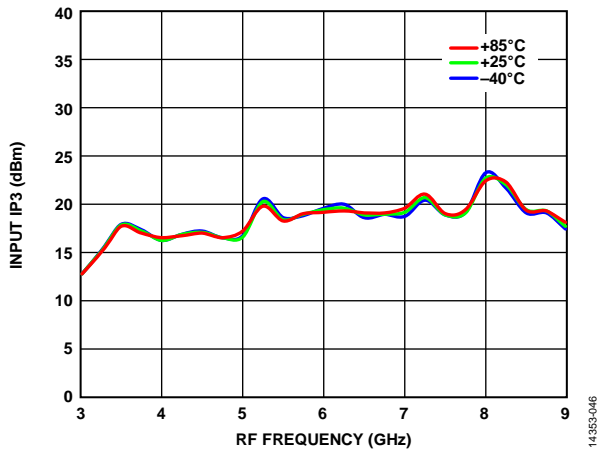

Figure 46. Input IP3 vs. RF Frequency at Various Temperatures

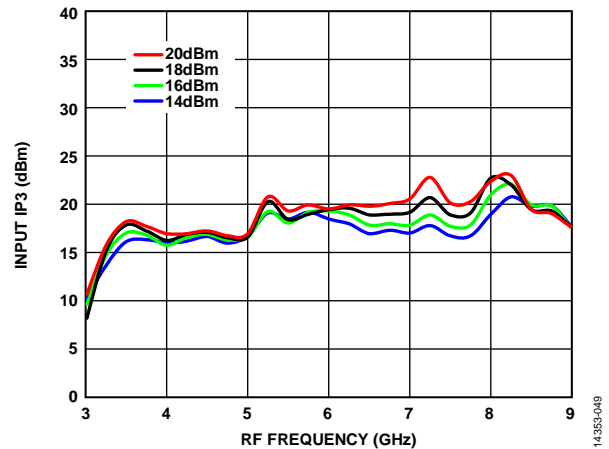

Figure 49. Input IP3 vs. RF Frequency at Various LO Drives

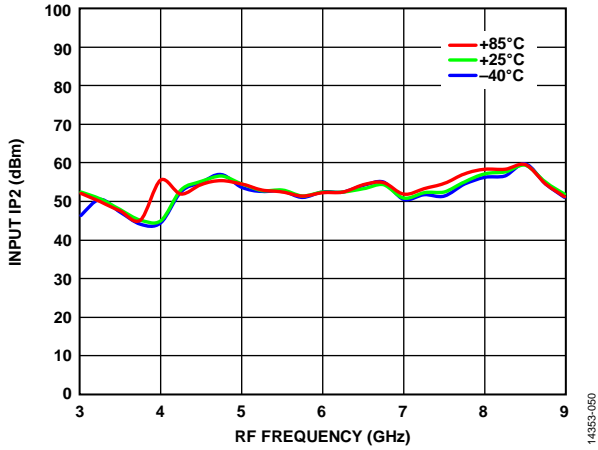

Figure 50. Input IP2 vs. RF Frequency at Various Temperatures

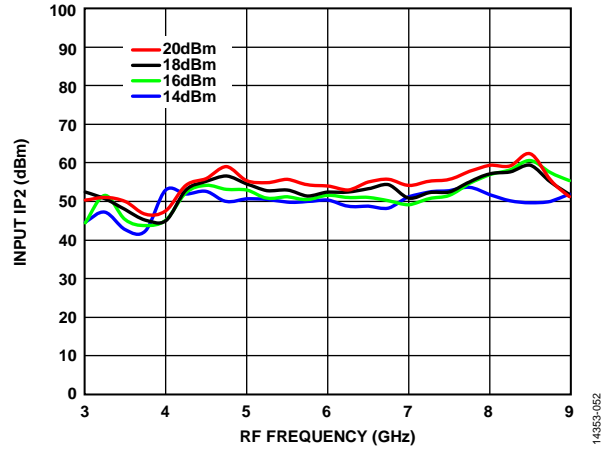

Figure 52. Input IP2 vs. RF Frequency at Various LO Drives

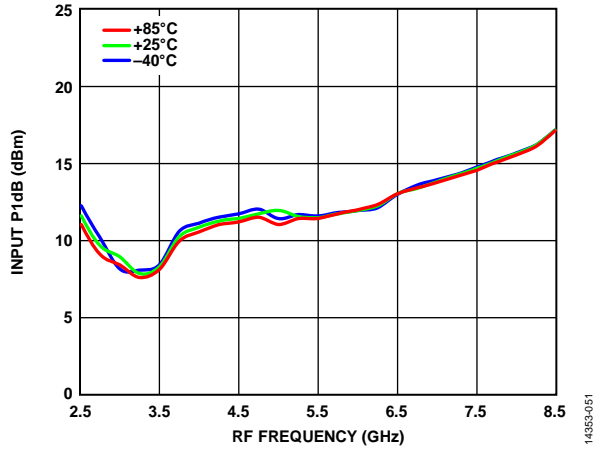

Figure 51. Input P1dB vs. RF Frequency at Various Temperatures

Downconverter Performance at IF = 3500 MHz, Upper Sideband

Data taken at LO drive = 18 dBm and T_A = 25°C, unless otherwise noted.

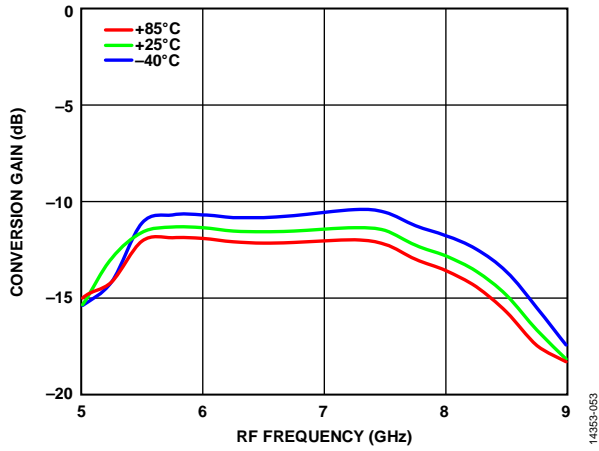

Figure 53. Conversion Gain vs. RF Frequency at Various Temperatures

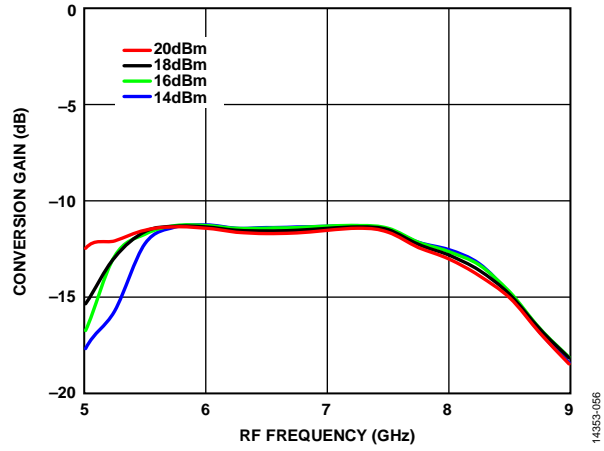

Figure 55. Conversion Gain vs. RF Frequency at Various LO Drives

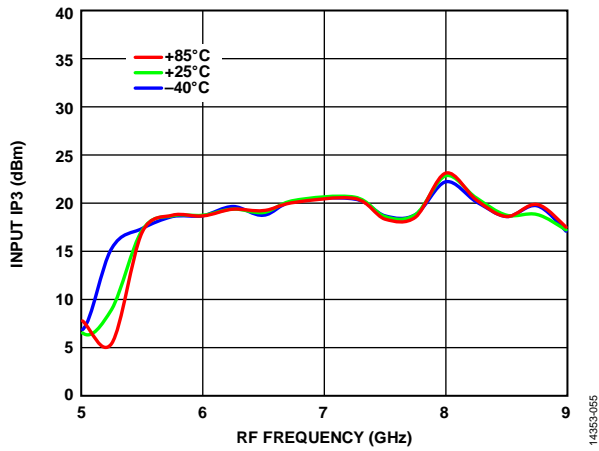

Figure 54. Input IP3 vs. RF Frequency at Various Temperatures

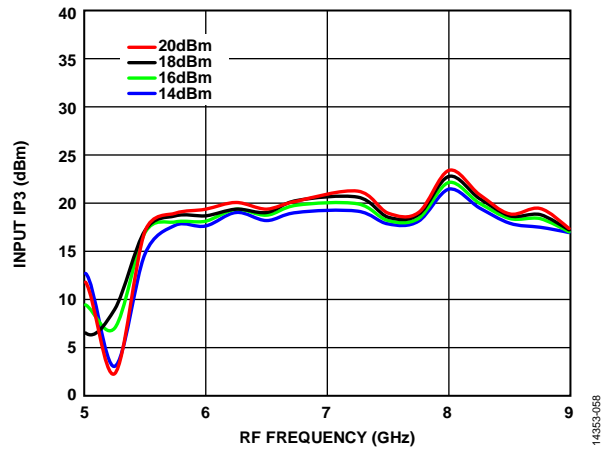

Figure 56. Input IP3 vs. RF Frequency at Various LO Drives

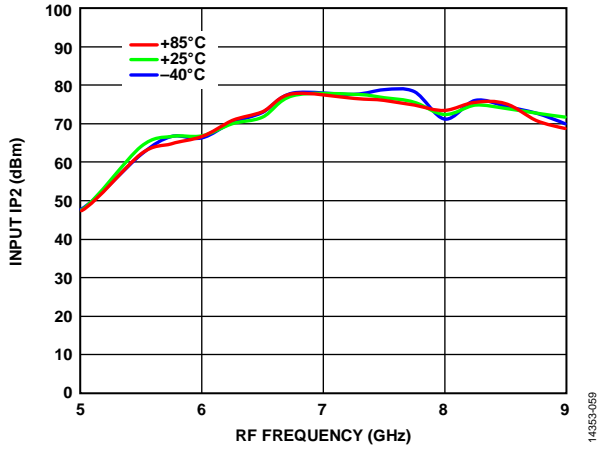

Figure 57. Input IP2 vs. RF Frequency at Various Temperatures

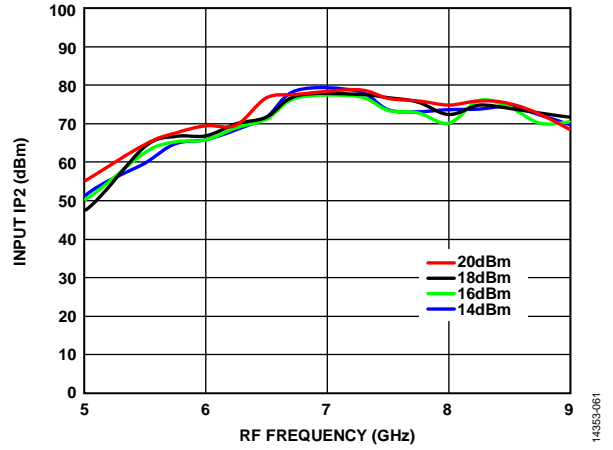

Figure 59. Input IP2 vs. RF Frequency at Various LO Drives

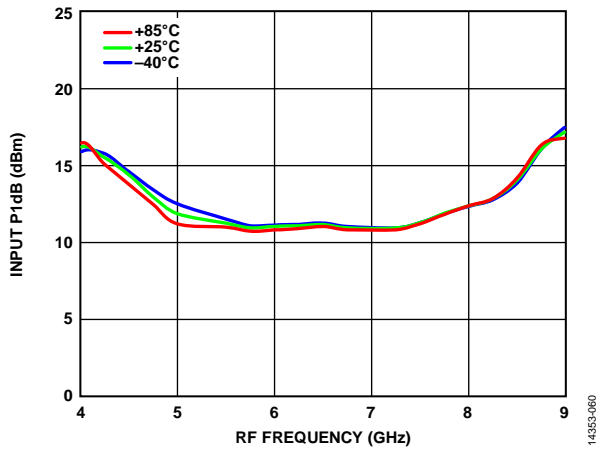

Figure 58. Input P1dB vs. RF Frequency at Various Temperatures

UPCONVERTER PERFORMANCE

Upconverter Performance at IF = 100 MHz, Lower Sideband

Data taken at LO drive = 18 dBm and T_A = 25°C, unless otherwise noted.

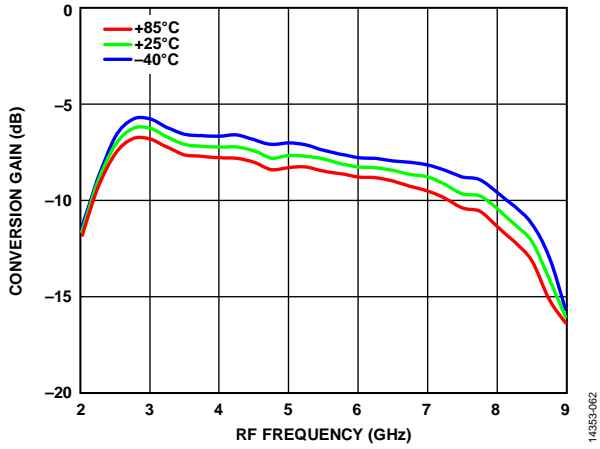

Figure 60. Conversion Gain vs. RF Frequency at Various Temperatures

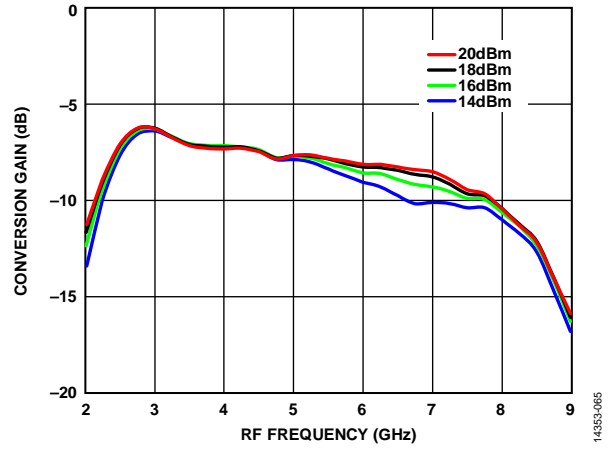

Figure 63. Conversion Gain vs. RF Frequency at Various LO Drives

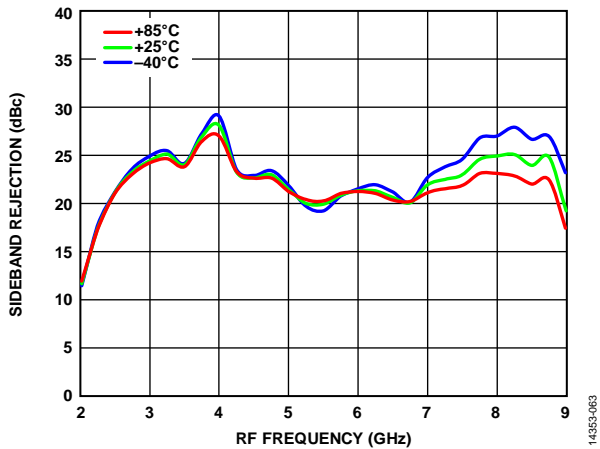

Figure 61. Sideband Rejection vs. RF Frequency at Various Temperatures

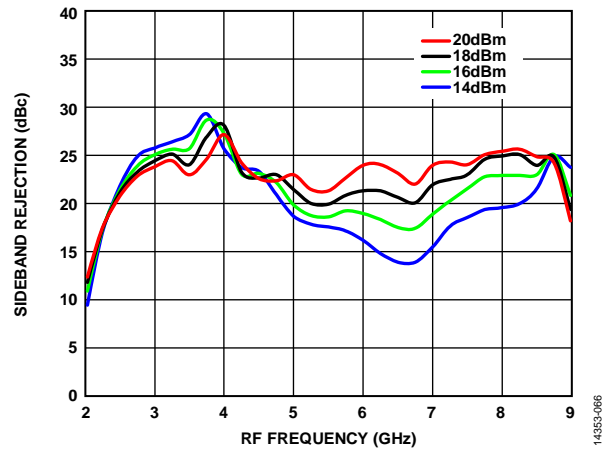

Figure 64. Sideband Rejection vs. RF Frequency at Various LO Drives

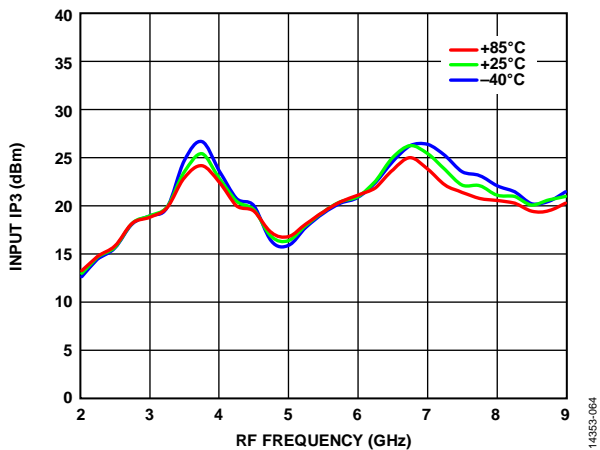

Figure 62. Input IP3 vs. RF Frequency at Various Temperatures

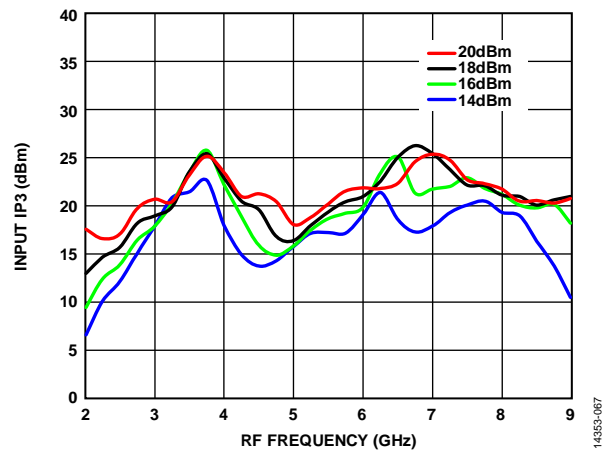

Figure 65. Input IP3 vs. RF Frequency at Various LO Drives

Upconverter Performance at IF = 1000 MHz, Lower Sideband

Data taken at LO drive = 18 dBm and $T_A = 25^\circ\text{C}$, unless otherwise noted.

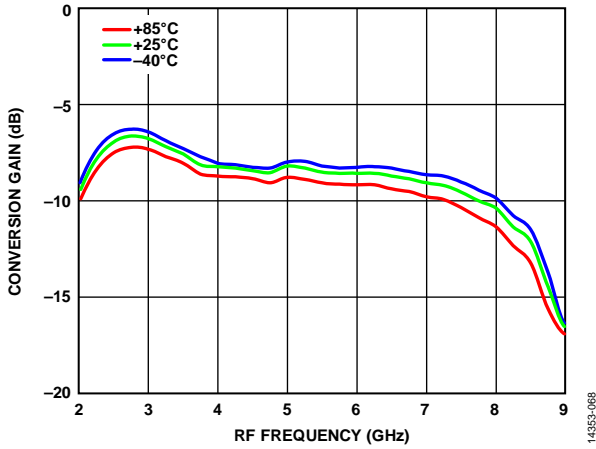

Figure 66. Conversion Gain vs. RF Frequency at Various Temperatures

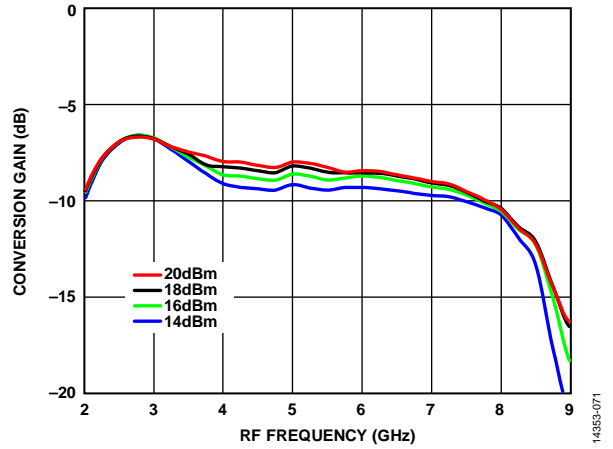

Figure 69. Conversion Gain vs. RF Frequency at Various LO Drives

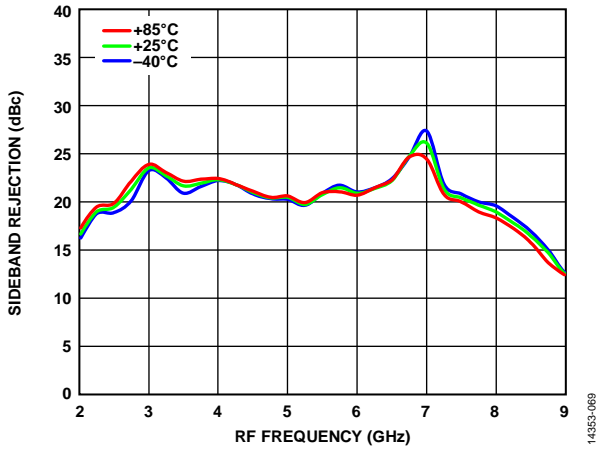

Figure 67. Sideband Rejection vs. RF Frequency at Various Temperatures

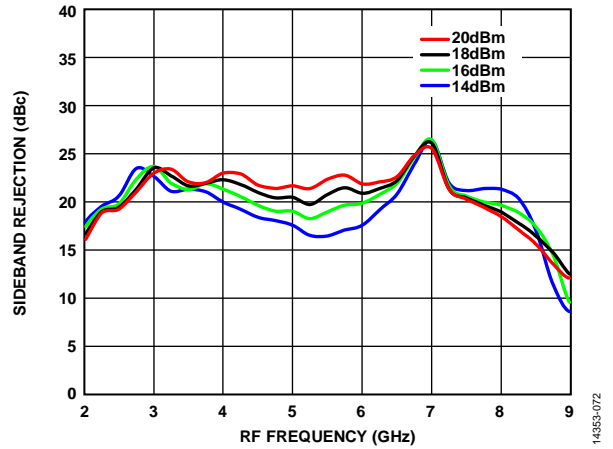

Figure 70. Sideband Rejection vs. RF Frequency at Various LO Drives

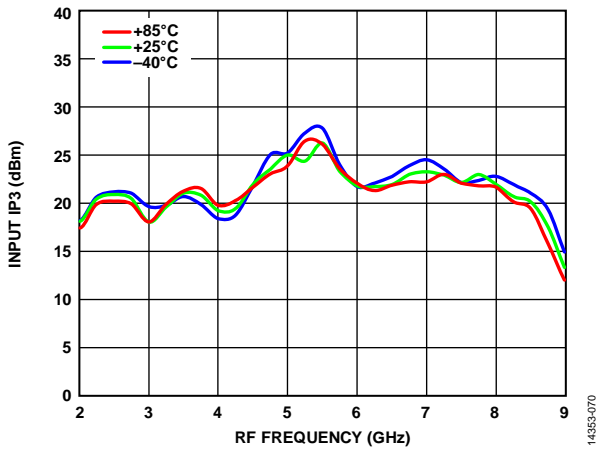

Figure 68. Input IP3 vs. RF Frequency at Various Temperatures

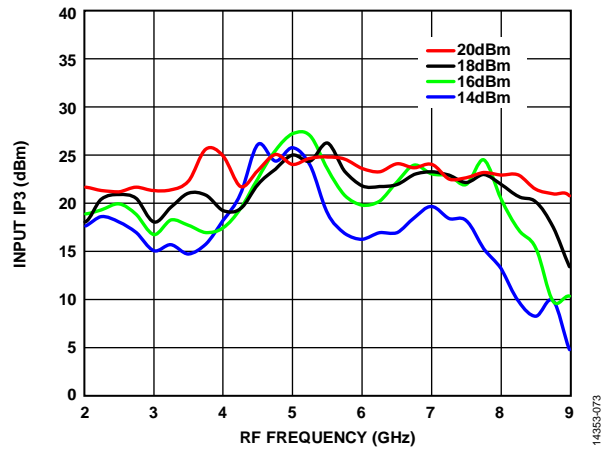

Figure 71. Input IP3 vs. RF Frequency at Various LO Drives

Upconverter Performance at IF = 3500 MHz, Lower Sideband

Data taken at LO drive = 18 dBm and T_A = 25°C, unless otherwise noted.

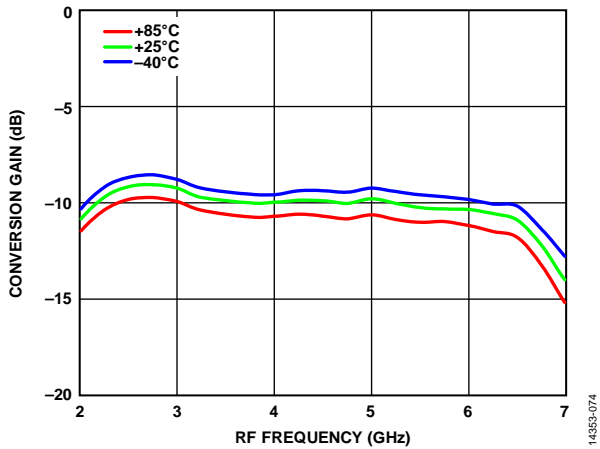

Figure 72. Conversion Gain vs. RF Frequency at Various Temperatures

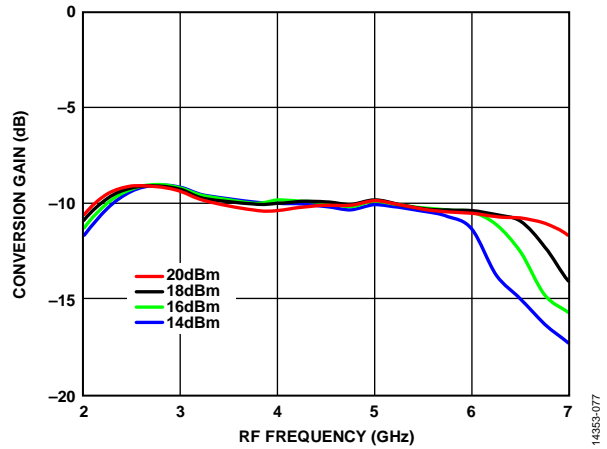

Figure 75. Conversion Gain vs. RF Frequency at Various LO Drives

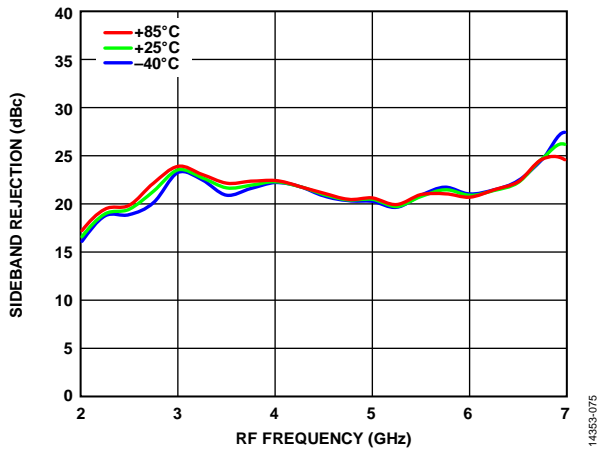

Figure 73. Sideband Rejection vs. RF Frequency at Various Temperatures

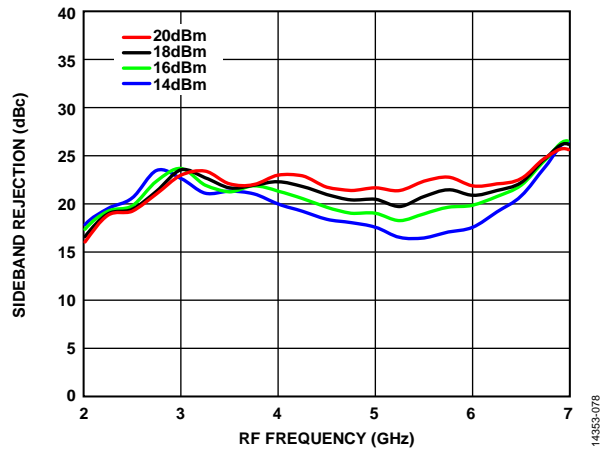

Figure 76. Sideband Rejection vs. RF Frequency at Various LO Drives

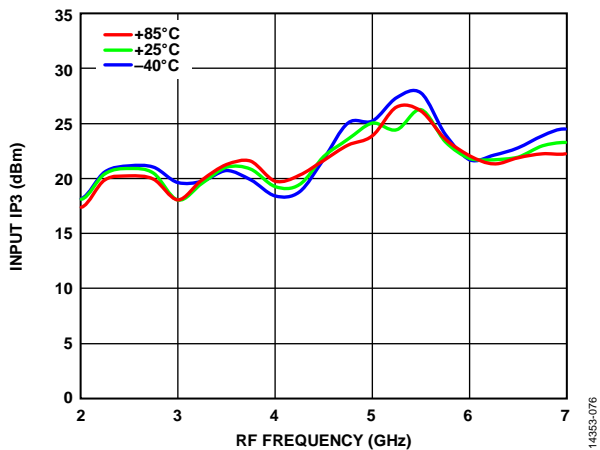

Figure 74. Input IP3 vs. RF Frequency at Various Temperatures

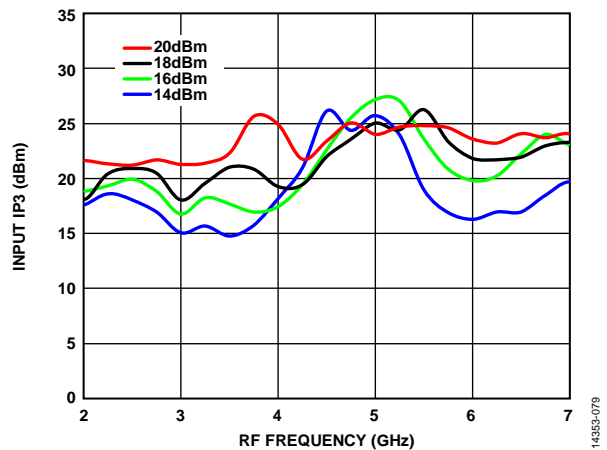

Figure 77. Input IP3 vs. RF Frequency at Various LO Drives

Upconverter Performance at IF = 100 MHz, Upper Sideband

Data taken at LO drive = 18 dBm and $T_A = 25^\circ\text{C}$, unless otherwise noted.

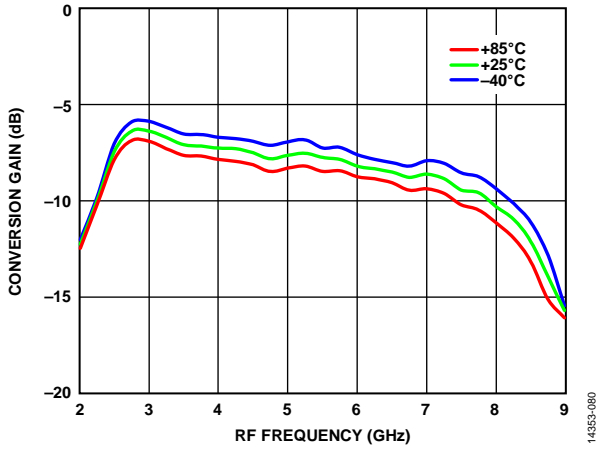

Figure 78. Conversion Gain vs. RF Frequency at Various Temperatures

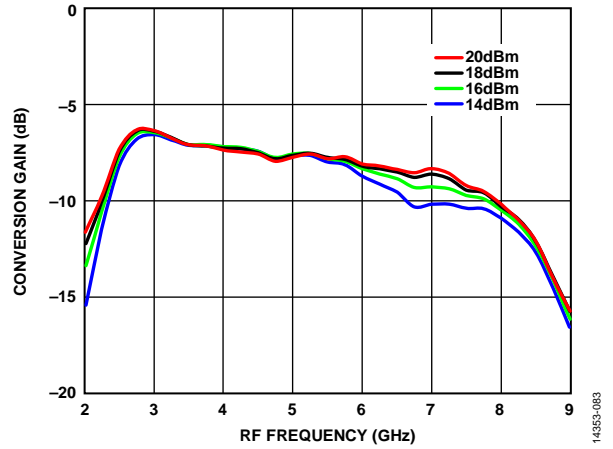

Figure 81. Conversion Gain vs. RF Frequency at Various LO Drives

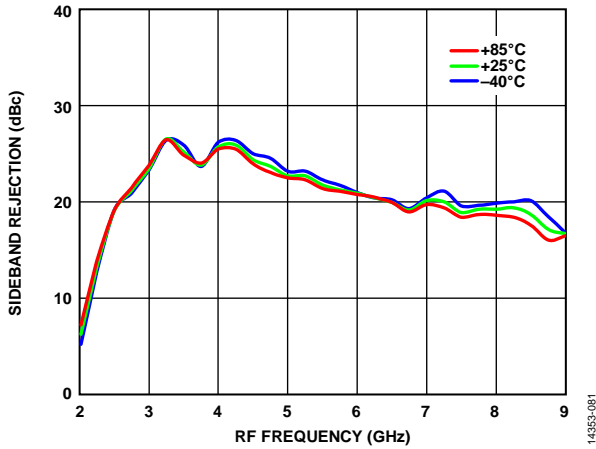

Figure 79. Sideband Rejection vs. RF Frequency at Various Temperatures

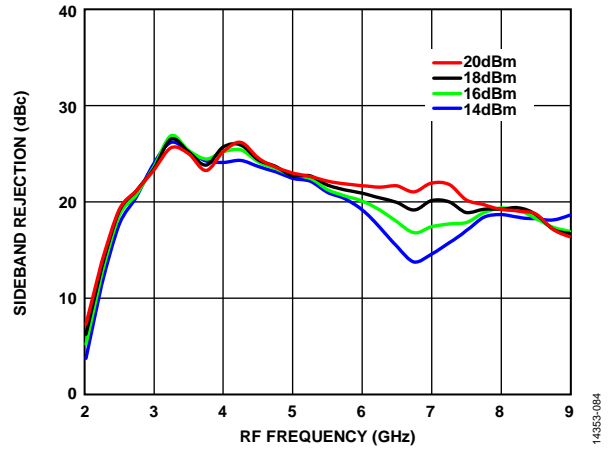

Figure 82. Sideband Rejection vs. RF Frequency at Various LO Drives

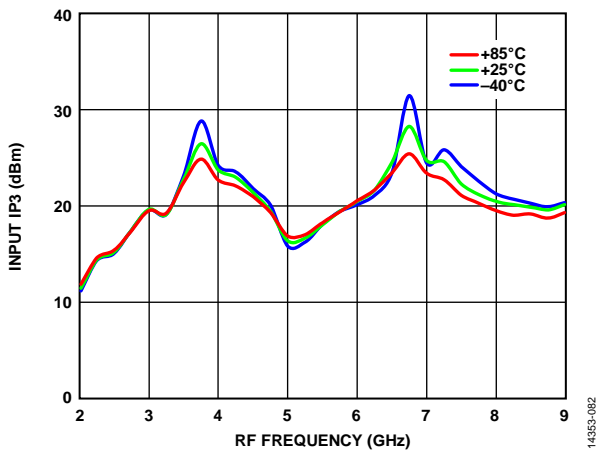

Figure 80. Input IP3 vs. RF Frequency at Various Temperatures

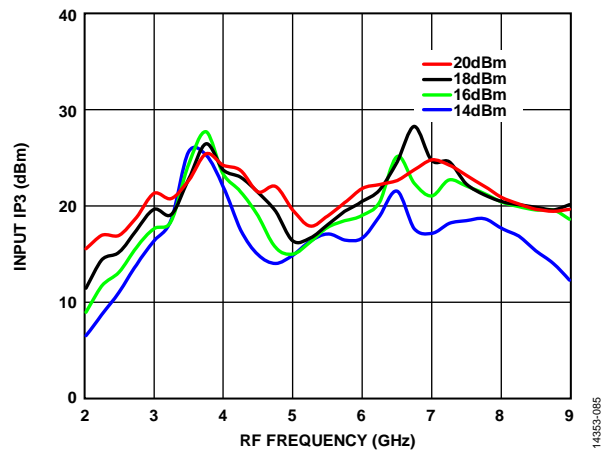

Figure 83. Input IP3 vs. RF Frequency at Various LO Drives

Upconverter Performance at IF = 1000 MHz, Upper Sideband

Data taken at LO drive = 18 dBm and T_A = 25°C, unless otherwise noted.

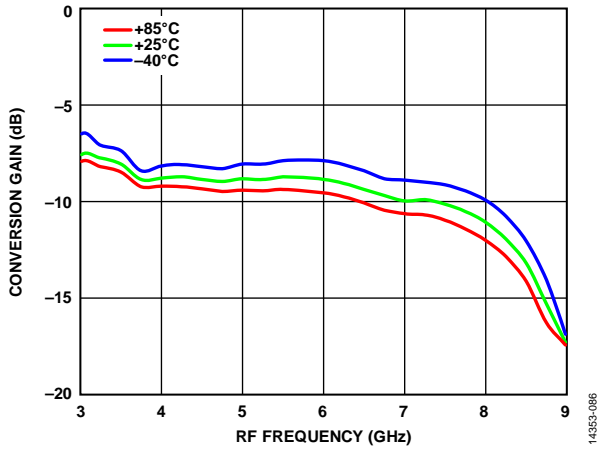

Figure 84. Conversion Gain vs. RF Frequency at Various Temperatures

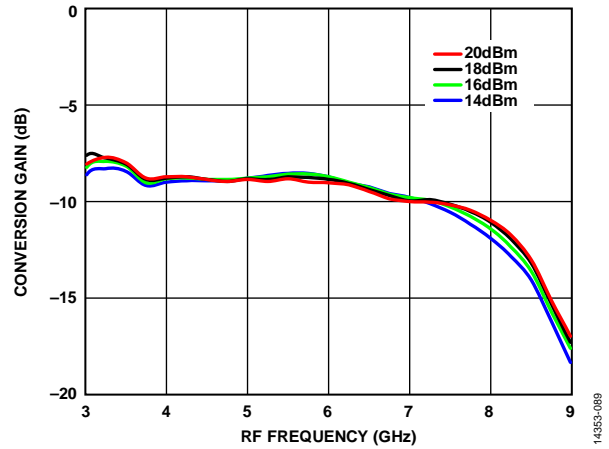

Figure 87. Conversion Gain vs. RF Frequency at Various LO Drives

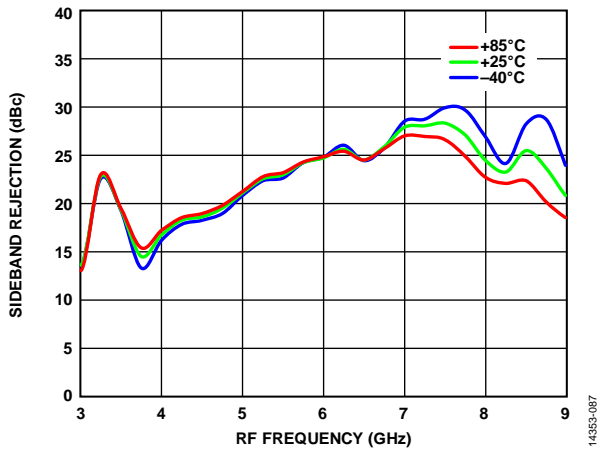

Figure 85. Sideband Rejection vs. RF Frequency at Various Temperatures

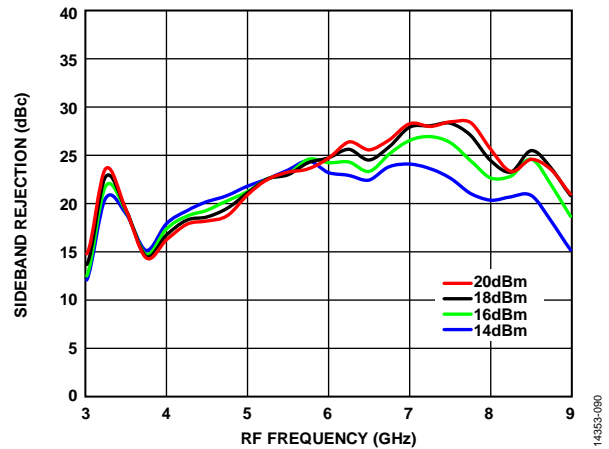

Figure 88. Sideband Rejection vs. RF Frequency at Various LO Drives

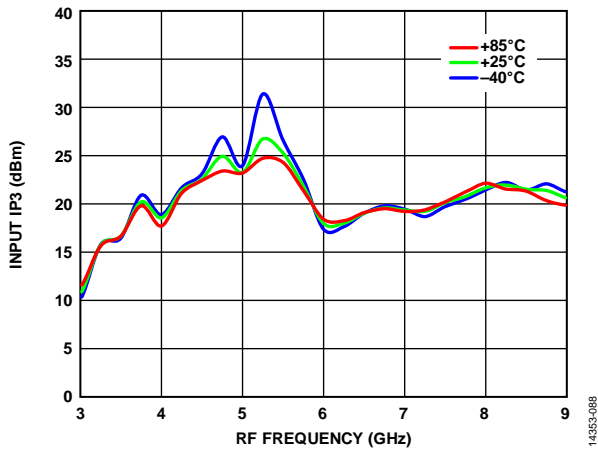

Figure 86. Input IP3 vs. RF Frequency at Various Temperatures

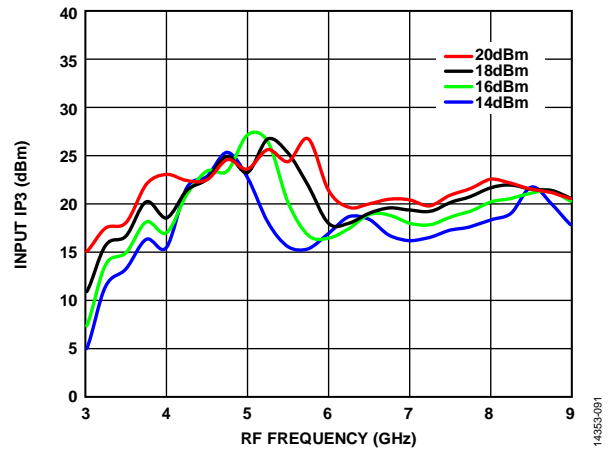

Figure 89. Input IP3 vs. RF Frequency at Various LO Drives

Upconverter Performance at IF = 3500 MHz, Upper Sideband

Data taken at LO drive = 18 dBm and $T_A = 25^\circ\text{C}$, unless otherwise noted.

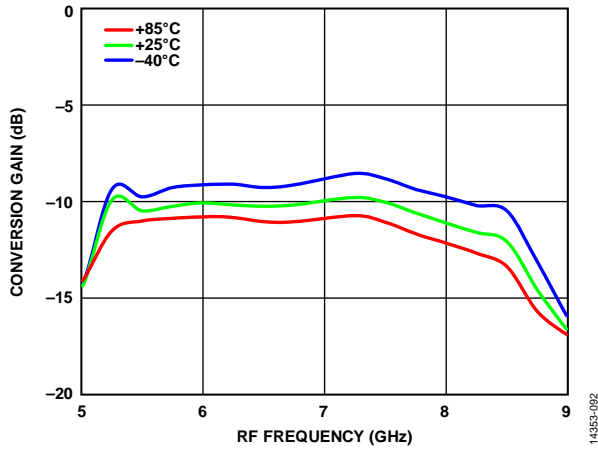

Figure 90. Conversion Gain vs. RF Frequency at Various Temperatures

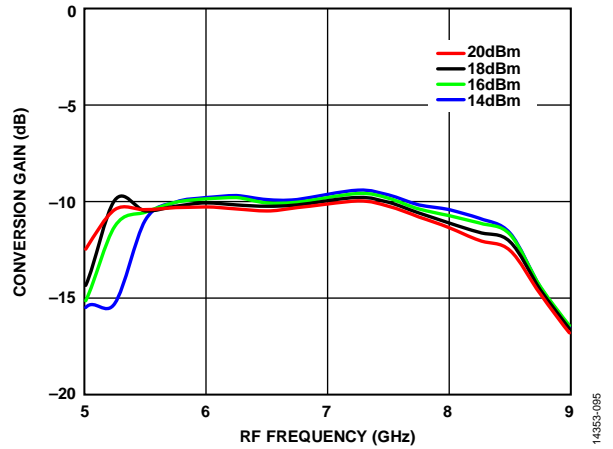

Figure 92. Conversion Gain vs. RF Frequency at Various LO Drives

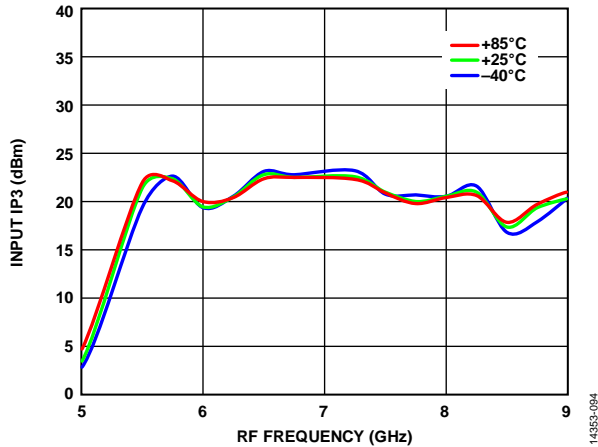

Figure 91. Input IP3 vs. RF Frequency at Various Temperatures

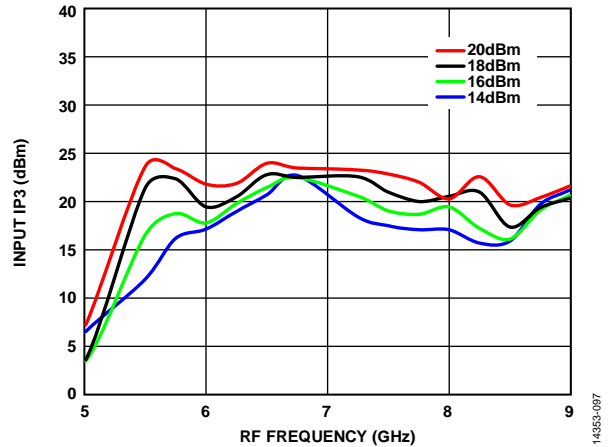

Figure 93. Input IP3 vs. RF Frequency at Various LO Drives

ISOLATION AND RETURN LOSS

Data taken at LO drive = 18 dBm, T_A = 25°C, unless otherwise noted.

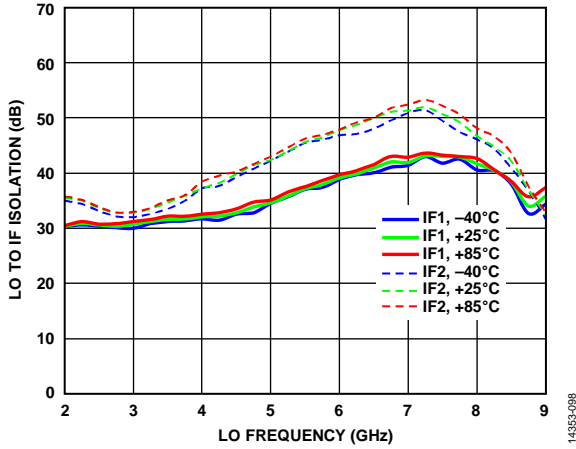

Figure 94. LO to IF Isolation vs. LO Frequency at Various Temperatures

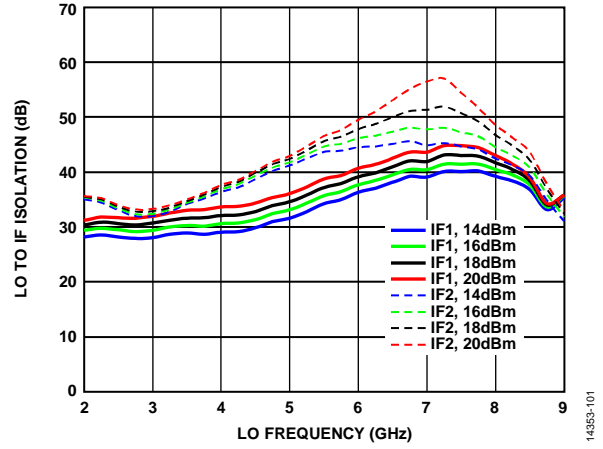

Figure 97. LO to IF Isolation vs. LO Frequency at Various LO Drives

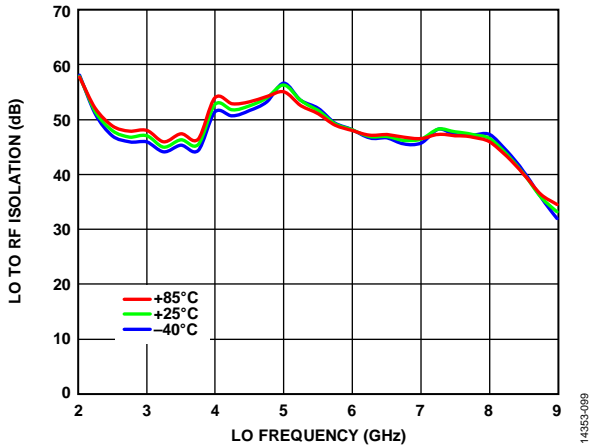

Figure 95. LO to RF Isolation vs. LO Frequency at Various Temperatures

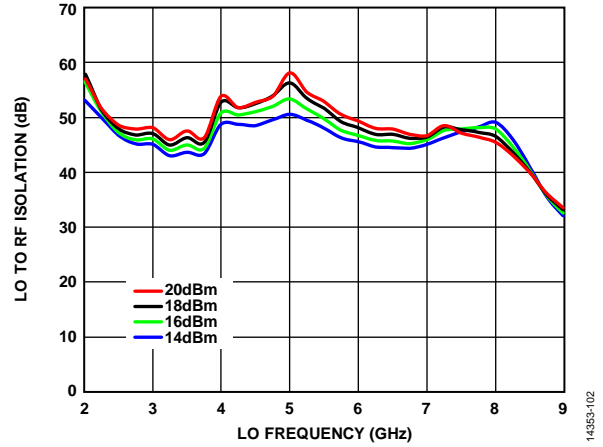

Figure 98. LO to RF Isolation vs. LO Frequency at Various LO Drives

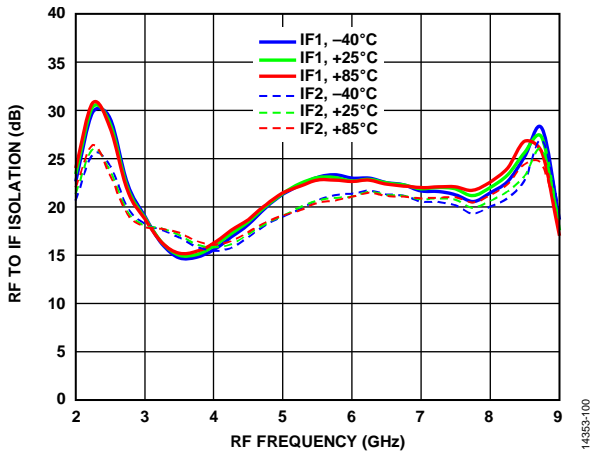

Figure 96. RF to IF Isolation vs. RF Frequency at Various Temperatures

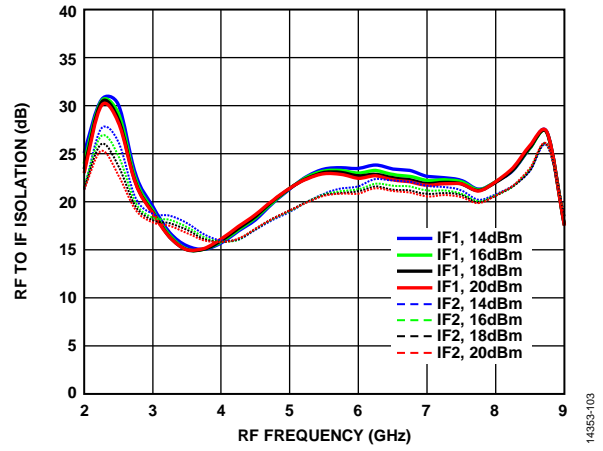

Figure 99. RF to IF Isolation vs. RF Frequency at Various LO Drives

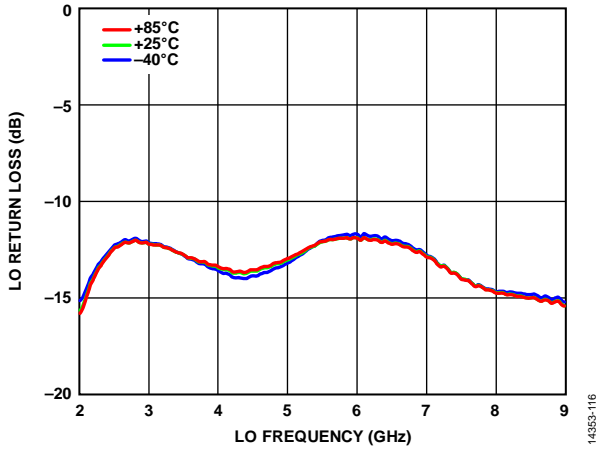

Figure 100. LO Return Loss vs. LO Frequency at Various Temperatures

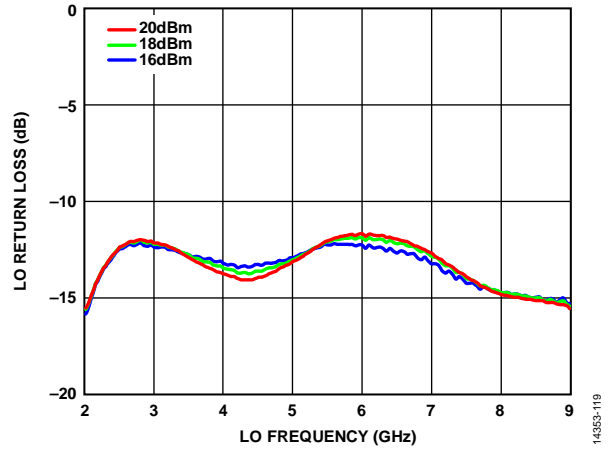

Figure 103. LO Return Loss vs. LO Frequency at Various LO Drives

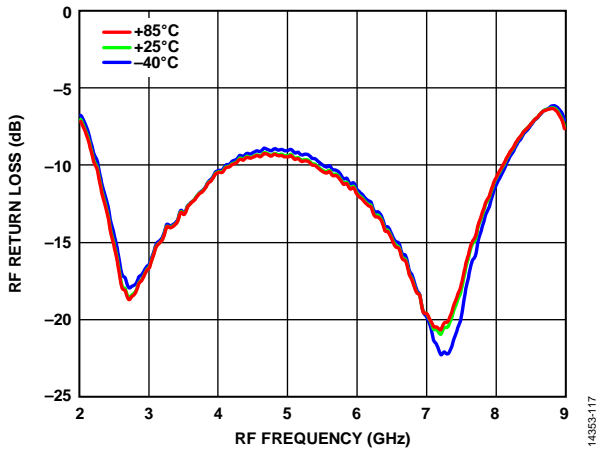

Figure 101. RF Return Loss vs. RF Frequency at Various Temperatures
LO Frequency = 5.5 GHz

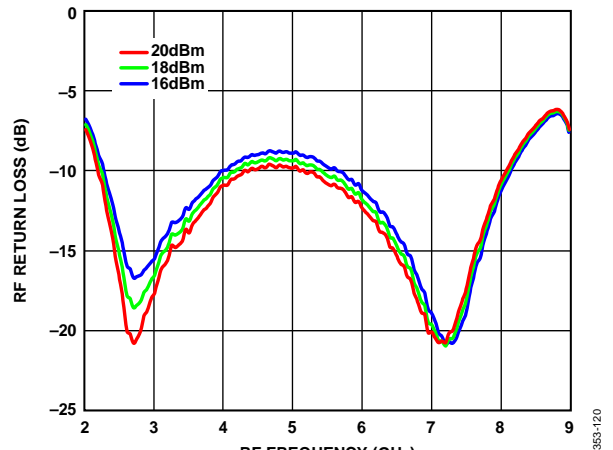

Figure 104. RF Return Loss vs. RF Frequency at Various LO Drives
LO Frequency = 5.5 GHz

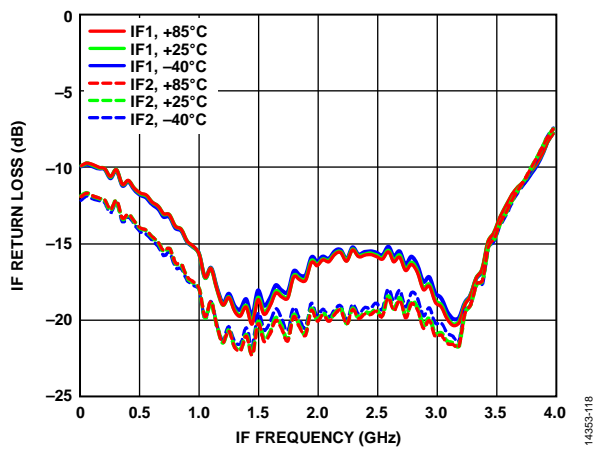

Figure 102. IF Return Loss vs. IF Frequency at Various Temperatures
LO Frequency = 5.5 GHz

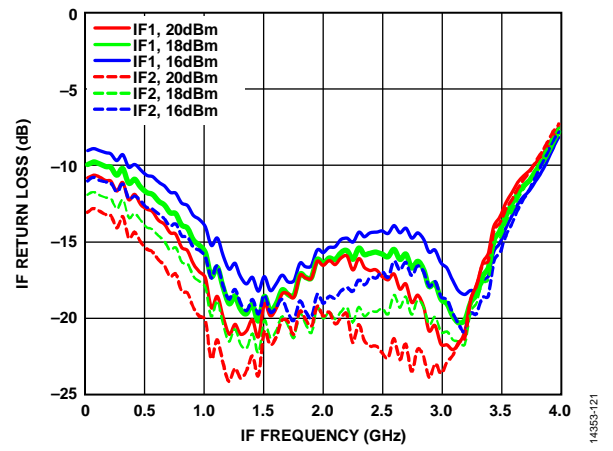

Figure 105. IF Return Loss vs. IF Frequency at Various LO Drives
LO Frequency = 5.5 GHz

IF BANDWIDTH

Data taken as a downconverter, lower sideband, at LO drive = 18 dBm, $T_A = 25^\circ\text{C}$, unless otherwise noted.

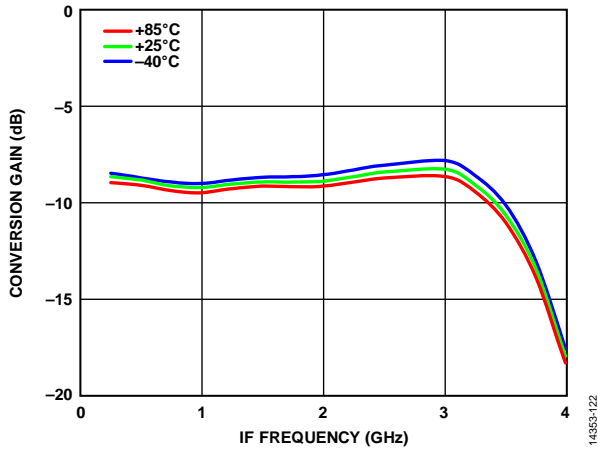

Figure 106. Conversion Gain vs. IF Frequency at Various Temperatures
LO Frequency = 5.5 GHz

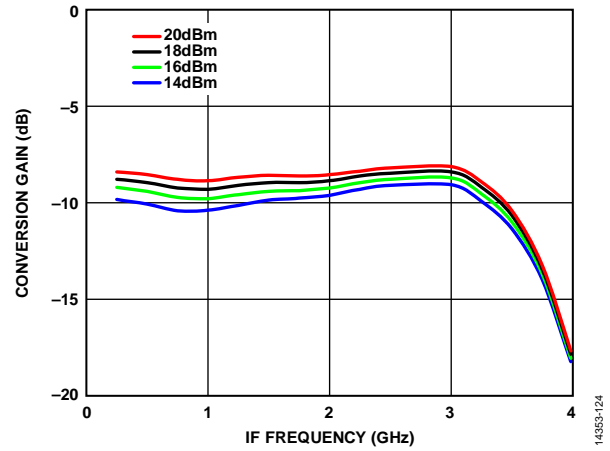

Figure 108. Conversion Gain vs. IF Frequency at Various LO Drives
LO Frequency = 5.5 GHz

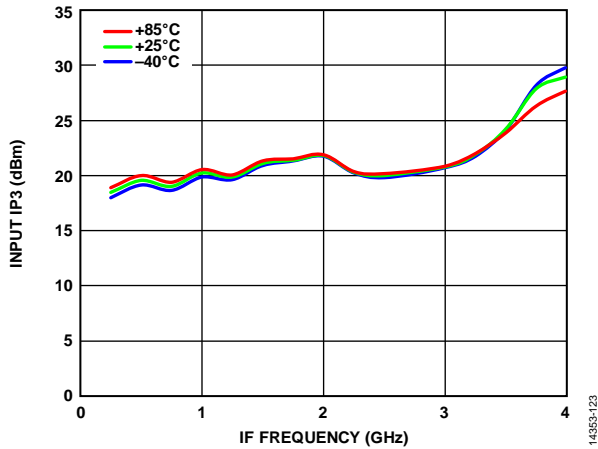

Figure 107. Input IP3 vs. IF Frequency at Various Temperatures
LO Frequency = 5.5 GHz

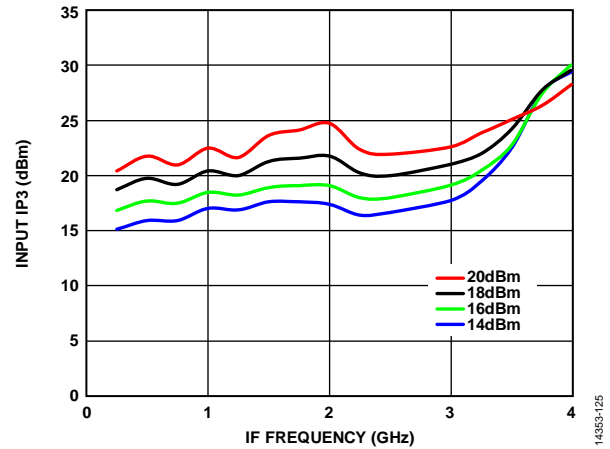

Figure 109. Input IP3 vs. IF Frequency at Various LO Drives
LO Frequency = 5.5 GHz

AMPLITUDE AND PHASE IMBALANCE

Downconverter Performance, Lower Sideband

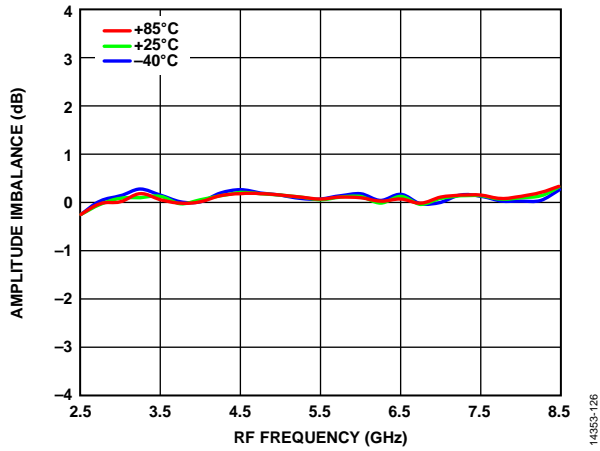

Figure 110. Amplitude Imbalance vs. RF Frequency at Various Temperatures, LO Drive = 18 dBm, IF = 100 MHz

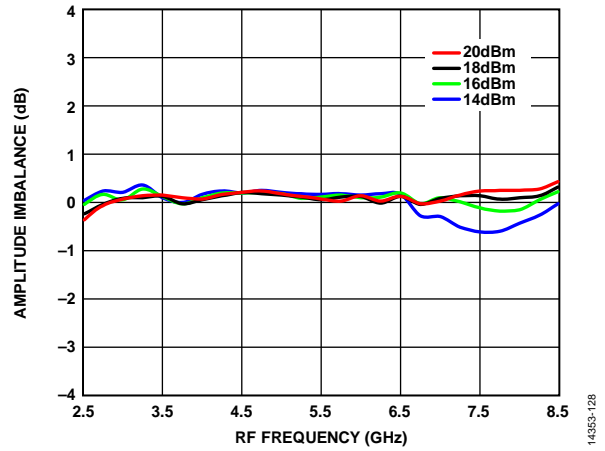

Figure 112. Amplitude Imbalance vs. RF Frequency at Various LO Drives, IF = 100 MHz, $T_A = 25^\circ\text{C}$

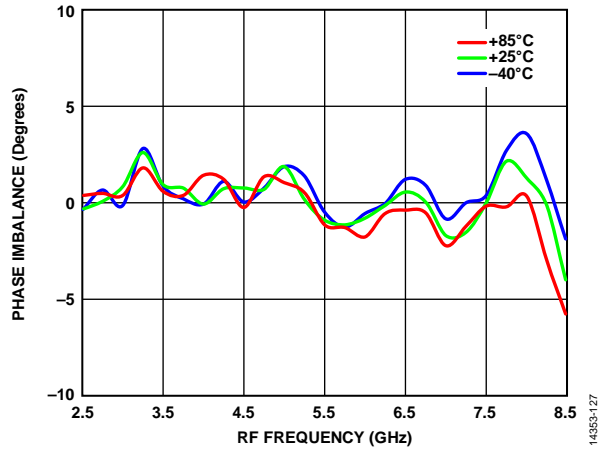

Figure 111. Phase Imbalance vs. RF Frequency at Various Temperatures, LO Drive = 18 dBm, IF = 100 MHz

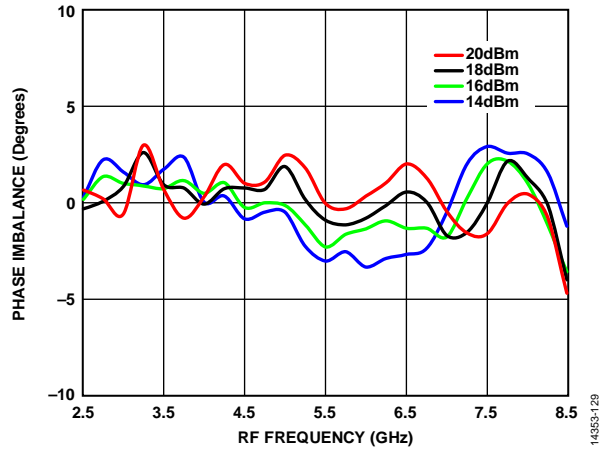

Figure 113. Phase Imbalance vs. RF Frequency at Various LO Drives, IF = 100 MHz, $T_A = 25^\circ\text{C}$

Downconverter Performance, Upper Sideband

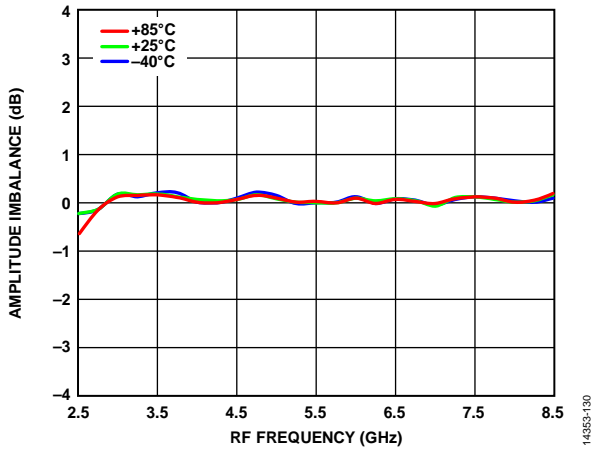

Figure 114. Amplitude Imbalance vs. RF Frequency at Various Temperatures, LO Drive = 18 dBm, IF = 100 MHz

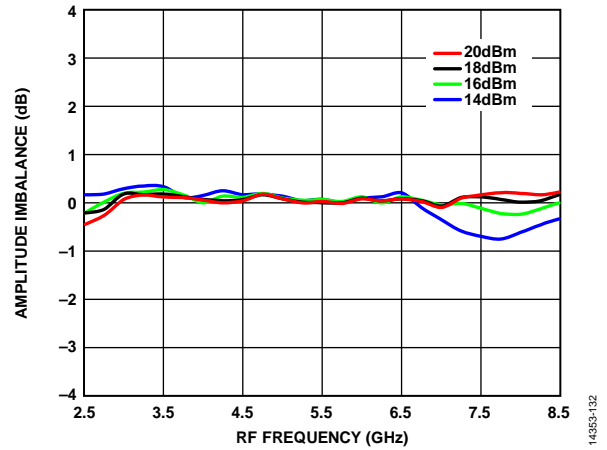

Figure 116. Amplitude Imbalance vs. RF Frequency at Various LO Drives, IF = 100 MHz, T_A = 25°C

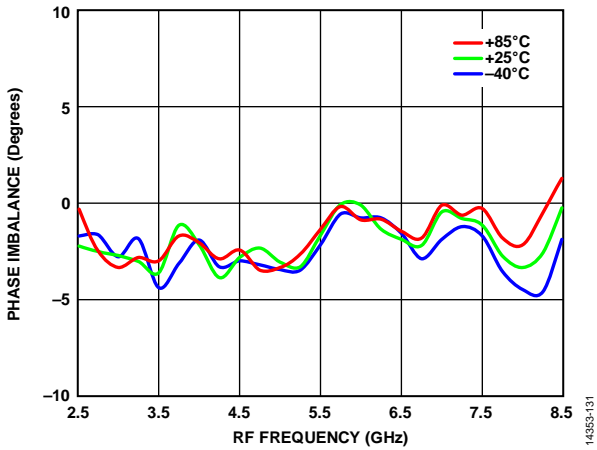

Figure 115. Phase Imbalance vs. RF Frequency at Various Temperatures, LO Drive = 18 dBm, IF = 100 MHz

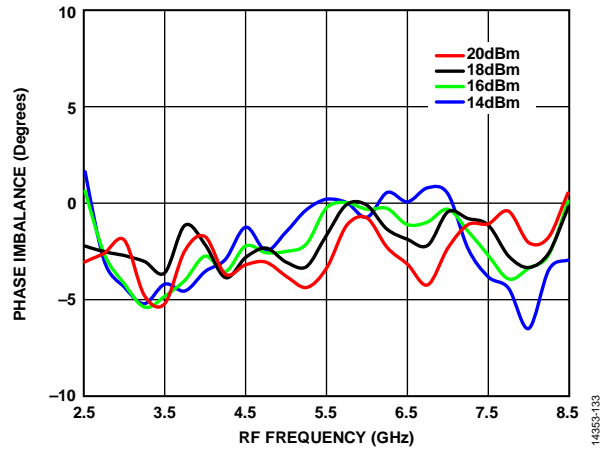

Figure 117. Phase Imbalance vs. RF Frequency at Various LO Drives, IF = 100 MHz, T_A = 25°C

SPURIOUS AND HARMONICS PERFORMANCE

All $M \times N$ spur data captured with the 90° hybrid attached.

Downconverter $M \times N$ Spurious Outputs

Mixer spurious products are measured in dBc from the IF output power level, unless otherwise specified. Spur values are $(M \times RF) - (N \times LO)$.

IF = 100 MHz, RF = 2500 MHz, LO = 2600 MHz, RF power = -10 dBm, and LO power = +18 dBm.

		N × LO				
		0	1	2	3	4
M × RF	0	Not applicable	0	34	33	47
	1	22	0	29	41	46
	2	84	69	73	70	85
	3	84	82	89	69	87
	4	82	83	79	89	92

IF = 100 MHz, RF = 5500 MHz, LO = 5600 MHz, RF power = -10 dBm, and LO power = +18 dBm.

		N × LO				
		0	1	2	3	4
M × RF	0	Not applicable	9	35	29	48
	1	23	0	53	47	52
	2	81	68	69	70	81
	3	80	82	84	67	80
	4	77	80	79	83	91

IF = 100 MHz, RF = 8500 MHz, LO = 8600 MHz, RF power = -10 dBm, and LO power = +18 dBm.

		N × LO				
		0	1	2	3	4
M × RF	0	Not applicable	1	30	35	48
	1	15	0	53	69	57
	2	76	76	72	78	76
	3	70	77	79	89	77
	4	67	72	76	80	87

IF = 1000 MHz, RF = 2500 MHz, LO = 3500 MHz, RF power = -10 dBm, and LO power = +18 dBm.

		N × LO				
		0	1	2	3	4
M × RF	0	Not applicable	-6	+22	+19	+33
	1	+11	+0	+32	+36	+43
	2	+74	+55	+77	+69	+72
	3	+73	+68	+65	+59	+76
	4	+71	+74	+59	+65	+68

IF = 1000 MHz, RF = 5500 MHz, LO = 6500 MHz, RF power = -10 dBm, and LO power = +18 dBm.

		N × LO				
		0	1	2	3	4
M × RF	0	Not applicable	2	19	13	35
	1	12	0	31	38	40
	2	71	61	65	64	70
	3	68	70	76	67	71
	4	64	68	69	77	73

IF = 1000 MHz, RF = 8500 MHz, LO = 9500 MHz, RF power = -10 dBm, and LO power = +18 dBm.

		N × LO				
		0	1	2	3	4
M × RF	0	Not applicable	-3	+19	+12	+32
	1	+6	+0	+35	+63	+51
	2	+66	+69	+62	+67	+63
	3	+59	+66	+70	+67	+66
	4	+59	+60	+66	+70	+68

IF = 3500 MHz, RF = 2500 MHz, LO = 6000 MHz, RF power = -10 dBm, and LO power = +18 dBm.

		N × LO				
		0	1	2	3	4
M × RF	0	Not applicable	4	36	13	52
	1	20	0	49	60	44
	2	74	61	80	87	81
	3	87	78	87	91	88
	4	92	94	97	92	88

IF = 3500 MHz, RF = 5500 MHz, LO = 9000 MHz, RF power = -10 dBm, and LO power = +18 dBm.

		N × LO				
		0	1	2	3	4
M × RF	0	Not applicable	7	23	28	41
	1	14	0	37	55	56
	2	85	91	88	81	83
	3	88	90	89	93	87
	4	87	88	93	93	85

IF = 3500 MHz, RF = 8500 MHz, LO = 12,000 MHz, RF power = -10 dBm, and LO power = +18 dBm.

		N × LO				
		0	1	2	3	4
M × RF	0	Not applicable	-20	+5	+7	+20
	1	-10	+0	+38	+61	+54
	2	+60	+69	+64	+64	+61
	3	+61	+61	+70	+64	+63
	4	+54	+63	+53	+34	+62

Upconverter M × N Spurious Outputs

Mixer spurious products are measured in dBc from the RF output power level, unless otherwise specified. Spur values are (M × IF) – (N × LO).

IF = 100 MHz, RF = 2500 MHz, LO = 2600 MHz, RF power = –10 dBm, and LO power = +18 dBm..

		N × LO				
		0	1	2	3	4
M × IF	0	Not applicable	10	9	24	20
	1	27	0	15	10	29
	2	75	53	47	61	61
	3	79	59	72	57	76
	4	93	90	92	89	92

IF = 100 MHz, RF = 5500 MHz, LO = 5600 MHz, RF power = –10 dBm, and LO power = +18 dBm.

		N × LO				
		0	1	2	3	4
M × IF	0	Not applicable	19	20	23	40
	1	25	0	50	26	44
	2	75	54	70	81	78
	3	89	69	85	84	85
	4	94	94	89	87	86

IF = 100 MHz, RF = 8500 MHz, LO = 8600 MHz, RF power = –10 dBm, and LO power = +18 dBm.

		N × LO				
		0	1	2	3	4
M × IF	0	Not applicable	–2	+16	+18	+19
	1	20	+0	+31	+35	+46
	2	67	+50	+55	+67	+75
	3	77	+70	+81	+79	+78
	4	92	+86	+81	+80	+74

IF = 1000 MHz, RF = 2500 MHz, LO = 3500 MHz, RF power = –10 dBm, and LO power = +18 dBm.

		N × LO				
		0	1	2	3	4
M × IF	0	Not applicable	12	11	23	34
	1	13	0	25	35	46
	2	57	48	63	70	80
	3	83	91	79	65	82
	4	77	91	84	67	83

IF = 1000 MHz, RF = 5500 MHz, LO = 6500 MHz, RF power = –10 dBm, and LO power = +18 dBm.

		N × LO				
		0	1	2	3	4
M × IF	0	Not applicable	13	25	33	41
	1	11	0	44	31	39
	2	63	40	69	64	75
	3	84	68	80	78	75
	4	84	89	82	79	76

IF = 1000 MHz, RF = 8500 MHz, LO = 9500 MHz, RF power = –10 dBm, and LO power = +18 dBm.

		N × LO				
		0	1	2	3	4
M × IF	0	Not applicable	–3	+24	+21	+34
	1	+8	0	+45	+36	+36
	2	+58	+37	+59	+63	+66
	3	+70	+70	+75	+69	+65
	4	+80	+80	+75	+70	+68

IF = 3500 MHz, RF = 2500 MHz, LO = 6000 MHz, RF power = –10 dBm, and LO power = +18 dBm.

		N × LO				
		0	1	2	3	4
M × IF	0	Not applicable	20	25	22	29
	1	8	0	33	43	41
	2	67	71	62	75	70
	3	87	79	80	79	88
	4	85	91	95	97	92

IF = 3500 MHz, RF = 5500 MHz, LO = 9000 MHz, RF power = –10 dBm, and LO power = +18 dBm.

		N × LO				
		0	1	2	3	4
M × IF	0	Not applicable	–5	+17	+42	+19
	1	+6	0	+40	+37	+49
	2	+62	+67	+67	+88	+73
	3	+91	+82	+80	+79	+84
	4	+86	+94	+94	+89	+88

IF = 3500 MHz, RF = 8500 MHz, LO = 12,000 MHz, RF power = –10 dBm, and LO power = +18 dBm.

		N × LO				
		0	1	2	3	4
M × IF	0	Not applicable	–1	+12	+5	+7
	1	–4	0	+29	+58	+59
	2	+37	+44	+62	+71	+60
	3	+53	+69	+72	+70	+58
	4	+70	+79	+74	+72	+65

LO Harmonics

LO drive = 18 dBm and all values in are in dBc below the input
LO level measured at the RF port.

Table 5. Harmonics of LO

LO Frequency (GHz)	N × LO Spur at RF Port			
	1	2	3	4
2.5	50	45	61	66
3.5	47	46	56	71
4.5	50	63	65	60
5.5	52	68	61	69
6.5	50	66	66	73
7.5	49	63	69	62
8.5	40	59	59	81

THEORY OF OPERATION

The HMC8193 is a passive, wideband, I/Q, MMIC mixer that can be used as an image rejection mixer or as a single-sideband upconverter for transmitter operations. With an RF and LO range of 2.5 GHz to 8.5 GHz, as well as an IF bandwidth of dc to 4 GHz, the HMC8193 is ideal for applications requiring wide frequency range, excellent RF performance, and a simple design that includes a few components and a small PCB footprint. A single HMC8193 can replace multiple narrow-band mixers in a design.

The inherent I/Q architecture of the HMC8193 offers excellent image rejection and sideband rejection, thereby eliminating the need for expensive filtering of unwanted sidebands. The double balanced architecture of the mixer also provides excellent LO to RF and LO to IF isolation and reduces the effect of LO leakage to ensure signal integrity.

The HMC8193 does not require any dc power sources because it is a passive mixer. The device offers a lower noise figure than an active mixer, ensuring superior dynamic range for high performance and precision applications.

The HMC8193 is fabricated on a GaAs MESFET process and uses Analog Devices mixer cells and a 90° hybrid. The HMC8193 is available in a compact, 4 mm × 4 mm, 24-terminal LCC package and operates over a -40°C to +85°C temperature range. An evaluation board for the HMC8193 is also available from Analog Devices.

For both upconversion and downconversion, an external 90° hybrid is required. See the Applications Information section for information regarding interfacing with an external 90° hybrid

APPLICATIONS INFORMATION

Figure 118 shows the typical application circuit for the HMC8193. To select the appropriate sideband, an external 90° hybrid is required. For applications not requiring operation to dc, use an off-chip dc blocking capacitor. For applications that require the LO signal at the output to be suppressed, use a bias tee/RF choke as shown in Figure 118. Ensure that the source/sink current used for LO suppression is less than 6 mA for each IF port; otherwise, device damage may occur. The common-mode voltage for each IF port is 0 V.

To select the upper sideband when using as an upconverter, connect the IF1 pin to the 90° port of the hybrid, and connect the IF2 pin to the 0° port of the hybrid. To select the lower sideband, connect IF1 to the 0° port of the hybrid and IF2 to the 90° port of the hybrid. The input is from the sum port of the hybrid and the difference port is 50 Ω terminated.

To select the upper sideband (low-side LO) when using as a downconverter, connect the IF1 pin to the 0° port of the hybrid, and connect the IF2 pin to the 90° port of the hybrid. To select the lower sideband (high-side LO), connect the IF1 pin to the 90° port of the hybrid and IF2 to the 0° port of the hybrid. The output is from the sum port of the hybrid, and the difference port is 50 Ω terminated.

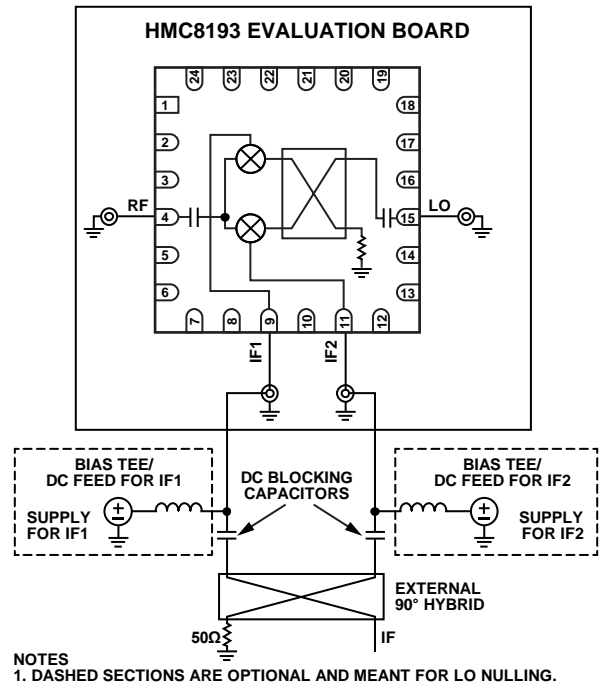

Figure 118. Typical Application Circuit

SOLDERING INFORMATION AND RECOMMENDED LAND PATTERN

Figure 119 and Figure 120 show the recommended land pattern and solder stencil for the HMC8193, respectively. The HMC8193 is contained in a 4 mm × 4 mm, 24-terminal, ceramic, LCC package, which has an exposed ground pad (EP). This pad is internally connected to the ground of the chip. To minimize

thermal impedance and ensure electrical performance, solder the pad to the low impedance ground plane on the PCB. To further reduce thermal impedance, it is recommended that the ground planes on all layers under the pad be stitched together with vias.

The land pattern on the HMC8193 evaluation board provides a simulated thermal resistance (θ_{JA}) of 120°C/W

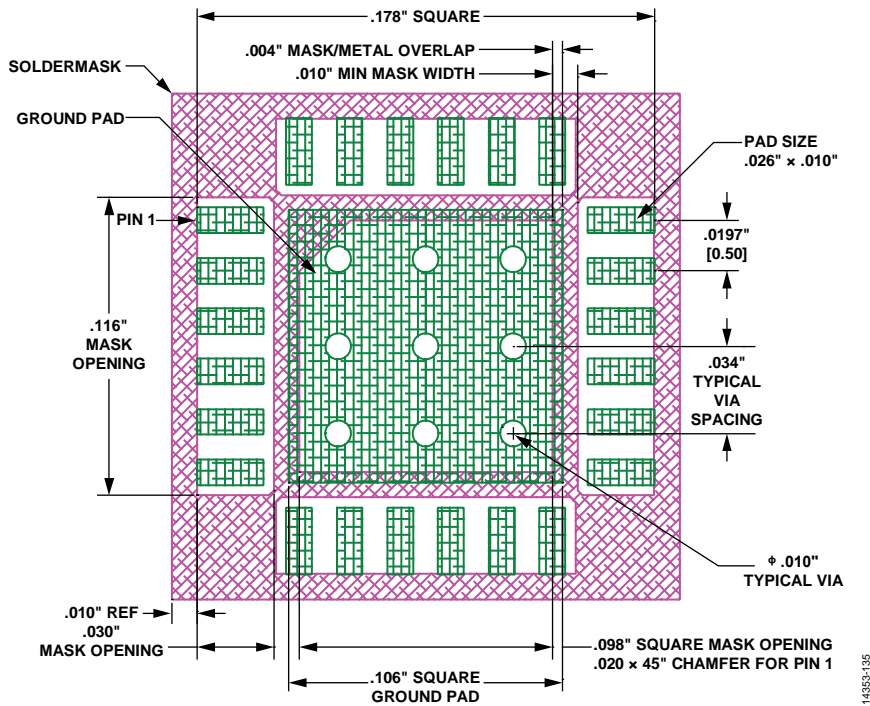

Figure 119. Evaluation Board Land Pattern for the HMC8193 Package

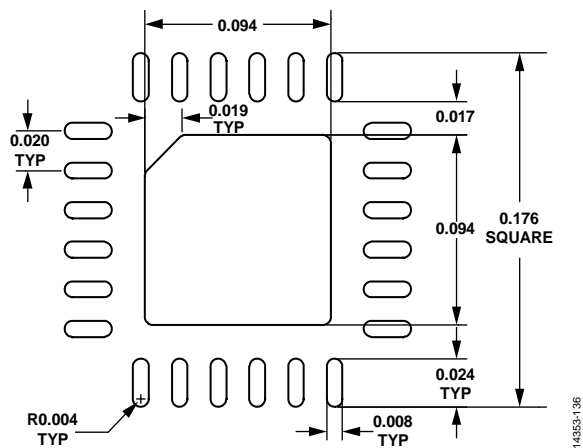

Figure 120. Solder Stencil for the HMC8193 Package on the HMC8193 Evaluation Board

EVALUATION BOARD INFORMATION

The [EV1HMC8193LC4](#) evaluation PCB used in the application must use RF circuit design techniques. Signal lines must have 50 Ω impedance and connect the package ground leads and exposed pad directly to the ground plane, similar to what is

shown in Figure 119. Use a sufficient number of via holes to connect the top and bottom ground planes. The evaluation circuit board shown in Figure 121 is available from Analog Devices upon request.

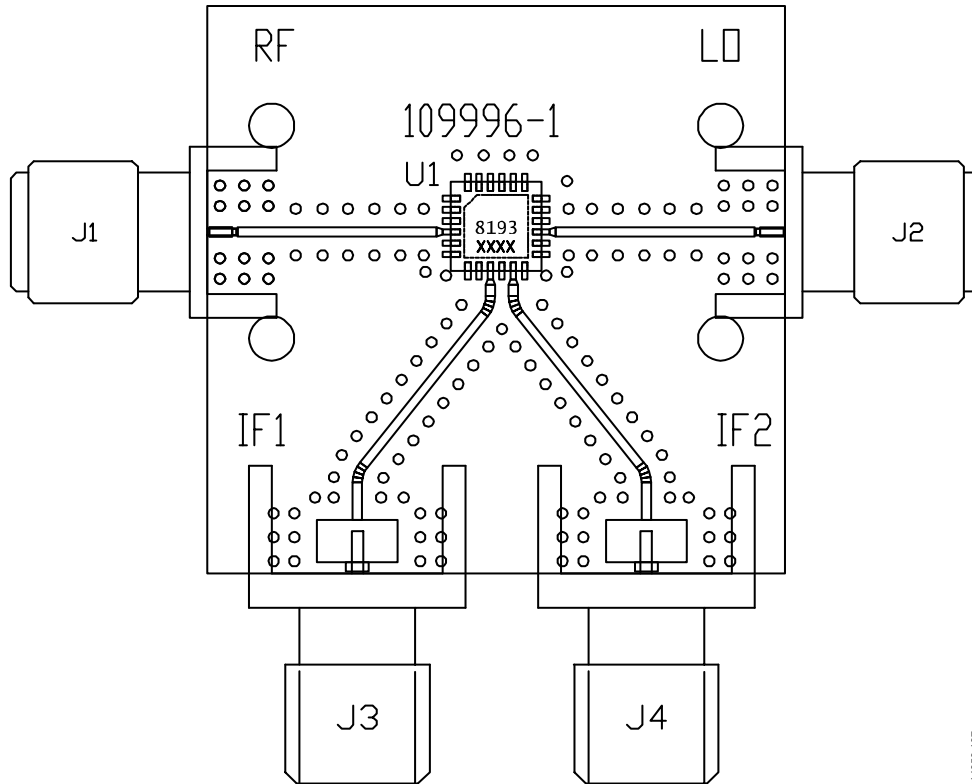

Figure 121. EV1HMC8193LC4 Evaluation PCB, Top Layer

14353-137

Table 6. Bill of Materials for the [EV1HMC8193LC4](#)¹ Evaluation PCB

Quantity	Reference Designator	Description	Manufacturer	Part Number
1	Not applicable	PCB, EV1HMC8193LC4 ²	Analog Devices	109996-1
2	J1, J2	PCB mount SMA RF connector	SRI Connector Gage Co.	21-146-1000-01
2	J3, J4	PCB mount SMA connector	Johnson SMA Connector	142-0701-851
1	U1	Device under test (HMC8193)	Analog Devices	HMC8193

¹ Reference this number when ordering the evaluation PCB.

² The circuit board material is Rogers 4350.

OUTLINE DIMENSIONS

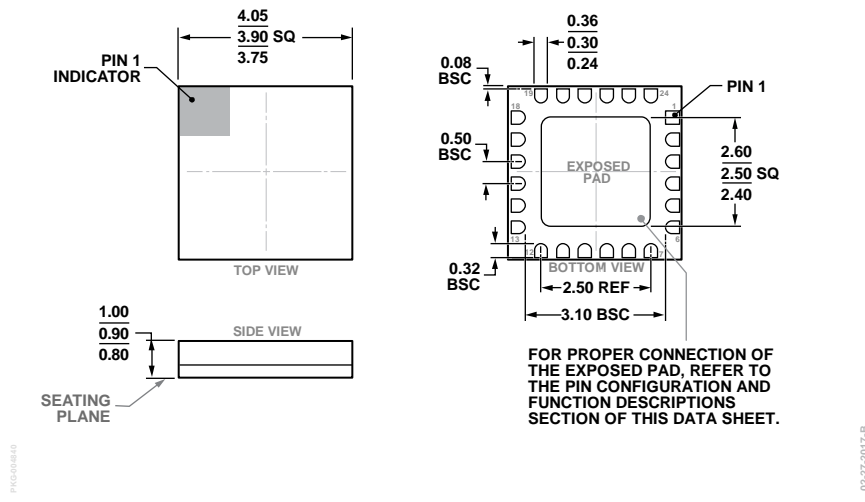

Figure 122. 24-Terminal Ceramic Leadless Chip Carrier [LCC] (E-24-1)
Dimensions shown in millimeters

ORDERING GUIDE

Model ¹	Temperature Range	Package Body Material	Lead Finish	Package Description	MSL Rating ²	Package Option
HMC8193LC4	-40°C to +85°C	Alumina Ceramic	Gold over Nickel	24-Terminal LCC	MSL3	E-24-1
HMC8193LC4TR	-40°C to +85°C	Alumina Ceramic	Gold over Nickel	24-Terminal LCC	MSL3	E-24-1
HMC8193LC4TR-R5	-40°C to +85°C	Alumina Ceramic	Gold over Nickel	24-Terminal LCC	MSL3	E-24-1
EV1HMC8193LC4				Evaluation PCB Assembly		

¹ The HMC8193LC4, the HMC8193LC4TR, and the HMC8193LC4TR-R5 are RoHS compliant parts.

² See the Absolute Maximum Ratings section.

Mouser Electronics

Authorized Distributor

Click to View Pricing, Inventory, Delivery & Lifecycle Information:

[Analog Devices Inc.:](#)

[EV1HMC8193LC4](#)