

FEATURES

- 3 dB bandwidth of 3.3 GHz ($A_v = 6$ dB)
- Pin-strappable gain adjust: 6 dB, 12 dB, 15.5 dB
- Differential or single-ended input to differential output
- Low noise input stage: 2.1 nV/ $\sqrt{\text{Hz}}$ RTI at $A_v = 12$ dB
- Low broadband distortion ($A_v = 6$ dB)
 - 10 MHz: –91 dBc HD2, –98 dBc HD3
 - 70 MHz: –102 dBc HD2, –90 dBc HD3
 - 140 MHz: –104 dBc HD2, –87 dBc HD3
 - 250 MHz: –80 dBc HD2, –94 dBc HD3
- IMD3s of –94 dBc at 250 MHz center
- Slew rate: 9.8 V/ns
- Fast settling of 2 ns and overdrive recovery of 3 ns
- Single-supply operation: 3 V to 3.6 V
- Power-down control
- Fabricated using the high speed XFCB3 SiGe process

APPLICATIONS

- Differential ADC drivers
- Single-ended to differential conversion
- RF/IF gain blocks
- SAW filter interfacing

GENERAL DESCRIPTION

The **ADL5562** is a high performance differential amplifier optimized for RF and IF applications. The amplifier offers low noise of 2.1 nV/ $\sqrt{\text{Hz}}$ and excellent distortion performance over a wide frequency range, making it an ideal driver for high speed 8-bit to 16-bit ADCs.

The **ADL5562** provides three gain levels of 6 dB, 12 dB, and 15.5 dB through a pin-strappable configuration. For the single-ended input configuration, the gains are reduced to 5.6 dB, 11.1 dB, and 14.1 dB. Using an external series input resistor expands the amplifier gain flexibility and allows for any gain selection from 0 dB to 15.5 dB.

The quiescent current of the **ADL5562** is typically 80 mA and, when disabled, consumes less than 3 mA, offering excellent input-to-output isolation.

FUNCTIONAL BLOCK DIAGRAM

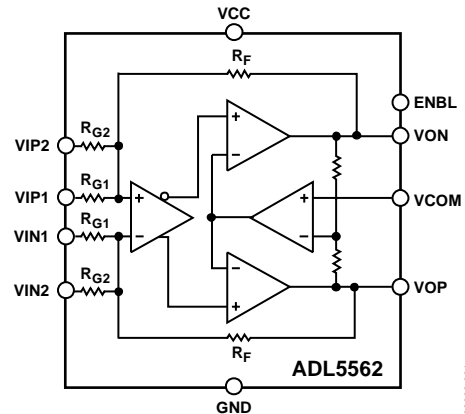

Figure 1.

The device is optimized for wideband, low distortion performance. These attributes, together with its adjustable gain capability, make this device the amplifier of choice for general-purpose IF and broadband applications where low distortion, noise, and power are critical. This device is optimized for the best combination of slew speed, bandwidth, and broadband distortion. These attributes allow it to drive a wide variety of analog-to-digital converters (ADCs) and make it ideally suited for driving mixers, pin diode attenuators, SAW filters, and multi-element discrete devices.

Fabricated on an Analog Devices, Inc., high speed SiGe process, the **ADL5562** is supplied in a compact 3 mm × 3 mm, 16-lead LFCSP package and operates over the temperature range of –40°C to + 85°C.

TABLE OF CONTENTS

| | | | |
|--|----|--------------------------------------|----|
| Features | 1 | Basic Structure..... | 13 |
| Applications..... | 1 | Applications Information..... | 14 |
| Functional Block Diagram | 1 | Basic Connections..... | 14 |
| General Description..... | 1 | Input and Output Interfacing..... | 15 |
| Revision History | 2 | Gain Adjustment and Interfacing..... | 16 |
| Specifications..... | 3 | ADC Interfacing..... | 16 |
| Absolute Maximum Ratings..... | 6 | Layout Considerations..... | 18 |
| ESD Caution..... | 6 | Soldering Information | 19 |
| Pin Configuration and Function Descriptions..... | 7 | Evaluation Board..... | 19 |
| Typical Performance Characteristics | 8 | Outline Dimensions..... | 21 |
| Circuit Description..... | 13 | Ordering Guide | 21 |

REVISION HISTORY

9/2017—Rev. E to Rev. F

| | |
|----------------------------------|----|
| Updated Outline Dimensions | 21 |
| Changes to Ordering Guide..... | 21 |

1/2014—Rev. D to Rev. E

| | |
|--|---|
| Changes to ENBL Threshold Parameter, Table 1 | 3 |
|--|---|

4/2013—Rev. C to Rev. D

| | |
|---------------------------------------|---|
| Changes to Table 1..... | 3 |
| Changes to Figure 6 and Figure 7..... | 8 |

7/2011—Rev. B to Rev. C

| | |
|--|----|
| Changes to Figure 28 and Figure 29..... | 12 |
| Added Figure 30 and Figure 31; Renumbered Sequentially | 12 |
| Changes to Ordering Guide | 21 |

3/2010—Rev. A to Rev. B

| | |
|---------------------------------|----|
| Changes to Figure 43..... | 19 |
| Updated Outline Dimensions..... | 21 |
| Changes to Ordering Guide..... | 21 |

9/2009—Rev. 0 to Rev. A

| | |
|--|----|
| Changes to Features Section | 1 |
| Changes to Table 1..... | 3 |
| Changes to Figure 5..... | 8 |
| Changes to Figure 9 and Figure 10..... | 9 |
| Changes to Figure 32, Equation 1, and Figure 34 | 15 |
| Changes to Equation 2..... | 16 |
| Changes to Figure 38, Figure 39, Figure 40, and Table 9..... | 17 |
| Changes to Figure 43..... | 19 |
| Moved Table 14 to | 19 |

5/2009—Revision 0: Initial Version

SPECIFICATIONS

VCC = 3.3 V, VCOM = 1.65 V, RL = 200 Ω differential, AV = 6 dB, CL = 1 pF differential, f = 140 MHz, TA = 25°C.

Table 1.

| Parameter | Conditions | Min | Typ | Max | Unit |
|--|---|------|------------|------|--------|
| DYNAMIC PERFORMANCE | | | | | |
| -3 dB Bandwidth | AV = 6 dB, VOUT ≤ 1.0 V p-p | | 3300 | | MHz |
| | AV = 12 dB, VOUT ≤ 1.0 V p-p | | 3900 | | MHz |
| | AV = 15.5 dB, VOUT ≤ 1.0 V p-p | | 1900 | | MHz |
| Bandwidth for 0.1 dB Flatness | AV = 6 dB, VOUT ≤ 1.0 V p-p | | 220 | | MHz |
| | AV = 12 dB, VOUT ≤ 1.0 V p-p | | 270 | | MHz |
| | AV = 15.5 dB, VOUT ≤ 1.0 V p-p | | 270 | | MHz |
| Gain Accuracy | AV = 6 dB, RL = open | | 0.17 | | dB |
| | AV = 12 dB, RL = open | | 0.05 | | dB |
| | AV = 15.5 dB, RL = open | | 0.06 | | dB |
| Gain Supply Sensitivity | VCC ± 5% | | -0.005 | | dB/V |
| Gain Temperature Sensitivity | -40°C to +85°C, AV = 15.5 dB | | 0.32 | | mdB/°C |
| Slew Rate | Rise, AV = 15.5 dB, RL = 200 Ω, VOUT = 2 V step | | 9.8 | | V/ns |
| | Fall, AV = 15.5 dB, RL = 200 Ω, VOUT = 2 V step | | 10.1 | | V/ns |
| Settling Time | 2 V step to 1% | | 2 | | ns |
| Overdrive Recovery Time | VIN = 4 V to 0 V step, VOUT ≤ ±10 mV | | 3 | | ns |
| Reverse Isolation (S12) | | | 60 | | dB |
| INPUT/OUTPUT CHARACTERISTICS | | | | | |
| Output Common Mode | | | VCC/2 | | V |
| Voltage Adjustment Range | | | 1.4 to 1.8 | | V |
| Maximum Output Voltage Swing | 1 dB compressed | | 4.9 | | V p-p |
| Output Common-Mode Offset | Referenced to VCC/2 | | 60 | | mV |
| Output Common-Mode Drift | -40°C to +85°C | | 285 | | μV/°C |
| Output Differential Offset Voltage | | | 1 | | mV |
| CMRR | | | 65 | | dB |
| Output Differential Offset Drift | -40°C to +85°C | | 15 | | μV/°C |
| Input Bias Current | | | 3 | | μA |
| Input Resistance (Differential) | AV = 6 dB | | 400 | | Ω |
| | AV = 12 dB | | 200 | | Ω |
| | AV = 15.5 dB | | 133 | | Ω |
| | AV = 5.6 dB, RS = 50 Ω | | 307 | | Ω |
| Input Resistance (Single-Ended) ¹ | AV = 11.1 dB, RS = 50 Ω | | 179 | | Ω |
| | AV = 14.1 dB, RS = 50 Ω | | 132 | | Ω |
| | | | 0.3 | | pF |
| Input Capacitance (Single-Ended) | | | 0.3 | | pF |
| Output Resistance (Differential) | | | 12 | | Ω |
| POWER INTERFACE | | | | | |
| Supply Voltage | | 3 | 3.3 | 3.6 | V |
| ENBL Threshold | Device disabled, ENBL low | | | 0.5 | V |
| | Device enabled, ENBL high | 1.5 | | | V |
| ENBL Input Bias Current | ENBL high | | -27 | | μA |
| | ENBL low | | -300 | | μA |
| Quiescent Current | ENBL high | 75.5 | 80 | 84.5 | mA |
| | ENBL low | | 3.5 | | mA |

| Parameter | Conditions | Min | Typ | Max | Unit |
|---|---|-----|----------|-----|------------------------|
| 10 MHz NOISE/HARMONIC PERFORMANCE | | | | | |
| Second/Third Harmonic Distortion | $A_V = 6 \text{ dB}, R_L = 200 \Omega, V_{OUT} = 2 \text{ V p-p}$ | | -91/-98 | | dBc |
| | $A_V = 12 \text{ dB}, R_L = 200 \Omega, V_{OUT} = 2 \text{ V p-p}$ | | -95/-98 | | dBc |
| | $A_V = 15.5 \text{ dB}, R_L = 200 \Omega, V_{OUT} = 2 \text{ V p-p}$ | | -96/-92 | | dBc |
| Output Third-Order Intercept/Third-Order Intermodulation Distortion | $A_V = 6 \text{ dB}, R_L = 200 \Omega, V_{OUT} = 2 \text{ V p-p composite}$ (2 MHz spacing) | | +42/-97 | | dBm/dBc |
| | $A_V = 12 \text{ dB}, R_L = 200 \Omega, V_{OUT} = 2 \text{ V p-p composite}$ (2 MHz spacing) | | +43/-93 | | dBm/dBc |
| | $A_V = 15.5 \text{ dB}, R_L = 200 \Omega, V_{OUT} = 2 \text{ V p-p composite}$ (2 MHz spacing) | | +43/-91 | | dBm/dBc |
| Noise Spectral Density (RTI) | $A_V = 6 \text{ dB}$ | | 3 | | nV/ $\sqrt{\text{Hz}}$ |
| | $A_V = 12 \text{ dB}$ | | 2.1 | | nV/ $\sqrt{\text{Hz}}$ |
| | $A_V = 15.5 \text{ dB}$ | | 1.6 | | nV/ $\sqrt{\text{Hz}}$ |
| 1 dB Compression Point (RTO) | $A_V = 6 \text{ dB}$ | | 13.5 | | dBm |
| | $A_V = 12 \text{ dB}$ | | 13.4 | | dBm |
| | $A_V = 15.5 \text{ dB}$ | | 13 | | dBm |
| 70 MHz NOISE/HARMONIC PERFORMANCE | | | | | |
| Second/Third Harmonic Distortion | $A_V = 6 \text{ dB}, R_L = 200 \Omega, V_{OUT} = 2 \text{ V p-p}$ | | -102/-90 | | dBc |
| | $A_V = 12 \text{ dB}, R_L = 200 \Omega, V_{OUT} = 2 \text{ V p-p}$ | | -97/-85 | | dBc |
| | $A_V = 15.5 \text{ dB}, R_L = 200 \Omega, V_{OUT} = 2 \text{ V p-p}$ | | -93/-83 | | dBc |
| Output Third-Order Intercept/Third-Order Intermodulation Distortion | $A_V = 6 \text{ dB}, R_L = 200 \Omega, V_{OUT} = 2 \text{ V p-p composite}$ (2 MHz spacing) | | +46/-96 | | dBm/dBc |
| | $A_V = 12 \text{ dB}, R_L = 200 \Omega, V_{OUT} = 2 \text{ V p-p composite}$ (2 MHz spacing) | | +44/-93 | | dBm/dBc |
| | $A_V = 15.5 \text{ dB}, R_L = 200 \Omega, V_{OUT} = 2 \text{ V p-p composite}$ (2 MHz spacing) | | +43/-91 | | dBm/dBc |
| Noise Spectral Density (RTI) | $A_V = 6 \text{ dB}$ | | 3 | | nV/ $\sqrt{\text{Hz}}$ |
| | $A_V = 12 \text{ dB}$ | | 2.1 | | nV/ $\sqrt{\text{Hz}}$ |
| | $A_V = 15.5 \text{ dB}$ | | 1.6 | | nV/ $\sqrt{\text{Hz}}$ |
| 1 dB Compression Point (RTO) | $A_V = 6 \text{ dB}$ | | 13.2 | | dBm |
| | $A_V = 12 \text{ dB}$ | | 13.2 | | dBm |
| | $A_V = 15.5 \text{ dB}$ | | 12.6 | | dBm |
| 140 MHz NOISE/HARMONIC PERFORMANCE | | | | | |
| Second/Third Harmonic Distortion | $A_V = 6 \text{ dB}, R_L = 200 \Omega, V_{OUT} = 2 \text{ V p-p}$ | | -104/-87 | | dBc |
| | $A_V = 12 \text{ dB}, R_L = 200 \Omega, V_{OUT} = 2 \text{ V p-p}$ | | -82/-81 | | dBc |
| | $A_V = 15.5 \text{ dB}, R_L = 200 \Omega, V_{OUT} = 2 \text{ V p-p}$ | | -80/-80 | | dBc |
| Output Third-Order Intercept/Third-Order Intermodulation Distortion | $A_V = 6 \text{ dB}, R_L = 200 \Omega, V_{OUT} = 2 \text{ V p-p composite}$ (2 MHz spacing) | | +47/-100 | | dBm/dBc |
| | $A_V = 12 \text{ dB}, R_L = 200 \Omega, V_{OUT} = 2 \text{ V p-p composite}$ (2 MHz spacing) | | +45/-95 | | dBm/dBc |
| | $A_V = 15.5 \text{ dB}, R_L = 200 \Omega, V_{OUT} = 2 \text{ V p-p composite}$ (2 MHz spacing) | | +43/-92 | | dBm/dBc |
| Noise Spectral Density (RTI) | $A_V = 6 \text{ dB}$ | | 3 | | nV/ $\sqrt{\text{Hz}}$ |
| | $A_V = 12 \text{ dB}$ | | 2.1 | | nV/ $\sqrt{\text{Hz}}$ |
| | $A_V = 15.5 \text{ dB}$ | | 1.6 | | nV/ $\sqrt{\text{Hz}}$ |
| 1 dB Compression Point (RTO) | $A_V = 6 \text{ dB}$ | | 13.4 | | dBm |
| | $A_V = 12 \text{ dB}$ | | 13.3 | | dBm |
| | $A_V = 15.5 \text{ dB}$ | | 12.4 | | dBm |

| Parameter | Conditions | Min | Typ | Max | Unit |
|---|---|-----|---------|-----|------------------------|
| 250 MHz NOISE/HARMONIC PERFORMANCE | | | | | |
| Second/Third Harmonic Distortion | $A_V = 6 \text{ dB}, R_L = 200 \Omega, V_{OUT} = 2 \text{ V p-p}$ | | -80/-94 | | dBc |
| | $A_V = 12 \text{ dB}, R_L = 200 \Omega, V_{OUT} = 2 \text{ V p-p}$ | | -74/-86 | | dBc |
| | $A_V = 15.5 \text{ dB}, R_L = 200 \Omega, V_{OUT} = 2 \text{ V p-p}$ | | -74/-84 | | dBc |
| Output Third-Order Intercept/Third-Order Intermodulation Distortion | $A_V = 6 \text{ dB}, R_L = 200 \Omega, V_{OUT} = 2 \text{ V p-p composite}$ (2 MHz spacing) | | +43/-94 | | dBm/dBc |
| | $A_V = 12 \text{ dB}, R_L = 200 \Omega, V_{OUT} = 2 \text{ V p-p composite}$ (2 MHz spacing) | | +41/-87 | | dBm/dBc |
| | $A_V = 15.5 \text{ dB}, R_L = 200 \Omega, V_{OUT} = 2 \text{ V p-p composite}$ (2 MHz spacing) | | +40/-86 | | dBm/dBc |
| Noise Spectral Density (RTI) | $A_V = 6 \text{ dB}$ | | 3.2 | | nV/ $\sqrt{\text{Hz}}$ |
| | $A_V = 12 \text{ dB}$ | | 2.2 | | nV/ $\sqrt{\text{Hz}}$ |
| | $A_V = 15.5 \text{ dB}$ | | 1.6 | | nV/ $\sqrt{\text{Hz}}$ |
| 1 dB Compression Point (RTO) | $A_V = 6 \text{ dB}$ | | 13 | | dBm |
| | $A_V = 12 \text{ dB}$ | | 13 | | dBm |
| | $A_V = 15.5 \text{ dB}$ | | 12 | | dBm |
| 500 MHz NOISE/HARMONIC PERFORMANCE | | | | | |
| Second/Third Harmonic Distortion | $A_V = 6 \text{ dB}, R_L = 200 \Omega, V_{OUT} = 1 \text{ V p-p}$ | | -75/-69 | | dBc |
| | $A_V = 12 \text{ dB}, R_L = 200 \Omega, V_{OUT} = 1 \text{ V p-p}$ | | -69/-73 | | dBc |
| | $A_V = 15.5 \text{ dB}, R_L = 200 \Omega, V_{OUT} = 1 \text{ V p-p}$ | | -72/-75 | | dBc |
| Output Third-Order Intercept/Third-Order Intermodulation Distortion | $A_V = 6 \text{ dB}, R_L = 200 \Omega, V_{OUT} = 1 \text{ V p-p composite}$ (2 MHz spacing) | | +40/-98 | | dBm/dBc |
| | $A_V = 12 \text{ dB}, R_L = 200 \Omega, V_{OUT} = 1 \text{ V p-p composite}$ (2 MHz spacing) | | +39/-97 | | dBm/dBc |
| | $A_V = 15.5 \text{ dB}, R_L = 200 \Omega, V_{OUT} = 1 \text{ V p-p composite}$ (2 MHz spacing) | | +38/-93 | | dBm/dBc |
| Noise Spectral Density (RTI) | $A_V = 6 \text{ dB}$ | | 3.7 | | nV/ $\sqrt{\text{Hz}}$ |
| | $A_V = 12 \text{ dB}$ | | 2.2 | | nV/ $\sqrt{\text{Hz}}$ |
| | $A_V = 15.5 \text{ dB}$ | | 1.6 | | nV/ $\sqrt{\text{Hz}}$ |
| 1000 MHz NOISE/HARMONIC PERFORMANCE | | | | | |
| Second/Third Harmonic Distortion | $A_V = 6 \text{ dB}, R_L = 200 \Omega, V_{OUT} = 1 \text{ V p-p}$ | | -70/-60 | | dBc |
| | $A_V = 12 \text{ dB}, R_L = 200 \Omega, V_{OUT} = 1 \text{ V p-p}$ | | -69/-61 | | dBc |
| | $A_V = 15.5 \text{ dB}, R_L = 200 \Omega, V_{OUT} = 1 \text{ V p-p}$ | | -66/-59 | | dBc |
| Output Third-Order Intercept/Third-Order Intermodulation Distortion | $A_V = 6 \text{ dB}, R_L = 200 \Omega, V_{OUT} = 1 \text{ V p-p composite}$ (2 MHz spacing) | | +24/-65 | | dBm/dBc |
| | $A_V = 12 \text{ dB}, R_L = 200 \Omega, V_{OUT} = 1 \text{ V p-p composite}$ (2 MHz spacing) | | +24/-66 | | dBm/dBc |
| | $A_V = 15.5 \text{ dB}, R_L = 200 \Omega, V_{OUT} = 1 \text{ V p-p composite}$ (2 MHz spacing) | | +25/-66 | | dBm/dBc |
| Noise Spectral Density (RTI) | $A_V = 6 \text{ dB}$ | | 4.7 | | nV/ $\sqrt{\text{Hz}}$ |
| | $A_V = 12 \text{ dB}$ | | 2.2 | | nV/ $\sqrt{\text{Hz}}$ |
| | $A_V = 15.5 \text{ dB}$ | | 1.6 | | nV/ $\sqrt{\text{Hz}}$ |

¹ See the Applications Information section for a discussion of single-ended input, dc-coupled operation.

ABSOLUTE MAXIMUM RATINGS

Table 2.

| Parameter | Rating |
|------------------------------|-----------------|
| Supply Voltage (VCC) | 3.6 V |
| VIP1, VIP2, VIN1, VIN2 | VCC + 0.5 V |
| Internal Power Dissipation | 310 mW |
| θ_{JA} | 98.3°C/W |
| Maximum Junction Temperature | 125°C |
| Operating Temperature Range | -40°C to +85°C |
| Storage Temperature Range | -65°C to +150°C |

Stresses at or above those listed under Absolute Maximum Ratings may cause permanent damage to the product. This is a stress rating only; functional operation of the product at these or any other conditions above those indicated in the operational section of this specification is not implied. Operation beyond the maximum operating conditions for extended periods may affect product reliability.

ESD CAUTION



ESD (electrostatic discharge) sensitive device. Charged devices and circuit boards can discharge without detection. Although this product features patented or proprietary protection circuitry, damage may occur on devices subjected to high energy ESD. Therefore, proper ESD precautions should be taken to avoid performance degradation or loss of functionality.

PIN CONFIGURATION AND FUNCTION DESCRIPTIONS

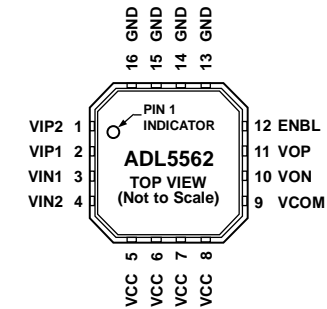

NOTES

- EXPOSED PADDLE. CONNECT TO A LOW IMPEDANCE THERMAL AND ELECTRICAL GROUND PLANE.

08003-031

Figure 2. Pin Configuration

Table 3. Pin Function Descriptions

| Pin No. | Mnemonic | Description |
|----------------|----------|--|
| 1 | VIP2 | Balanced Differential Input. Biased to VCOM, typically ac-coupled. Input for $A_v = 12$ dB gain, strapped to VIP1 for $A_v = 15.5$ dB. |
| 2 | VIP1 | Balanced Differential Input. Biased to VCOM, typically ac-coupled. Input for $A_v = 6$ dB gain, strapped to VIP2 for $A_v = 15.5$ dB. |
| 3 | VIN1 | Balanced Differential Input. Biased to VCOM, typically ac-coupled. Input for $A_v = 6$ dB gain, strapped to VIN2 for $A_v = 15.5$ dB. |
| 4 | VIN2 | Balanced Differential Input. Biased to VCOM, typically ac-coupled. Input for $A_v = 12$ dB gain, strapped to VIN1 for $A_v = 15.5$ dB. |
| 5, 6, 7, 8 | VCC | Positive Supply. |
| 9 | VCOM | Common-Mode Voltage. A voltage applied to this pin sets the common-mode voltage of the input and output. Typically decoupled to ground with a $0.1 \mu\text{F}$ capacitor. With no reference applied, input and output common mode floats to midsupply ($V_{CC}/2$). |
| 10 | VON | Balanced Differential Output. Biased to VCOM, typically ac-coupled. |
| 11 | VOP | Balanced Differential Output. Biased to VCOM, typically ac-coupled. |
| 12 | ENBL | Enable. Apply positive voltage ($1.0 \text{ V} < \text{ENBL} < V_{CC}$) to activate device. |
| 13, 14, 15, 16 | GND | Ground. Connect to low impedance ground. |
| | EPAD | Exposed Pad. Connect to a low impedance thermal and electrical ground plane. |

TYPICAL PERFORMANCE CHARACTERISTICS

VCC = 3.3 V, VCOM = 1.65 V, RL = 200 Ω differential, Av = 6 dB, CL = 1 pF differential, f = 140 MHz, T = 25°C.

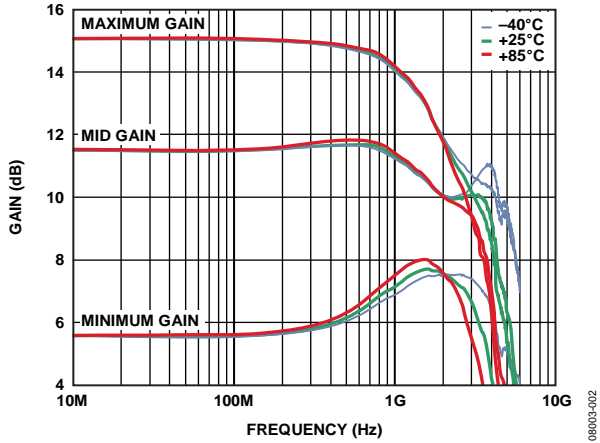

Figure 3. Gain vs. Frequency Response for 200 Ω Differential Load, Av = 6 dB, Av = 12 dB, and Av = 15.5 dB over Temperature

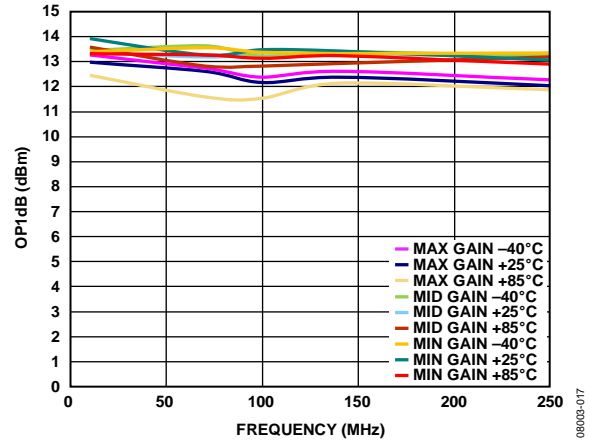

Figure 6. Output P1dB (OP1dB) vs. Frequency at Av = 6 dB, Av = 12 dB, and Av = 15.5 dB over Temperature, 200 Ω Differential Load

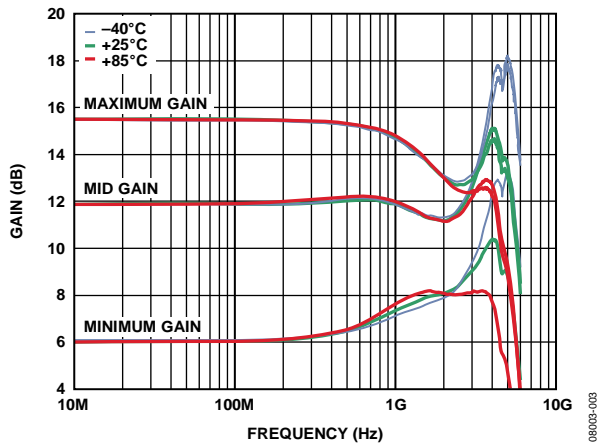

Figure 4. Gain vs. Frequency Response for 1 kΩ Differential Load, Av = 6 dB, Av = 12 dB, and Av = 15.5 dB over Temperature

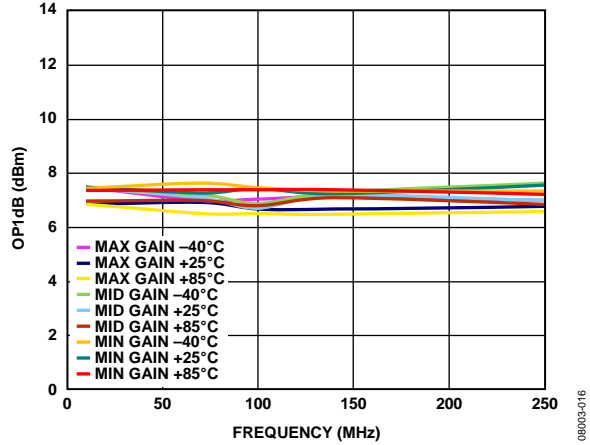

Figure 7. Output P1dB (OP1dB) vs. Frequency at Av = 6 dB, Av = 12 dB, and Av = 15.5 dB over Temperature, 1 kΩ Differential Load

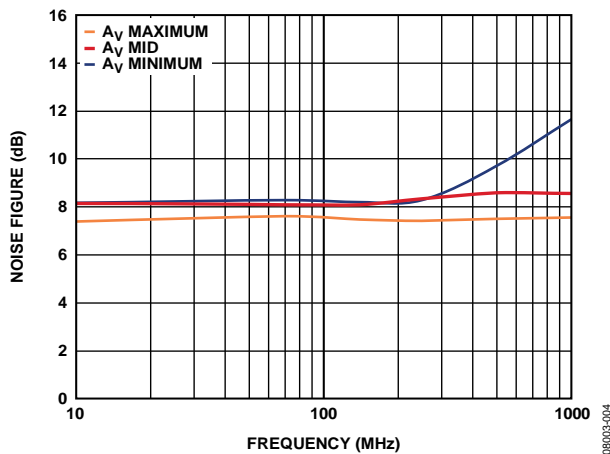

Figure 5. Noise Figure vs. Frequency at Av = 6 dB, Av = 12 dB, and Av = 15.5 dB

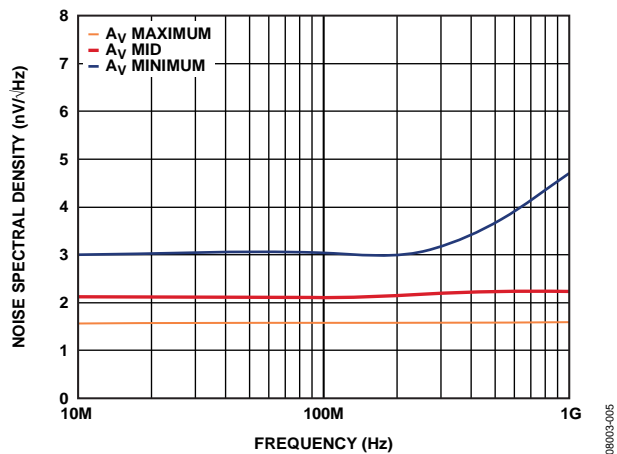

Figure 8. Noise Spectral Density vs. Frequency at Av = 6 dB, Av = 12 dB, and Av = 15.5 dB

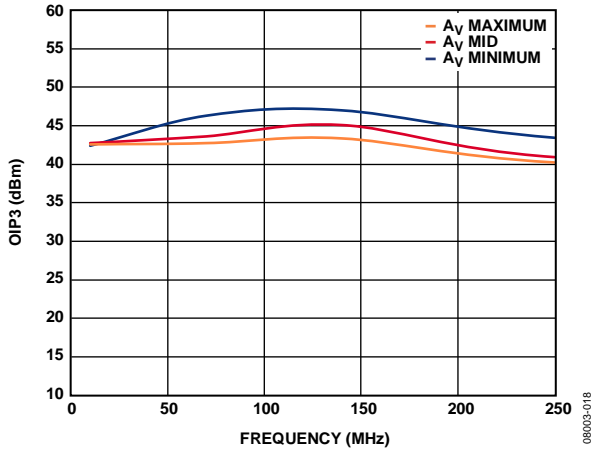

Figure 9. Output Third-Order Intercept at Three Gains, Output Level at 2 V p-p Composite, $R_L = 200 \Omega$

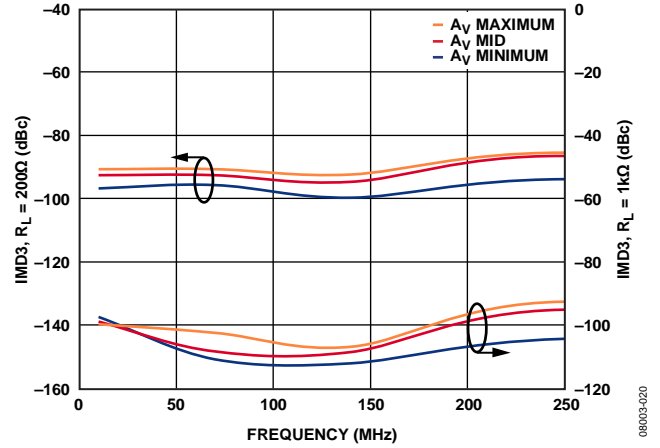

Figure 12. Two-Tone Output IMD vs. Frequency, Output Level at 2 V p-p Composite, $R_L = 200 \Omega$ and $R_L = 1 k\Omega$

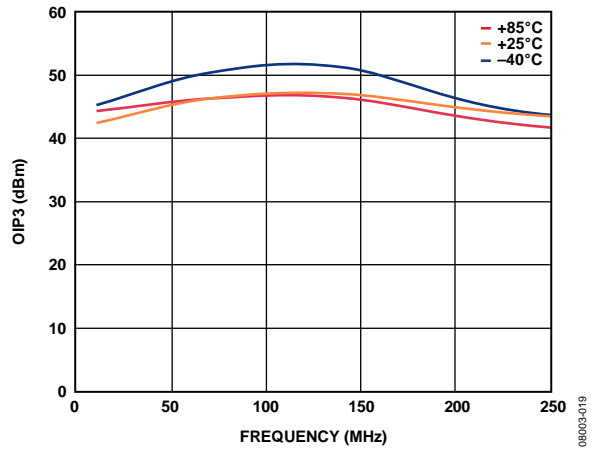

Figure 10. Output Third-Order Intercept vs. Frequency, Over Temperature, Output Level at 2 V p-p Composite, $R_L = 200 \Omega$

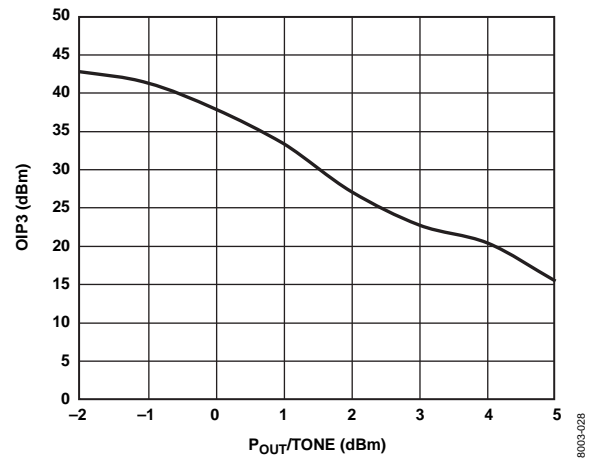

Figure 13. Output Third-Order Intercept (OIP3) vs. Power (P_{OUT}), Frequency 140 MHz, $A_V = 15.5 \text{ dB}$

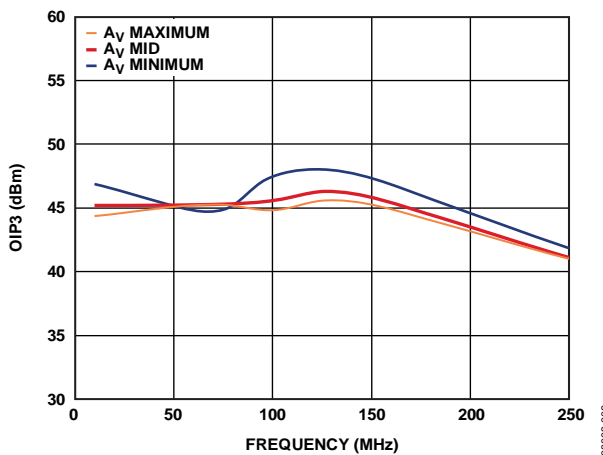

Figure 11. OIP3 vs. Frequency (Single-Ended Input)

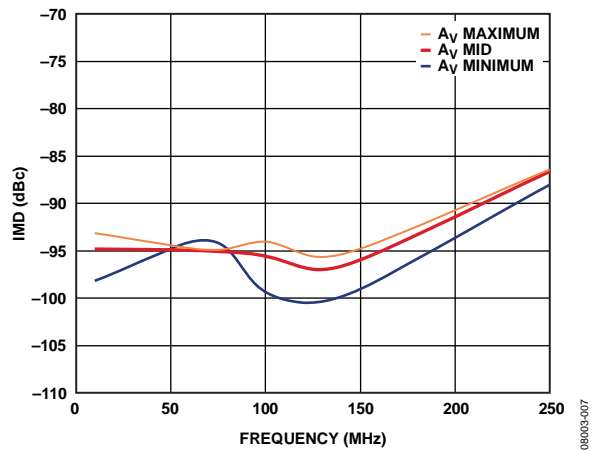

Figure 14. IMD vs. Frequency (Single-Ended Input)

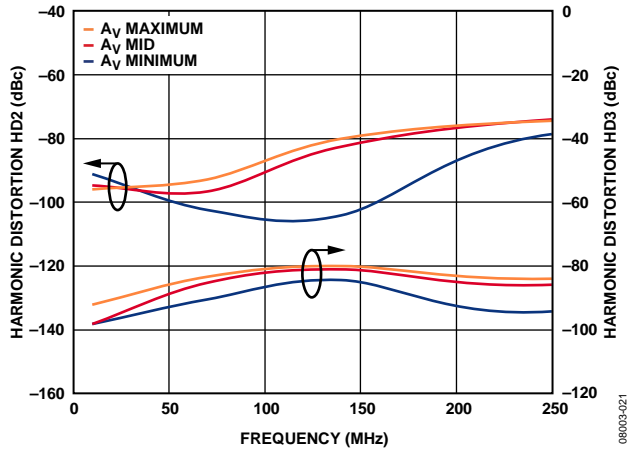

Figure 15. Harmonic Distortion (HD2/HD3) vs. Frequency at $A_v = 6$ dB, $A_v = 12$ dB, and $A_v = 15.5$ dB, Output Level at 2 V p-p, $R_L = 200 \Omega$

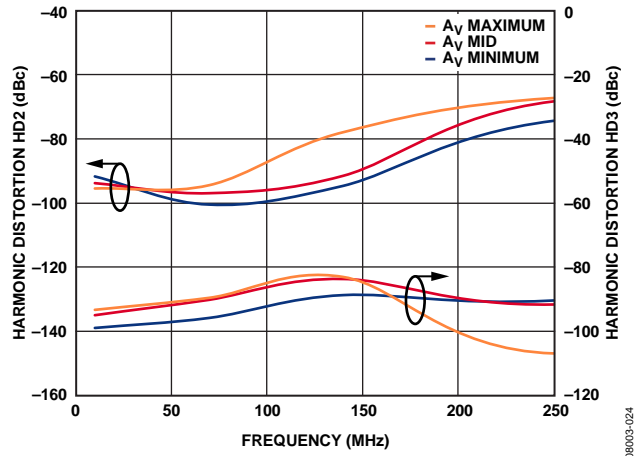

Figure 18. Harmonic Distortion (HD2/HD3) vs. Frequency at $A_v = 6$ dB, $A_v = 12$ dB, and $A_v = 15.5$ dB, Output Level at 2 V p-p, $R_L = 1 k\Omega$

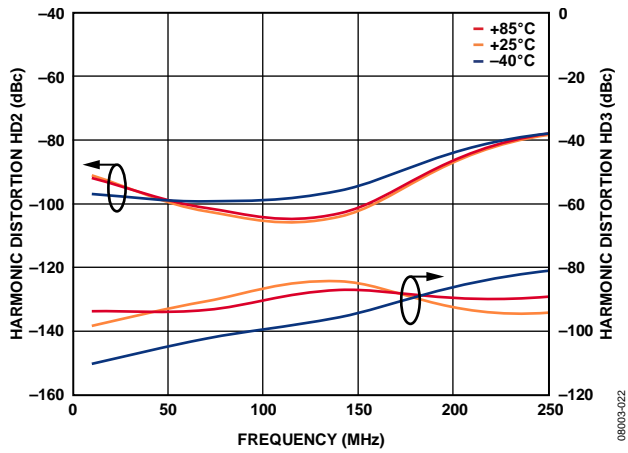

Figure 16. Harmonic Distortion (HD2/HD3) vs. Frequency, Three Temperatures, Output Level at 2 V p-p, $R_L = 200 \Omega$

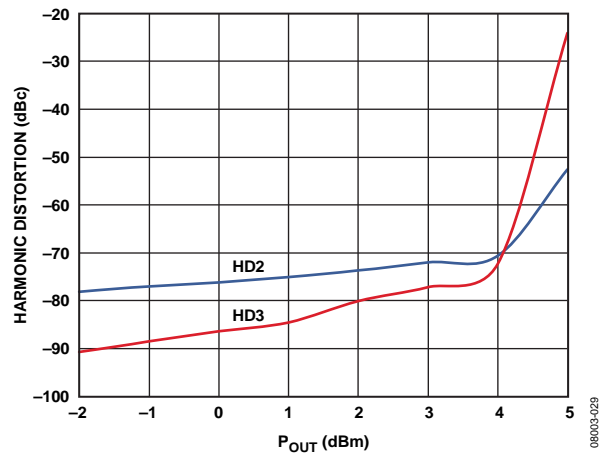

Figure 19. Harmonic Distortion (HD2/HD3) vs. Power (P_{OUT}), Frequency 140 MHz, $A_v = 15.5$ dB

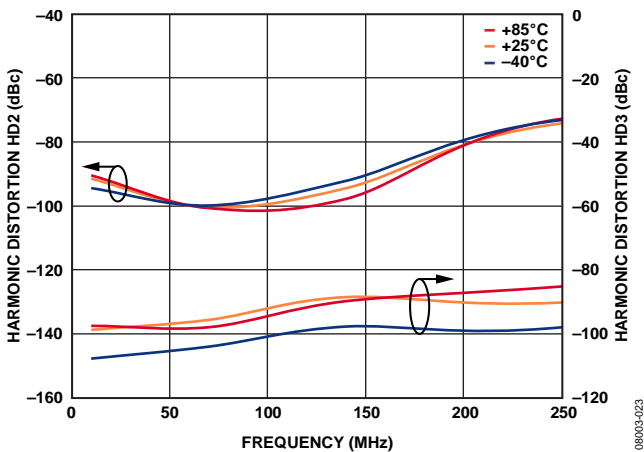

Figure 17. Harmonic Distortion (HD2/HD3) vs. Frequency, Over Temperature, Output Level at 2 V p-p, $R_L = 1 k\Omega$

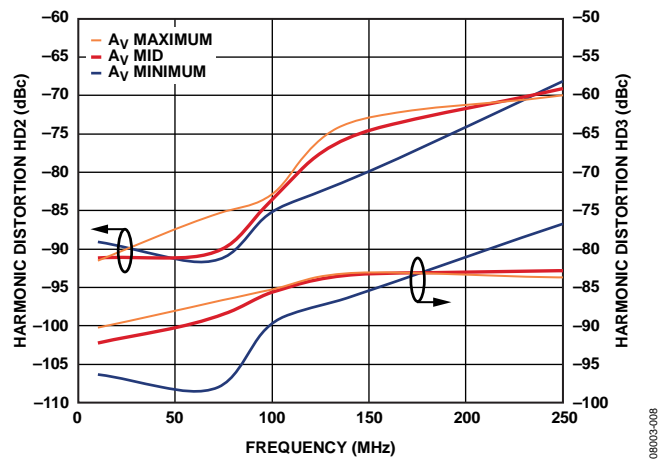

Figure 20. Harmonic Distortion (HD2/HD3) vs. Frequency (Single-Ended Input)

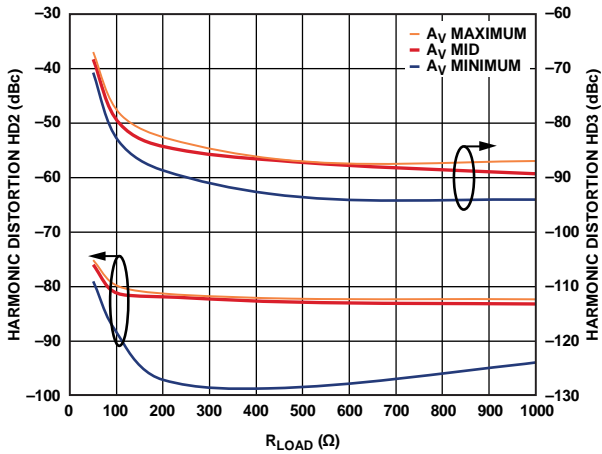

Figure 21. Harmonic Distortion (HD2/HD3) vs. R_{LOAD}

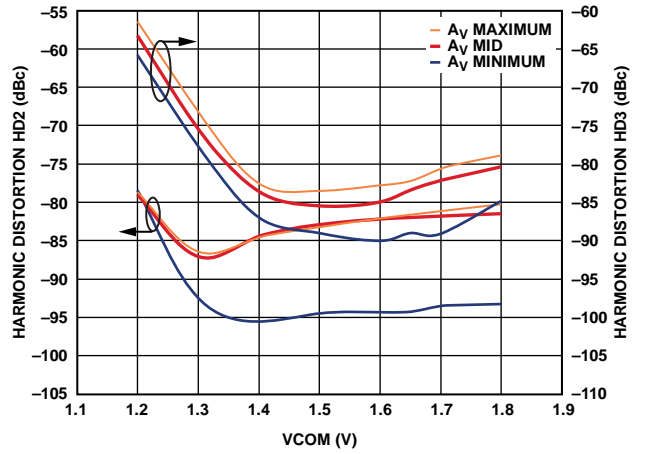

Figure 24. Harmonic Distortion (HD2/HD3) vs. V_{COM}

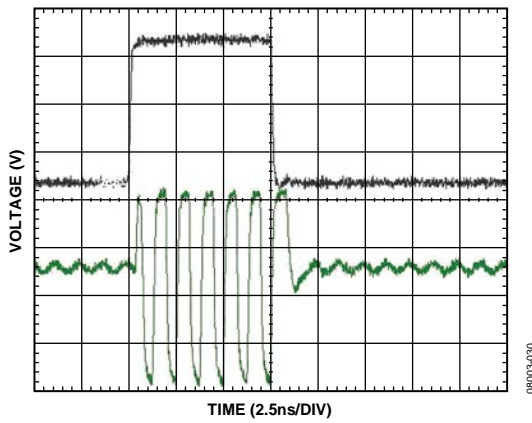

Figure 22. ENBL Time Domain Response

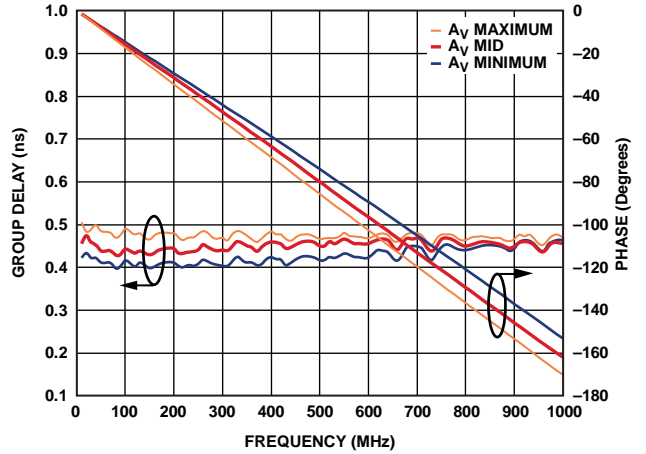

Figure 25. Group Delay and Phase vs. Frequency

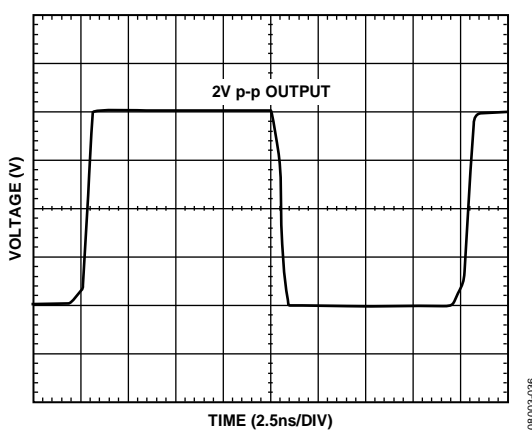

Figure 23. Large Signal Pulse Response, $A_V = 15.5$ dB

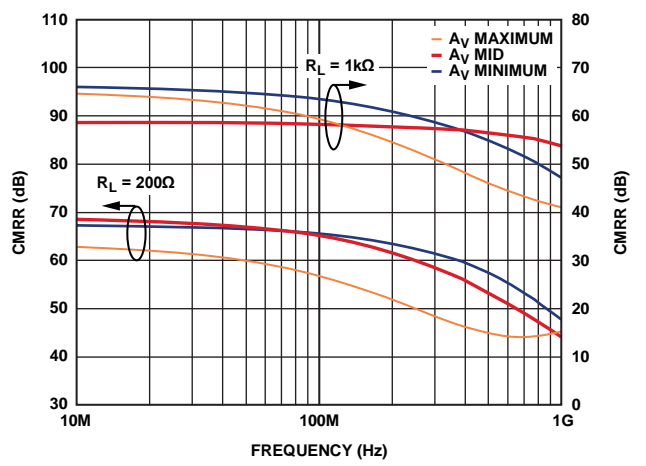

Figure 26. Common-Mode Rejection Ratio (CMRR) vs. Frequency

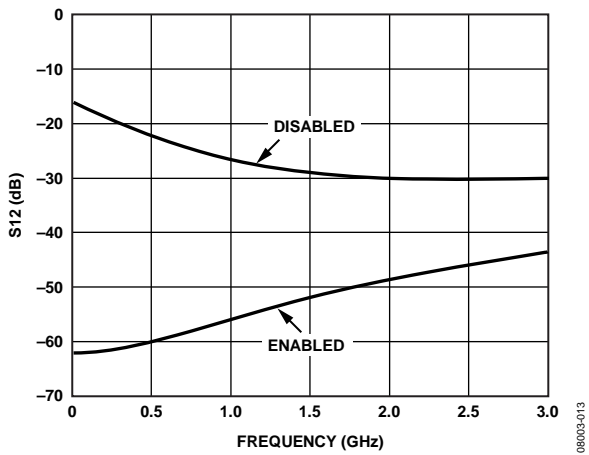

Figure 27. Reverse Isolation (S_{12}) vs. Frequency

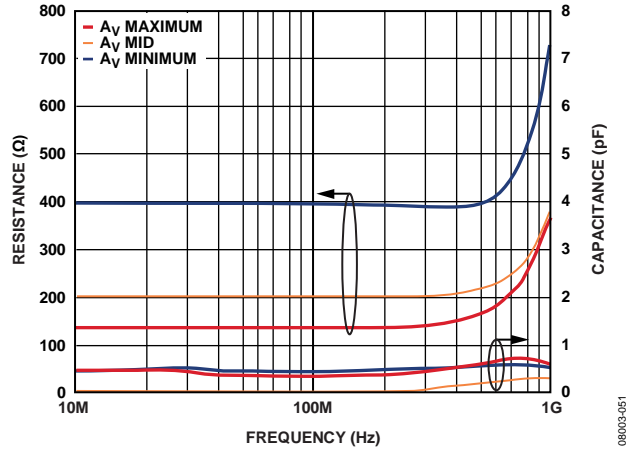

Figure 30. Input Resistance and Capacitance vs. Frequency

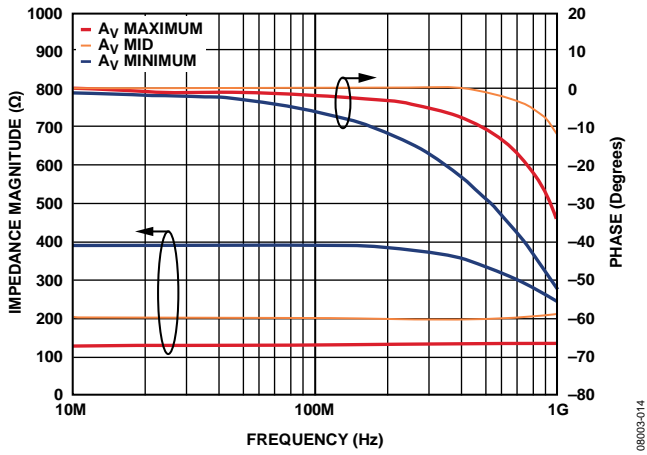

Figure 28. Input Impedance vs. Frequency

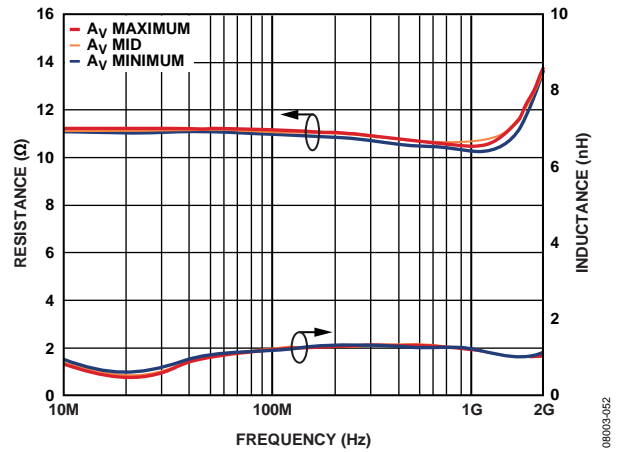

Figure 31. Output Resistance and Inductance vs. Frequency

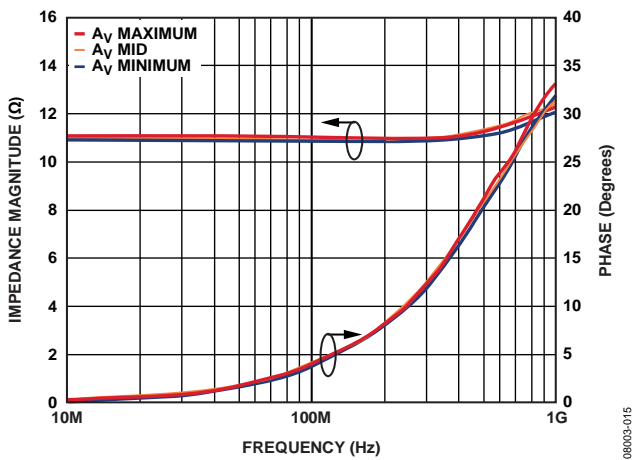

Figure 29. Output Impedance vs. Frequency

CIRCUIT DESCRIPTION

BASIC STRUCTURE

The [ADL5562](#) is a low noise, fully differential amplifier/ADC driver that uses a 3.3 V supply. It provides three gain options (6 dB, 12 dB, and 15.5 dB) without the need for external resistors and has wide bandwidths of 2.6 GHz for 6 dB, 2.3 GHz for 12 dB, and 2.1 GHz for 15.5 dB. Differential input impedance is 400 Ω for 6 dB, 200 Ω for 12 dB, and 133 Ω for 15.5 dB. It has a differential output impedance of 10 Ω and a common-mode adjust voltage of 1.25 V to 1.85 V.

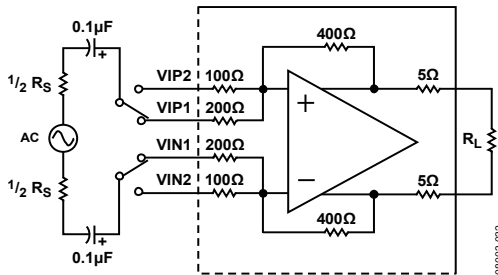

Figure 32. Basic Structure

The [ADL5562](#) is composed of a fully differential amplifier with on-chip feedback and feed-forward resistors. The two feed-forward resistors on each input set this pin-strappable amplifier in three different gain configurations of 6 dB, 12 dB, and 15.5 dB. The amplifier is designed to provide high differential open-loop gain and an output common-mode circuit that enables the user to change the common-mode voltage from a VCOM pin. The amplifier is designed to provide superior low distortion at frequencies up to and beyond 300 MHz with low noise and low power consumption. The low distortion and noise are realized with a 3.3 V power supply at 80 mA.

The [ADL5562](#) is very flexible in terms of I/O coupling. It can be ac-coupled or dc-coupled at the inputs and/or the outputs within the specified input and output common-mode levels. The input of the device can be configured as single-ended or differential with similar distortion performance. Due to the internal connections between the inputs and outputs, keep the output common-mode voltage between 1.25 V and 1.85 V for the best distortion. For a dc-coupled input, the input common mode must be between 1 V and 2.3 V for the best distortion. The device has been characterized using 2 V p-p into 200 Ω . If the inputs are ac-coupled, the input and output common-mode voltages are set by $V_{CC}/2$ when no external circuitry is used. The [ADL5562](#) provides an output common-mode voltage set by VCOM, which allows driving an ADC directly without external components, such as a transformer or ac coupling capacitors, provided the VCOM of the amplifier is within the VCOM of the ADC. For dc-coupled requirements, the input VCM must be set by the VCOM pin in all three gain settings.

APPLICATIONS INFORMATION

BASIC CONNECTIONS

Figure 33 shows the basic connections for operating the [ADL5562](#). VCC must be 3.3 V with each supply pin decoupled with at least one low inductance surface-mount ceramic capacitor of 0.1 μF placed as close as possible to the device. The VCOM pin (Pin 9) must also be decoupled using a 0.1 μF capacitor.

The gain of the part is determined by the pin-strappable input configuration. When Input A is applied to VIP1 and Input B is applied to VIN1, the gain is 6 dB (minimum gain, see Equation 1 and Equation 2). When Input A is applied to VIP2 and Input B is applied to VIN2, the gain is 12 dB (middle gain). When Input A is applied to VIP1 and VIP2 and Input B is applied to VIN1 and VIN2, the gain is 15.5 dB (maximum gain).

Pin 1 to Pin 4, Pin 10, and Pin 11 are biased at $1/2$ VCC above ground and can be dc-coupled (if within the specified input or output common-mode voltage levels) or ac-coupled as shown in Figure 33.

To enable the [ADL5562](#), the ENBL pin must be pulled high. Pulling the ENBL pin low puts the [ADL5562](#) in sleep mode, reducing the current consumption to 3 mA at ambient.

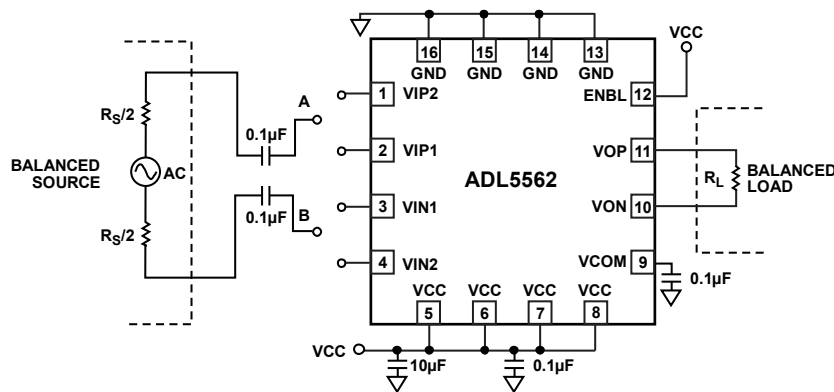
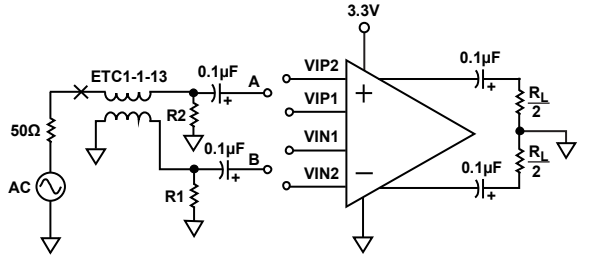

Figure 33. Basic Connections

086003-033

INPUT AND OUTPUT INTERFACING

The ADL5562 can be configured as a differential-input to differential-output driver, as shown in Figure 34. The differential broadband input is provided by the ETC1-1-13 balun transformer, and the two 34.8 Ω resistors provide a 50 Ω input match for the three input impedances that change with the variable gain strapping. The input and output 0.1 μF capacitors isolate the VCC/2 bias from the source and balanced load. The load must equal 200 Ω to provide the expected ac performance (see the Specifications section and the Typical Performance Characteristics section).



- NOTES**
1. FOR 6dB GAIN ($A_V = 2$), CONNECT INPUT A TO VIP1 AND INPUT B TO VIN1.
 2. FOR 12dB GAIN ($A_V = 4$), CONNECT INPUT A TO VIP2 AND INPUT B TO VIN2.
 3. FOR 15.5dB GAIN ($A_V = 6$), CONNECT INPUT A TO BOTH VIP1 AND VIP2 AND INPUT B TO BOTH VIN1 AND VIN2.

Figure 34. Differential-Input to Differential-Output Configuration

Table 4. Differential Termination Values for Figure 34

| Gain (dB) | R1 (Ω) | R2 (Ω) |
|-----------|--------|--------|
| 6 | 28.7 | 28.7 |
| 12 | 33.2 | 33.2 |
| 15.5 | 40.2 | 40.2 |

The differential gain of the ADL5562 is dependent on the source impedance and load, as shown in Figure 35.

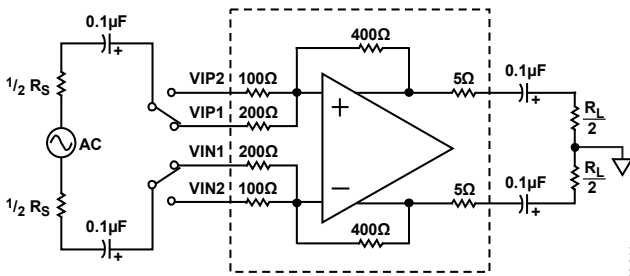

Figure 35. Differential Input Loading Circuit

The differential gain can be determined using the following formula. The values of R_{IN} for each gain configuration are shown in Table 5.

$$A_V = \frac{400}{R_{IN}} \times \frac{R_L}{10 + R_L} \tag{1}$$

Table 5. Values of R_{IN} for Differential Gain

| Gain (dB) | R_{IN} (Ω) |
|-----------|--------------|
| 6 | 200 |
| 12 | 100 |
| 15.5 | 66.7 |

Single-Ended Input to Differential Output

The ADL5562 can also be configured in a single-ended input to differential output driver, as shown in Figure 36. In this configuration, the gain of the part is reduced due to the application of the signal to only one side of the amplifier. The strappable gain values are listed in Table 6 with the required terminations to match to a 50 Ω source using R1 and R2. Note that R1 must equal the parallel value of the source and R2. The input and output 0.1 μF capacitors isolate the VCC/2 bias from the source and the balanced load. The performance for this configuration is shown in Figure 11, Figure 14, and Figure 20.

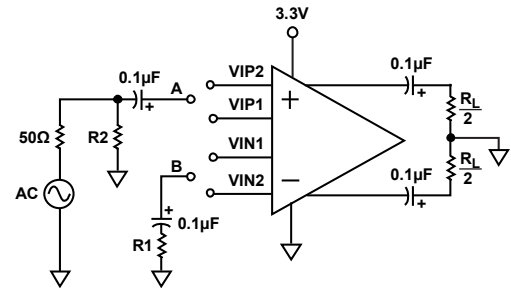

- NOTES**
1. FOR 5.6dB GAIN ($A_V = 1.9$), CONNECT INPUT A TO VIP1 AND INPUT B TO VIN1.
 2. FOR 11.1dB GAIN ($A_V = 3.6$), CONNECT INPUT A TO VIP2 AND INPUT B TO VIN2.
 3. FOR 14.1dB GAIN ($A_V = 5.1$), CONNECT INPUT A TO BOTH VIP1 AND VIP2 AND INPUT B TO BOTH VIN1 AND VIN2.

Figure 36. Single-Ended Input to Differential Output Configuration

Table 6. Single-Ended Termination Values for Figure 36

| Gain (dB) | R1 (Ω) | R2 (Ω) |
|-----------|--------|--------|
| 5.6 | 27 | 60 |
| 11.1 | 29 | 69 |
| 14.1 | 30 | 77 |

The single-ended gain configuration of the ADL5562 is dependent on the source impedance and load, as shown in Figure 37.

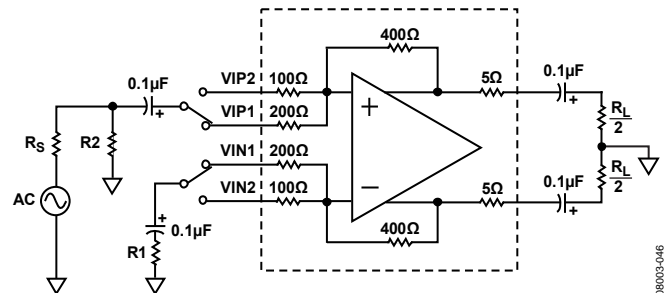

Figure 37. Single-Ended Input Loading Circuit

The single-ended gain can be determined using the following formula. The values of R_{IN} and R_X for each gain configuration are shown in Table 7.

$$A_{V1} = \frac{400}{R_{IN} + \left(\frac{R_S \times R2}{R_S + R2}\right)} \times \frac{R2}{R_S + R2} \times \frac{R_X + R_S}{R_X} \times \frac{R_L}{10 + R_L} \quad (2)$$

Table 7. Values of R_{IN} and R_X for Single-Ended Gain

| Gain (dB) | R_{IN} (Ω) | R_X (Ω) |
|-----------|-----------------------|----------------------|
| 5.6 | 200 | $R2 \parallel 307^1$ |
| 11.1 | 100 | $R2 \parallel 179^1$ |
| 14.1 | 66.7 | $R2 \parallel 132^1$ |

¹ These values based on a 50 Ω input match.

GAIN ADJUSTMENT AND INTERFACING

The effective gain of the ADL5562 can be reduced using a number of techniques. A matched attenuator network can reduce the effective gain; however, this requires the addition of a separate component that can be prohibitive in size and cost. Instead, a simple voltage divider can be implemented using the combination of additional series resistors at the amplifier input and the input impedance of the ADL5562, as shown in Figure 38. A shunt resistor is used to match to the impedance of the previous stage.

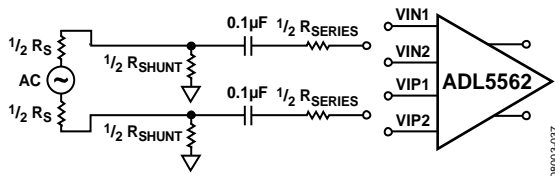

Figure 38. Gain Adjustment Using a Series Resistor

Figure 38 shows a typical implementation of the divider concept that effectively reduces the gain by adding attenuation at the input. For frequencies less than 100 MHz, the input impedance of the ADL5562 can be modeled as a real 133 Ω , 200 Ω , or 400 Ω resistance (differential) for maximum, middle, and minimum gains, respectively. Assuming that the frequency is low enough to ignore the shunt reactance of the input and high enough so that the reactance of moderately sized ac coupling capacitors can be considered negligible, the insertion loss, Il , due to the shunt divider can be expressed as

$$Il(dB) = 20 \log \left(\frac{R_{IN}}{R_{SERIES} + R_{IN}} \right) \quad (3)$$

The necessary shunt component, R_{SHUNT} , to match to the source impedance, R_S , can be expressed as

$$R_{SHUNT} = \frac{1}{\frac{1}{R_S} - \frac{1}{R_{SERIES} + R_{IN}}} \quad (4)$$

The insertion loss and the resultant power gain for multiple shunt resistor values are summarized in Table 8. The source resistance and input impedance need careful attention when using Equation 3 and Equation 4. The reactance of the input impedance of the ADL5562 and the ac coupling capacitors must be considered before assuming that they make a negligible contribution.

Table 8. Gain Adjustment Using Series Resistor

| Il (dB) | R_{IN} (Ω) | R_S (Ω) | R_{SERIES} (Ω) | R_{SHUNT} (Ω) |
|---------|-----------------------|--------------------|---------------------------|--------------------------|
| 2 | 400 | 50 | 105 | 54.9 |
| 4 | 400 | 50 | 232 | 54.9 |
| 2 | 200 | 50 | 51.1 | 61.9 |
| 4 | 200 | 50 | 115 | 59 |
| 2 | 133 | 50 | 34.8 | 71.5 |
| 2 | 400 | 200 | 102 | 332 |
| 4 | 400 | 200 | 232 | 294 |
| 2 | 200 | 200 | 51.1 | 976 |
| 4 | 200 | 200 | 115 | 549 |
| 2 | 400 | 50 | 105 | 54.9 |
| 4 | 400 | 50 | 232 | 54.9 |
| 2 | 200 | 50 | 51.1 | 61.9 |

ADC INTERFACING

The ADL5562 is a high output linearity amplifier that is optimized for ADC interfacing. There are several options available to the designer when using the ADL5562. Figure 39 shows a simplified wideband interface with the ADL5562 driving the AD9445. The AD9445 is a 14-bit, 125 MSPS ADC with a buffered wideband input.

For optimum performance, drive the ADL5562 differentially using an input balun. Figure 39 uses a wideband 1:1 transmission line balun followed by two 34.8 Ω resistors in parallel with the three input impedances (which change with the gain selection of the ADL5562) to provide a 50 Ω differential input impedance. This provides a wideband match to a 50 Ω source. The ADL5562 is ac-coupled from the AD9445 to avoid common-mode dc loading. The 33 Ω series resistors help to improve the isolation between the ADL5562 and any switching currents present at the analog-to-digital sample-and-hold input circuitry. The AD9445 input presents a 2 k Ω differential load impedance and requires a 2 V p-p differential input swing to reach full scale ($V_{REF} = 1$ V).

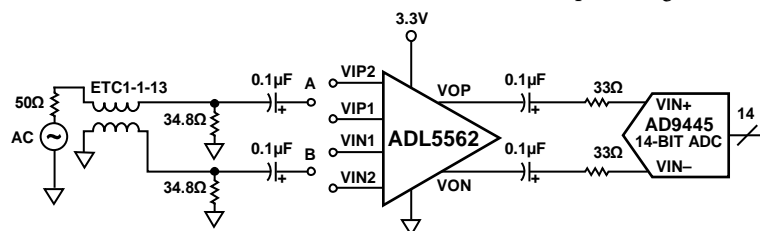

Figure 39. Wideband ADC Interfacing Example Featuring the AD9445

This circuit provides variable gain, isolation, and source matching for the AD9445. Using this circuit with the ADL5562 in a gain of 6 dB, an SFDR performance of 87 dBc is achieved at 140 MHz, and a -3 dB bandwidth of 760 MHz, as indicated in Figure 40 and Figure 41.

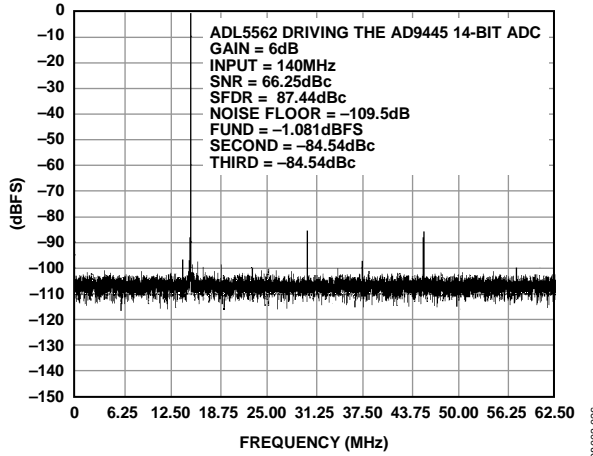

Figure 40. Measured Single-Tone Performance of the Circuit in Figure 39 for a 100 MHz Input Signal

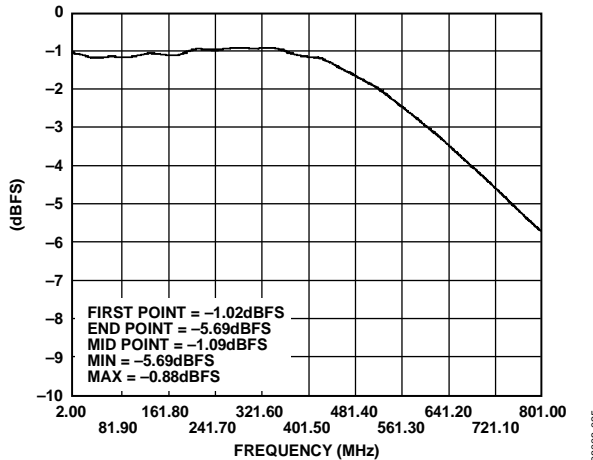

Figure 41. Measured Frequency Response of the Wideband ADC Interface Depicted in Figure 39

The wideband frequency response is an advantage in broadband applications, such as predistortion receiver designs and instrumentation applications. However, by designing for a wide analog input frequency range, the cascaded SNR performance is somewhat degraded due to high frequency noise aliasing into the wanted Nyquist zone.

An alternative narrow-band approach is presented in Figure 42. By designing a narrow band-pass antialiasing filter between the ADL5562 and the target ADC, the output noise of the ADL5562 outside of the intended Nyquist zone can be attenuated, helping to preserve the available SNR of the ADC. In general, the SNR improves several decibels when including a reasonable order anti-aliasing filter. In this example, a low loss 1:1 input transformer is used to match the ADL5562 balanced input to a 50 Ω unbalanced source, resulting in minimum insertion loss at the input.

Figure 42 is optimized for driving some of the Analog Devices popular unbuffered ADCs, such as the AD9246, AD9640, and AD6655. Table 9 includes antialiasing filter component recommendations for popular IF sampling center frequencies. Inductor L5 works in parallel with the on-chip ADC input capacitance and a portion of the capacitance presented by C4 to form a resonant tank circuit. The resonant tank helps to ensure that the ADC input looks like a real resistance at the target center frequency. The L5 inductor shorts the ADC inputs at dc, which introduces a zero into the transfer function. In addition, the ac coupling capacitors introduce additional zeros into the transfer function. The final overall frequency response takes on a band-pass characteristic, helping to reject noise outside of the intended Nyquist zone. Table 9 provides initial suggestions for prototyping purposes. Some empirical optimization may be needed to help compensate for actual PCB parasitics.

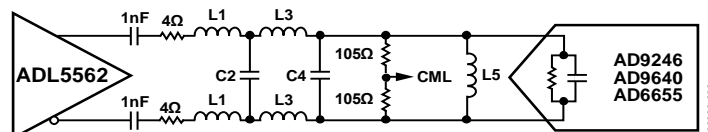

Figure 42. Narrow-Band IF Sampling Solution for an Unbuffered ADC Application

Table 9. Interface Filter Recommendations for Various IF Sampling Frequencies

| Center Frequency (MHz) | 1 dB Bandwidth (MHz) | L1 (nH) | C2 (pF) | L3 (nH) | C4 (pF) | L5 (nH) |
|------------------------|----------------------|---------|---------|---------|---------|---------|
| 96 | 30 | 3.3 | 47 | 27 | 75 | 100 |
| 140 | 33 | 3.3 | 47 | 27 | 33 | 120 |
| 170 | 32 | 3.3 | 56 | 27 | 22 | 110 |
| 211 | 33 | 3.3 | 47 | 27 | 18 | 56 |

LAYOUT CONSIDERATIONS

High-Q inductive drives and loads, as well as stray transmission line capacitance in combination with package parasitics, can potentially form a resonant circuit at high frequencies, resulting in excessive gain peaking or possible oscillation. If RF transmission lines connecting the input or output are used, they must be designed such that stray capacitance at the input/output pins is

minimized. In many board designs, the signal trace widths must be minimal where the driver/receiver is more than one-eighth of the wavelength from the amplifier. This nontransmission line configuration requires that underlying and adjacent ground and low impedance planes be dropped from the signal lines.

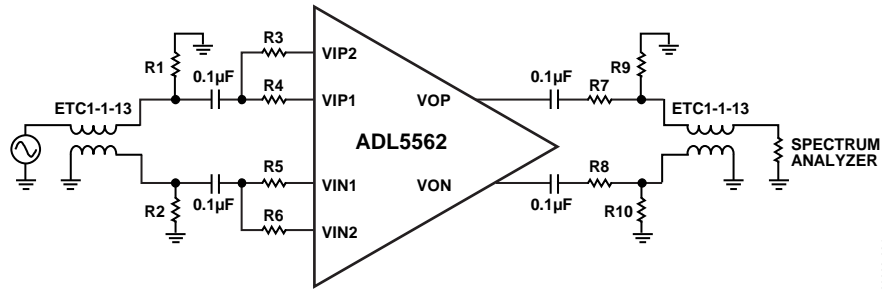

Figure 43. General Purpose Characterization Circuit

Table 10. Gain Setting and Input Termination Components for Figure 43

| A _v (dB) | R1 (Ω) | R2 (Ω) | R3 (Ω) | R4 (Ω) | R5 (Ω) | R6 (Ω) |
|---------------------|--------|--------|--------|--------|--------|--------|
| 6 | 29 | 29 | Open | 0 | 0 | Open |
| 12 | 33 | 33 | 0 | Open | Open | 0 |
| 15.5 | 40.2 | 40.2 | 0 | 0 | 0 | 0 |

Table 11. Output Matching Network for Figure 43

| R _L (Ω) | R7 (Ω) | R8 (Ω) | R9 (Ω) | R10 (Ω) |
|--------------------|--------|--------|--------|---------|
| 200 | 84.5 | 84.5 | 34.8 | 34.8 |
| 1 k | 487 | 487 | 25 | 25 |

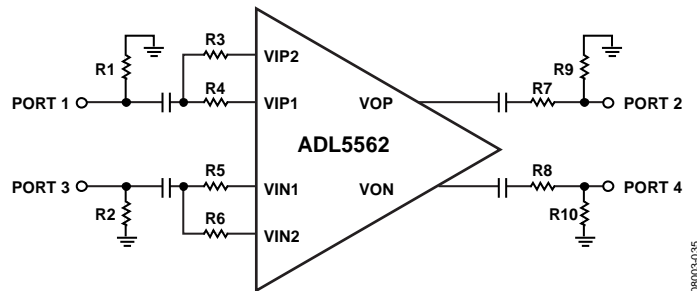

Figure 44. Differential Characterization Circuit Using Agilent E8357A 4-Port PNA

Table 12. Gain Setting and Input Termination Components for Figure 44

| A _v (dB) | R1 (Ω) | R2 (Ω) | R3 (Ω) | R4 (Ω) | R5 (Ω) | R6 (Ω) |
|---------------------|--------|--------|--------|--------|--------|--------|
| 6 | 67 | 67 | Open | 0 | 0 | Open |
| 12 | 100 | 100 | 0 | Open | Open | 0 |
| 15.5 | 200 | 200 | 0 | 0 | 0 | 0 |

Table 13. Output Matching Network for Figure 44

| R _L (Ω) | R7 (Ω) | R8 (Ω) | R9 (Ω) | R10 (Ω) |
|--------------------|--------|--------|--------|---------|
| 200 | 50 | 50 | Open | Open |
| 1 k | 475 | 475 | 61.9 | 61.9 |

SOLDERING INFORMATION

On the underside of the chip scale package, there is an exposed compressed paddle. This paddle is internally connected to the ground of the chip. Solder the paddle to the low impedance ground plane on the PCB to ensure the specified electrical performance and to provide thermal relief. To further reduce thermal impedance, it is recommended that the ground planes on all layers under the paddle be stitched together with vias.

EVALUATION BOARD

Figure 45 shows the schematic of the ADL5562 evaluation board. The board is powered by a single supply in the 3 V to 3.6 V range. The power supply is decoupled by 10 μ F and 0.1 μ F capacitors.

Table 14 details the various configuration options of the evaluation board. Figure 46 and Figure 47 show the component and circuit layouts of the evaluation board.

To realize the minimum gain (6 dB into a 200 Ω load), Input 1 (VIN1 and VIP1) must be used by installing 0 Ω resistors at R3 and R4, leaving R5 and R6 open. R1 and R2 must be 33 Ω for a 50 Ω input impedance.

Likewise, driving Input 2 (VIN2 and VIP2) realizes the middle gain (12 dB into a 200 Ω load) by installing 0 Ω at R5 and R6 and leaving R3 and R4 open. R1 and R2 must be 29 Ω for a 50 Ω input impedance.

For the maximum gain (15.5 dB into a 200 Ω load), both inputs are driven by installing 0 Ω resistors at R3, R4, R5, and R6. R1 and R2 must be 40.2 Ω for a 50 Ω input impedance.

The balanced input and output interfaces are converted to single ended with a pair of baluns (M/A-COM ETC1-1-13). The balun at the input, T1, provides a 50 Ω single-ended-to-differential transformation. The output balun, T2, and the matching components are configured to provide a 200 Ω to 50 Ω impedance transformation with an insertion loss of about 17 dB.

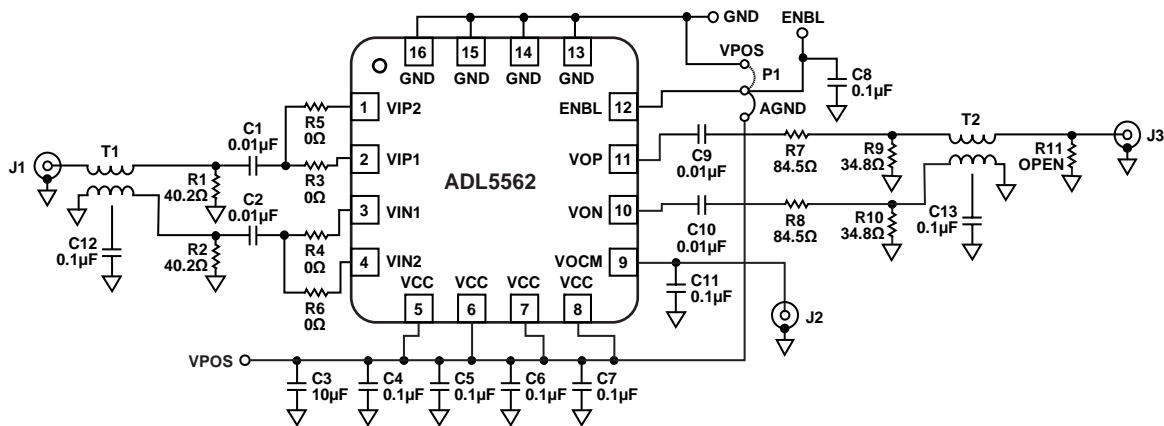
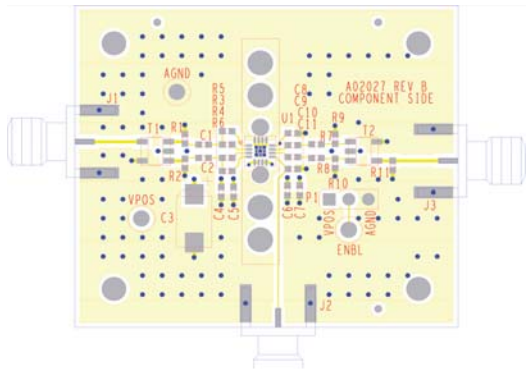

Figure 45. Evaluation Board Schematic

Table 14. Evaluation Board Configuration Options

| Component | Description | Default Condition |
|---|--|---|
| VPOS, GND | Ground and supply vector pins. | VPOS, GND = installed |
| C3, C4, C5, C6, C7, C11 | Power supply decoupling. The supply decoupling consists of a 10 μ F capacitor (C3) to ground. C4 to C7 are bypass capacitors. C11 ac couples VREF to ground. | C3 = 10 μ F (Size D), C4, C5, C6, C7, C11 = 0.1 μ F (Size 0402) |
| J1, R1, R2, R3, R4, R5, R6, C1, C2, C12, T1 | Input interface. The SMA labeled J1 is the input. T1 is a 1-to-1 impedance ratio balun to transform a single-ended input into a balanced differential signal. C1 and C2 provide ac coupling. C12 is a bypass capacitor. R1 and R2 provide a differential 50 Ω input termination. R3 to R6 are used to select the input for the pin-strappable gain. Maximum gain: R3, R4, R5, R6 = 0 Ω ; and R1, R2 = 40.2 Ω . Middle gain: R5, R6 = 0 Ω ; and R3, R4 = open; R1, R2 = 33 Ω . Minimum gain: R3, R4 = 0 Ω ; and R5, R6 = open; R1, R2 = 29 Ω . | J1 = installed, R1, R2 = 40.2 Ω (Size 0402), R3, R4, R5, R6 = 0 Ω (Size 0402), C1, C2 = 0.01 μ F (Size 0402), C12 = 0.1 μ F (Size 0402) T1 = ETC1-1-13 (M/A-COM) |
| J3, R7, R8, R9, R10, R11, C9, C10, C13, T2 | Output interface. The SMA labeled J3 is the output. T2 is a 1-to-1 impedance ratio balun to transform a balanced differential signal to a single-ended signal. C13 is a bypass capacitor. R7, R8, R9, and R10 are provided for generic placement of matching components. The evaluation board is configured to provide a 200 Ω to 50 Ω impedance transformation with an insertion loss of 17 dB. C9 and C10 provide ac coupling. | J3 = installed, R7, R8 = 84.5 Ω (Size 0402), R9, R10 = 34.8 Ω (Size 0402), R11 = open (Size 0402), C9, C10 = 0.01 μ F (Size 0402), C13 = 0.1 μ F (Size 0402) T2 = ETC1-1-13 (M/A-COM) |
| ENBL, P1, C8 | Device enable. C8 is a bypass capacitor. When the P1 jumper is set toward the VPOS label, the ENBL pin is connected to the supply, enabling the device. In the opposite direction, toward the GND label, the ENBL pin is grounded, putting the device in power-down mode. | ENBL, P1 = installed, C8 = 0.1 μ F (Size 0402) |



08003-041

Figure 46. Layout of Evaluation Board, Component Side

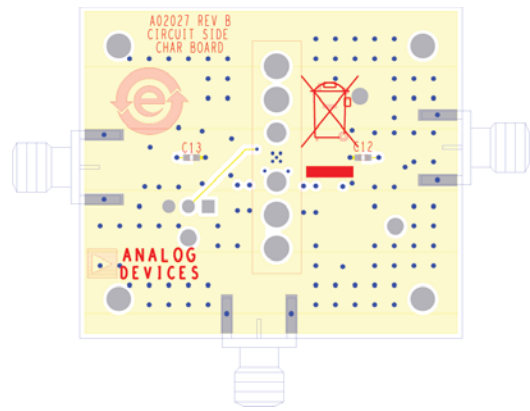

08003-042

Figure 47. Layout of Evaluation Board, Circuit Side

OUTLINE DIMENSIONS

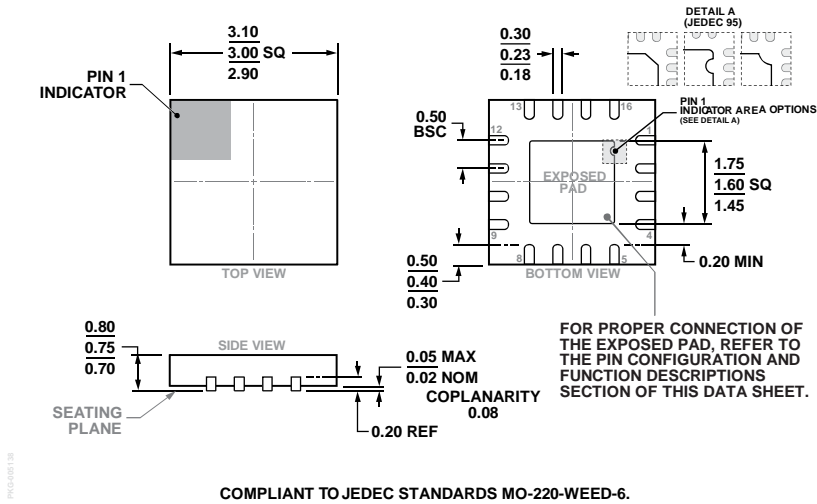

Figure 48. 16-Lead Lead Frame Chip Scale Package [LFCSP]
 3 mm × 3 mm Body and 0.75 mm Package Height
 (CP-16-22)
 Dimensions shown in millimeters

ORDERING GUIDE

| Model ¹ | Temperature Range | Package Description | Package Option | Branding | Ordering Quantity |
|--------------------|-------------------|---|----------------|----------|-------------------|
| ADL5562ACPZ-R7 | -40°C to +85°C | 16-Lead Lead Frame Chip Scale Package [LFCSP], 7" Tape and Reel | CP-16-22 | Q1Q | 1,500 |
| ADL5562ACPZ-WP | -40°C to +85°C | 16-Lead Lead Frame Chip Scale Package [LFCSP], Waffle Pack | CP-16-22 | Q1Q | 50 |
| ADL5562-EVALZ | | Evaluation Board | | | |

¹ Z = RoHS Compliant Part.

Mouser Electronics

Authorized Distributor

Click to View Pricing, Inventory, Delivery & Lifecycle Information:

[Analog Devices Inc.:](#)

[ADL5562ACPZ-R7](#) [AD5562ACPZ-R7](#) [ADL5562-EVALZ](#)