

TLE42744

Low Dropout Linear Voltage Regulator

TLE42744DV50
TLE42744GV50
TLE42744EV50
TLE42744GV33
TLE42744DV33
TLE42744GSV33

Data Sheet

Rev. 1.3, 2018-03-05

Automotive Power



1 Overview

Features

- Very Low Current Consumption
- Output Voltages 5 V and 3.3 V $\pm 2\%$
- Output Current up to 400 mA
- Very Low Dropout Voltage
- Output Current Limitation
- Reverse Polarity Protection
- Overtemperature Shutdown
- Wide Temperature Range
From $-40\text{ }^{\circ}\text{C}$ up to $150\text{ }^{\circ}\text{C}$
- Green Product (RoHS compliant)
- AEC Qualified

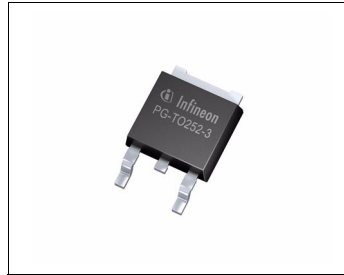

PG-TO252-3

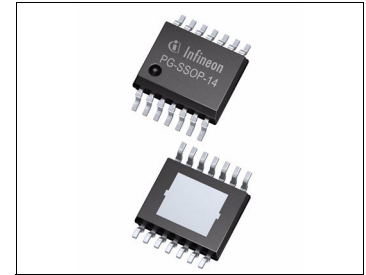

PG-SSOP-14 exposed pad



PG-TO263-3

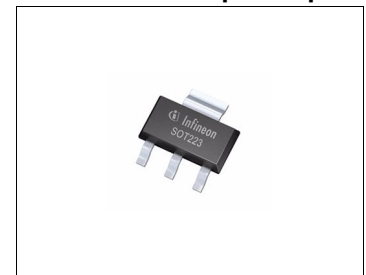

PG-SOT223-4

Description

The TLE42744 is a monolithic integrated low dropout voltage regulator for load currents up to 400 mA. An input voltage up to 40 V is regulated to $V_{Q,nom} = 5\text{ V} / 3.3\text{ V}$ with a precision of $\pm 2\%$. The device is designed for the harsh environment of automotive applications. Therefore it is protected against overload, short circuit and overtemperature conditions by the implemented output current limitation and the overtemperature shutdown circuit. The TLE42744 can be also used in all other applications requiring a stabilized 5 V / 3.3 V voltage.

Due to its very low quiescent current the TLE42744 is dedicated for use in applications permanently connected to V_{BAT} .

Type	Package	Marking
TLE42744DV50	PG-TO252-3	42744V5
TLE42744GV50	PG-TO263-3	42744V5
TLE42744EV50	PG-SSOP-14 exposed pad	42744V5
TLE42744DV33	PG-TO252-3	4274433
TLE42744GV33	PG-TO263-3	42744V33
TLE42744GSV33	PG-SOT223-4	427443

2 Block Diagram

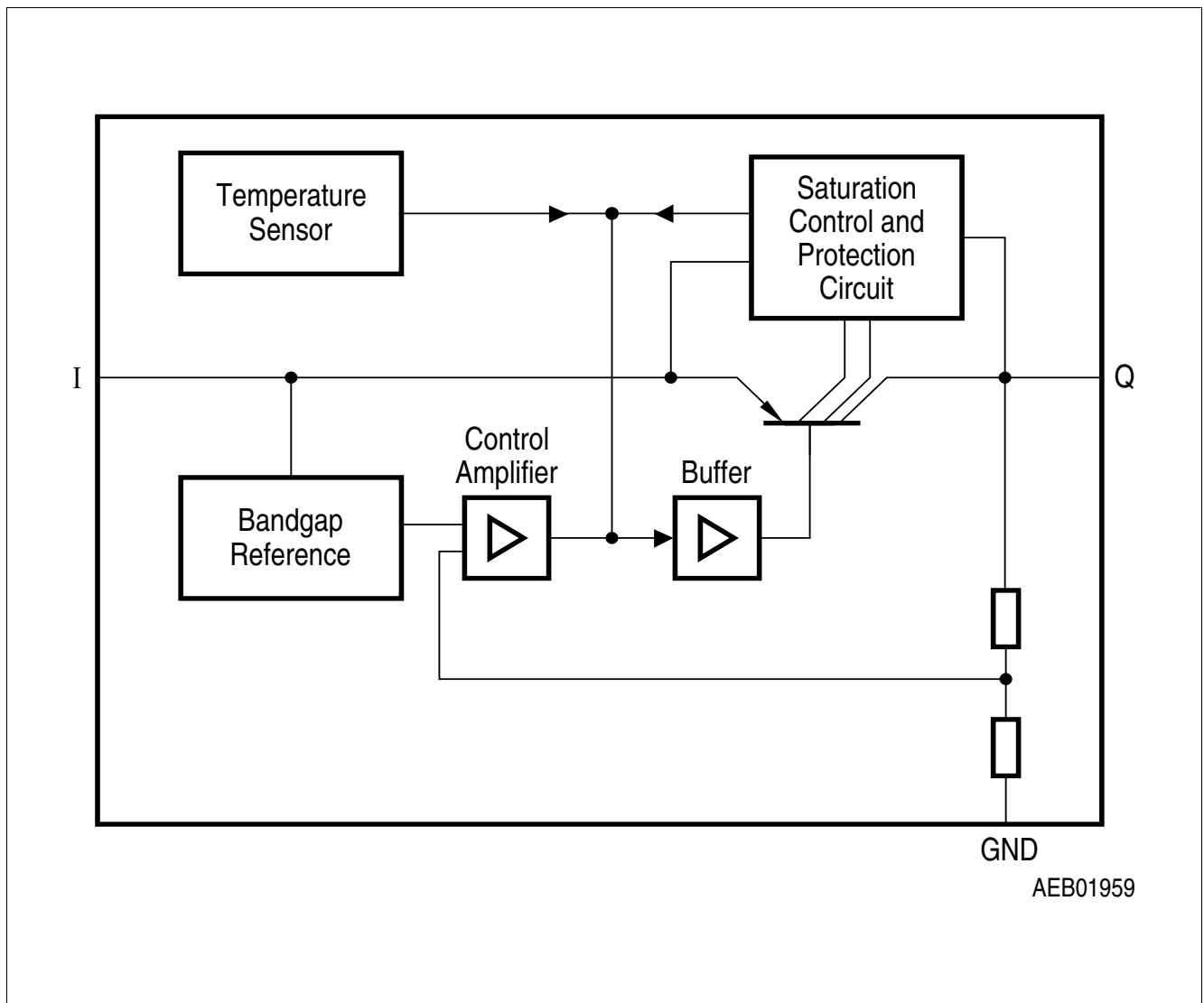

Figure 1 Block Diagram

3 Pin Configuration

3.1 Pin Assignment PG-TO252-3, PG-TO263-3 and PG-SOT223-4

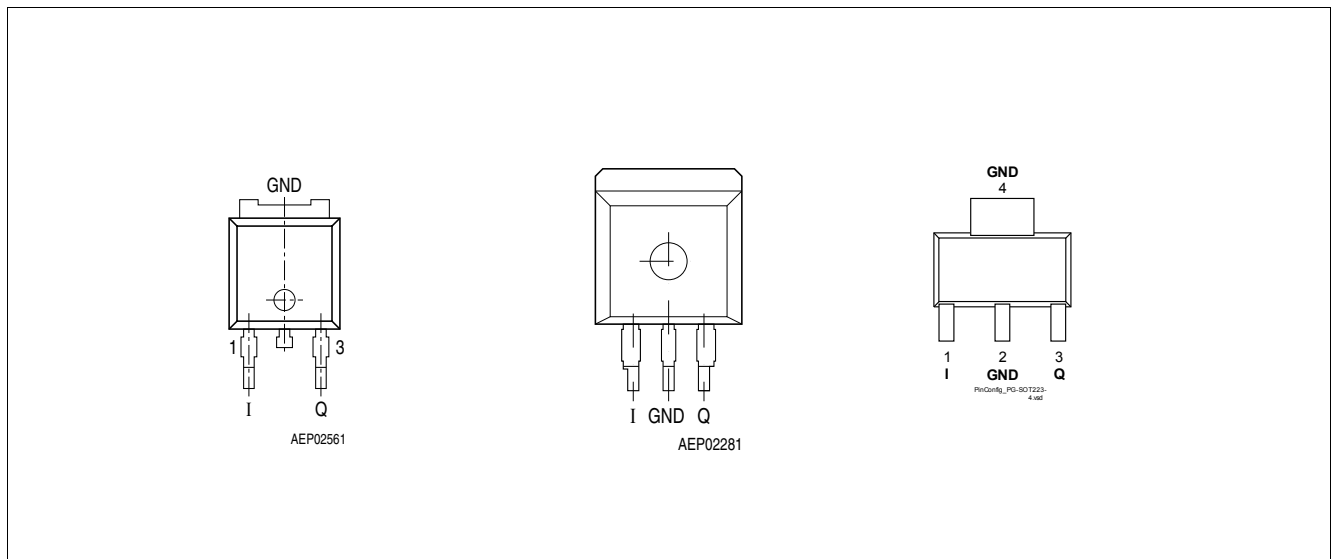

Figure 2 Pin Configuration (top view)

3.2 Pin Definitions and Functions PG-TO252-3, PG-TO263-3 and PG-SOT223-4

Pin No.	Symbol	Function
1	I	Input block to ground directly at the IC with a ceramic capacitor
2	GND	Ground internally connected to heat slug
3	Q	Output block to ground with a capacitor close to the IC terminals, respecting the values given for its capacitance and ESR in “Functional Range” on Page 6
4 / Heat Slug	–	Heat Slug internally connected to GND; connect to GND and heatsink area

3.3 Pin Assignment PG-SSOP-14 exposed pad

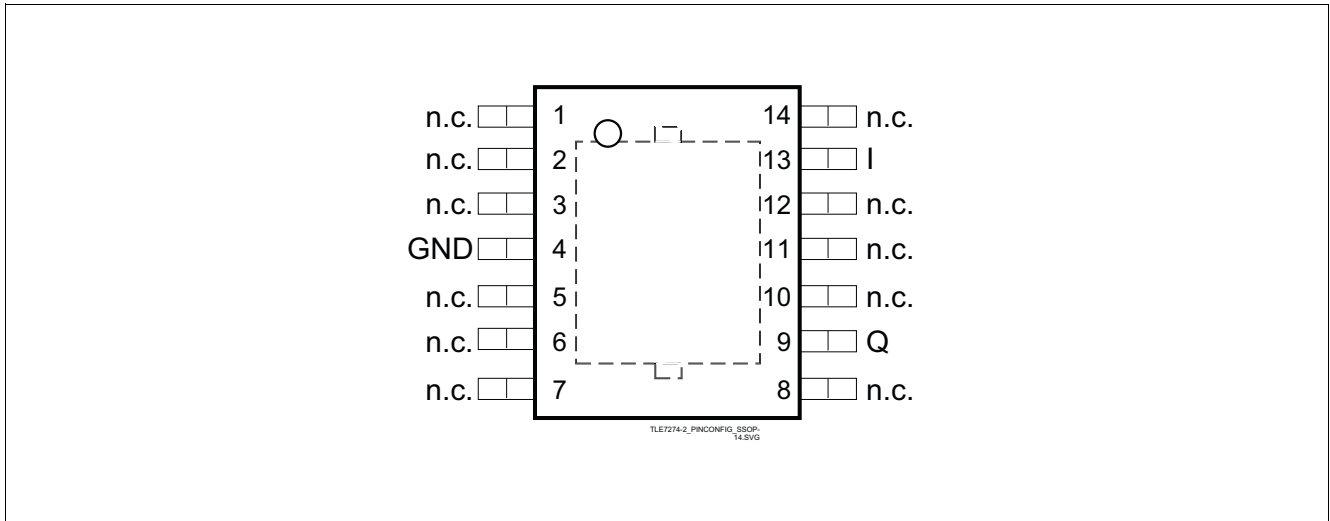

Figure 3 Pin Configuration (top view)

3.4 Pin Definitions and Functions PG-SSOP-14 exposed pad

Pin No.	Symbol	Function
1, 2, 3, 5, 6, 7	n.c.	Not connected can be open or connected to GND
4	GND	Ground
8, 10, 11, 12, 14	n.c.	Not connected can be open or connected to GND
9	Q	Output block to ground with a capacitor close to the IC terminals, respecting the values given for its capacitance and ESR in “Functional Range” on Page 6
13	I	Input block to ground directly at the IC with a ceramic capacitor
Pad	–	Exposed Pad connect to GND and heatsink area

4 General Product Characteristics

4.1 Absolute Maximum Ratings

Table 1 Absolute Maximum Ratings¹⁾

$T_j = -40\text{ °C to }150\text{ °C}$; all voltages with respect to ground, (unless otherwise specified)

Parameter	Symbol	Values			Unit	Note / Test Condition	Number
		Min.	Typ.	Max.			
Input I							
Voltage	V_I	-42	–	45	V	–	P_4.1.1
Output Q							
Voltage	V_Q	-1	–	40	V	–	P_4.1.2
Temperature							
Junction temperature	T_j	-40	–	150	°C	–	P_4.1.3
Storage temperature	T_{stg}	-50	–	150	°C	–	P_4.1.4
ESD Susceptibility							
ESD Absorption	$V_{ESD,HBM}$	-4	–	4	kV	Human Body Model (HBM) ²⁾	P_4.1.5
ESD Absorption	$V_{ESD,CDM}$	-1000	–	1000	V	Charge Device Model (CDM) ³⁾ at all pins	P_4.1.6

1) not subject to production test, specified by design

2) ESD susceptibility Human Body Model “HBM” according to AEC-Q100-002 - JESD22-A114

3) ESD susceptibility Charged Device Model “CDM” according to ESDA STM5.3.1

Notes

1. Stresses above the ones listed here may cause permanent damage to the device. Exposure to absolute maximum rating conditions for extended periods may affect device reliability.
2. Integrated protection functions are designed to prevent IC destruction under fault conditions described in the data sheet. Fault conditions are considered as “outside” normal operating range. Protection functions are not designed for continuous repetitive operation.

4.2 Functional Range

Table 2 Functional Range

Parameter	Symbol	Values			Unit	Note / Test Condition	Number
		Min.	Typ.	Max.			
Input voltage	V_I	5.5	–	40	V	TLE42744DV50, TLE42744GV50, TLE42744EV50	P_4.2.1
Input voltage	V_I	4.7	–	40	V	TLE42744GV33, TLE42744DV33, TLE42744GSV33	P_4.2.2

Table 2 Functional Range (cont'd)

Parameter	Symbol	Values			Unit	Note / Test Condition	Number
		Min.	Typ.	Max.			
Output Capacitor's Requirements for Stability	C_Q	22		–	μF	¹⁾	P_4.2.3
Output Capacitor's Requirements for Stability	$ESR(C_Q)$	–		3	Ω	²⁾	P_4.2.4
Junction temperature	T_j	-40		150	$^{\circ}\text{C}$	–	P_4.2.5

1) the minimum output capacitance requirement is applicable for a worst case capacitance tolerance of 30%

2) relevant ESR value at $f = 10$ kHz

Note: Within the functional or operating range, the IC operates as described in the circuit description. The electrical characteristics are specified within the conditions given in the Electrical Characteristics table.

4.3 Thermal Resistance

Note: This thermal data was generated in accordance with JEDEC JESD51 standards. For more information, go to www.jedec.org.

Table 3 Thermal Resistance

Parameter	Symbol	Values			Unit	Note / Test Condition	Number
		Min.	Typ.	Max.			
TLE42744DV50, TLE42744DV33 (PG-TO252-3)							
Junction to Case ¹⁾	R_{thJC}	–	3.6	–	K/W	measured to heat slug	P_4.3.1
Junction to Ambient ¹⁾	R_{thJA}	–	27	–	K/W	FR4 2s2p board ²⁾	P_4.3.2
Junction to Ambient ¹⁾	R_{thJA}	–	115	–	K/W	FR4 1s0p board, footprint only ³⁾	P_4.3.3
Junction to Ambient ¹⁾	R_{thJA}	–	52	–	K/W	FR4 1s0p board, 300 mm ² heatsink area ³⁾	P_4.3.4
Junction to Ambient ¹⁾	R_{thJA}	–	40	–	K/W	FR4 1s0p board, 600 mm ² heatsink area ³⁾	P_4.3.5
TLE42744GV50, TLE42744GV33 (PG-TO263-3)							
Junction to Case ¹⁾	R_{thJC}	–	3.6	–	K/W	measured to heat slug	P_4.3.6
Junction to Ambient ¹⁾	R_{thJA}	–	22	–	K/W	FR4 2s2p board ²⁾	P_4.3.7
Junction to Ambient ¹⁾	R_{thJA}	–	74	–	K/W	FR4 1s0p board, footprint only ³⁾	P_4.3.8
Junction to Ambient ¹⁾	R_{thJA}	–	42	–	K/W	FR4 1s0p board, 300 mm ² heatsink area ³⁾	P_4.3.9
Junction to Ambient ¹⁾	R_{thJA}	–	34	–	K/W	FR4 1s0p board, 600 mm ² heatsink area ³⁾	P_4.3.10

Table 3 Thermal Resistance (cont'd)

Parameter	Symbol	Values			Unit	Note / Test Condition	Number
		Min.	Typ.	Max.			
TLE42744EV50 (PG-SSOP-14 exposed pad)							
Junction to Case ¹⁾	R_{thJC}	–	7	–	K/W	measured to exposed pad	P_4.3.11
Junction to Ambient ¹⁾	R_{thJA}	–	43	–	K/W	FR4 2s2p board ²⁾	P_4.3.12
Junction to Ambient ¹⁾	R_{thJA}	–	120	–	K/W	FR4 1s0p board, footprint only ³⁾	P_4.3.13
Junction to Ambient ¹⁾	R_{thJA}	–	59	–	K/W	FR4 1s0p board, 300 mm ² heatsink area ³⁾	P_4.3.14
Junction to Ambient ¹⁾	R_{thJA}	–	49	–	K/W	FR4 1s0p board, 600 mm ² heatsink area ³⁾	P_4.3.15
TLE42744GSV33 (PG-SOT223-4)							
Junction to Case ¹⁾	R_{thJC}	–	17	–	K/W	measured to heat slug	P_4.3.16
Junction to Ambient ¹⁾	R_{thJA}	–	54	–	K/W	FR4 2s2p board ²⁾	P_4.3.17
Junction to Ambient ¹⁾	R_{thJA}	–	139	–	K/W	FR4 1s0p board, footprint only ³⁾	P_4.3.18
Junction to Ambient ¹⁾	R_{thJA}	–	73	–	K/W	FR4 1s0p board, 300 mm ² heatsink area ³⁾	P_4.3.19
Junction to Ambient ¹⁾	R_{thJA}	–	64	–	K/W	FR4 1s0p board, 600 mm ² heatsink area ³⁾	P_4.3.20

1) Not subject to production test, specified by design.

2) Specified R_{thJA} value is according to Jedec JESD51-2,-5,-7 at natural convection on FR4 2s2p board; The Product (Chip+Package) was simulated on a 76.2 x 114.3 x 1.5 mm³ board with 2 inner copper layers (2 x 70µm Cu, 2 x 35µm Cu). Where applicable a thermal via array under the exposed pad contacted the first inner copper layer.

3) Specified R_{thJA} value is according to Jedec JESD 51-3 at natural convection on FR4 1s0p board; The Product (Chip+Package) was simulated on a 76.2 x 114.3 x 1.5 mm³ board with 1 copper layer (1 x 70µm Cu).

5 Electrical Characteristics

5.1 Electrical Characteristics Voltage Regulator

Table 4 Electrical Characteristics
 $V_I = 13.5 \text{ V}$; $T_j = -40 \text{ }^\circ\text{C}$ to $150 \text{ }^\circ\text{C}$; all voltages with respect to ground (unless otherwise specified)

Parameter	Symbol	Values			Unit	Note / Test Condition	Number
		Min.	Typ.	Max.			
Output Q							
Output Voltage	V_Q	4.9	5.0	5.1	V	TLE42744DV50, TLE42744GV50, TLE42744EV50 $5 \text{ mA} < I_Q < 400 \text{ mA}$ $6 \text{ V} < V_I < 28 \text{ V}$	P_5.1.1
Output Voltage	V_Q	4.9	5.0	5.1	V	TLE42744DV50, TLE42744GV50, TLE42744EV50 $5 \text{ mA} < I_Q < 200 \text{ mA}$ $6 \text{ V} < V_I < 40 \text{ V}$	P_5.1.2
Output Voltage	V_Q	3.23	3.3	3.37	V	TLE42744GV33, TLE42744DV33, TLE42744GSV33; $5 \text{ mA} < I_Q < 400 \text{ mA}$ $4.7 \text{ V} < V_I < 28 \text{ V}$	P_5.1.3
Output Voltage	V_Q	3.23	3.3	3.37	V	TLE42744GV33, TLE42744DV33, TLE42744GSV33; $5 \text{ mA} < I_Q < 200 \text{ mA}$ $4.7 \text{ V} < V_I < 40 \text{ V}$	P_5.1.4
Dropout Voltage	V_{dr}	–	250	500	mV	TLE42744DV50, TLE42744GV50, TLE42744EV50 $I_Q = 250 \text{ mA}$ $V_{dr} = V_I - V_Q^{1)}$	P_5.1.5
Load Regulation	$\Delta V_{Q, lo}$	–	20	50	mV	TLE42744DV50, TLE42744GV50, TLE42744EV50; $I_Q = 5 \text{ mA}$ to 400 mA $V_I = 6 \text{ V}$	P_5.1.6
Load Regulation	$\Delta V_{Q, lo}$	–	40	70	mV	TLE42744GV33, TLE42744DV33, TLE42744GSV33; $I_Q = 5 \text{ mA}$ to 300 mA	P_5.1.7
Line Regulation	$\Delta V_{Q, li}$	–	10	25	mV	$V_I = 12 \text{ V}$ to 32 V $I_Q = 5 \text{ mA}$	P_5.1.8

Table 4 Electrical Characteristics (cont'd)
 $V_I = 13.5\text{ V}$; $T_j = -40\text{ °C}$ to 150 °C ; all voltages with respect to ground (unless otherwise specified)

Parameter	Symbol	Values			Unit	Note / Test Condition	Number
		Min.	Typ.	Max.			
Output Current Limitation	I_Q	400	600	1100	mA	¹⁾	P_5.1.9
Power Supply Ripple Rejection ²⁾	$PSRR$	–	60	–	dB	$f_r = 100\text{ Hz}$; $V_r = 0.5\text{ Vpp}$	P_5.1.10
Temperature Output Voltage Drift	$\frac{dV_Q}{dT}$	–	0.5	–	mV/K	–	P_5.1.11
Overtemperature Shutdown Threshold	$T_{j,sd}$	151	–	200	°C	T_j increasing ²⁾	P_5.1.12
Overtemperature Shutdown Threshold Hysteresis	$T_{j,sdh}$	–	25	–	°C	T_j decreasing ²⁾	P_5.1.13
Current Consumption							
Quiescent Current $I_q = I_I - I_Q$	I_q	–	100	220	μA	$I_Q = 1\text{ mA}$	P_5.1.14
Current Consumption $I_q = I_I - I_Q$	I_q	–	8	15	mA	$I_Q = 250\text{ mA}$	P_5.1.15
Current Consumption $I_q = I_I - I_Q$	I_q	–	15	25	mA	TLE42744DV50, TLE42744GV50, TLE42744EV50; $I_Q = 400\text{ mA}$	P_5.1.16
Current Consumption $I_q = I_I - I_Q$	I_q	–	20	30	mA	TLE42744GV33, TLE42744DV33, TLE42744GSV33; $I_Q = 400\text{ mA}$	P_5.1.17

1) Measured when the output voltage V_Q has dropped 100 mV from the nominal value obtained at $V_I = 13.5\text{ V}$.

2) not subject to production test, specified by design

5.2 Typical Performance Characteristics Voltage Regulator

Current Consumption I_q versus Output Current I_Q

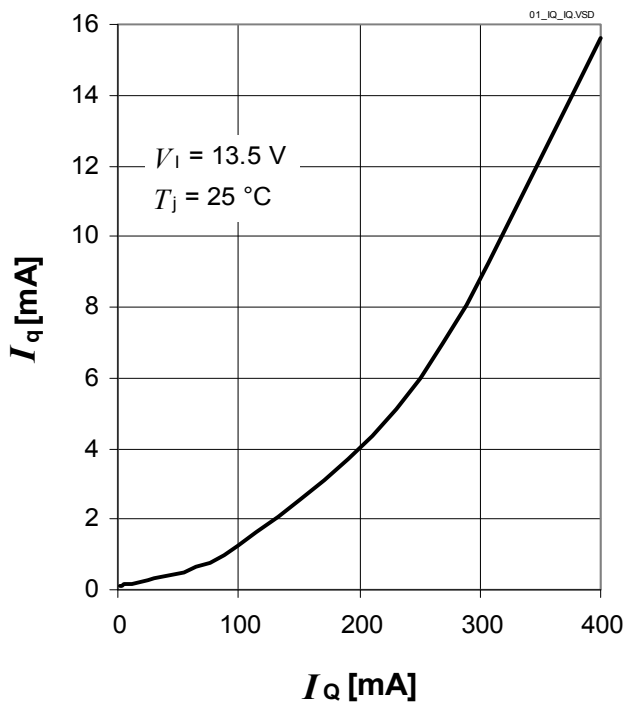

Current Consumption I_q versus Low Output Current I_Q

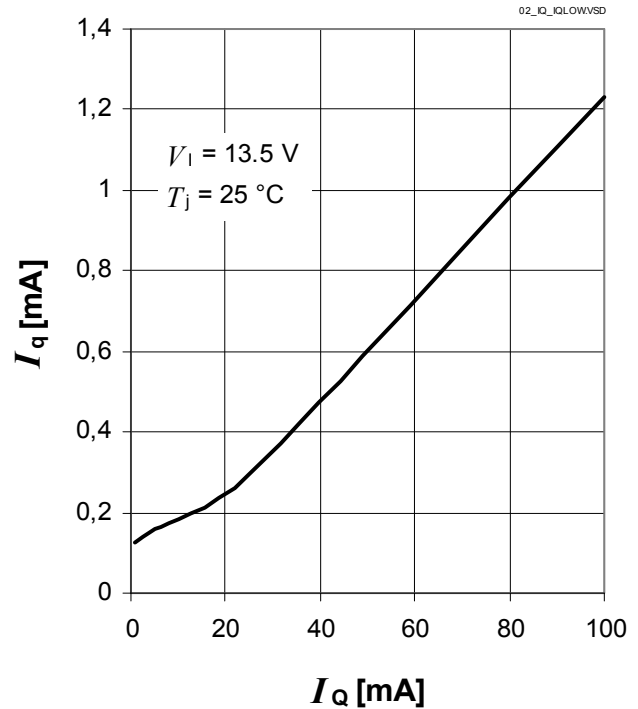

Output Voltage Variation ΔV_Q versus Junction Temperature T_j

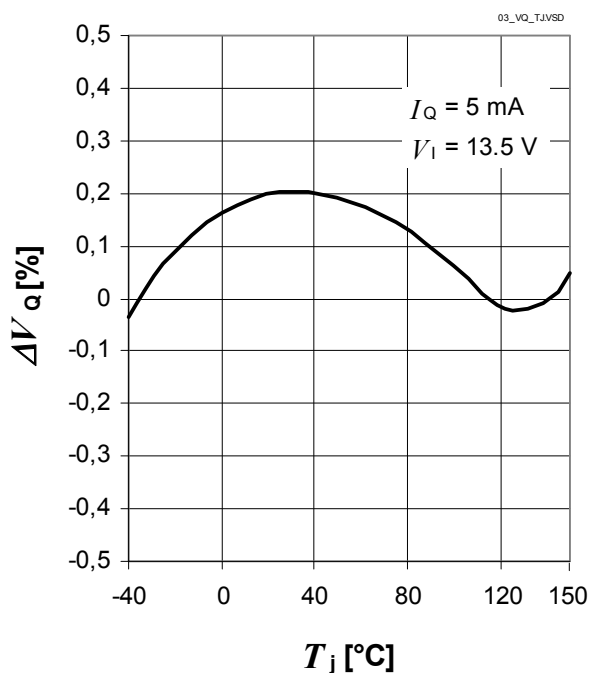

Dropout Voltage V_{dr} versus Output Current I_Q (5 V versions only)

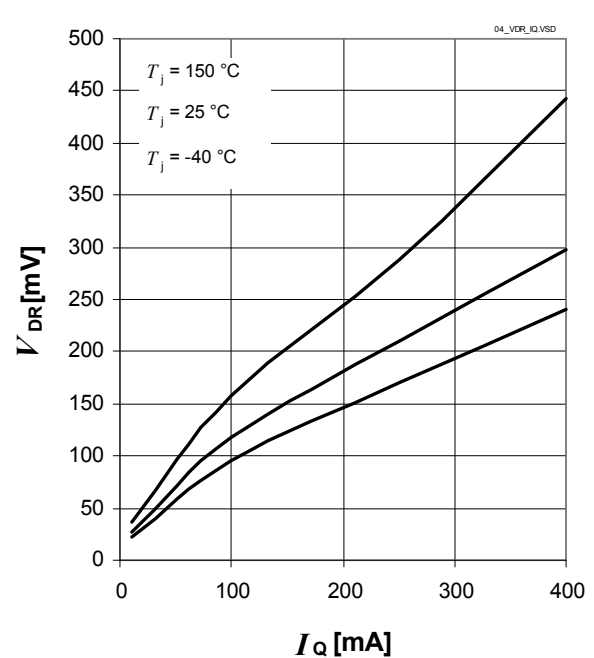

Dropout Voltage V_{dr} versus Junction Temperature (5 V versions only)

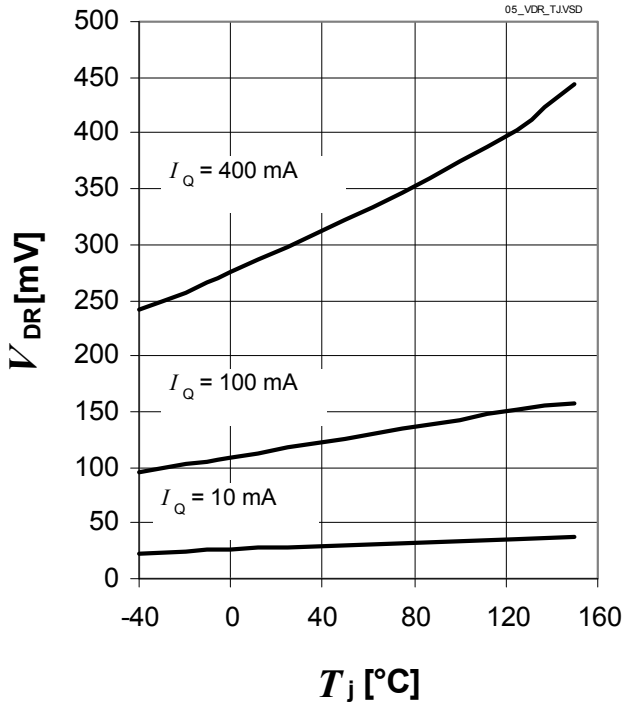

Maximum Output Current I_Q versus Input Voltage V_I

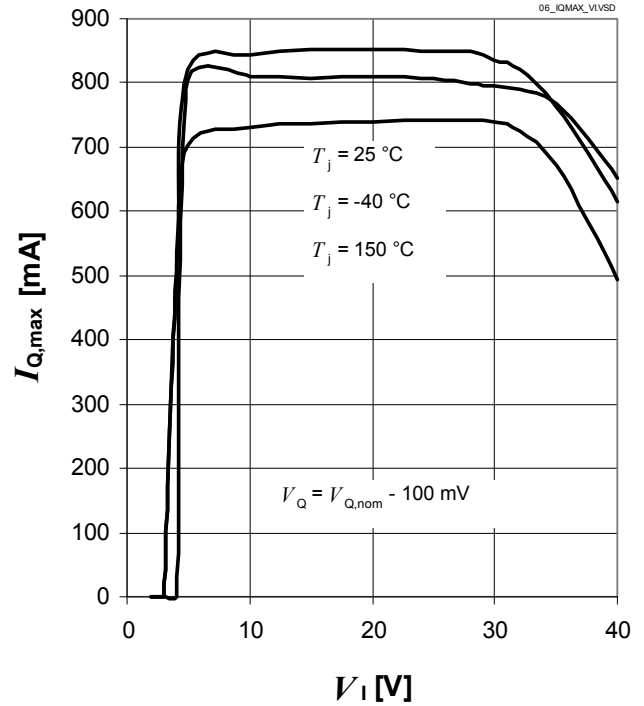

Region Of Stability: Output Capacitor's ESR $ESR(C_Q)$ versus Output Current I_Q

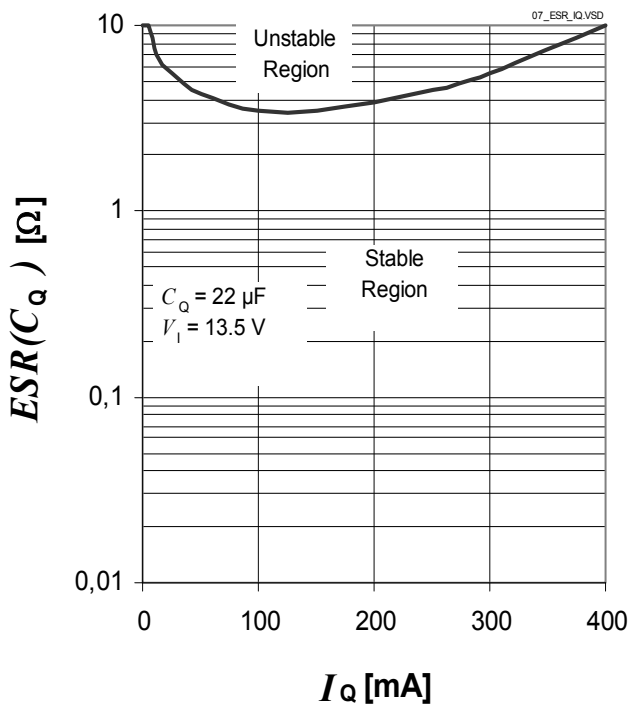

6 Application Information

Note: The following information is given as a hint for the implementation of the device only and shall not be regarded as a description or warranty of a certain functionality, condition or quality of the device.

6.1 Application Diagram

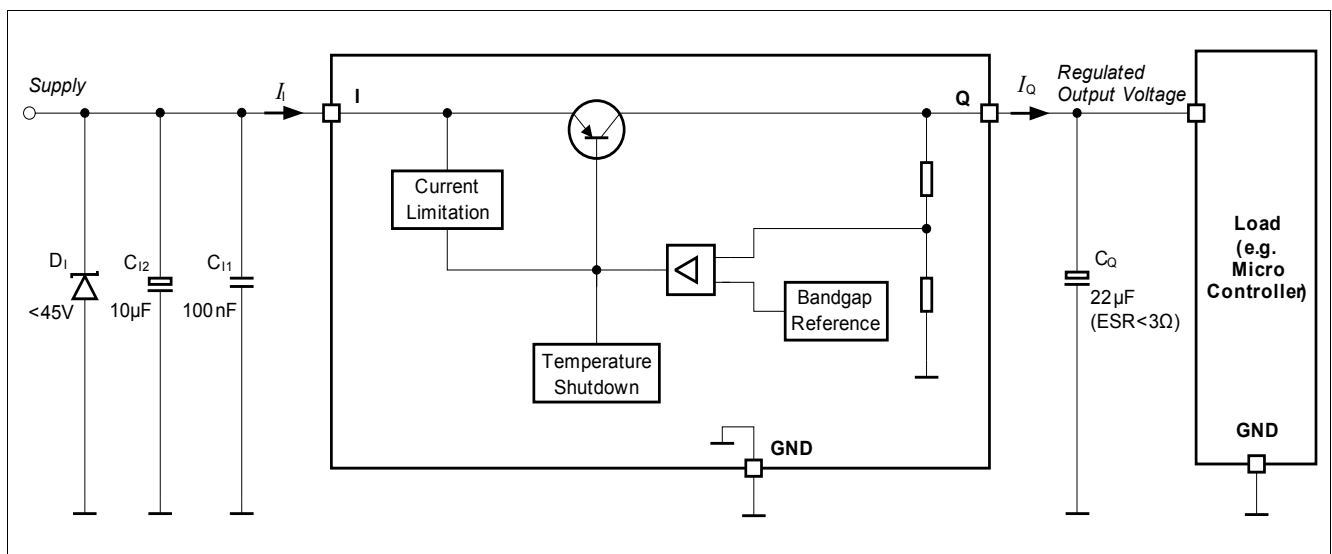

Figure 4 Application Diagram

6.2 Selection of External Components

6.2.1 Input Pin

The typical input circuitry for a linear voltage regulator is shown in the application diagram above.

A ceramic capacitor at the input, in the range of 100 nF to 470 nF, is recommended to filter out the high frequency disturbances imposed by the line e.g. ISO pulses 3a/b. This capacitor must be placed very close to the input pin of the linear voltage regulator on the PCB.

An aluminum electrolytic capacitor in the range of 10 µF to 470 µF is recommended as an input buffer to smooth out high energy pulses, such as ISO pulse 2a. This capacitor should be placed close to the input pin of the linear voltage regulator on the PCB.

An overvoltage suppressor diode can be used to further suppress any high voltage beyond the maximum rating of the linear voltage regulator and protect the device against any damage due to over-voltage.

The external components at the input are not mandatory for the operation of the voltage regulator, but they are recommended in case of possible external disturbances.

6.2.2 Output Pin

An output capacitor is mandatory for the stability of linear voltage regulators.

The requirement to the output capacitor is given in **“Functional Range” on Page 6**. The graph **“Region Of Stability: Output Capacitor’s ESR ESR(CQ) versus Output Current IQ” on Page 12** shows the stable operation range of the device.

TLE42744 is designed to be stable with extremely low ESR capacitors. According to the automotive environment, ceramic capacitors with X5R or X7R dielectrics are recommended.

The output capacitor should be placed as close as possible to the regulator's output and GND pins and on the same side of the PCB as the regulator itself.

In case of rapid transients of input voltage or load current, the capacitance should be dimensioned in accordance and verified in the real application that the output stability requirements are fulfilled.

6.3 Thermal Considerations

Knowing the input voltage, the output voltage and the load profile of the application, the total power dissipation can be calculated:

$$P_D = (V_I - V_Q) \times I_Q + V_I \times I_q \quad (1)$$

with

- P_D : continuous power dissipation
- V_I : input voltage
- V_Q : output voltage
- I_Q : output current
- I_q : quiescent current

The maximum acceptable thermal resistance R_{thJA} can then be calculated:

$$R_{thJA, max} = \frac{T_{j, max} - T_a}{P_D} \quad (2)$$

with

- $T_{j, max}$: maximum allowed junction temperature
- T_a : ambient temperature

Based on the above calculation the proper PCB type and the necessary heat sink area can be determined with reference to the specification in **[“Thermal Resistance” on Page 7.](#)**

Example

Application conditions:

$$V_I = 13.5 \text{ V}$$

$$V_Q = 5 \text{ V}$$

$$I_Q = 250 \text{ mA}$$

$$T_a = 85 \text{ °C}$$

Calculation of $R_{thJA, max}$:

$$\begin{aligned} P_D &= (V_I - V_Q) \cdot I_Q + V_I \cdot I_q \\ &= (13.5 \text{ V} - 5 \text{ V}) \cdot 250 \text{ mA} + 13.5 \text{ V} \cdot 15 \text{ mA} \\ &= 2.125 \text{ W} + 0.2025 \text{ W} \\ &= 2.3275 \text{ W} \end{aligned}$$

$$\begin{aligned} R_{\text{thJA,max}} &= (T_{\text{j,max}} - T_{\text{a}}) / P_{\text{D}} \\ &= (150 \text{ }^{\circ}\text{C} - 85 \text{ }^{\circ}\text{C}) / 2.3275 \text{ W} \\ &= 27.93 \text{ K/W} \end{aligned}$$

As a result, the PCB design must ensure a thermal resistance R_{thJA} lower than 27.93 K/W. By considering TLE42744GV50 (PG-TO263-3 package) and according to **“Thermal Resistance” on Page 7**, only the FR4 2s2p board is applicable.

6.4 Reverse Polarity Protection

TLE42744 is self protected against reverse polarity faults and allows negative supply voltage. External reverse polarity diode is not needed. However, the absolute maximum ratings of the device as specified in **“Absolute Maximum Ratings” on Page 6** must be kept.

The reverse voltage causes several small currents to flow into the IC hence increasing its junction temperature. As the thermal shut down circuitry does not work in the reverse polarity condition, designers have to consider this in their thermal design.

7 Package Outlines

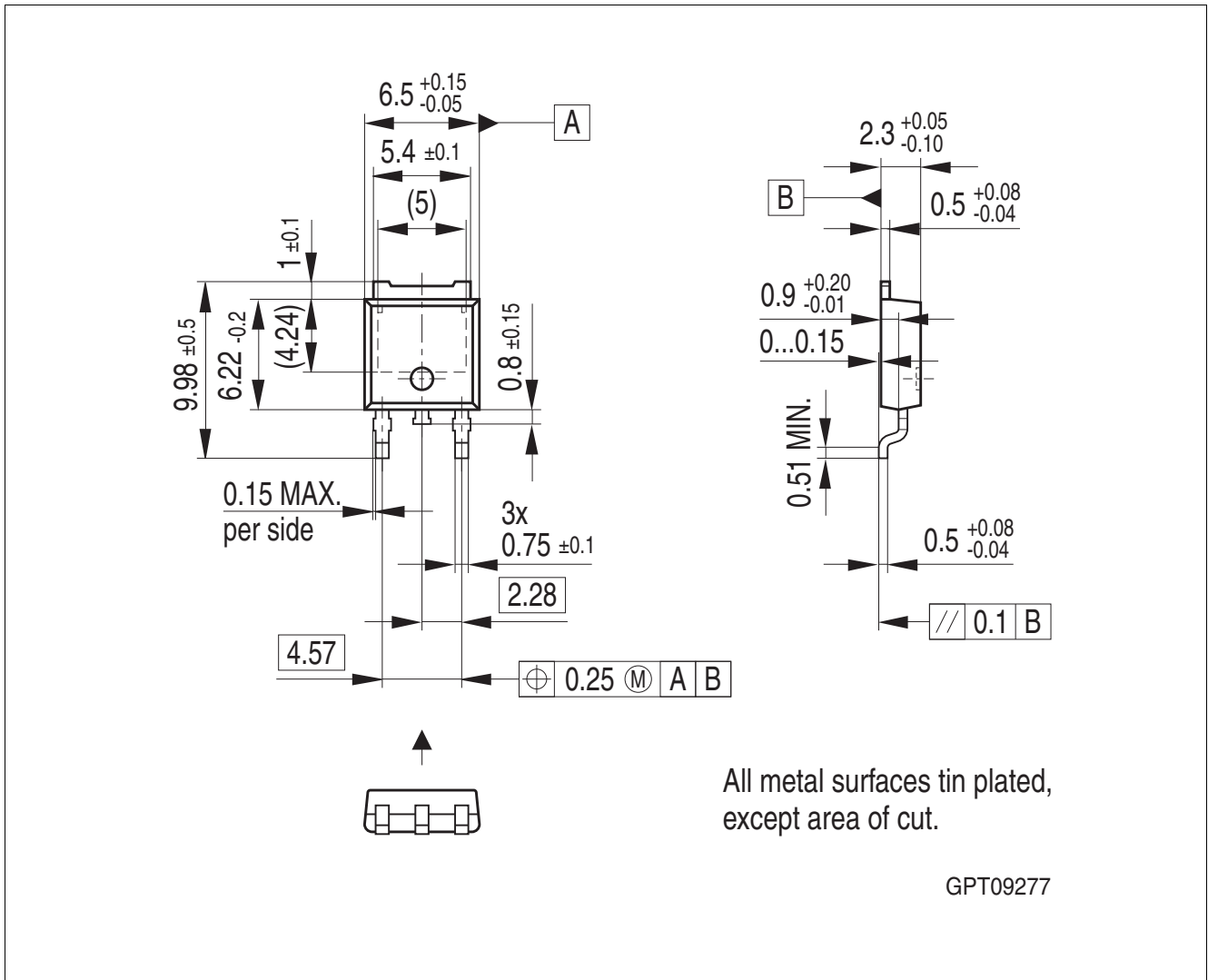

Figure 5 PG-T0252-3

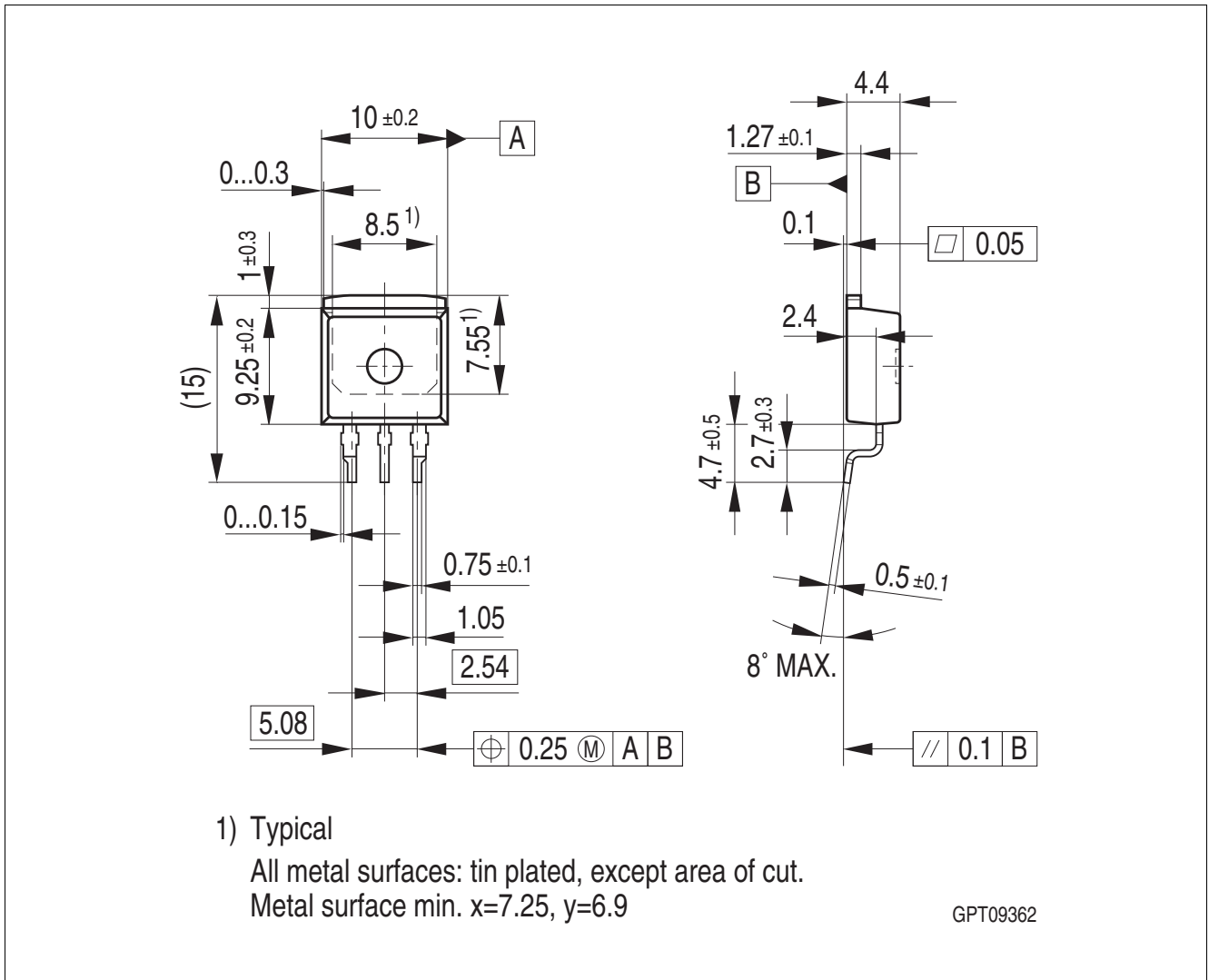

Figure 6 PG-TO263-3

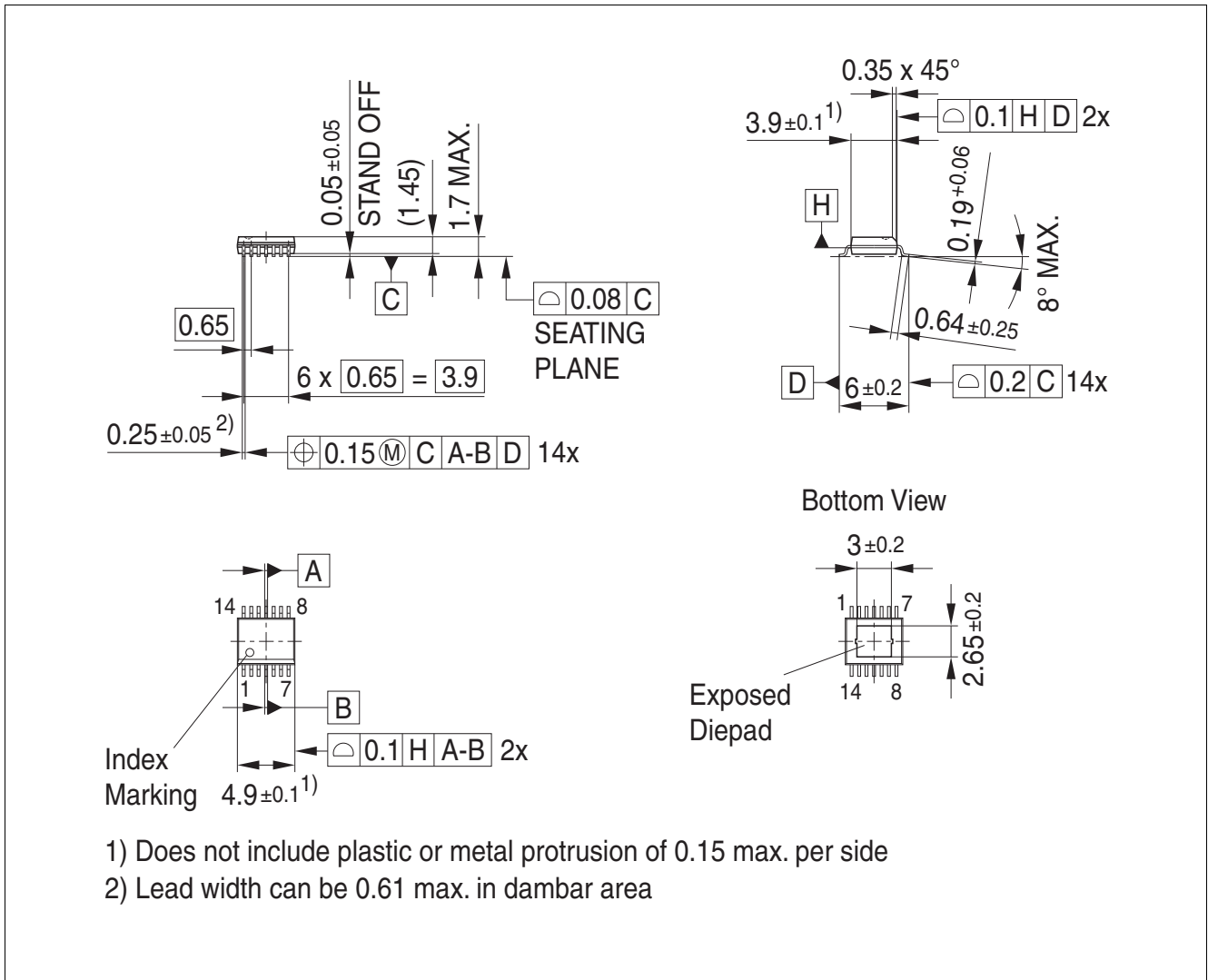

Figure 7 PG-SSOP-14 exposed pad

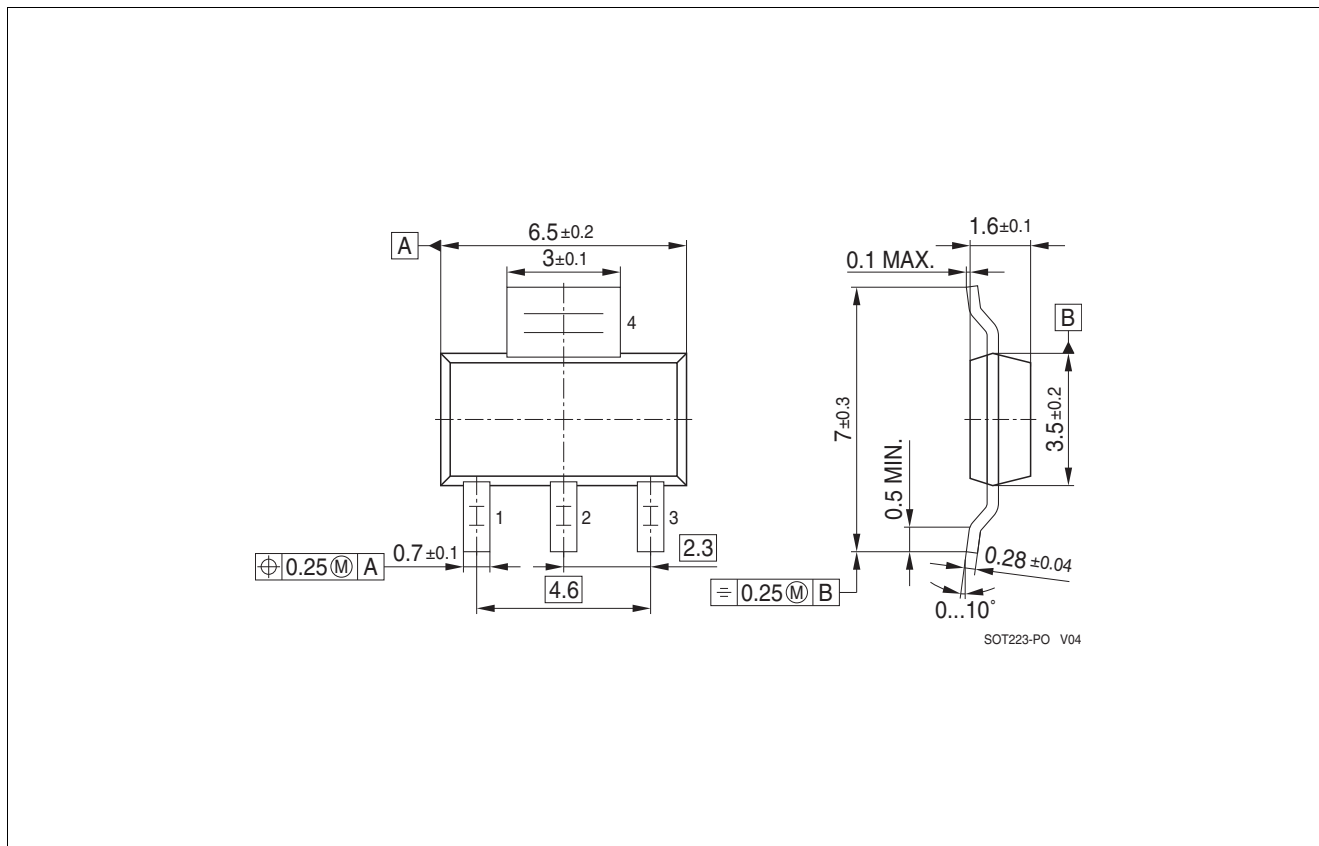

Figure 8 PG-SOT223-4

Green Product (RoHS compliant)

To meet the world-wide customer requirements for environmentally friendly products and to be compliant with government regulations the device is available as a green product. Green products are RoHS-Compliant (i.e Pb-free finish on leads and suitable for Pb-free soldering according to IPC/JEDEC J-STD-020).

8 Revision History

Revision	Date	Changes
1.3	2018-03-05	Marking update in Chapter Overview (TLE42744GSV33 and TLE42744DV33) Updated Template on the last page.
1.2	2014-07-03	Application Information added. PG-TO252-3 and PG-SSOP-14 EP package outlines updated.
1.1	2010-01-13	Updated Version Data Sheet: version TLE42744EV50 in PG-SSOP-14 exposed pad and all related description added; 3.3V versions TLE42744GV33 in PG-TO263-3, TLE42744DV33 in PG-TO252-3 and TLE42744GSV33 in PG-SOT223-4 and all related description added
1.0	2009-01-14	Initial Version final Data Sheet

Trademarks

All referenced product or service names and trademarks are the property of their respective owners.

Edition 2018-03-05

Published by

Infineon Technologies AG

81726 Munich, Germany

© 2018 Infineon Technologies AG.

All Rights Reserved.

Do you have a question about any aspect of this document?

Email: erratum@infineon.com

IMPORTANT NOTICE

The information given in this document shall in no event be regarded as a guarantee of conditions or characteristics ("Beschaffenhheitsgarantie").

With respect to any examples, hints or any typical values stated herein and/or any information regarding the application of the product, Infineon Technologies hereby disclaims any and all warranties and liabilities of any kind, including without limitation warranties of non-infringement of intellectual property rights of any third party.

In addition, any information given in this document is subject to customer's compliance with its obligations stated in this document and any applicable legal requirements, norms and standards concerning customer's products and any use of the product of Infineon Technologies in customer's applications.

The data contained in this document is exclusively intended for technically trained staff. It is the responsibility of customer's technical departments to evaluate the suitability of the product for the intended application and the completeness of the product information given in this document with respect to such application.

For further information on technology, delivery terms and conditions and prices, please contact the nearest Infineon Technologies Office (www.infineon.com).

WARNINGS

Due to technical requirements products may contain dangerous substances. For information on the types in question please contact your nearest Infineon Technologies office.

Except as otherwise explicitly approved by Infineon Technologies in a written document signed by authorized representatives of Infineon Technologies, Infineon Technologies' products may not be used in any applications where a failure of the product or any consequences of the use thereof can reasonably be expected to result in personal injury.

Mouser Electronics

Authorized Distributor

Click to View Pricing, Inventory, Delivery & Lifecycle Information:

[Infineon:](#)

[TLE42744GSV33HUMA1](#) [TLE42744DV50ATMA1](#)