

# ALMD-CM1F/2F, ALMD-CB1E/2E



## High-Brightness SMT Round Green and Blue LED Lamps

### Data Sheet

---

#### Description

The Broadcom ALMD-Cx1x/Cx2x series is like a conventional high brightness through-hole LED in the form of surface mount device. It can be assembled using common SMT assembly processes and is compatible with industrial reflow soldering processes.

The LEDs are made with an advanced optical grade epoxy for superior performance in outdoor sign applications. For easy pick-and-place assembly, the LEDs are shipped in tape and reel. Every reel is shipped from a single intensity and color bin for better uniformity.

#### Features

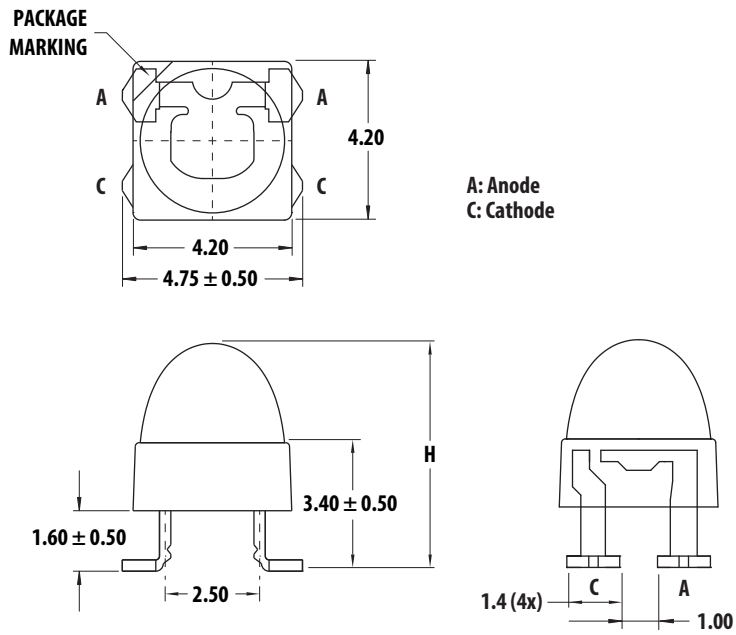
- Using high brightness InGaN
- Available green and blue
  - Green InGaN 525 nm
  - Blue InGaN 470 nm
- Typical viewing angle: 15° and 23°
- JEDEC MSL 2A
- Compatible with a reflow soldering process
- Tinted

#### Applications

- Variable message signs

**CAUTION:** The LEDs are ESD sensitive per ANSI/ESDA/JEDEC JS-001. Please observe appropriate precautions during handling and processing. Refer to Application Note AN-1142 for additional details.

**CAUTION:** Customers should always keep the LED in the moisture barrier bag (MBB) with < 5% RH when not in use because prolonged exposure to the environment might cause the silver-plated leads to tarnish or rust, which might cause difficulties in soldering.

**Figure 1 Package Dimensions**

Part Number	Dimension H
ALMD-Cx1x	6.80 ± 0.50
ALMD-Cx2x	6.50 ± 0.50

**NOTE**

1. All dimensions are in millimeters (mm).
2. Tolerance is  $\pm 0.20$  mm unless otherwise specified.
3. Midsteel lead frame.

## Device Selection Guide

Part Number	Color	Dominant Wavelength, $\lambda_d$ (nm) <sup>a</sup>	Luminous Intensity, $I_v$ (mcd) <sup>b,c,d</sup>		Viewing Angle, $2\theta_{1/2}$ (°) <sup>e</sup>
		Typ.	Min.	Max.	Typ.
ALMD-CM1F-34002	Green	525	27000	45000	15
ALMD-CM1F-34B02					
ALMD-CM1F-34C02					
ALMD-CB1E-VW002	Blue	470	4200	7200	
ALMD-CB1E-VWB02					
ALMD-CB1E-VWC02					
ALMD-CM2F-12002	Green	525	16000	27000	23
ALMD-CM2F-12B02					
ALMD-CM2F-12C02					
ALMD-CB2E-UV002	Blue	470	3200	5500	
ALMD-CB2E-UVB02					
ALMD-CB2E-UVC02					

- Dominant wavelength,  $\lambda_d$ , is derived from the CIE Chromaticity Diagram and represents the color of the lamp.
- The luminous intensity is measured on the mechanical axis of the lamp package and it is tested with pulsing condition.
- The optical axis is closely aligned with the package mechanical axis.
- Tolerance for each bin limit is  $\pm 15\%$ .
- $\theta_{1/2}$  is the off-axis angle where the luminous intensity is half of the peak intensity.

## Absolute Maximum Rating, $T_j = 25^\circ\text{C}$

Parameter	Green	Blue	Unit
DC Forward Current <sup>a</sup>	30	20	mA
Peak Forward Current <sup>b</sup>	100	100	mA
Power Dissipation	114	76	mW
Reverse Voltage	Not recommended for reverse bias		
LED Junction Temperature	110	105	°C
Operating Temperature Range	-40 to +85		°C
Storage Temperature Range	-40 to +100		°C

- Derate linearly as shown in [Figure 5](#).
- Duty factor = 10%, frequency = 1 kHz.

## Electrical/Optical Characteristics, $T_J = 25^\circ\text{C}$

Parameter	Symbol	Min.	Typ.	Max.	Units	Test Conditions
Forward Voltage	$V_F$				V	$I_F = 20\text{ mA}$
Green		2.5	2.8	3.8		
Blue		2.8	3.2	3.8		
Reverse Voltage <sup>a</sup>	$V_R$				V	$I_R = 10\ \mu\text{A}$
Green		5	—	—		
Blue		5	—	—		
Dominant Wavelength <sup>b</sup>	$\lambda_d$				nm	$I_F = 20\text{ mA}$
Green		519.0	525.0	539.0		
Blue		460.0	470.0	480.0		
Peak Wavelength	$\lambda_{PEAK}$				nm	Peak of Wavelength of Spectral Distribution at $I_F = 20\text{ mA}$
Green		—	516.0	—		
Blue		—	464.0	—		
Thermal Resistance	$R_{\theta J-PIN}$				$^\circ\text{C/W}$	LED Junction-to-Pin
Green		—	270	—		
Blue		—	480	—		

- a. Indicates product final testing condition. Long-term reverse bias is not recommended.  
b. The dominant wavelength is derived from the Chromaticity Diagram and represents the color of the lamp.

## Part Numbering System

A L M D - 

$x_1$	$x_2$	$x_3$	$x_4$
-------	-------	-------	-------

 - 

$x_5$	$x_6$	$x_7$	$x_8$	$x_9$
-------	-------	-------	-------	-------

Code	Description	Option	
$x_1$	Package type	C	Round InGaN
$x_2$	Color	B	Blue
		M	Green
$x_3$	Viewing angle	1	15°
		2	23°
$x_4$	Product specific designation	E	—
		F	—
$x_5$	Minimum intensity bin	See Intensity Bin Limit Table	
$x_6$	Maximum intensity bin		
$x_7$	Color bin	0	Full distribution
		B	Color bin 2 and bin 3
		C	Color bin 3 and bin 4
$x_8x_9$	Packaging option	02	Tested 20 mA, 13-in. carrier tape

---

## Bin Information

### Intensity Bin Limit Table (1:3:1 I<sub>v</sub> Bin Ratio)

Bin	Luminous Intensity, I <sub>v</sub> (mcd) at 20 mA	
	Min.	Max.
U	3200	4200
V	4200	5500
W	5500	7200
X	7200	9300
Y	9300	12000
Z	12000	16000
1	16000	21000
2	21000	27000
3	27000	35000
4	35000	45000

Tolerance for each bin limit is  $\pm 15\%$ .

## Green Color Range

Bin	Min. Dom.	Max. Dom.	Chromaticity Coordinate				
			x	y	z	w	
1	519.0	523.0	x	0.0667	0.1200	0.1450	0.0979
			y	0.8323	0.7375	0.7319	0.8316
2	523.0	527.0	x	0.0979	0.1450	0.1711	0.1305
			y	0.8316	0.7319	0.7218	0.8189
3	527.0	531.0	x	0.1305	0.1711	0.1967	0.1625
			y	0.8189	0.7218	0.7077	0.8012
4	531.0	535.0	x	0.1625	0.1967	0.2210	0.1929
			y	0.8012	0.7077	0.6920	0.7816
5	535.0	539.0	x	0.1929	0.2210	0.2445	0.2233
			y	0.7816	0.6920	0.6747	0.7600

Tolerance for each bin limit is  $\pm 0.5$  nm.

## Blue Color Range

Bin	Min. Dom.	Max. Dom.	Chromaticity Coordinate				
			x	y	z	w	
1	460.0	464.0	x	0.1440	0.1818	0.1766	0.1374
			y	0.0297	0.0904	0.0966	0.0374
2	464.0	468.0	x	0.1374	0.1766	0.1699	0.1291
			y	0.0374	0.0966	0.1062	0.0495
3	468.0	472.0	x	0.1291	0.1699	0.1616	0.1187
			y	0.0495	0.1062	0.1209	0.0671
4	472.0	476.0	x	0.1187	0.1616	0.1517	0.1063
			y	0.0671	0.1209	0.1423	0.0945
5	476.0	480.0	x	0.1063	0.1517	0.1397	0.0913
			y	0.0945	0.1423	0.1728	0.1327

Tolerance for each bin limit is  $\pm 0.5$  nm.

Example of bin information on reel and packaging label:

CAT: X – Intensity bin X

BIN: 2 – Color bin 2

Figure 2 Relative Intensity vs. Wavelength

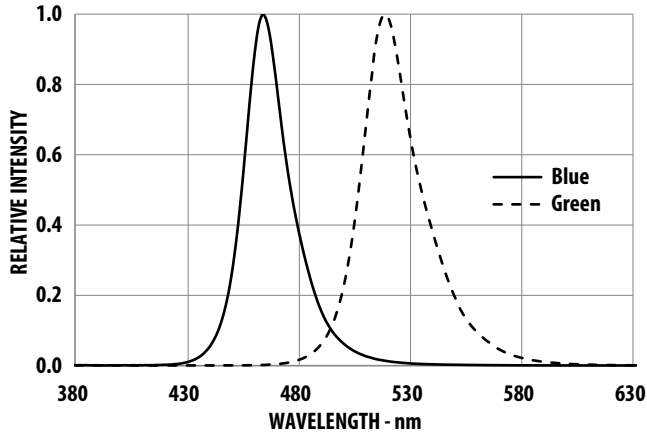


Figure 3 Forward Current vs. Forward Voltage

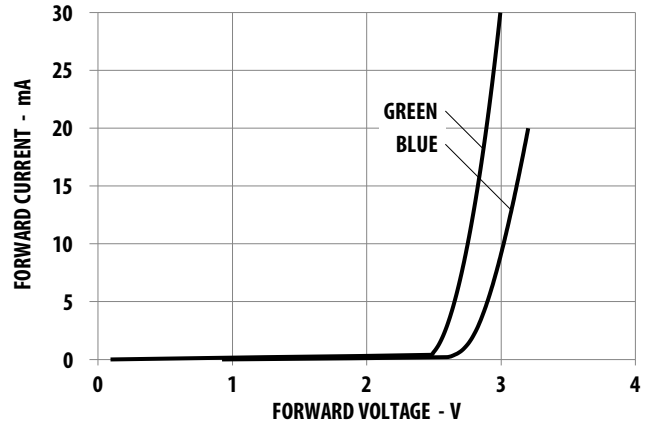


Figure 4 Relative Intensity vs. Forward Current

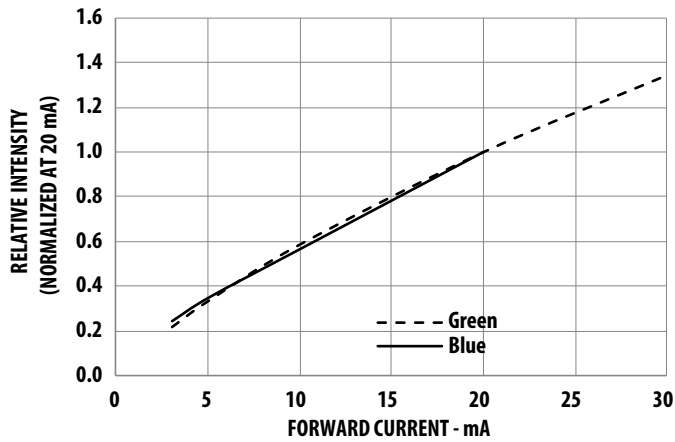


Figure 5 Maximum Forward Current vs. Ambient Temperature

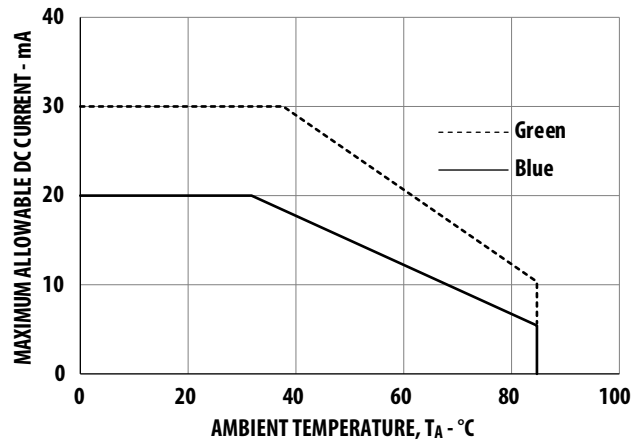


Figure 6 Relative Dominant Wavelength Shift vs. Forward Current

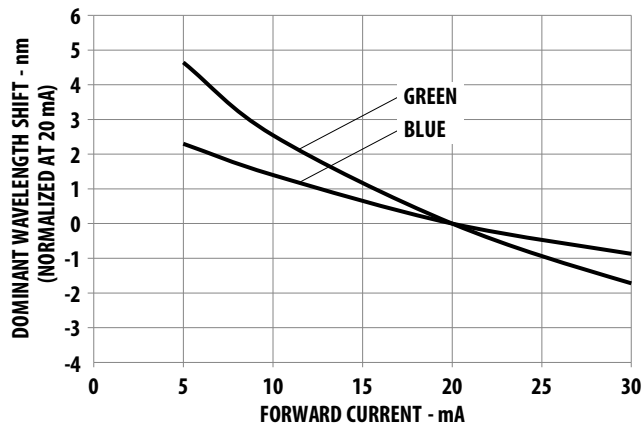


Figure 7 Radiation Pattern for X Axis -15°

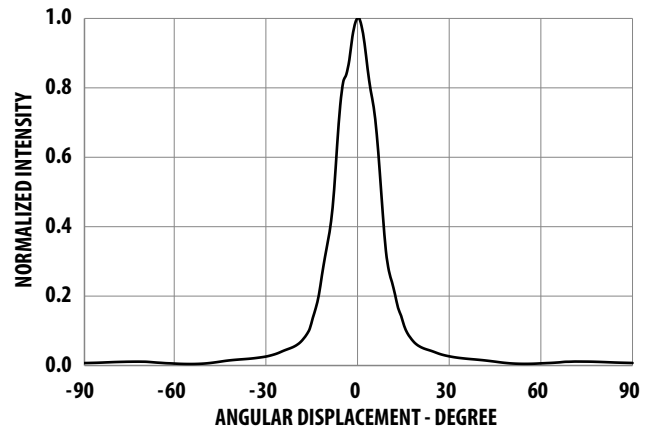


Figure 8 Radiation Pattern for X Axis -23°

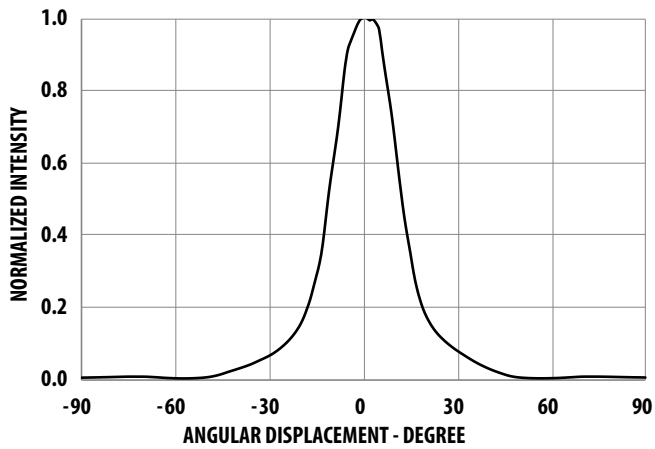


Figure 9 Component Axis for Radiation Pattern

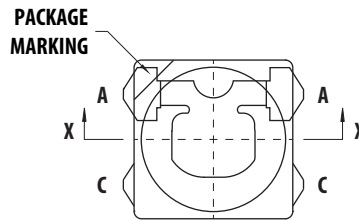


Figure 10 Relative Light Output vs. Junction Temperature

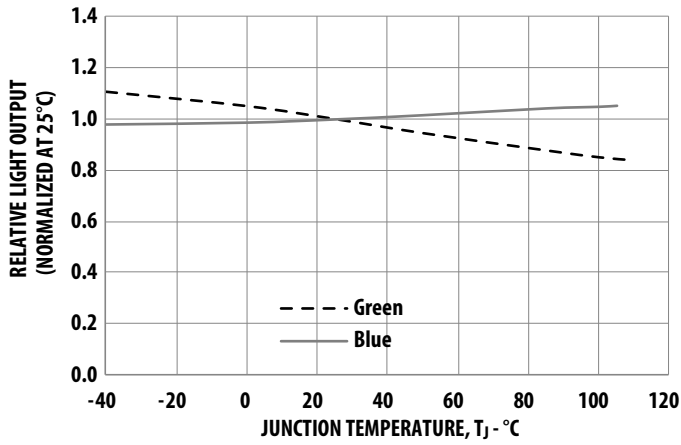


Figure 11 Forward Voltage Shift vs. Junction Temperature

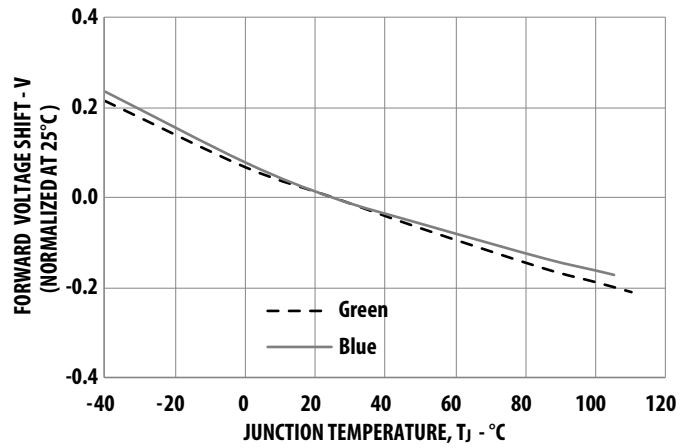
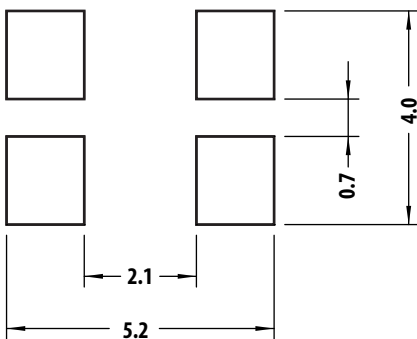


Figure 12 Recommended Soldering Land Pattern

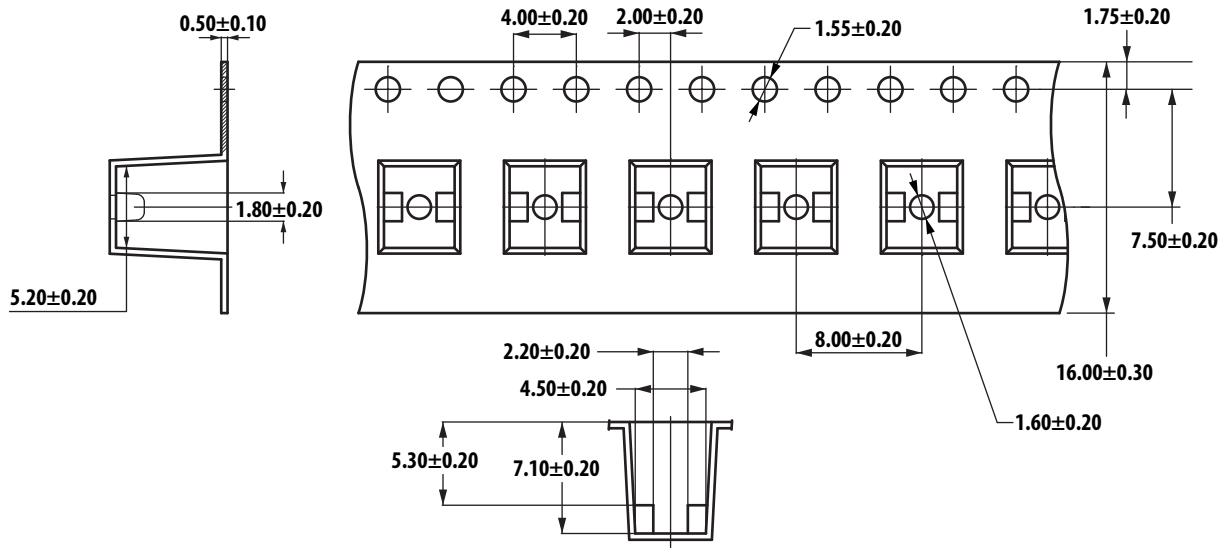


**NOTE**

1. All dimensions are in millimeters (mm).
2. Recommended stencil thickness is 0.1524 mm (6 mils) minimum and above.

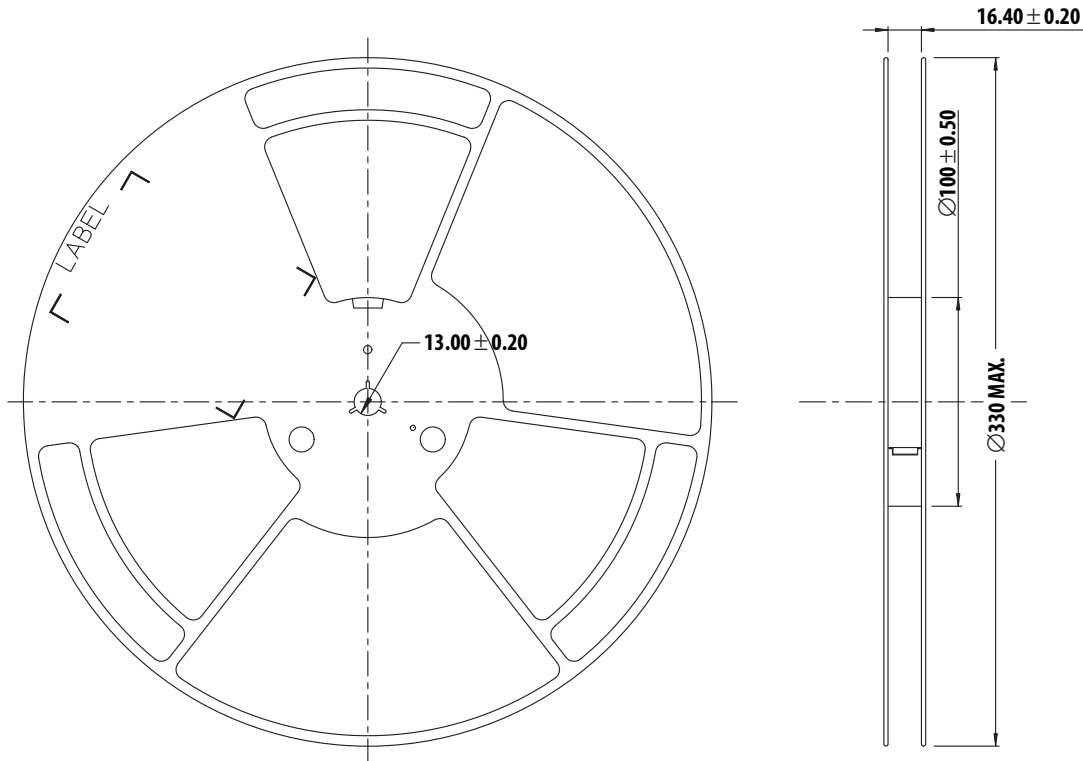


**Figure 13 Carrier Tape Dimension**



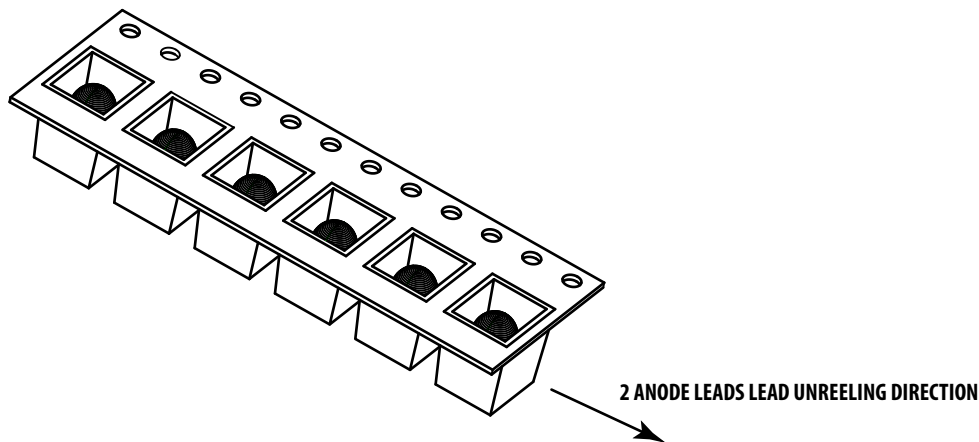
**NOTE** All dimensions are in millimeters (mm).

**Figure 14 Reel Dimension**



**NOTE** All dimensions are in millimeters (mm).

Figure 15 Unit Orientation from Reel



## Precautionary Notes

### Soldering

- Reflow soldering must not be done more than two times. Take the necessary precautions for handling a moisture-sensitive device, as stated in [Handling Precautions](#).
- Do not apply any pressure or force on the LED during reflow and after reflow when the LED is still hot.
- Use reflow soldering to solder the LED. Use hand soldering only for rework if unavoidable, but hand soldering must be strictly controlled to the following conditions:
  - Soldering iron tip temperature = 320°C maximum.
  - Soldering duration = 3s maximum.
  - Number of cycles = 1 only
  - Power of soldering iron = 50W maximum.
- Do not touch the LED body with a hot soldering iron except the soldering terminals because this might damage the LED.
- For de-soldering, use a double head soldering iron.
- Confirm beforehand whether the functionality and performance of the LED is affected by hand soldering.

Figure 16 Leaded Reflow Soldering

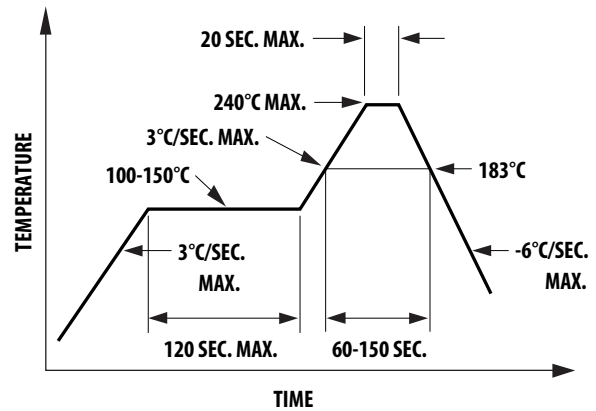
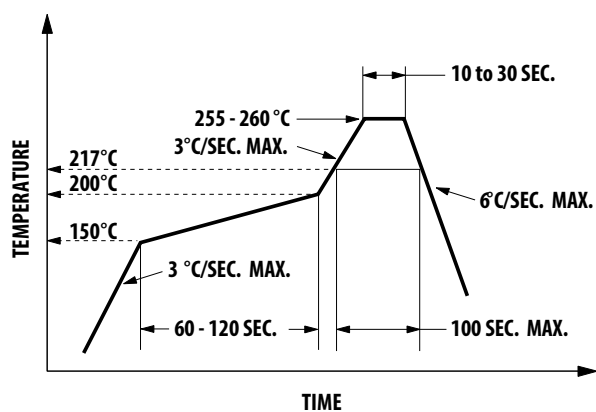
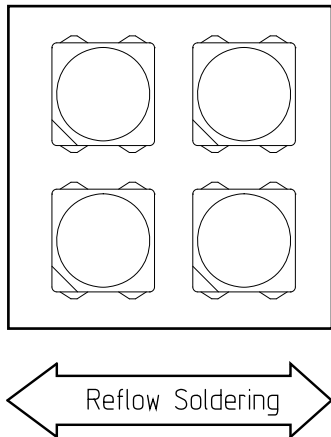


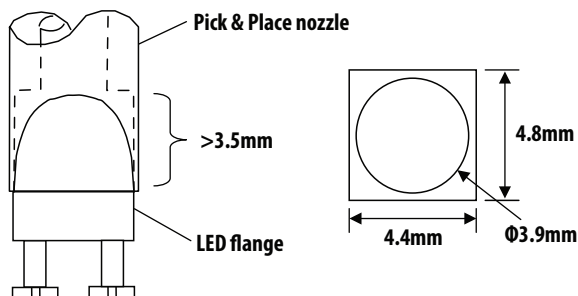
Figure 17 Lead-Free Reflow Soldering



**Figure 18 Recommended Board Reflow Direction**

## Handling Precautions

For automated pick and place, Broadcom has tested the following nozzle size made with urethane material to work well with this LED. However, due to the possibility of variations in other parameters, such as pick and place, machine maker/model, and other settings of the machine, verify the selected nozzle.

**Figure 19 Nozzle Size**

### NOTE

1. The nozzle tip should touch the LED flange during pick and place.
2. The outer dimensions of the nozzle should fit into the carrier tape pocket.

## Handling of Moisture-Sensitive Devices

This product has a Moisture Sensitive Level 2a rating per JEDEC J-STD-020. Refer to Broadcom Application Note AN5305, *Handling of Moisture Sensitive Surface Mount Devices*, for additional details and a review of proper handling procedures.

- Before use:
  - An unopened moisture barrier bag (MBB) can be stored at  $< 40^{\circ}\text{C} / 90\% \text{ RH}$  for 12 months. If the actual shelf life has exceeded 12 months and the humidity indicator card (HIC) indicates that baking is not required, then it is safe to reflow the LEDs per the original MSL rating.
  - Do not open the MBB prior to assembly (for example, for IQC).
- Control after opening the MBB:
  - Read the HIC immediately upon opening of the MBB.
  - Keep the LEDs  $< 30^{\circ}\text{C} / 60\% \text{ RH}$  at all times; all high-temperature-related processes, including soldering, curing, or rework, must be completed within 672 hours.
- Control for unfinished reel:
 

Store unused LEDs in a sealed MBB with desiccant or desiccator at  $< 5\% \text{ RH}$ .
- Control of assembled boards:
 

If the PCB soldered with the LEDs is to be subjected to other high-temperature processes, store the PCB in a sealed MBB with desiccant or desiccator at  $< 5\% \text{ RH}$  to ensure that all LEDs have not exceeded their floor life of 672 hours.
- Baking is required if:
  - The HIC indicator is *not* BROWN at 10% and is AZURE at 5%.
  - The LEDs are exposed to conditions of  $>30^{\circ}\text{C} / 60\% \text{ RH}$  at any time.
  - The LED floor life exceeded 672 hours.

The recommended baking condition is:  $60^{\circ}\text{C} \pm 5^{\circ}\text{C}$  for 20 hours. Baking should only be done once.
- Storage
 

The soldering terminals of these Broadcom LEDs are silver plated. If the LEDs are exposed for too long in an ambient environment, the silver plating might become oxidized, thus affecting its solderability performance. As such, keep unused LEDs in a sealed MBB with desiccant or in desiccator at  $< 5\% \text{ RH}$ .

---

## Application Precautions

- The drive current of the LED must not exceed the maximum allowable limit across temperature as stated in the data sheet. Constant current driving is recommended to ensure consistent performance.
- LEDs exhibit slightly different characteristics at different drive currents, which might result in larger performance variations (that is, intensity, wavelength, and forward voltage). Set the application current as close as possible to the test current to minimize these variations.
- The LED is not intended for reverse bias. Use other appropriate components for such purposes. When driving the LED in matrix form, make sure that the reverse bias voltage does not exceed the allowable limit of the LED.
- Avoid rapid changes in ambient temperature, especially in high-humidity environments, because this will cause condensation on the LED.
- If the LED is intended to be used in outdoor or harsh environments, protect the LED leads with suitable potting material against damages caused by rain water, oil, corrosive gases, and so on. Use a louver or shade to reduce direct sunlight on the LEDs.

## Eye Safety Precautions

LEDs might pose optical hazards when in operation. Do not look directly at operating LEDs because it might be harmful to the eyes. For safety reasons, use appropriate shielding or personal protective equipment.

**DISCLAIMER:** Broadcom's products and software are not specifically designed, manufactured or authorized for sale as parts, components, or assemblies for the planning, construction, maintenance, or direct operation of a nuclear facility or for use in medical devices or applications. Customers are solely responsible, and waive all rights to make claims against Broadcom or its suppliers, for all loss, damage, expense, or liability in connection with such use.

---

For product information and a complete list of distributors, please go to our web site:  
[www.broadcom.com](http://www.broadcom.com).

Broadcom, the pulse logo, Connecting everything, Avago Technologies, Avago, and the A logo are among the trademarks of Broadcom and/or its affiliates in the United States, certain other countries and/or the EU.

Copyright © 2016–2018 by Broadcom. All Rights Reserved.

The term "Broadcom" refers to Broadcom Inc. and/or its subsidiaries. For more information, please visit [www.broadcom.com](http://www.broadcom.com).

Broadcom reserves the right to make changes without further notice to any products or data herein to improve reliability, function, or design.

Information furnished by Broadcom is believed to be accurate and reliable. However, Broadcom does not assume any liability arising out of the application or use of this information, nor the application or use of any product or circuit described herein, neither does it convey any license under its patent rights nor the rights of others.

pub-005360 – May 10, 2018



# Mouser Electronics

Authorized Distributor

Click to View Pricing, Inventory, Delivery & Lifecycle Information:

[Broadcom Limited:](#)

[ALMD-CB1E-VW002](#) [ALMD-CB2E-UV002](#) [ALMD-CM1F-34002](#) [ALMD-CM2F-12002](#)