

THIS DRAWING IS UNPUBLISHED. RELEASED FOR PUBLICATION 20
 © COPYRIGHT 20 BY - ALL RIGHTS RESERVED.

LOC		DIST		REVISIONS			
P	LTR	DESCRIPTION		DATE	DWN	APVD	
	B1	REVISED PER ECR-15-008087		03JUN2015	NK	JR	

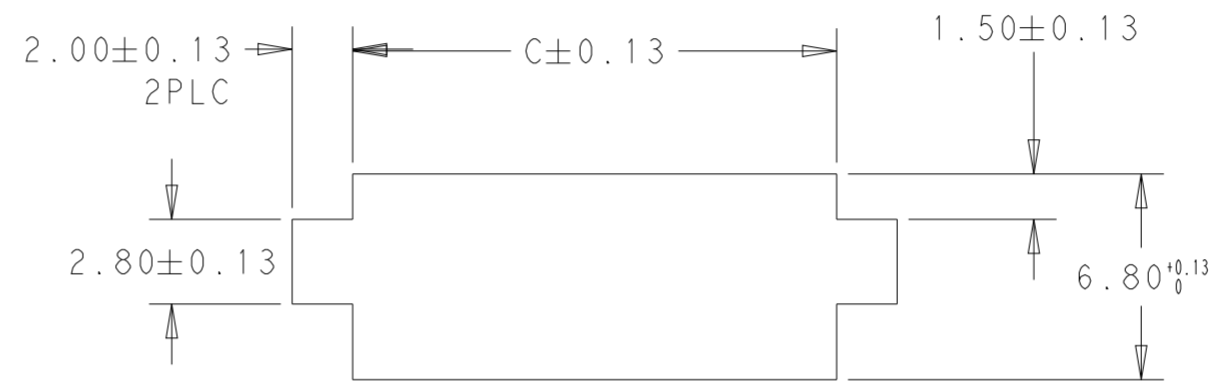

1. MATERIAL: NYLON UL94V-0, FLAME RETARDANT, COLOR: NATURAL
2. PARTS TESTED TO IEC 60695-2-11 AND IS COMPLIANT TO IEC 60335-1.
3. HOUSING, MATERIAL MEETS MINIMUM GLOW WIRE FLAMMIBILITY INDEX OF 850°C PER IEC 60695-2-12 AND MINIMUM GLOW WIRE IGNITION TEMP OF 775°C PER IEC 60695-2-13.
4. ACCEPTS TE PIN CONTACTS P/N'S 2238007-(-)
5. HOUSING ACCEPTS OPTIONAL TPA P/N'S 1969443-(-)
6. MATES WITH TE PLUG HOUSINGS P/N'S 1744417-(-)

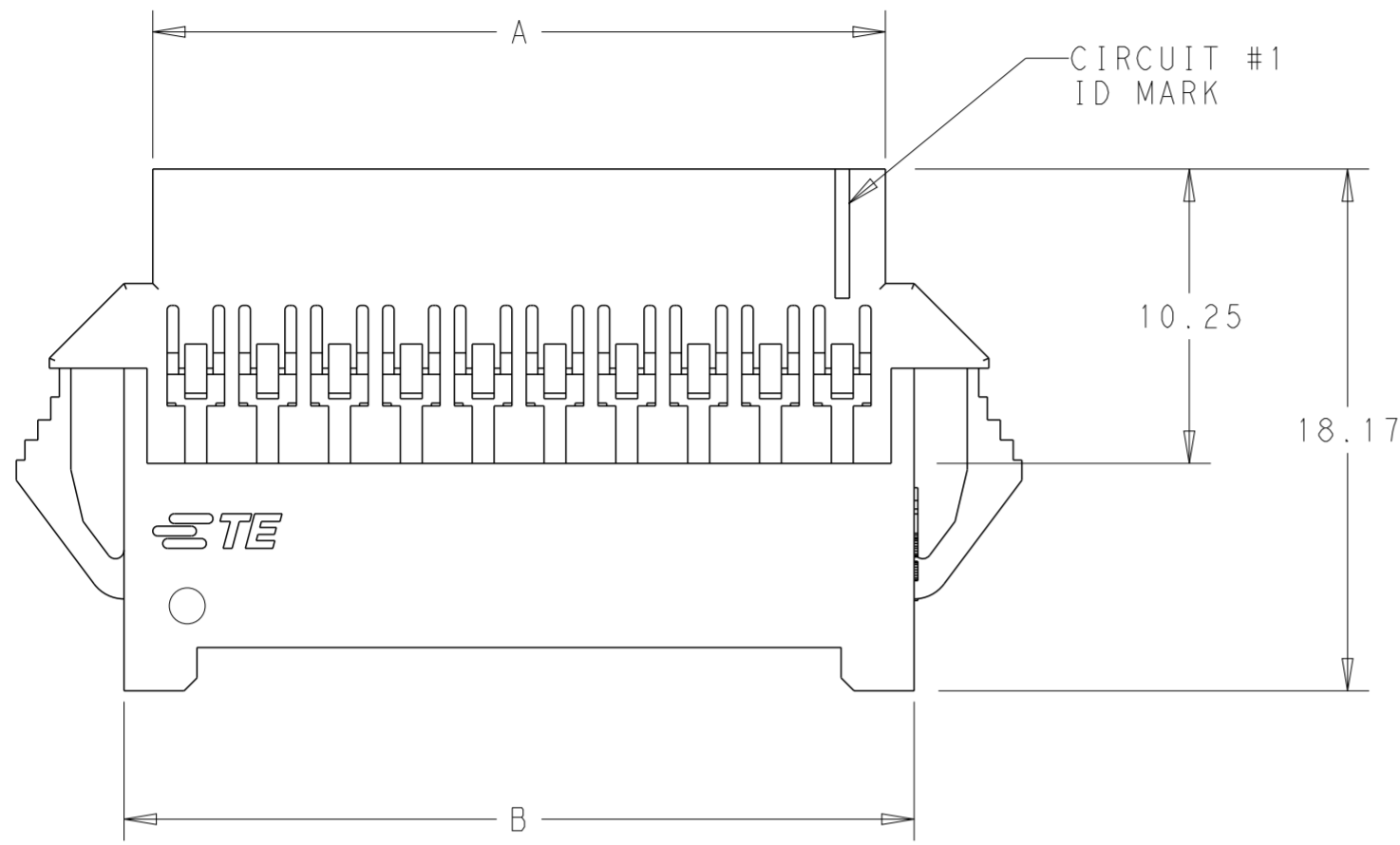
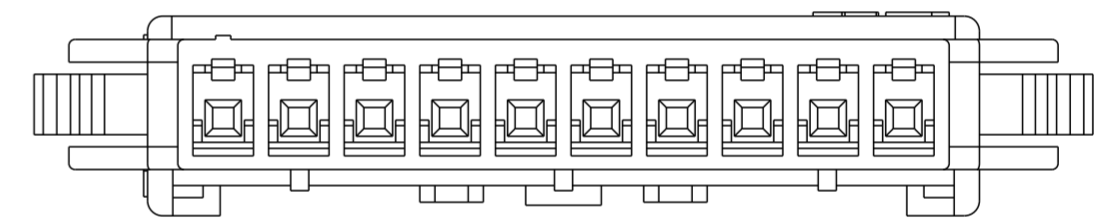
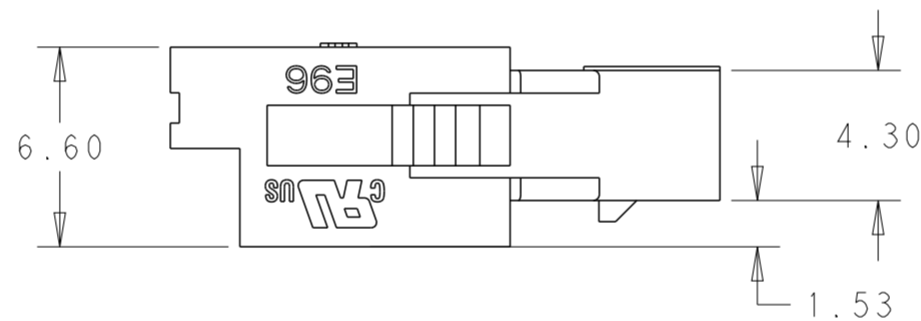
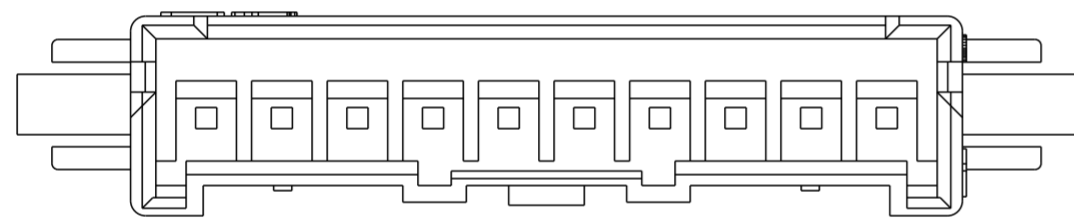

6 TO 15 POSITION
 1969591-6 TO 1-1969591-5

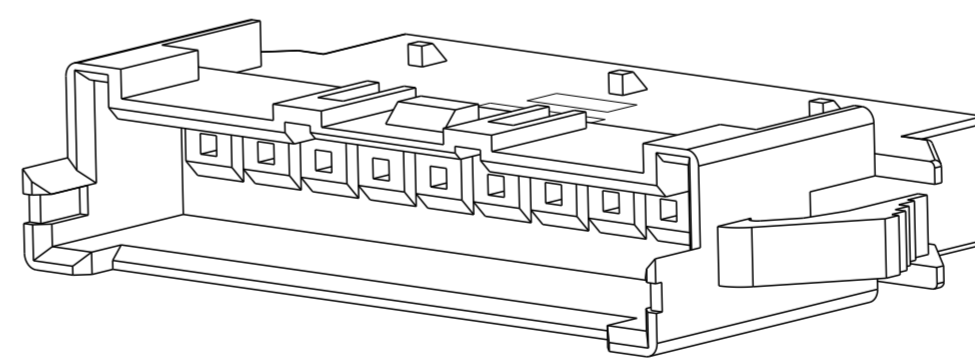
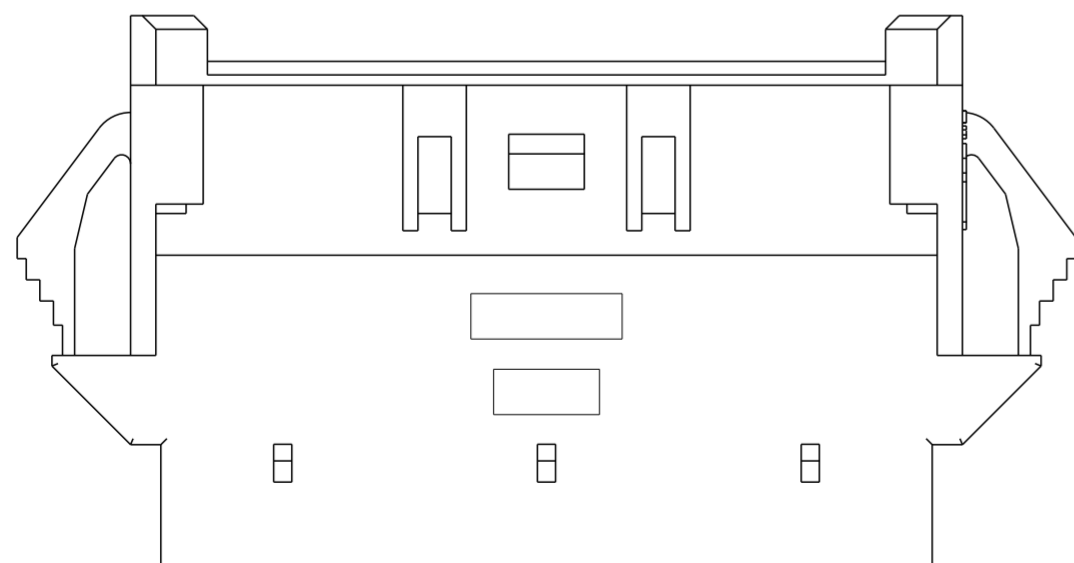

POS	DIM.C	DIM.B	DIM.A	PART NO.
15	41.00	40.00	38.00	1-1969591-5
14	38.50	37.50	35.50	1-1969591-4
13	34.00	35.00	33.00	1-1969591-3
12	33.50	32.50	30.50	1-1969591-2
11	31.00	30.00	28.00	1-1969591-1
10	28.50	27.50	25.50	1-1969591-0
9	26.00	25.00	23.00	1969591-9
8	23.50	22.50	20.50	1969591-8
7	21.00	20.00	18.00	1969591-7
6	18.50	17.50	15.50	1969591-6
5	16.00	15.00	13.00	1969591-5
4	13.50	12.50	10.50	1969591-4
3	11.00	10.00	8.00	1969591-3
2	8.50	7.50	5.50	1969591-2

THIS DRAWING IS A CONTROLLED DOCUMENT. DWN: A, NOEL, 03OCT2012
 CHK: -
 APVD: -

DIMENSIONS: mm	TOLERANCES UNLESS OTHERWISE SPECIFIED:	PRODUCT SPEC	ECONOMY POWER 2.5, HOUSING WIRE TO WIRE, PANEL MOUNT, GLOW WIRE	
0 PLC ±	1 PLC ±	108-2418	SIZE	RESTRICTED TO
2 PLC ±0.20	3 PLC ±	APPLICATION SPEC	A2	
4 PLC ±	ANGLES ±	114-13315	CAGE CODE	DRAWING NO
MATERIAL	FINISH	WEIGHT	A200779	C-1969591
SEE TABLE	SEE TABLE	Customer Drawing	SCALE 4:1	SHEET 1 OF 2

TE Connectivity

THIS DRAWING IS UNPUBLISHED. RELEASED FOR PUBLICATION 20
 © COPYRIGHT 20 BY - ALL RIGHTS RESERVED.

LOC		DIST		REVISIONS			
P	LTR	DESCRIPTION	DATE	DWN	APVD		
-	-	SEE SHEET 1	-	-	-		

2 POSITION
1969591-2

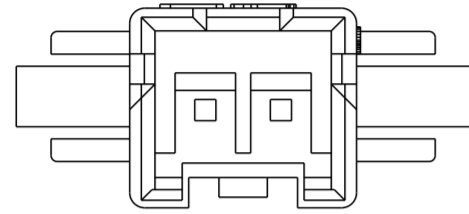

3 POSITION
1969591-3

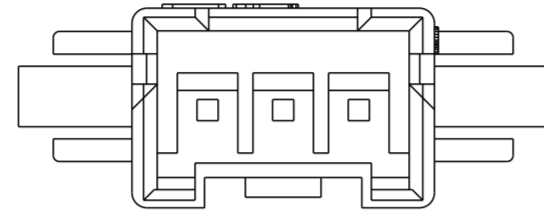

4 POSITION
1969591-4

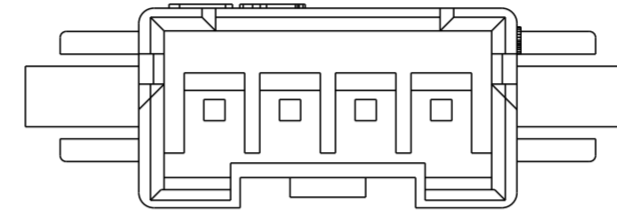

5 POSITION
1969591-5

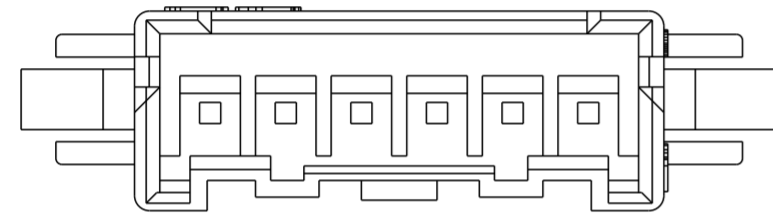
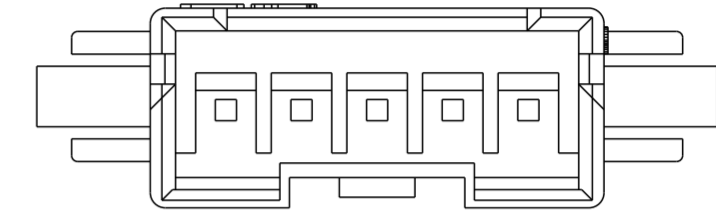

6 - 15 POSITION
1969591-6 TO 1-1969591-5

THIS DRAWING IS A CONTROLLED DOCUMENT.		DWN A. NOEL	03OCT2012	 TE Connectivity	
DIMENSIONS: mm		CHK -	APVD -		
TOLERANCES UNLESS OTHERWISE SPECIFIED:		PRODUCT SPEC 108-2418		RESTRICTED TO -	
0 PLC ± 1 PLC ± 2 PLC ±0.20 3 PLC ± 4 PLC ± ANGLES ± FINISH		APPLICATION SPEC 114-13315		SIZE A2	CAGE CODE 00779
MATERIAL SEE TABLE		WEIGHT -		DRAWING NO C-1969591	
SEE TABLE		Customer Drawing		SCALE 4:1	SHEET 2 OF 2
				REV B1	

Mouser Electronics

Authorized Distributor

Click to View Pricing, Inventory, Delivery & Lifecycle Information:

[TE Connectivity:](#)

[1-1969591-1](#)