

Features

- Low operating voltage: 5V
- Ultra low capacitance: 0.2 pF typical (IO to IO)
- Ultra low leakage: nA level
- Low clamping voltage
- Complies with following standards:
 - - IEC 61000-4-2 (ESD) immunity test
 - Air discharge: $\pm 22\text{kV}$
 - Contact discharge: $\pm 20\text{kV}$
 - - IEC61000-4-5 (Lightning) 3A (8/20 μs)
- These are Pb-Free Devices
- Response Time is Typically $< 1\text{ ns}$

Mechanical Characteristics

- Package: TSFP-3
- Lead Finish: Matte Tin
- Case Material: "Green" Molding Compound.
- Moisture Sensitivity: Level 3 per J-STD-020
- Terminal Connections: See Diagram Below
- Shipping Qty : 8000pcs/7Inch Tape & Reel

Applications

- Cellular Handsets and Accessories
- Personal Digital Assistants
- Notebooks and Handhelds
- Portable Instrumentation
- Digital Cameras
- Peripherals

Dimensions and Pin Configuration

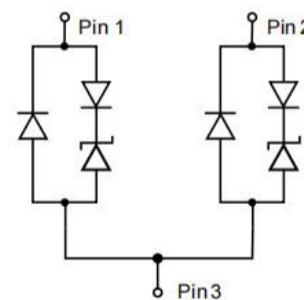
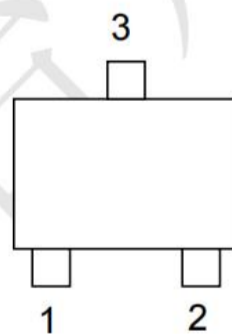

Absolute Maximum Ratings (Tamb=25°C unless otherwise specified)

Parameter	Symbol	Value	Unit
Peak Pulse Current (8/20μs)	Ipp	3	A
ESD per IEC 61000-4-2 (Air)	VESD	±22	kV
ESD per IEC 61000-4-2 (Contact)		±20	
Operating Temperature Range	TJ	-55 to +125	°C
Storage Temperature Range	Tstg	-55 to +150	°C

Electrical Characteristics (TA=25°C unless otherwise specified)

Parameter	Symbol	Min	Typ	Max	Unit	Test Condition
Reverse Working Voltage	VRWM			5	V	
Breakdown Voltage	VBR	6	7.5	8.6	V	IT = 1mA
Reverse Leakage Current	IR			0.07	uA	VRWM = 5V
Clamping Voltage	VC			12	V	Ipp=1A(8x 20us pulse)
Clamping Voltage	VC			20	V	Ipp=3A(8x 20us pulse)
Junction Capacitance	CJ		0.35		pF	VR = 0V, f = 1MHz IO to GND
Junction Capacitance	CJ		0.2	0.25	pF	VR = 0V, f = 1MHz IO to IO

Typical Performance Characteristics ($T_A=25^\circ\text{C}$ unless otherwise Specified)

Fig1. 8/20 μs Pulse Waveform

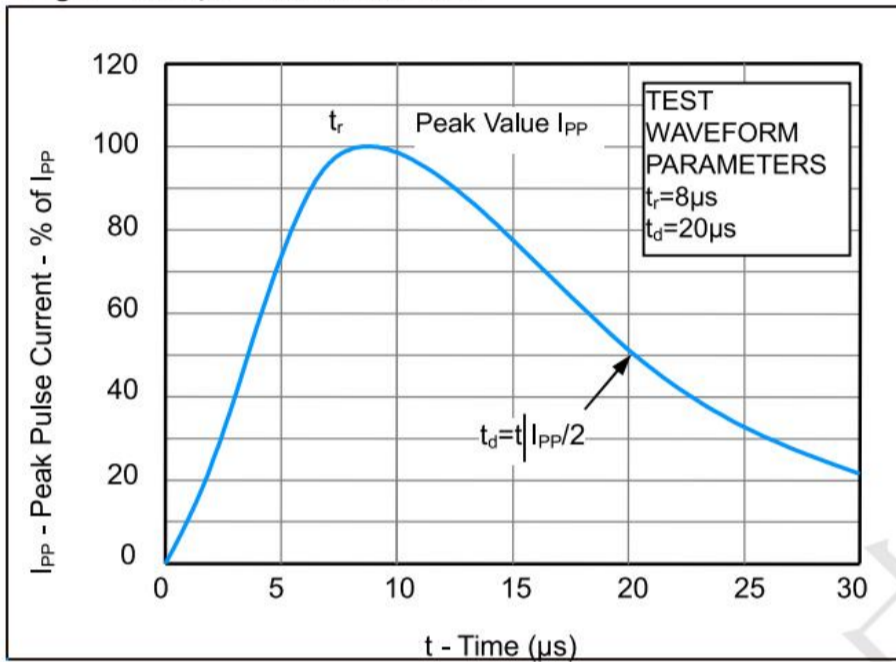

Fig2. ESD Pulse Waveform (according to IEC 61000-4-2)

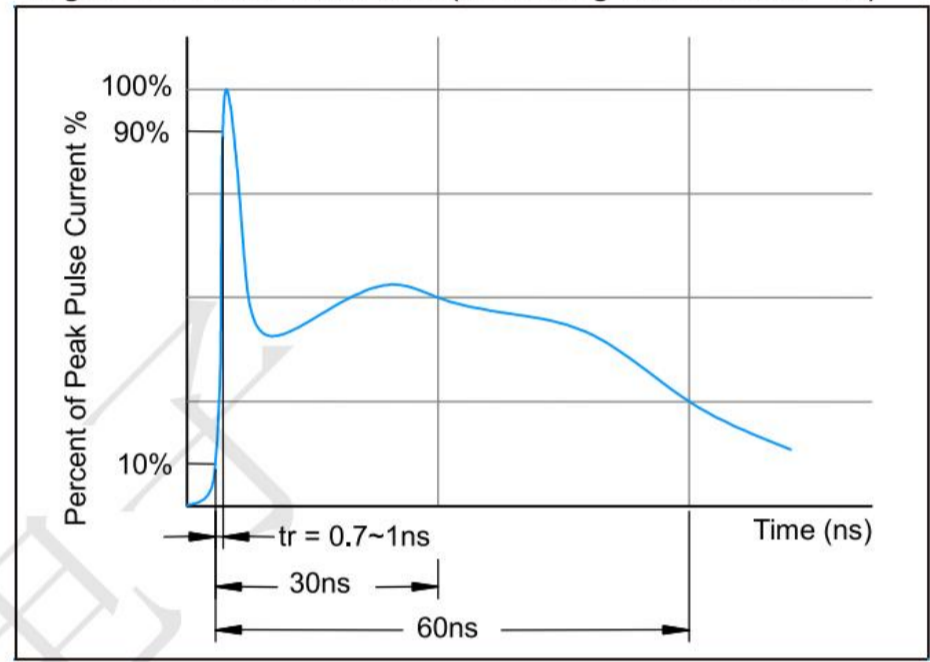
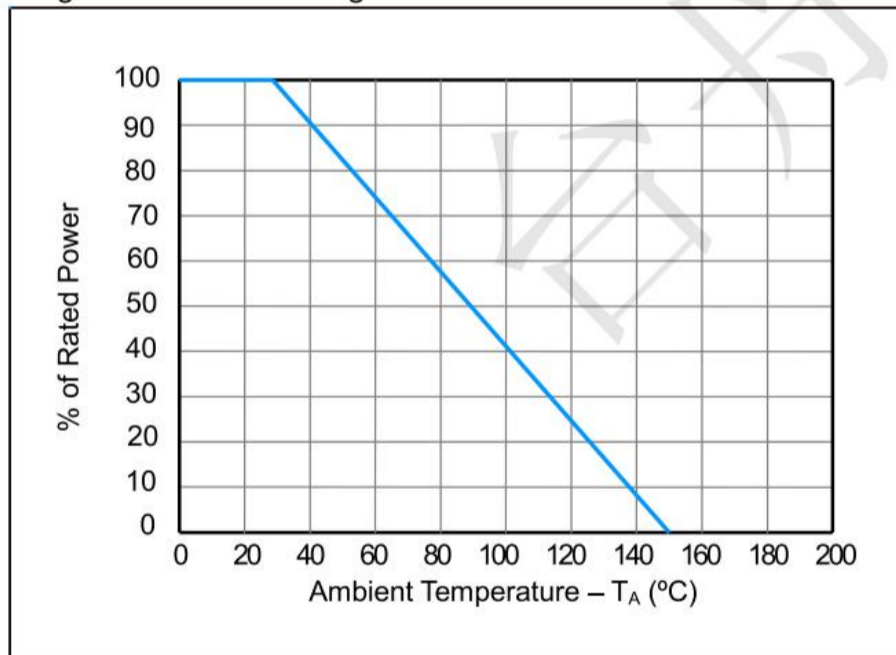
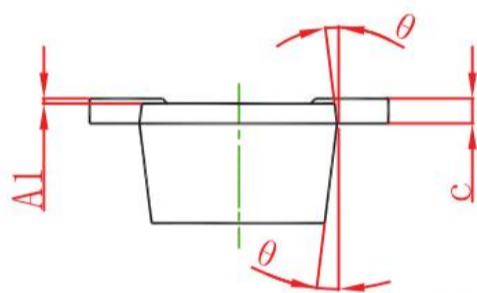
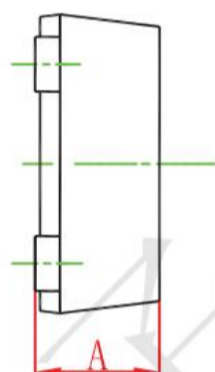
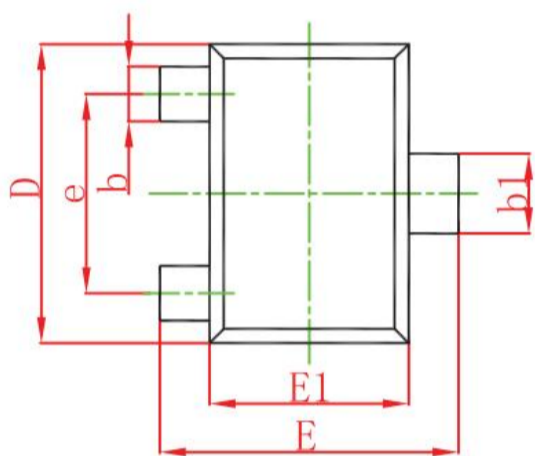

Fig3. Power Derating Curve



TSFP-3 Package Outline Dimensions

www.sot23.com.tw



Symbol	Dimensions In Millimeters		Dimensions In Inches	
	Min.	Max.	Min.	Max.
A	0.430	0.500	0.017	0.020
A1	0.000	0.050	0.000	0.002
b	0.170	0.270	0.007	0.011
b1	0.270	0.370	0.011	0.015
c	0.080	0.150	0.003	0.006
D	1.150	1.250	0.045	0.049
E	1.150	1.250	0.045	0.049
E1	0.750	0.850	0.030	0.033
e	0.800TYP.		0.031TYP.	
θ	7° REF.		7° REF.	