

Features/Benefits

- **D*Sub Connector Type**
- **Contacts installed in factory**
- **Multiple contacts configuration: Solder Cup, 90° bent, Straight PC, Wire-wrap**
- **From 9 to 50 ways**

Typical Applications

- **Payloads PCB**
- **Launchers**
- **PCB Test**

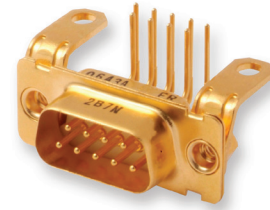

Connectors with solder type or wire-wrap type termination contacts size 20 inserted into one-piece insulators.

Termination types available:

- Solder Bucket terminations
- Straight PCB solder terminations
- 90° bent PCB solder terminations
- Wire-wrap terminations

Combination arrangements available for size 8 snap-in coaxial, power, or high voltage contacts

Connectors supplied without coaxial power or high voltage contacts. Power and coaxial contacts have to be ordered separately but signal contacts are installed in factory.

Signal contact are solder bucket type. Other type could be asked under request.

Packaging unit: 1 piece (plastic bag)

Dust cap supplied with each connector, only for quality level ESA/ESCC

How to order – ESA/ESCC Quality Level

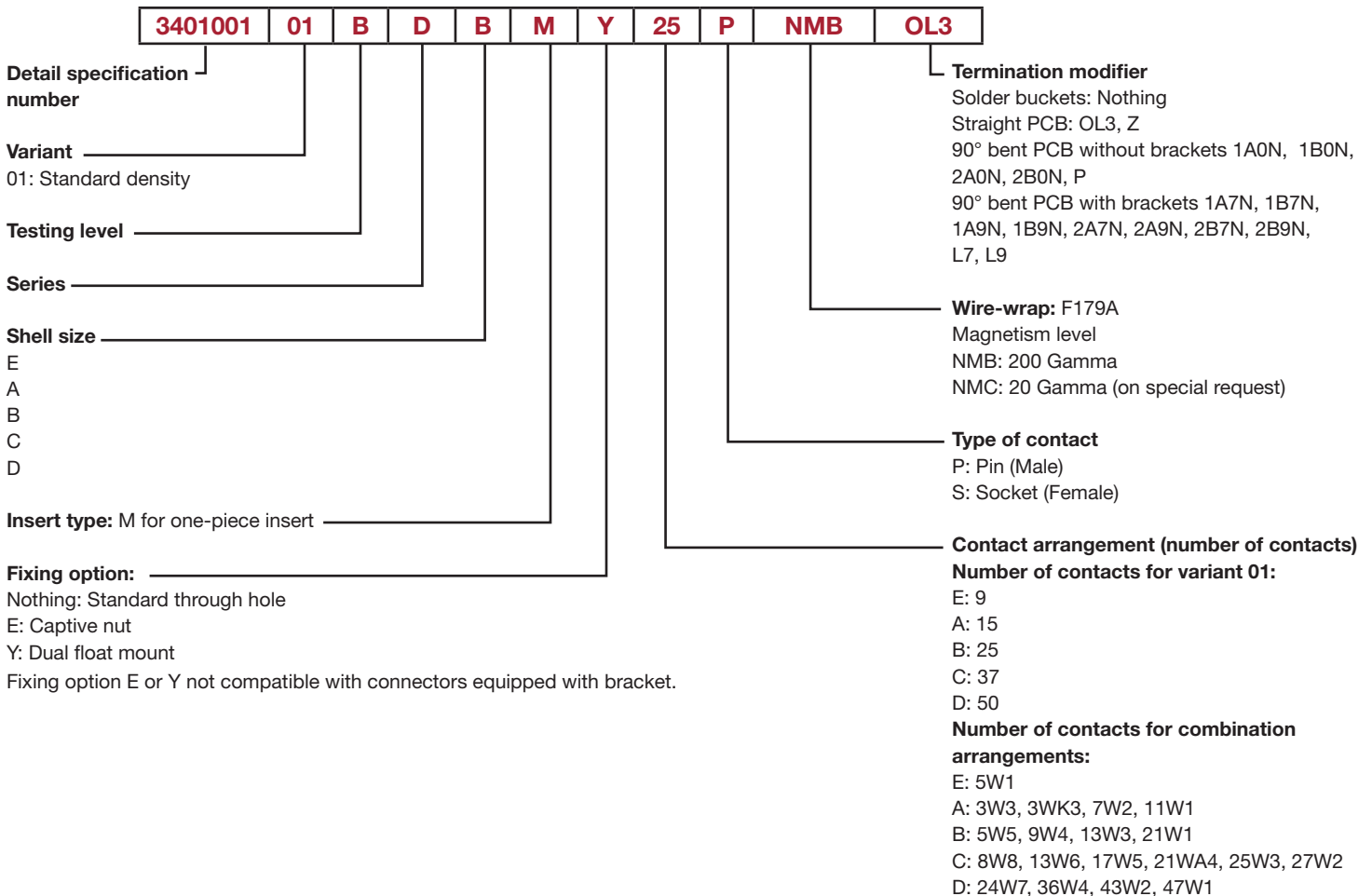

3401-001 D*M Standard Density

How to order – FR022 Quality Level

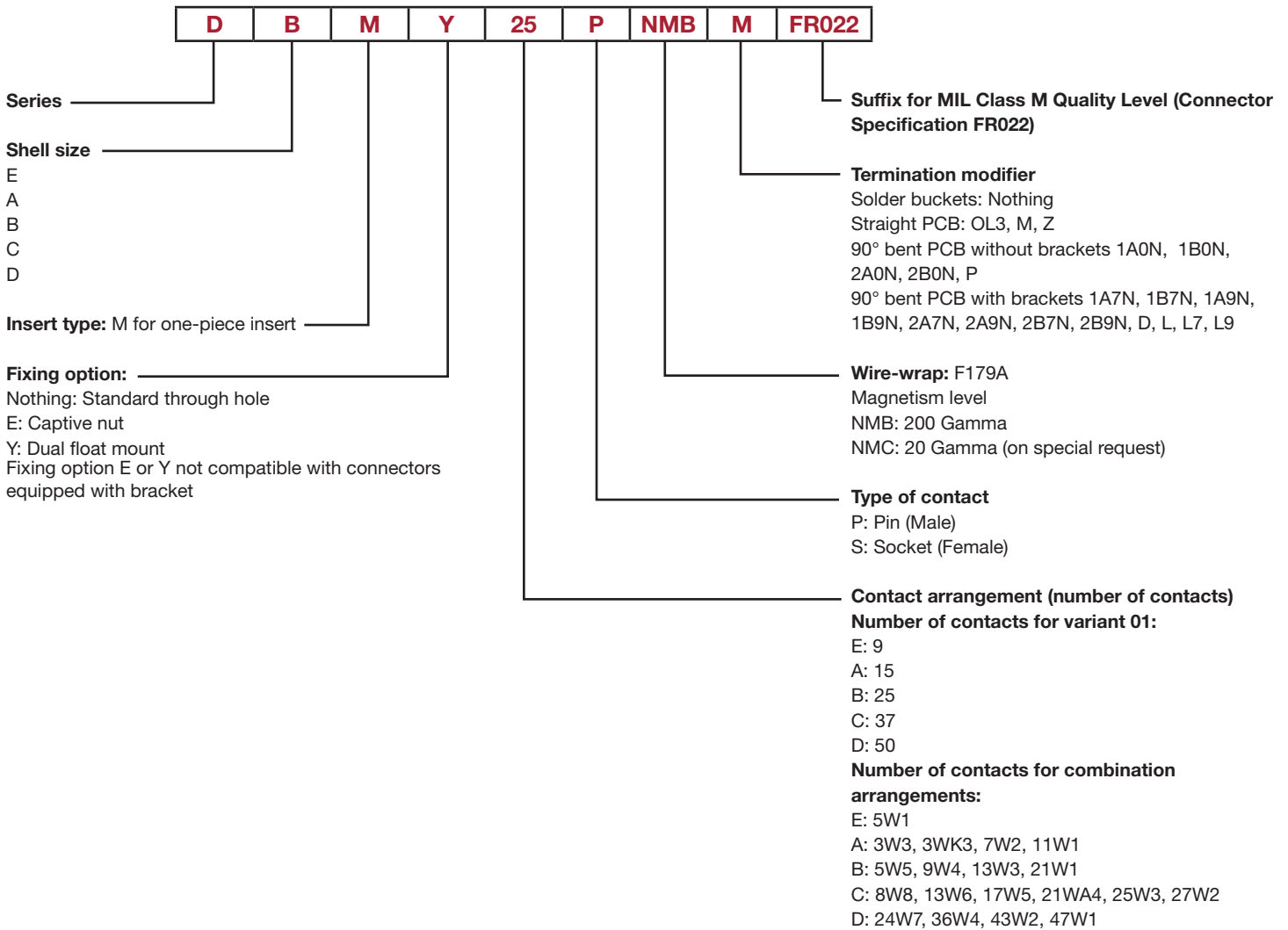

3401-001 D*M Standard Density

Specific Dimensions

Termination Types

Solder Bucket

Straight PCB Solder

90° Bent PCB Solder / Without Bracket / European Footprint

90° Bent PCB Solder / With Brackets / European Footprint

90° Bent PCB Solder / Without Brackets / U.S. Footprint

90° Bent PCB Solder / With Brackets / U.S. Footprint

Wire-Wrap

Male Connector

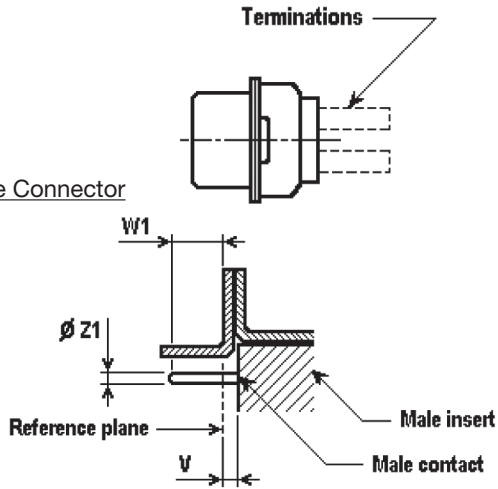

Female Connector

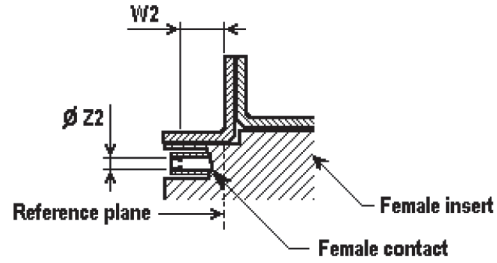

Ø Z2: to accommodate a 0,99 (.039) / 1,04 (.041) diameter pin

Shell Size	V max	W1 min (Full pin diameter)	W1 max (Full pin length)	ØZ1 min	ØZ1 max	W2 min (Square ended pin)
E	0,40 (.016)	4,47 (.176)	5,33 (.210)	0,99 (.039)	1,04 (.041)	4,36 (.172)
A	0,40 (.016)	4,47 (.176)	5,33 (.210)	0,99 (.039)	1,04 (.041)	4,36 (.172)
B	0,60 (.024)	4,47 (.176)	5,33 (.210)	0,99 (.039)	1,04 (.041)	4,36 (.172)
C	0,60 (.024)	4,47 (.176)	5,33 (.210)	0,99 (.039)	1,04 (.041)	4,36 (.172)
D	0,60 (.024)	4,47 (.176)	5,33 (.210)	0,99 (.039)	1,04 (.041)	4,36 (.172)

Weights

Max Weight (grams) without contacts or accessories	Shell Size	Weight (Grams)	
		Male	Female
	E	4,5	5,0
	A	5,5	7,0
	B	9,0	10,0
	C	12,5	13,5
	D	13,5	15,0

For the total connector weight, add the weight of the contacts and of the eventual accessories.*

* For the weight of the contacts, refer to the tables on the following pages.
 For dual-float amount (Y) weight (if applicable), added 0,60 grams.
 For captive-nut, (E) weight (if applicable), added 0,65 grams.

3401-001 D*M Standard Density

Solder Bucket Terminations:

Specific Dimensions

Sizes E, A, B, C

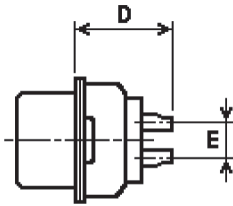

Size D

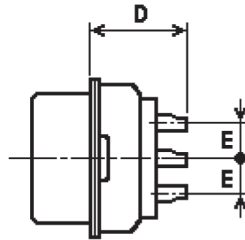

Termination

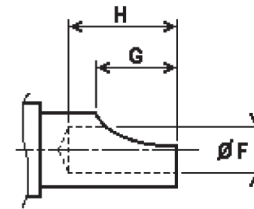

Contacts	Shell Size	D ± 0,60 (.024)	E Typical	ØF + 0,05 (.002) / 0	G ± 0,55 (.022)	H min	Pitch between contacts
Male	E	9,60 (.378)	2,84 (.112)	1,10 (.043)	1,95 (.077)	2,40 (.094)	2,74 (.108)
	A	9,60 (.378)	2,84 (.112)	1,10 (.043)	1,95 (.077)	2,40 (.094)	2,74 (.108)
	B	9,80 (.386)	2,84 (.112)	1,10 (.043)	1,95 (.077)	2,40 (.094)	2,76 (.109)
	C	9,80 (.386)	2,84 (.112)	1,10 (.043)	1,95 (.077)	2,40 (.094)	2,76 (.109)
	D	9,80 (.386)	2,84 (.112)	1,10 (.043)	1,95 (.077)	2,40 (.094)	2,76 (.109)
Female	E	9,60 (.378)	2,84 (.112)	1,10 (.043)	1,95 (.077)	2,40 (.094)	2,74 (.108)
	A	9,60 (.378)	2,84 (.112)	1,10 (.043)	1,95 (.077)	2,40 (.094)	2,74 (.108)
	B	9,60 (.378)	2,84 (.112)	1,10 (.043)	1,95 (.077)	2,40 (.094)	2,76 (.109)
	C	9,60 (.378)	2,84 (.112)	1,10 (.043)	1,95 (.077)	2,40 (.094)	2,76 (.109)
	D	9,60 (.378)	2,84 (.112)	1,10 (.043)	1,95 (.077)	2,40 (.094)	2,76 (.109)

Termination Modifier: Nothing

Weights

	Shell Size	Male Contact	Female Contact
Max Weight (grams) per contact		0,19	0,22
Max Weight (grams) of all contacts per size	E	1,71	1,98
	A	2,85	3,30
	B	4,75	5,50
	C	7,03	8,14
	D	9,50	11,00

Recommended instruction for wire stripping:

Cut wires to length and strip insulation per illustration.
Check for broken or frayed wires.
Accepted wire sizes: insulated AWG20, AWG22, AWG24

Recommended wire trim length

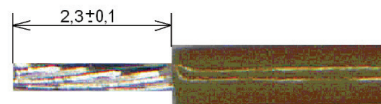

3401-001 D*M Standard Density

Cross References

Solder bucket

Standard

Description ESA/ESCC	Part Number
340100101B DEM 9P NMB	C115371-5000
340100101B DEM 9S NMB	C115371-5001
340100101B DAM 15P NMB	C115371-5004
340100101B DAM 15S NMB	C115371-5005
340100101B DBM 25P NMB	C115371-5014
340100101B DBM 25S NMB	C115371-5015
340100101B DCM 37P NMB	C115371-5026
340100101B DCM 37S NMB	C115371-5027
340100101B DDM 50P NMB	C115371-5040
340100101B DDM 50S NMB	C115371-5041

Description FR022	Part Number
DEM 9P NMB-FR022	C115371-3000
DEM 9S NMB-FR022	C115371-3001
DAM 15P NMB-FR022	C115371-3004
DAM 15S NMB-FR022	C115371-3005
DBM 25P NMB-FR022	C115371-3014
DBM 25S NMB-FR022	C115371-3015
DCM 37P NMB-FR022	C115371-3026
DCM 37S NMB-FR022	C115371-3027
DDM 50P NMB-FR022	C115371-3040
DDM 50S NMB-FR022	C115371-3041

Option Y

Description ESA/ESCC	Part Number
340100101B DEMY 9P NMB	C115371-5050
340100101B DEMY 9S NMB	C115371-5051
340100101B DAMY 15P NMB	C115371-5054
340100101B DAMY 15S NMB	C115371-5055
340100101B DBMY 25P NMB	C115371-5064
340100101B DBMY 25S NMB	C115371-5065
340100101B DCMY 37P NMB	C115371-5076
340100101B DCMY 37S NMB	C115371-5077
340100101B DDMY 50P NMB	C115371-5090
340100101B DDMY 50S NMB	C115371-5091

Description FR022	Part Number
DEMY 9P NMB-FR022	C115371-3050
DEMY 9S NMB-FR022	C115371-3051
DAMY 15P NMB-FR022	C115371-3054
DAMY 15S NMB-FR022	C115371-3055
DBMY 25P NMB-FR022	C115371-3064
DBMY 25S NMB-FR022	C115371-3065
DCMY 37P NMB-FR022	C115371-3076
DCMY 37S NMB-FR022	C115371-3077
DDMY 50P NMB-FR022	C115371-3090
DDMY 50S NMB-FR022	C115371-3091

Option E

Description ESA/ESCC	Part Number
340100101B DEME 9P NMB	C115371-5100
340100101B DEME 9S NMB	C115371-5101
340100101B DAME 15P NMB	C115371-5104
340100101B DAME 15S NMB	C115371-5105
340100101B DBME 25P NMB	C115371-5114
340100101B DBME 25S NMB	C115371-5115
340100101B DCME 37P NMB	C115371-5126
340100101B DCME 37S NMB	C115371-5127
340100101B DDME 50P NMB	C115371-5140
340100101B DDME 50S NMB	C115371-5141

Description FR022	Part Number
DEME 9P NMB-FR022	C115371-3100
DEME 9S NMB-FR022	C115371-3101
DAME 15P NMB-FR022	C115371-3104
DAME 15S NMB-FR022	C115371-3105
DBME 25P NMB-FR022	C115371-3114
DBME 25S NMB-FR022	C115371-3115
DCME 37P NMB-FR022	C115371-3126
DCME 37S NMB-FR022	C115371-3127
DDME 50P NMB-FR022	C115371-3140
DDME 50S NMB-FR022	C115371-3141



Dimensions are shown in mm (inch)
Dimensions subject to change

3401-001 D*M Standard Density

Straight PCB solder Terminations type OL3, M, Z

Specific Dimensions

Sizes E, A, B, C

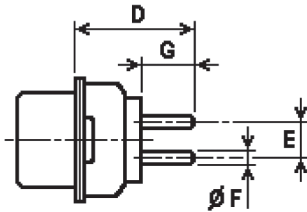

Size D

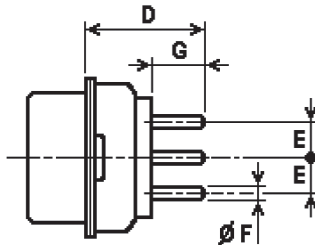

Termination Modifier	ØF ± 0,05 (.002)	G ± 0,20 (.008)
OL3	0,60 (.024)	4,15 (.163)
M*	0,76 (.030)	3,65 (.144)
Z	0,76 (.030)	4,65 (.183)

Contacts	Shell Size	D min	D max	E Typical	Pitch between contacts
Male	E	10,00 (.394)	11,20 (.441)	2,84 (.112)	2,74 (.108)
	A	10,00 (.394)	11,20 (.441)	2,84 (.112)	2,74 (.108)
	B	10,20 (.402)	11,40 (.449)	2,84 (.112)	2,76 (.109)
	C	10,20 (.402)	11,40 (.449)	2,84 (.112)	2,76 (.109)
	D	10,20 (.402)	11,40 (.449)	2,84 (.112)	2,76 (.109)
Female	E	10,00 (.394)	11,20 (.441)	2,84 (.112)	2,74 (.108)
	A	10,00 (.394)	11,20 (.441)	2,84 (.112)	2,74 (.108)
	B	10,00 (.394)	11,20 (.441)	2,84 (.112)	2,76 (.109)
	C	10,00 (.394)	11,20 (.441)	2,84 (.112)	2,76 (.109)
	D	10,00 (.394)	11,20 (.441)	2,84 (.112)	2,76 (.109)

Termination Modifier: OL3, M, Z

For other termination modifier, consult factory

Weights

	Shell Size	Male Contact	Female Contact
Max Weight (grams) per contact		0,17	0,20
Max Weight (grams) of all contacts per size	E	1,53	1,80
	A	2,55	3,00
	B	4,25	5,00
	C	6,29	7,40
	D	8,50	10,00

3401-001 D*M Standard Density

Cross References

Solder bucket

Standard

Description ESA/ESCC	Part Number
340100101B DEM 9P NMB OL3	C115371-5150
340100101B DEM 9S NMB OL3	C115371-5151
340100101B DAM 15P NMB OL3	C115371-5154
340100101B DAM 15S NMB OL3	C115371-5155
340100101B DBM 25P NMB OL3	C115371-5160
340100101B DBM 25S NMB OL3	C115371-5161
340100101B DCM 37P NMB OL3	C115371-5170
340100101B DCM 37S NMB OL3	C115371-5171
340100101B DDM 50P NMB OL3	C115371-5182
340100101B DDM 50S NMB OL3	C115371-5183
340100101B DEM 9P NMB Z	C115371-5300
340100101B DEM 9S NMB Z	C115371-5301
340100101B DAM 15P NMB Z	C115371-5304
340100101B DAM 15S NMB Z	C115371-5305
340100101B DBM 25P NMB Z	C115371-5310
340100101B DBM 25S NMB Z	C115371-5311
340100101B DCM 37P NMB Z	C115371-5320
340100101B DCM 37S NMB Z	C115371-5321
340100101B DDM 50P NMB Z	C115371-5332
340100101B DDM 50S NMB Z	C115371-5333

Description FR022	Part Number
DEM 9P NMB OL3-FR022	C115371-3150
DEM 9S NMB OL3-FR022	C115371-3151
DAM 15P NMB OL3-FR022	C115371-3154
DAM 15S NMB OL3-FR022	C115371-3155
DBM 25P NMB OL3-FR022	C115371-3160
DBM 25S NMB OL3-FR022	C115371-3161
DCM 37P NMB OL3-FR022	C115371-3170
DCM 37S NMB OL3-FR022	C115371-3171
DDM 50P NMB OL3-FR022	C115371-3182
DDM 50S NMB OL3-FR022	C115371-3183
DEM 9P NMBZ-FR022	C115371-3300
DEM 9S NMBZ-FR022	C115371-3301
DAM 15P NMBZ-FR022	115371-3304
DAM 15S NMBZ-FR022	115371-3305
DBM 25P NMBZ-FR022	115371-3310
DBM 25S NMBZ-FR022	115371-3311
DCM 37P NMBZ-FR022	115371-3320
DCM 37S NMBZ-FR022	115371-3321
DDM 50P NMBZ-FR022	115371-3332
DDM 50S NMBZ-FR022	115371-3333

Option Y

Description ESA/ESCC	Part Number
340100101B DEMY 9P NMB OL3	C115371-5200
340100101B DEMY 9S NMB OL3	C115371-5201
340100101B DAMY 15P NMB OL3	C115371-5204
340100101B DAMY 15S NMB OL3	C115371-5205
340100101B DBMY 25P NMB OL3	C115371-5210
340100101B DBMY 25S NMB OL3	C115371-5211
340100101B DCMY 37P NMB OL3	C115371-5220
340100101B DCMY 37S NMB OL3	C115371-5221
340100101B DDMY 50P NMB OL3	C115371-5232
340100101B DDMY 50S NMB OL3	C115371-5233
340100101B DEMY 9P NMB Z	C115371-5350
340100101B DEMY 9S NMB Z	C115371-5351
340100101B DAMY 15P NMB Z	C115371-5354
340100101B DAMY 15S NMB Z	C115371-5355
340100101B DBMY 25P NMB Z	C115371-5360
340100101B DBMY 25S NMB Z	C115371-5361
340100101B DCMY 37P NMB Z	C115371-5370
340100101B DCMY 37S NMB Z	C115371-5371
340100101B DDMY 50P NMB Z	C115371-5382
340100101B DDMY 50S NMB Z	C115371-5383

Description FR022	Part Number
DEMY 9P NMB OL3-FR022	C115371-3200
DEMY 9S NMB OL3-FR022	C115371-3201
DAMY 15P NMB OL3-FR022	C115371-3204
DAMY 15S NMB OL3-FR022	C115371-3205
DBMY 25P NMB OL3-FR022	C115371-3210
DBMY 25S NMB OL3-FR022	C115371-3211
DCMY 37P NMB OL3-FR022	C115371-3220
DCMY 37S NMB OL3-FR022	C115371-3221
DDMY 50P NMB OL3-FR022	C115371-3232
DDMY 50S NMB OL3-FR022	C115371-3233
DEMY 9P NMBZ-FR022	C115371-3350
DEMY 9S NMBZ-FR022	C115371-3351
DAMY 15P NMBZ-FR022	C115371-3354
DAMY 15S NMBZ-FR022	C115371-3355
DBMY 25P NMBZ-FR022	C115371-3360
DBMY 25S NMBZ-FR022	C115371-3361
DCMY 37P NMBZ-FR022	C115371-3370
DCMY 37S NMBZ-FR022	C115371-3371
DDMY 50P NMBZ-FR022	C115371-3382
DDMY 50S NMBZ-FR022	C115371-3383



Dimensions are shown in mm (inch)
Dimensions subject to change

3401-001 D*M Standard Density

Option E

Description ESA/ESCC	Part Number
340100101B DEME 9P NMB OL3	C115371-5250
340100101B DEME 9S NMB OL3	C115371-5251
340100101B DAME 15P NMB OL3	C115371-5254
340100101B DAME 15S NMB OL3	C115371-5255
340100101B DBME 25P NMB OL3	C115371-5260
340100101B DBME 25S NMB OL3	C115371-5261
340100101B DCME 37P NMB OL3	C115371-5270
340100101B DCME 37S NMB OL3	C115371-5271
340100101B DDME 50P NMB OL3	C115371-5282
340100101B DDME 50S NMB OL3	C115371-5283
340100101B DEME 9P NMB Z	C115371-5400
340100101B DEME 9S NMB Z	C115371-5401
340100101B DAME 15P NMB Z	C115371-5404
340100101B DAME 15S NMB Z	C115371-5405
340100101B DBME 25P NMB Z	C115371-5410
340100101B DBME 25S NMB Z	C115371-5411
340100101B DCME 37P NMB Z	C115371-5420
340100101B DCME 37S NMB Z	C115371-5421
340100101B DDME 50P NMB Z	C115371-5432
340100101B DDME 50S NMB Z	C115371-5433

Description FR022	Part Number
DEME 9P NMB OL3-FR022	C115371-3250
DEME 9S NMB OL3-FR022	C115371-3251
DAME 15P NMB OL3-FR022	C115371-3254
DAME 15S NMB OL3-FR022	C115371-3255
DBME 25P NMB OL3-FR022	C115371-3260
DBME 25S NMB OL3-FR022	C115371-3261
DCME 37P NMB OL3-FR022	C115371-3270
DCME 37S NMB OL3-FR022	C115371-3271
DDME 50P NMB OL3-FR022	C115371-3282
DDME 50S NMB OL3-FR022	C115371-3283
DEME 9P NMBZ-FR022	C115371-3400
DEME 9S NMBZ-FR022	C115371-3401
DAME 15P NMBZ-FR022	C115371-3404
DAME 15S NMBZ-FR022	C115371-3405
DBME 25P NMBZ-FR022	C115371-3410
DBME 25S NMBZ-FR022	C115371-3411
DCME 37P NMBZ-FR022	C115371-3420
DCME 37S NMBZ-FR022	C115371-3421
DDME 50P NMBZ-FR022	C115371-3432
DDME 50S NMBZ-FR022	C115371-3433

3401-001 D*M Standard Density

90° Bent PCB solder Terminations / Without Brackets / US Footprint type P.

Specific Dimensions

Sizes E, A, B, C

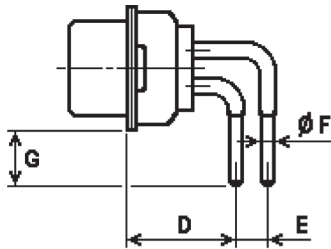

Size D

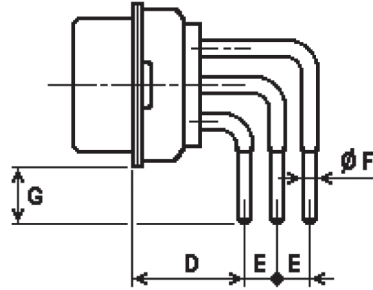

Termination Modifier	ØF ± 0,05 (.002)	E Typical
P	0,76 (.030)	2,84 (.112)

Contacts	Shell Size	D min	D max	G ± 0.37 (.015)	Pitch between contacts
Male	E	6,94 (.273)	7,44 (.293)	4,33 (.170)	2,74 (.108)
	A	6,94 (.273)	7,44 (.293)	4,33 (.170)	2,74 (.108)
	B	6,94 (.273)	7,44 (.293)	4,33 (.170)	2,76 (.109)
	C	6,94 (.273)	7,44 (.293)	4,33 (.170)	2,76 (.109)
	D	6,94 (.273)	7,44 (.293)	4,33 (.170)	2,76 (.109)
Female	E	6,94 (.273)	7,44 (.293)	4,33 (.170)	2,74 (.108)
	A	6,94 (.273)	7,44 (.293)	4,33 (.170)	2,74 (.108)
	B	6,94 (.273)	7,44 (.293)	4,33 (.170)	2,76 (.109)
	C	6,94 (.273)	7,44 (.293)	4,33 (.170)	2,76 (.109)
	D	6,94 (.273)	7,44 (.293)	4,33 (.170)	2,76 (.109)

Termination Modifier: P

For other termination modifier, consult factory

Weights

	Shell Size	Male Contact	Female Contact
Max Weight (grams) per contact		0,22 / 0,26 / 0,30	0,27 / 0,32 / 0,35
Max Weight (grams) of all contacts per size	E	2,18	2,68
	A	3,62	4,45
	B	6,02	7,40
	C	8,90	10,94
	D	13,00	15,66

3401-001 D*M Standard Density

Cross References

90° bent PCB (without brackets)

Standard

Description ESA/ESCC		Part Number
340100101B	DEM 9P NMB P	C115331-9016
340100101B	DEM 9S NMB P	C115331-9017
340100101B	DAM 15P NMB P	C115371-9020
340100101B	DAM 15S NMB P	C115371-9021
340100101B	DBM 25P NMB P	C115371-9026
340100101B	DBM 25S NMB P	C115371-9027
340100101B	DCM 37P NMB P	C115371-9036
340100101B	DCM 37S NMB P	C115371-9037
340100101B	DDM 50P NMB P	C115371-9048
340100101B	DDM 50S NMB P	C115371-9049

Description FR022	Part Number
DEM 9P NMBP-FR022	C115371-0000
DEM 9S NMBP-FR022	C115371-0001
DAM 15P NMBP-FR022	C115371-0004
DAM 15S NMBP-FR022	C115371-0005
DBM 25P NMBP-FR022	C115371-0010
DBM 25S NMBP-FR022	C115371-0011
DCM 37P NMBP-FR022	C115371-0020
DCM 37S NMBP-FR022	C115371-0021
DDM 50P NMBP-FR022	C115371-0032
DDM 50S NMBP-FR022	C115371-0033

Option Y

Description ESA/ESCC		Part Number
340100101B	DEMY 9P NMB P	C115331-9058
340100101B	DEMY 9S NMB P	C115331-9059
340100101B	DAMY 15P NMB P	C115371-9062
340100101B	DAMY 15S NMB P	C115371-9063
340100101B	DBMY 25P NMB P	C115371-9068
340100101B	DBMY 25S NMB P	C115371-9069
340100101B	DCMY 37P NMB P	C115371-9078
340100101B	DCMY 37S NMB P	C115371-9079
340100101B	DDMY 50P NMB P	C115371-9090
340100101B	DDMY 50S NMB P	C115371-9091

Description FR022	Part Number
DEMY 9P NMBP-FR022	C115371-0042
DEMY 9S NMBP-FR022	C115371-0043
DAMY 15P NMBP-FR022	C115371-0046
DAMY 15S NMBP-FR022	C115371-0047
DBMY 25P NMBP-FR022	C115371-0052
DBMY 25S NMBP-FR022	C115371-0053
DCMY 37P NMBP-FR022	C115371-0062
DCMY 37S NMBP-FR022	C115371-0063
DDMY 50P NMBP-FR022	C115371-0074
DDMY 50S NMBP-FR022	C115371-0075

Option E

Description ESA/ESCC		Part Number
340100101B	DEME 9P NMB P	C115331-9100
340100101B	DEME 9S NMB P	C115331-9101
340100101B	DAME 15P NMB P	C115371-9104
340100101B	DAME 15S NMB P	C115371-9105
340100101B	DBME 25P NMB P	C115371-9110
340100101B	DBME 25S NMB P	C115371-9111
340100101B	DCME 37P NMB P	C115371-9120
340100101B	DCME 37S NMB P	C115371-9121
340100101B	DDME 50P NMB P	C115371-9132
340100101B	DDME 50S NMB P	C115371-9133

Description FR022	Part Number
DEME 9P NMBP-FR022	C115371-0084
DEME 9S NMBP-FR022	C115371-0085
DAME 15P NMBP-FR022	C115371-0088
DAME 15S NMBP-FR022	C115371-0089
DBME 25P NMBP-FR022	C115371-0094
DBME 25S NMBP-FR022	C115371-0095
DCME 37P NMBP-FR022	C115371-0104
DCME 37S NMBP-FR022	C115371-0105
DDME 50P NMBP-FR022	C115371-0116
DDME 50S NMBP-FR022	C115371-0117



Dimensions are shown in mm (inch)
Dimensions subject to change

3401-001 D*M Standard Density

90° Bent PCB solder Terminations / Without Brackets / European Footprint type 1A0N – 1B0N – 2A0N – 2B0N

Specific Dimensions

Sizes E, A, B, C

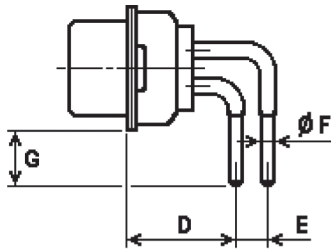

Size D

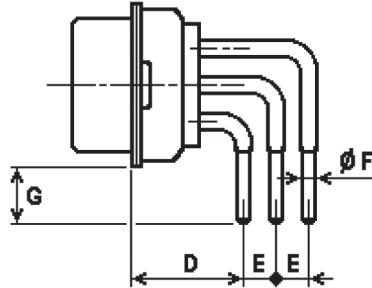

Termination Modifier	ØF ± 0,05 (.002)	E Typical
1A0N	0,60 (.024)	2,54 (.100)
1B0N	0,60 (.024)	2,84 (.112)
2A0N	0,76 (.030)	2,54 (.100)
2B0N	0,76 (.030)	2,84 (.112)

Contacts	Shell Size	D min	D max	G ± 0.30 (.012)	Pitch between contacts
Male	E	10,10 (.398)	10,30 (.406)	5,00 (.197)	2,74 (.108)
	A	10,10 (.398)	10,30 (.406)	5,00 (.197)	2,74 (.108)
	B	10,30 (.406)	10,50 (.413)	5,00 (.197)	2,76 (.109)
	C	10,30 (.406)	10,50 (.413)	5,00 (.197)	2,76 (.109)
	D	10,30 (.406)	10,50 (.413)	5,00 (.197)	2,76 (.109)
Female	E	10,10 (.398)	10,30 (.406)	5,00 (.197)	2,74 (.108)
	A	10,10 (.398)	10,30 (.406)	5,00 (.197)	2,74 (.108)
	B	10,10 (.398)	10,30 (.406)	5,00 (.197)	2,76 (.109)
	C	10,10 (.398)	10,30 (.406)	5,00 (.197)	2,76 (.109)
	D	10,10 (.398)	10,30 (.406)	5,00 (.197)	2,76 (.109)

Termination Modifier: 1A0N, 1B0N, 2A0N, 2B0N
For other termination modifier, consult factory

Weights

	Shell Size	Male Contact	Female Contact
Max Weight (grams) per contact		0,24 / 0,28 / 0,32	0,29 / 0,34 / 0,37
Max Weight (grams) of all contacts per size	E	2,36	2,86
	A	3,92	4,75
	B	6,52	7,90
	C	9,64	11,68
	D	14,00	16,66

3401-001 D*M Standard Density

Cross References

90° bent PCB (without brackets)

Standard

Description ESA/ESCC	Part Number
340100101B DEM 9P NMB 1AON	C115371-5600
340100101B DEM 9S NMB 1AON	C115371-5601
340100101B DAM 15P NMB 1AON	C115371-5604
340100101B DAM 15S NMB 1AON	C115371-5605
340100101B DBM 25P NMB 1AON	C115371-5610
340100101B DBM 25S NMB 1AON	C115371-5611
340100101B DCM 37P NMB 1AON	C115371-5620
340100101B DCM 37S NMB 1AON	C115371-5621
340100101B DDM 50P NMB 1AON	C115371-5632
340100101B DDM 50S NMB 1AON	C115371-5633
340100101B DEM 9P NMB 1BON	C115371-5750
340100101B DEM 9S NMB 1BON	C115371-5751
340100101B DAM 15P NMB 1BON	C115371-5754
340100101B DAM 15S NMB 1BON	C115371-5755
340100101B DBM 25P NMB 1BON	C115371-5760
340100101B DBM 25S NMB 1BON	C115371-5761
340100101B DCM 37P NMB 1BON	C115371-5770
340100101B DCM 37S NMB 1BON	C115371-5771
340100101B DDM 50P NMB 1BON	C115371-5782
340100101B DDM 50S NMB 1BON	C115371-5783
340100101B DEM 9P NMB 2AON	C115371-5900
340100101B DEM 9S NMB 2AON	C115371-5901
340100101B DAM 15P NMB 2AON	C115371-5904
340100101B DAM 15S NMB 2AON	C115371-5905
340100101B DBM 25P NMB 2AON	C115371-5910
340100101B DBM 25S NMB 2AON	C115371-5911
340100101B DCM 37P NMB 2AON	C115371-5920
340100101B DCM 37S NMB 2AON	C115371-5921
340100101B DDM 50P NMB 2AON	C115371-5932
340100101B DDM 50S NMB 2AON	C115371-5933
340100101B DEM 9P NMB 2BON	C115371-6050
340100101B DEM 9S NMB 2BON	C115371-6051
340100101B DAM 15P NMB 2BON	C115371-6054
340100101B DAM 15S NMB 2BON	C115371-6055
340100101B DBM 25P NMB 2BON	C115371-6060
340100101B DBM 25S NMB 2BON	C115371-6061
340100101B DCM 37P NMB 2BON	C115371-6070
340100101B DCM 37S NMB 2BON	C115371-6071
340100101B DDM 50P NMB 2BON	C115371-6082
340100101B DDM 50S NMB 2BON	C115371-6083

Description FR022	Part Number
DEM 9P NMB 1AON-FR022	C115371-3600
DEM 9S NMB 1AON-FR022	C115371-3601
DAM 15P NMB 1AON-FR022	C115371-3604
DAM 15S NMB 1AON-FR022	C115371-3605
DBM 25P NMB 1AON-FR022	C115371-3610
DBM 25S NMB 1AON-FR022	C115371-3611
DCM 37P NMB 1AON-FR022	C115371-3620
DCM 37S NMB 1AON-FR022	C115371-3621
DDM 50P NMB 1AON-FR022	C115371-3632
DDM 50S NMB 1AON-FR022	C115371-3633
DEM 9P NMB 1BON-FR022	C115371-3750
DEM 9S NMB 1BON-FR022	C115371-3751
DAM 15P NMB 1BON-FR022	C115371-3754
DAM 15S NMB 1BON-FR022	C115371-3755
DBM 25P NMB 1BON-FR022	C115371-3760
DBM 25S NMB 1BON-FR022	C115371-3761
DCM 37P NMB 1BON-FR022	C115371-3770
DCM 37S NMB 1BON-FR022	C115371-3771
DDM 50P NMB 1BON-FR022	C115371-3782
DDM 50S NMB 1BON-FR022	C115371-3783
DEM 9P NMB 2AON-FR022	C115371-3900
DEM 9S NMB 2AON-FR022	C115371-3901
DAM 15P NMB 2AON-FR022	C115371-3904
DAM 15S NMB 2AON-FR022	C115371-3905
DBM 25P NMB 2AON-FR022	C115371-3910
DBM 25S NMB 2AON-FR022	C115371-3911
DCM 37P NMB 2AON-FR022	C115371-3920
DCM 37S NMB 2AON-FR022	C115371-3921
DDM 50P NMB 2AON-FR022	C115371-3932
DDM 50S NMB 2AON-FR022	C115371-3933
DEM 9P NMB 2BON-FR022	C115371-4050
DEM 9S NMB 2BON-FR022	C115371-4051
DAM 15P NMB 2BON-FR022	C115371-4054
DAM 15S NMB 2BON-FR022	C115371-4055
DBM 25P NMB 2BON-FR022	C115371-4060
DBM 25S NMB 2BON-FR022	C115371-4061
DCM 37P NMB 2BON-FR022	C115371-4070
DCM 37S NMB 2BON-FR022	C115371-4071
DDM 50P NMB 2BON-FR022	C115371-4082
DDM 50S NMB 2BON-FR022	C115371-4083



Dimensions are shown in mm (inch)
Dimensions subject to change

3401-001 D*M Standard Density

Option Y

Description ESA/ESCC		Part Number
340100101B	DEMY 9P NMB 1AON	C115371-5650
340100101B	DEMY 9S NMB 1AON	C115371-5651
340100101B	DAMY 15P NMB 1AON	C115371-5654
340100101B	DAMY 15S NMB 1AON	C115371-5655
340100101B	DBMY 25P NMB 1AON	C115371-5660
340100101B	DBMY 25S NMB 1AON	C115371-5661
340100101B	DCMY 37P NMB 1AON	C115371-5670
340100101B	DCMY 37S NMB 1AON	C115371-5671
340100101B	DDMY 50P NMB 1AON	C115371-5682
340100101B	DDMY 50S NMB 1AON	C115371-5683
340100101B	DEMY 9P NMB 1BON	C115371-5800
340100101B	DEMY 9S NMB 1BON	C115371-5801
340100101B	DAMY 15P NMB 1BON	C115371-5804
340100101B	DAMY 15S NMB 1BON	C115371-5805
340100101B	DBMY 25P NMB 1BON	C115371-5810
340100101B	DBMY 25S NMB 1BON	C115371-5811
340100101B	DCMY 37P NMB 1BON	C115371-5820
340100101B	DCMY 37S NMB 1BON	C115371-5821
340100101B	DDMY 50P NMB 1BON	C115371-5832
340100101B	DDMY 50S NMB 1BON	C115371-5833
340100101B	DEMY 9P NMB 2AON	C115371-5950
340100101B	DEMY 9S NMB 2AON	C115371-5951
340100101B	DAMY 15P NMB 2AON	C115371-5954
340100101B	DAMY 15S NMB 2AON	C115371-5955
340100101B	DBMY 25P NMB 2AON	C115371-5960
340100101B	DBMY 25S NMB 2AON	C115371-5961
340100101B	DCMY 37P NMB 2AON	C115371-5970
340100101B	DCMY 37S NMB 2AON	C115371-5971
340100101B	DDMY 50P NMB 2AON	C115371-5982
340100101B	DDMY 50S NMB 2AON	C115371-5983
340100101B	DEMY 9P NMB 2BON	C115371-6100
340100101B	DEMY 9S NMB 2BON	C115371-6101
340100101B	DAMY 15P NMB 2BON	C115371-6104
340100101B	DAMY 15S NMB 2BON	C115371-6105
340100101B	DBMY 25P NMB 2BON	C115371-6110
340100101B	DBMY 25S NMB 2BON	C115371-6111
340100101B	DCMY 37P NMB 2BON	C115371-6120
340100101B	DCMY 37S NMB 2BON	C115371-6121
340100101B	DDMY 50P NMB 2BON	C115371-6132
340100101B	DDMY 50S NMB 2BON	C115371-6133

Description FR022		Part Number
DEMY 9P NMB 1AON-FR022		C115371-3650
DEMY 9S NMB 1AON-FR022		C115371-3651
DAMY 15P NMB 1AON-FR022		C115371-3654
DAMY 15S NMB 1AON-FR022		C115371-3655
DBMY 25P NMB 1AON-FR022		C115371-3660
DBMY 25S NMB 1AON-FR022		C115371-3661
DCMY 37P NMB 1AON-FR022		C115371-3670
DCMY 37S NMB 1AON-FR022		C115371-3671
DDMY 50P NMB 1AON-FR022		C115371-3682
DDMY 50S NMB 1AON-FR022		C115371-3683
DEMY 9P NMB 1BON-FR022		C115371-3800
DEMY 9S NMB 1BON-FR022		C115371-3801
DAMY 15P NMB 1BON-FR022		C115371-3804
DAMY 15S NMB 1BON-FR022		C115371-3805
DBMY 25P NMB 1BON-FR022		C115371-3810
DBMY 25S NMB 1BON-FR022		C115371-3811
DCMY 37P NMB 1BON-FR022		C115371-3820
DCMY 37S NMB 1BON-FR022		C115371-3821
DDMY 50P NMB 1BON-FR022		C115371-3832
DDMY 50S NMB 1BON-FR022		C115371-3833
DEMY 9P NMB 2AON-FR022		C115371-3950
DEMY 9S NMB 2AON-FR022		C115371-3951
DAMY 15P NMB 2AON-FR022		C115371-3954
DAMY 15S NMB 2AON-FR022		C115371-3955
DBMY 25P NMB 2AON-FR022		C115371-3960
DBMY 25S NMB 2AON-FR022		C115371-3961
DCMY 37P NMB 2AON-FR022		C115371-3970
DCMY 37S NMB 2AON-FR022		C115371-3971
DDMY 50P NMB 2AON-FR022		C115371-3982
DDMY 50S NMB 2AON-FR022		C115371-3983
DEMY 9P NMB 2BON-FR022		C115371-4100
DEMY 9S NMB 2BON-FR022		C115371-4101
DAMY 15P NMB 2BON-FR022		C115371-4104
DAMY 15S NMB 2BON-FR022		C115371-4105
DBMY 25P NMB 2BON-FR022		C115371-4110
DBMY 25S NMB 2BON-FR022		C115371-4111
DCMY 37P NMB 2BON-FR022		C115371-4120
DCMY 37S NMB 2BON-FR022		C115371-4121
DDMY 50P NMB 2BON-FR022		C115371-4132
DDMY 50S NMB 2BON-FR022		C115371-4133



Dimensions are shown in mm (inch)
Dimensions subject to change

3401-001 D*M Standard Density

Option E

Description ESA/ESCC		Part Number
340100101B	DEME 9P NMB 1AON	C115371-5700
340100101B	DEME 9S NMB 1AON	C115371-5701
340100101B	DAME 15P NMB 1AON	C115371-5704
340100101B	DAME 15S NMB 1AON	C115371-5705
340100101B	DBME 25P NMB 1AON	C115371-5710
340100101B	DBME 25S NMB 1AON	C115371-5711
340100101B	DCME 37P NMB 1AON	C115371-5720
340100101B	DCME 37S NMB 1AON	C115371-5721
340100101B	DDME 50P NMB 1AON	C115371-5732
340100101B	DDME 50S NMB 1AON	C115371-5733
340100101B	DEME 9P NMB 1BON	C115371-5850
340100101B	DEME 9S NMB 1BON	C115371-5851
340100101B	DAME 15P NMB 1BON	C115371-5854
340100101B	DAME 15S NMB 1BON	C115371-5855
340100101B	DBME 25P NMB 1BON	C115371-5860
340100101B	DBME 25S NMB 1BON	C115371-5861
340100101B	DCME 37P NMB 1BON	C115371-5870
340100101B	DCME 37S NMB 1BON	C115371-5871
340100101B	DDME 50P NMB 1BON	C115371-5882
340100101B	DDME 50S NMB 1BON	C115371-5883
340100101B	DEME 9P NMB 2AON	C115371-6000
340100101B	DEME 9S NMB 2AON	C115371-6001
340100101B	DAME 15P NMB 2AON	C115371-6004
340100101B	DAME 15S NMB 2AON	C115371-6005
340100101B	DBME 25P NMB 2AON	C115371-6010
340100101B	DBME 25S NMB 2AON	C115371-6011
340100101B	DCME 37P NMB 2AON	C115371-6020
340100101B	DCME 37S NMB 2AON	C115371-6021
340100101B	DDME 50P NMB 2AON	C115371-6032
340100101B	DDME 50S NMB 2AON	C115371-6033
340100101B	DEME 9P NMB 2BON	C115371-6150
340100101B	DEME 9S NMB 2BON	C115371-6151
340100101B	DAME 15P NMB 2BON	C115371-6154
340100101B	DAME 15S NMB 2BON	C115371-6155
340100101B	DBME 25P NMB 2BON	C115371-6160
340100101B	DBME 25S NMB 2BON	C115371-6161
340100101B	DCME 37P NMB 2BON	C115371-6170
340100101B	DCME 37S NMB 2BON	C115371-6171
340100101B	DDME 50P NMB 2BON	C115371-6182
340100101B	DDME 50S NMB 2BON	C115371-6183

Description FR022		Part Number
DEME 9P NMB 1AON-FR022		C115371-3700
DEME 9S NMB 1AON-FR022		C115371-3701
DAME 15P NMB 1AON-FR022		C115371-3704
DAME 15S NMB 1AON-FR022		C115371-3705
DBME 25P NMB 1AON-FR022		C115371-3710
DBME 25S NMB 1AON-FR022		C115371-3711
DCME 37P NMB 1AON-FR022		C115371-3720
DCME 37S NMB 1AON-FR022		C115371-3721
DDME 50P NMB 1AON-FR022		C115371-3732
DDME 50S NMB 1AON-FR022		C115371-3733
DEME 9P NMB 1BON-FR022		C115371-3850
DEME 9S NMB 1BON-FR022		C115371-3851
DAME 15P NMB 1BON-FR022		C115371-3854
DAME 15S NMB 1BON-FR022		C115371-3855
DBME 25P NMB 1BON-FR022		C115371-3860
DBME 25S NMB 1BON-FR022		C115371-3861
DCME 37P NMB 1BON-FR022		C115371-3870
DCME 37S NMB 1BON-FR022		C115371-3871
DDME 50P NMB 1BON-FR022		C115371-3882
DDME 50S NMB 1BON-FR022		C115371-3883
DEME 9P NMB 2AON-FR022		C115371-4000
DEME 9S NMB 2AON-FR022		C115371-4001
DAME 15P NMB 2AON-FR022		C115371-4004
DAME 15S NMB 2AON-FR022		C115371-4005
DBME 25P NMB 2AON-FR022		C115371-4010
DBME 25S NMB 2AON-FR022		C115371-4011
DCME 37P NMB 2AON-FR022		C115371-4020
DCME 37S NMB 2AON-FR022		C115371-4021
DDME 50P NMB 2AON-FR022		C115371-4032
DDME 50S NMB 2AON-FR022		C115371-4033
DEME 9P NMB 2BON-FR022		C115371-4150
DEME 9S NMB 2BON-FR022		C115371-4151
DAME 15P NMB 2BON-FR022		C115371-4154
DAME 15S NMB 2BON-FR022		C115371-4155
DBME 25P NMB 2BON-FR022		C115371-4160
DBME 25S NMB 2BON-FR022		C115371-4161
DCME 37P NMB 2BON-FR022		C115371-4170
DCME 37S NMB 2BON-FR022		C115371-4171
DDME 50P NMB 2BON-FR022		C115371-4182
DDME 50S NMB 2BON-FR022		C115371-4183



Dimensions are shown in mm (inch)
Dimensions subject to change

3401-001 D*M Standard Density

90° Bent PCB solder Terminations / With Brackets / European Footprint Type 1A7N – 1A9N – 1B7N – 1B9N – 2A7N – 2A9N – 2B7N – 2B9N

Specific Dimensions

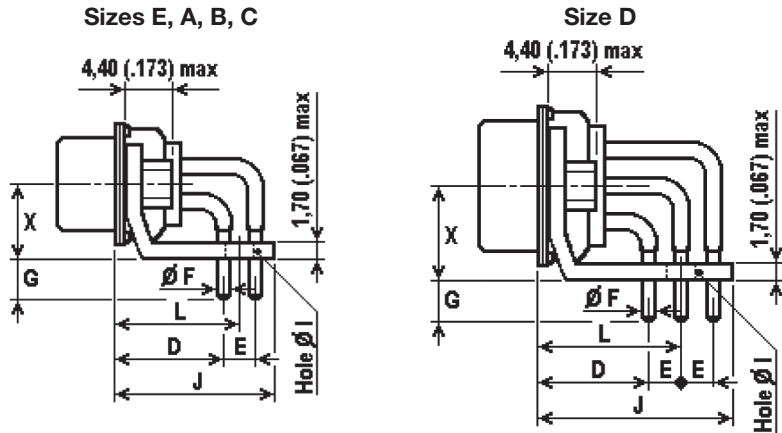

Termination Modifier	ØF ± 0,05 (.002)	E Typical
1A7N / 1A9N	0,60 (.024)	2,54 (.100)
1B7N / 1B9N	0,60 (.024)	2,84 (.112)
2A7N / 2A9N	0,76 (.030)	2,54 (.100)
2B7N / 2B9N	0,76 (.030)	2,84 (.112)

2 pieces metal brackets:

«7N»: fixed with captive nuts 4-40 UNC-2B

«9N»: fixed with captive nuts M3

Hole Ø I: 3,22 (.127) ± 0,10 (.004)

Bracket width (onto PCB):

Shell sizes E, A, B, C: 6,10 (.240) max

Shell size D: 5,50 (.217) max

Contacts	Shell Size	D min	D max	G ± 0,40 (.016)	J max	L Typical	X ± 0,15 (.006)	Pitch between contacts
Male	E	10,10 (.398)	10,30 (.406)	4,00 (.157)	15,60 (.614)	11,52 (.454)	7,35 (.289)	2,74 (.108)
	A	10,10 (.398)	10,30 (.406)	4,00 (.157)	15,60 (.614)	11,52 (.454)	7,35 (.289)	2,74 (.108)
	B	10,30 (.406)	10,50 (.413)	4,00 (.157)	15,80 (.622)	11,74 (.462)	7,35 (.289)	2,76 (.109)
	C	10,30 (.406)	10,50 (.413)	4,00 (.157)	15,80 (.622)	11,74 (.462)	7,35 (.289)	2,76 (.109)
	D	10,30 (.406)	10,50 (.413)	4,00 (.157)	17,70 (.697)	13,16 (.518)	8,70 (.343)	2,76 (.109)
Female	E	10,10 (.398)	10,30 (.406)	4,00 (.157)	15,60 (.614)	11,52 (.454)	7,35 (.289)	2,74 (.108)
	A	10,10 (.398)	10,30 (.406)	4,00 (.157)	15,60 (.614)	11,52 (.454)	7,35 (.289)	2,74 (.108)
	B	10,10 (.398)	10,30 (.406)	4,00 (.157)	15,60 (.614)	11,52 (.454)	7,35 (.289)	2,76 (.109)
	C	10,10 (.398)	10,30 (.406)	4,00 (.157)	15,60 (.614)	11,52 (.454)	7,35 (.289)	2,76 (.109)
	D	10,10 (.398)	10,30 (.406)	4,00 (.157)	17,50 (.689)	12,94 (.509)	8,70 (.343)	2,76 (.109)

Termination Modifier: 1A7N, 1B7N, 1A9N, 1B9N, 2A7N, 2B7N, 2A9N, 2B9N

For other termination modifier, consult factory

Weights

	Shell Size	Male Contact	Female Contact
Max Weight (grams) per contact		0,24 / 0,28 / 0,32	0,29 / 0,34 / 0,37
Max Weight (grams) of all contacts per size	E	2,36	2,86
	A	3,92	4,75
	B	6,52	7,90
	C	9,64	11,68
	D	14,00	16,66
Max Weight (grams) of Brackets & Nuts	Sizes E, A, B, C	3,10	3,10
	Size D	3,80	3,80

3401-001 D*M Standard Density

Cross references

90° bent PCB (with brackets)

Standard

Description ESA/ESCC	Part Number
340100101B DEM 9P NMB 1A7N	C115371-6200
340100101B DEM 9S NMB 1A7N	C115371-6201
340100101B DAM 15P NMB 1A7N	C115371-6204
340100101B DAM 15S NMB 1A7N	C115371-6205
340100101B DBM 25P NMB 1A7N	C115371-6210
340100101B DBM 25S NMB 1A7N	C115371-6211
340100101B DCM 37P NMB 1A7N	C115371-6220
340100101B DCM 37S NMB 1A7N	C115371-6221
340100101B DDM 50P NMB 1A7N	C115371-6232
340100101B DDM 50S NMB 1A7N	C115371-6233
340100101B DEM 9P NMB 1B7N	C115371-6250
340100101B DEM 9S NMB 1B7N	C115371-6251
340100101B DAM 15P NMB 1B7N	C115371-6254
340100101B DAM 15S NMB 1B7N	C115371-6255
340100101B DBM 25P NMB 1B7N	C115371-6260
340100101B DBM 25S NMB 1B7N	C115371-6261
340100101B DCM 37P NMB 1B7N	C115371-6270
340100101B DCM 37S NMB 1B7N	C115371-6271
340100101B DDM 50P NMB 1B7N	C115371-6282
340100101B DDM 50S NMB 1B7N	C115371-6283
340100101B DEM 9P NMB 1A9N	C115371-6300
340100101B DEM 9S NMB 1A9N	C115371-6301
340100101B DAM 15P NMB 1A9N	C115371-6304
340100101B DAM 15S NMB 1A9N	C115371-6305
340100101B DBM 25P NMB 1A9N	C115371-6310
340100101B DBM 25S NMB 1A9N	C115371-6311
340100101B DCM 37P NMB 1A9N	C115371-6320
340100101B DCM 37S NMB 1A9N	C115371-6321
340100101B DDM 50P NMB 1A9N	C115371-6332
340100101B DDM 50S NMB 1A9N	C115371-6333
340100101B DEM 9P NMB 1B9N	C115371-6350
340100101B DEM 9S NMB 1B9N	C115371-6351
340100101B DAM 15P NMB 1B9N	C115371-6354
340100101B DAM 15S NMB 1B9N	C115371-6355
340100101B DBM 25P NMB 1B9N	C115371-6360
340100101B DBM 25S NMB 1B9N	C115371-6361
340100101B DCM 37P NMB 1B9N	C115371-6370
340100101B DCM 37S NMB 1B9N	C115371-6371
340100101B DDM 50P NMB 1B9N	C115371-6382
340100101B DDM 50S NMB 1B9N	C115371-6383
340100101B DEM 9P NMB 2A7N	C115371-6400
340100101B DEM 9S NMB 2A7N	C115371-6401
340100101B DAM 15P NMB 2A7N	C115371-6404
340100101B DAM 15S NMB 2A7N	C115371-6405
340100101B DBM 25P NMB 2A7N	C115371-6410
340100101B DBM 25S NMB 2A7N	C115371-6411
340100101B DCM 37P NMB 2A7N	C115371-6420

Description FR022	Part Number
DEM 9P NMB 1A7N-FR022	C115371-4200
DEM 9S NMB 1A7N-FR022	C115371-4201
DAM 15P NMB 1A7N-FR022	C115371-4204
DAM 15S NMB 1A7N-FR022	C115371-4205
DBM 25P NMB 1A7N-FR022	C115371-4210
DBM 25S NMB 1A7N-FR022	C115371-4211
DCM 37P NMB 1A7N-FR022	C115371-4220
DCM 37S NMB 1A7N-FR022	C115371-4221
DDM 50P NMB 1A7N-FR022	C115371-4232
DDM 50S NMB 1A7N-FR022	C115371-4233
DEM 9P NMB 1B7N-FR022	C115371-4250
DEM 9S NMB 1B7N-FR022	C115371-4251
DAM 15P NMB 1B7N-FR022	C115371-4254
DAM 15S NMB 1B7N-FR022	C115371-4255
DBM 25P NMB 1B7N-FR022	C115371-4260
DBM 25S NMB 1B7N-FR022	C115371-4261
DCM 37P NMB 1B7N-FR022	C115371-4270
DCM 37S NMB 1B7N-FR022	C115371-4271
DDM 50P NMB 1B7N-FR022	C115371-4282
DDM 50S NMB 1B7N-FR022	C115371-4283
DEM 9P NMB 1A9N-FR022	C115371-4300
DEM 9S NMB 1A9N-FR022	C115371-4301
DAM 15P NMB 1A9N-FR022	C115371-4304
DAM 15S NMB 1A9N-FR022	C115371-4305
DBM 25P NMB 1A9N-FR022	C115371-4310
DBM 25S NMB 1A9N-FR022	C115371-4311
DCM 37P NMB 1A9N-FR022	C115371-4320
DCM 37S NMB 1A9N-FR022	C115371-4321
DDM 50P NMB 1A9N-FR022	C115371-4332
DDM 50S NMB 1A9N-FR022	C115371-4333
DEM 9P NMB 1B9N-FR022	C115371-4350
DEM 9S NMB 1B9N-FR022	C115371-4351
DAM 15P NMB 1B9N-FR022	C115371-4354
DAM 15S NMB 1B9N-FR022	C115371-4355
DBM 25P NMB 1B9N-FR022	C115371-4360
DBM 25S NMB 1B9N-FR022	C115371-4361
DCM 37P NMB 1B9N-FR022	C115371-4370
DCM 37S NMB 1B9N-FR022	C115371-4371
DDM 50P NMB 1B9N-FR022	C115371-4382
DDM 50S NMB 1B9N-FR022	C115371-4383
DEM 9P NMB 2A7N-FR022	C115371-4400
DEM 9S NMB 2A7N-FR022	C115371-4401
DAM 15P NMB 2A7N-FR022	C115371-4404
DAM 15S NMB 2A7N-FR022	C115371-4405
DBM 25P NMB 2A7N-FR022	C115371-4410
DBM 25S NMB 2A7N-FR022	C115371-4411
DCM 37P NMB 2A7N-FR022	C115371-4420



Dimensions are shown in mm (inch)
Dimensions subject to change

3401-001 D*M Standard Density

Description ESA/ESCC		Part Number
340100101B	DCM 37S NMB 2A7N	C115371-6421
340100101B	DDM 50P NMB 2A7N	C115371-6432
340100101B	DDM 50S NMB 2A7N	C115371-6433
340100101B	DEM 9P NMB 2B7N	C115371-6450
340100101B	DEM 9S NMB 2B7N	C115371-6451
340100101B	DAM 15P NMB 2B7N	C115371-6454
340100101B	DAM 15S NMB 2B7N	C115371-6455
340100101B	DBM 25P NMB 2B7N	C115371-6460
340100101B	DBM 25S NMB 2B7N	C115371-6461
340100101B	DCM 37P NMB 2B7N	C115371-6470
340100101B	DCM 37S NMB 2B7N	C115371-6471
340100101B	DDM 50P NMB 2B7N	C115371-6482
340100101B	DDM 50S NMB 2B7N	C115371-6483
340100101B	DEM 9P NMB 2A9N	C115371-6500
340100101B	DEM 9S NMB 2A9N	C115371-6501
340100101B	DAM 15P NMB 2A9N	C115371-6504
340100101B	DAM 15S NMB 2A9N	C115371-6505
340100101B	DBM 25P NMB 2A9N	C115371-6510
340100101B	DBM 25S NMB 2A9N	C115371-6511
340100101B	DCM 37P NMB 2A9N	C115371-6520
340100101B	DCM 37S NMB 2A9N	C115371-6521
340100101B	DDM 50P NMB 2A9N	C115371-6532
340100101B	DDM 50S NMB 2A9N	C115371-6533
340100101B	DEM 9P NMB 2B9N	C115371-6550
340100101B	DEM 9S NMB 2B9N	C115371-6551
340100101B	DAM 15P NMB 2B9N	C115371-6554
340100101B	DAM 15S NMB 2B9N	C115371-6555
340100101B	DBM 25P NMB 2B9N	C115371-6560
340100101B	DBM 25S NMB 2B9N	C115371-6561
340100101B	DCM 37P NMB 2B9N	C115371-6570
340100101B	DCM 37S NMB 2B9N	C115371-6571
340100101B	DDM 50P NMB 2B9N	C115371-6582
340100101B	DDM 50S NMB 2B9N	C115371-6583

Description FR022		Part Number
DCM 37S NMB 2A7N-FR022		C115371-4421
DDM 50P NMB 2A7N-FR022		C115371-4432
DDM 50S NMB 2A7N-FR022		C115371-4433
DEM 9P NMB 2B7N-FR022		C115371-4450
DEM 9S NMB 2B7N-FR022		C115371-4451
DAM 15P NMB 2B7N-FR022		C115371-4454
DAM 15S NMB 2B7N-FR022		C115371-4455
DBM 25P NMB 2B7N-FR022		C115371-4460
DBM 25S NMB 2B7N-FR022		C115371-4461
DCM 37P NMB 2B7N-FR022		C115371-4470
DCM 37S NMB 2B7N-FR022		C115371-4471
DDM 50P NMB 2B7N-FR022		C115371-4482
DDM 50S NMB 2B7N-FR022		C115371-4483
DEM 9P NMB 2A9N-FR022		C115371-4500
DEM 9S NMB 2A9N-FR022		C115371-4501
DAM 15P NMB 2A9N-FR022		C115371-4504
DAM 15S NMB 2A9N-FR022		C115371-4505
DBM 25P NMB 2A9N-FR022		C115371-4510
DBM 25S NMB 2A9N-FR022		C115371-4511
DCM 37P NMB 2A9N-FR022		C115371-4520
DCM 37S NMB 2A9N-FR022		C115371-4521
DDM 50P NMB 2A9N-FR022		C115371-4532
DDM 50S NMB 2A9N-FR022		C115371-4533
DEM 9P NMB 2B9N-FR022		C115371-4550
DEM 9S NMB 2B9N-FR022		C115371-4551
DAM 15P NMB 2B9N-FR022		C115371-4554
DAM 15S NMB 2B9N-FR022		C115371-4555
DBM 25P NMB 2B9N-FR022		C115371-4560
DBM 25S NMB 2B9N-FR022		C115371-4561
DCM 37P NMB 2B9N-FR022		C115371-4570
DCM 37S NMB 2B9N-FR022		C115371-4571
DDM 50P NMB 2B9N-FR022		C115371-4582
DDM 50S NMB 2B9N-FR022		C115371-4583

3401-001 D*M Standard Density

90° Bent PCB solder Terminations / With Monoblock Plastic Brackets / U.S. Footprint type D and L

Specific Dimensions

Sizes E, A, B, C

Size D

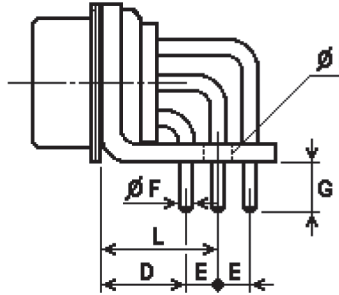
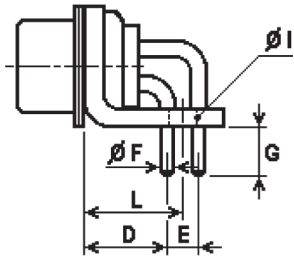

Termination Modifier	ØF ± 0,05 (.002)	G ± 0,37 (.015)
D	0,76 (.030)	3,21 (.126)
L	0,76 (.030)	4,33 (.170)

1 piece plastic bracket
Hole Ø I: 3,05 (.120) ± 0,13 (.005)

Contacts	Shell Size	D min	D max	E Typical	L ± 0,25 (.010)	Pitch between contacts
Male	E	6,94 (.273)	7,44 (.293)	2,84 (.112)	8,60 (.339)	2,74 (.108)
	A	6,94 (.273)	7,44 (.293)	2,84 (.112)	8,60 (.339)	2,74 (.108)
	B	6,94 (.273)	7,44 (.293)	2,84 (.112)	8,60 (.339)	2,76 (.109)
	C	6,94 (.273)	7,44 (.293)	2,84 (.112)	8,60 (.339)	2,76 (.109)
Female	D	6,94 (.273)	7,44 (.293)	2,84 (.112)	10.02 (.394)	2,76 (.109)
	E	6,94 (.273)	7,44 (.293)	2,84 (.112)	8,60 (.339)	2,74 (.108)
	A	6,94 (.273)	7,44 (.293)	2,84 (.112)	8,60 (.339)	2,74 (.108)
	B	6,94 (.273)	7,44 (.293)	2,84 (.112)	8,60 (.339)	2,76 (.109)
	C	6,94 (.273)	7,44 (.293)	2,84 (.112)	8,60 (.339)	2,76 (.109)
	D	6,94 (.273)	7,44 (.293)	2,84 (.112)	10.02 (.394)	2,76 (.109)

Termination Modifier: D, L

For other termination modifier, consult factory

Weights

	Shell Size	Male Contact	Female Contact	Plastic Bracket
Max Weight (grams) per contact		0,22 / 0,96 / 0,30	0,27 / 0,32 / 0,35	
Max Weight (grams) of all contacts per size	E	2,18	2,68	1,49
	A	3,62	4,45	1,72
	B	6,02	7,40	2,05
	C	8,90	10,94	2,41
	D	13,00	15,66	3,22

3401-001 D*M Standard Density

90° Bent PCB solder Terminations / With Brackets / US Footprint Type L7 – L9

Specific Dimensions

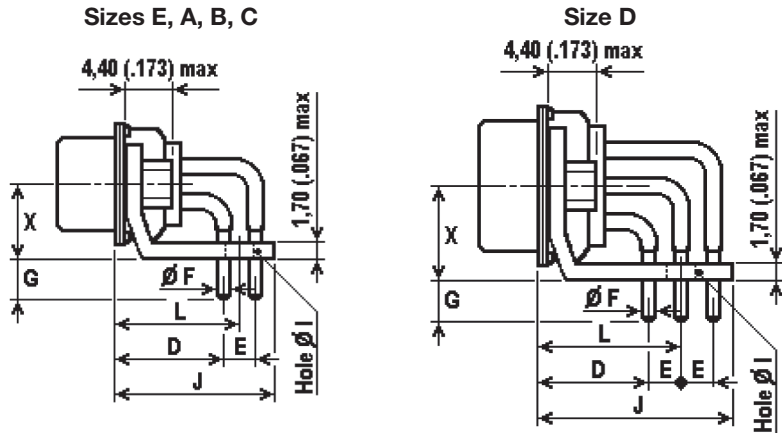

Termination Modifier	ØF ± 0,05 (.002)	E Typical
L7	0,76 (.030)	2,84 (.112)
L9	0,76 (.030)	2,84 (.112)

2 pieces metal brackets:

“L7”: fixed with captive nuts 4-40 UNC-2B

“L9”: fixed with captive nuts M3

Hole Ø I: 3,22 (.127) ± 0,10 (.004)

Bracket width (onto PCB):

Shell sizes E, A, B, C, D: 5,70 (.224) max

Contacts	Shell Size	D min	D max	G ± 0.37 (.015)	J max	L Typical	X ± 0,15 (.006)	Pitch between contacts
Male	E	6,94 (.273)	7,44 (.293)	4,33 (.170)	11,80 (.464)	8,60 (.339)	6,35 (.250)	2,74 (.108)
	A	6,94 (.273)	7,44 (.293)	4,33 (.170)	11,80 (.464)	8,60 (.339)	6,35 (.250)	2,74 (.108)
	B	6,94 (.273)	7,44 (.293)	4,33 (.170)	11,80 (.464)	8,60 (.339)	6,35 (.250)	2,76 (.109)
	C	6,94 (.273)	7,44 (.293)	4,33 (.170)	11,80 (.464)	8,60 (.339)	6,35 (.250)	2,76 (.109)
	D	6,94 (.273)	7,44 (.293)	4,33 (.170)	11,80 (.464)	10,05 (.396)	7,75 (.305)	2,76 (.109)
Female	E	6,94 (.273)	7,44 (.293)	4,33 (.170)	11,80 (.464)	8,60 (.339)	6,35 (.250)	2,74 (.108)
	A	6,94 (.273)	7,44 (.293)	4,33 (.170)	11,80 (.464)	8,60 (.339)	6,35 (.250)	2,74 (.108)
	B	6,94 (.273)	7,44 (.293)	4,33 (.170)	11,80 (.464)	8,60 (.339)	6,35 (.250)	2,76 (.109)
	C	6,94 (.273)	7,44 (.293)	4,33 (.170)	11,80 (.464)	8,60 (.339)	6,35 (.250)	2,76 (.109)
	D	6,94 (.273)	7,44 (.293)	4,33 (.170)	11,80 (.464)	10,05 (.396)	7,75 (.305)	2,76 (.109)

Termination Modifier: L7 / L9

For other termination modifier, consult factory

Weights

	Shell Size	Male Contact	Female Contact
Max Weight (grams) per contact		0,24 / 0,28 / 0,32	0,29 / 0,34 / 0,37
Max Weight (grams) of all contacts per size	E	2,36	2,86
	A	3,92	4,75
	B	6,52	7,90
	C	9,64	11,68
	D	14,00	16,66
Max Weight (grams) of Brackets & Nuts	E, A, B, C	3,00	3,00
	D	3,60	3,60

3401-001 D*M Standard Density

Cross references

90° bent PCB (with brackets)

Standard

L7

Description ESA/ESCC		Part Number	Description FR022		Part Number
340100101B	DEM 9P NMB L7	C115331-9142	DEM 9P NMBL7-FR022	C115371-0126	
340100101B	DEM 9S NMB L7	C115331-9143	DEM 9S NMBL7-FR022	C115371-0127	
340100101B	DAM 15P NMB L7	C115371-9146	DAM 15P NMBL7-FR022	C115371-0130	
340100101B	DAM 15S NMB L7	C115371-9147	DAM 15S NMBL7-FR022	C115371-0131	
340100101B	DBM 25P NMB L7	C115371-9156	DBM 25P NMBL7-FR022	C115371-0140	
340100101B	DBM 25S NMB L7	C115371-9157	DBM 25S NMBL7-FR022	C115371-0141	
340100101B	DCM 37P NMB L7	C115371-9168	DCM 37P NMBL7-FR022	C115371-0152	
340100101B	DCM 37S NMB L7	C115371-9169	DCM 37S NMBL7-FR022	C115371-0153	
340100101B	DDM 50P NMB L7	C115371-9182	DDM 50P NMBL7-FR022	C115371-0166	
340100101B	DDM 50S NMB L7	C115371-9183	DDM 50S NMBL7-FR022	C115371-0167	

L9

Description ESA/ESCC		Part Number	Description FR022		Part Number
340100101B	DEM 9P NMB L9	C115331-9192	DEM 9P NMBL9-FR022	C115371-0176	
340100101B	DEM 9S NMB L9	C115331-9193	DEM 9S NMBL9-FR022	C115371-0177	
340100101B	DAM 15P NMB L9	C115371-9196	DAM 15P NMBL9-FR022	C115371-0180	
340100101B	DAM 15S NMB L9	C115371-9197	DAM 15S NMBL9-FR022	C115371-0181	
340100101B	DBM 25P NMB L9	C115371-9206	DBM 25P NMBL9-FR022	C115371-0190	
340100101B	DBM 25S NMB L9	C115371-9207	DBM 25S NMBL9-FR022	C115371-0191	
340100101B	DCM 37P NMB L9	C115371-9218	DCM 37P NMBL9-FR022	C115371-0202	
340100101B	DCM 37S NMB L9	C115371-9219	DCM 37S NMBL9-FR022	C115371-0203	
340100101B	DDM 50P NMB L9	C115371-9232	DDM 50P NMBL9-FR022	C115371-0216	
340100101B	DDM 50S NMB L9	C115371-9233	DDM 50S NMBL9-FR022	C115371-0217	

3401-001 D*M Standard Density

Wire-Wrap Terminations type F179A.

Specific Dimensions

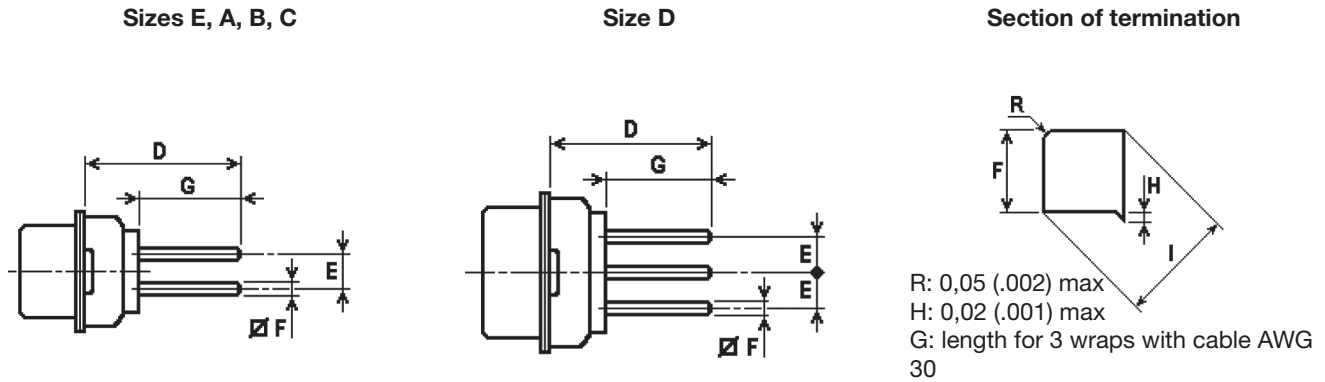

Contacts	Shell Size	D max	G ± 0,10 (.004)	E Typical	F ± 0,01 (.0004)	I ± 0,038 (.0015)	Pitch between contacts
Male	E	20,10 (.791)	12,70 (.500)	2,84 (.112)	0,60 (.024)	0,826 (.0325)	2,74 (.108)
	A	20,10 (.791)	12,70 (.500)	2,84 (.112)	0,60 (.024)	0,826 (.0325)	2,74 (.108)
	B	20,30 (.799)	12,70 (.500)	2,84 (.112)	0,60 (.024)	0,826 (.0325)	2,76 (.109)
	C	20,30 (.799)	12,70 (.500)	2,84 (.112)	0,60 (.024)	0,826 (.0325)	2,76 (.109)
	D	20,30 (.799)	12,70 (.500)	2,84 (.112)	0,60 (.024)	0,826 (.0325)	2,76 (.109)
Female	E	20,10 (.791)	12,70 (.500)	2,84 (.112)	0,60 (.024)	0,826 (.0325)	2,74 (.108)
	A	20,10 (.791)	12,70 (.500)	2,84 (.112)	0,60 (.024)	0,826 (.0325)	2,74 (.108)
	B	20,10 (.791)	12,70 (.500)	2,84 (.112)	0,60 (.024)	0,826 (.0325)	2,76 (.109)
	C	20,10 (.791)	12,70 (.500)	2,84 (.112)	0,60 (.024)	0,826 (.0325)	2,76 (.109)
	D	20,10 (.791)	12,70 (.500)	2,84 (.112)	0,60 (.024)	0,826 (.0325)	2,76 (.109)

Termination Modifier: F179A
For other termination modifier, consult factory

Weights

	Shell Size	Male Contact	Female Contact
Max Weight (grams) per contact		0,28	0,34
Max Weight (grams) of all contacts per size	E	2,52	3,06
	A	4,20	5,10
	B	7,00	8,50
	C	10,36	12,58
	D	14,00	17,00

3401-001 D*M Standard Density

Cross references

Solder bucket

Standard

Description ESA/ESCC	Part Number
340100101B DEM 9P NMB F179A	C115371-5450
340100101B DEM 9S NMB F179A	C115371-5451
340100101B DAM 15P NMB F179A	C115371-5454
340100101B DAM 15S NMB F179A	C115371-5455
340100101B DBM 25P NMB F179A	C115371-5460
340100101B DBM 25S NMB F179A	C115371-5461
340100101B DCM 37P NMB F179A	C115371-5470
340100101B DCM 37S NMB F179A	C115371-5471
340100101B DDM 50P NMB F179A	C115371-5482
340100101B DDM 50S NMB F179A	C115371-5483

Description FR022	Part Number
DEM 9P NMB F179A-FR022	C115371-3450
DEM 9S NMB F179A-FR022	C115371-3451
DAM 15P NMB F179A-FR022	C115371-3454
DAM 15S NMB F179A-FR022	C115371-3455
DBM 25P NMB F179A-FR022	C115371-3460
DBM 25S NMB F179A-FR022	C115371-3461
DCM 37P NMB F179A-FR022	C115371-3470
DCM 37S NMB F179A-FR022	C115371-3471
DDM 50P NMB F179A-FR022	C115371-3482
DDM 50S NMB F179A-FR022	C115371-3483

Option Y

Description ESA/ESCC	Part Number
340100101B DEMY 9P NMB F179A	C115371-5500
340100101B DEMY 9S NMB F179A	C115371-5501
340100101B DAMY 15P NMB F179A	C115371-5504
340100101B DAMY 15S NMB F179A	C115371-5505
340100101B DBMY 25P NMB F179A	C115371-5510
340100101B DBMY 25S NMB F179A	C115371-5511
340100101B DCMY 37P NMB F179A	C115371-5520
340100101B DCMY 37S NMB F179A	C115371-5521
340100101B DDMY 50P NMB F179A	C115371-5532
340100101B DDMY 50S NMB F179A	C115371-5533

Description FR022	Part Number
DEMY 9P NMB F179A-FR022	C115371-3500
DEMY 9S NMB F179A-FR022	C115371-3501
DAMY 15P NMB F179A-FR022	C115371-3504
DAMY 15S NMB F179A-FR022	C115371-3505
DBMY 25P NMB F179A-FR022	C115371-3510
DBMY 25S NMB F179A-FR022	C115371-3511
DCMY 37P NMB F179A-FR022	C115371-3520
DCMY 37S NMB F179A-FR022	C115371-3521
DDMY 50P NMB F179A-FR022	C115371-3532
DDMY 50S NMB F179A-FR022	C115371-3533

Option E

Description ESA/ESCC	Part Number
340100101B DEME 9P NMB F179A	C115371-5550
340100101B DEME 9S NMB F179A	C115371-5551
340100101B DAME 15P NMB F179A	C115371-5554
340100101B DAME 15S NMB F179A	C115371-5555
340100101B DBME 25P NMB F179A	C115371-5560
340100101B DBME 25S NMB F179A	C115371-5561
340100101B DCME 37P NMB F179A	C115371-5570
340100101B DCME 37S NMB F179A	C115371-5571
340100101B DDME 50P NMB F179A	C115371-5582
340100101B DDME 50S NMB F179A	C115371-5583

Description FR022	Part Number
DEME 9P NMB F179A-FR022	C115371-3550
DEME 9S NMB F179A-FR022	C115371-3551
DAME 15P NMB F179A-FR022	C115371-3554
DAME 15S NMB F179A-FR022	C115371-3555
DBME 25P NMB F179A-FR022	C115371-3560
DBME 25S NMB F179A-FR022	C115371-3561
DCME 37P NMB F179A-FR022	C115371-3570
DCME 37S NMB F179A-FR022	C115371-3571
DDME 50P NMB F179A-FR022	C115371-3582
DDME 50S NMB F179A-FR022	C115371-3583

3401-001 D*M Standard Density

Combination Arrangements

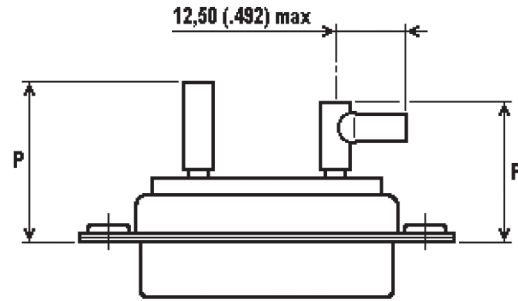
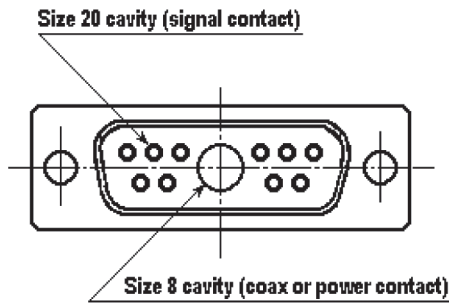

P max (Coaxial Contacts)

Contacts	Shell Size	Note 1	Note 2	Note 3	Note 4
Male	E	19,60 (.772)	22,30 (.878)	14,30 (.563)	14,40 (.567)
	A	19,60 (.772)	22,30 (.878)	14,30 (.563)	14,40 (.567)
	B	19,80 (.780)	22,50 (.886)	14,50 (.571)	14,60 (.575)
	C	19,80 (.780)	22,50 (.886)	14,50 (.571)	14,60 (.575)
	D	19,80 (.780)	22,50 (.886)	14,50 (.571)	14,60 (.575)
Female	E	19,60 (.772)	22,30 (.878)	14,30 (.563)	14,40 (.567)
	A	19,60 (.772)	22,30 (.878)	14,30 (.563)	14,40 (.567)
	B	19,60 (.772)	22,30 (.878)	14,30 (.563)	14,40 (.567)
	C	19,60 (.772)	22,30 (.878)	14,30 (.563)	14,40 (.567)
	D	19,60 (.772)	22,30 (.878)	14,30 (.563)	14,40 (.567)

P max (Power Contacts)

Note 5	Note 6	Note 7	Note 8
17,70 (.697)	19,80 (.780)	16,90 (.665)	14,60 (.575)
17,70 (.697)	19,80 (.780)	16,90 (.665)	14,60 (.575)
17,90 (.705)	20,00 (.787)	17,10 (.673)	14,80 (.583)
17,90 (.705)	20,00 (.787)	17,10 (.673)	14,80 (.583)
17,90 (.705)	20,00 (.787)	17,10 (.673)	14,80 (.583)
17,70 (.697)	19,80 (.780)	16,90 (.665)	14,60 (.575)
17,70 (.697)	19,80 (.780)	16,90 (.665)	14,60 (.575)
17,70 (.697)	19,80 (.780)	16,90 (.665)	14,60 (.575)
17,70 (.697)	19,80 (.780)	16,90 (.665)	14,60 (.575)
17,70 (.697)	19,80 (.780)	16,90 (.665)	14,60 (.575)

Note 1: ESA/ESCC 3401/004 variants 01 / 02 / 05 / 06 / 11 / 12 / 15 / 16

Note 2: ESA/ESCC 3401/004 variants 09 / 10 / 19 / 20

Note 3: ESA/ESCC 3401/004 variants 03 / 04 / 07 / 08

Note 4: ESA/ESCC 3401/004 variants 13 / 14 / 17 / 18

Note 5: ESA/ESCC 3401/040 variants 01 / 02 / 03 / 04 / 05 / 06

Note 6: ESA/ESCC 3401/040 variants 07 / 08

Note 7: ESA/ESCC 3401/040 variants 09 / 10

Note 8: ESA/ESCC 3401/040 variants 11 / 12

Combination Arrangements

Shell Size						
E	5W1					
A	3W3	3WK3	7W2	11W1		
B	5W5	9W4	13W3	17W2	21W1	
C	8W8	13W6	17W5	21WA4	25W3	27W2
D	24W7	36W4	43W2	47W1		

3401-001 D*M Standard Density

PCB Hole Pattern

Face view, pin insert

Size E

9 contacts

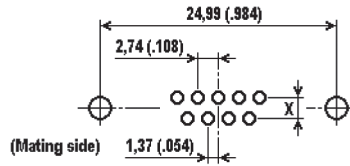

Size A

15 contacts

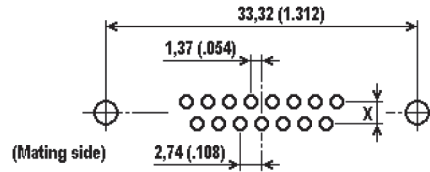

Size B

25 contacts

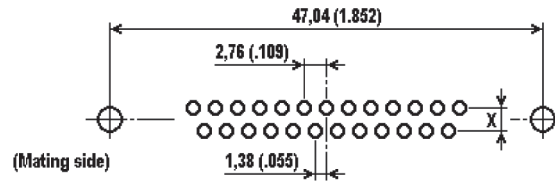

Size C

37 contacts

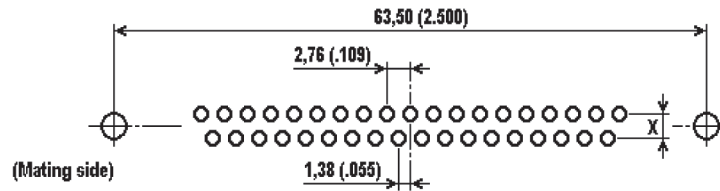

Size D

50 contacts

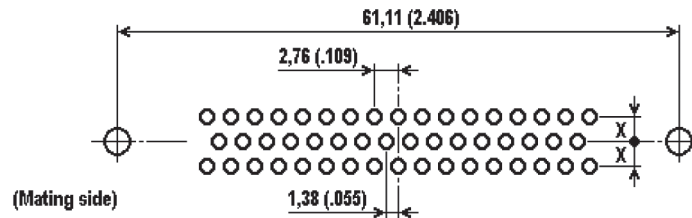

Dimension X

- 2,54 (.100) for "90° bent PCB / European Footprint Type 1AxN and 2AxN"
- 2,84 (.112) for "Straight PCB", "90° bent PCB / European Footprint Type 1BxN and 2BxN", and "90° bent PCB / U.S. Footprint"

Recommended PCB hole for signal contacts

- \varnothing 1,00 (.040) min for terminations \varnothing 0,60 (.024)
- \varnothing 1,15 (.045) min for terminations \varnothing 0,76 (.030)



*Dimensions are shown in mm (inch)
Dimensions subject to change*



*Dimensions are shown in mm (inch)
Dimensions subject to change*



*Dimensions are shown in mm (inch)
Dimensions subject to change*

Mouser Electronics

Authorized Distributor

Click to View Pricing, Inventory, Delivery & Lifecycle Information:

[C&K Aerospace:](#)

[340100101BDAM15SNMBZ](#)