



**SERIES:** PSK-S10C | **DESCRIPTION:** AC-DC POWER SUPPLY

**FEATURES**

- universal input (85~264 Vac)
- -40~70°C operating range
- over voltage/current protection
- 4,000 Vac input/output isolation voltage
- board/chassis/DIN-Rail configurations
- CISPR32/EN55032 Class B
- UL/EN/IEC 62368-1 and EN 60335-1 certified



| MODEL       | output voltage<br>(Vdc) | output current |             | output power<br>max<br>(W) | ripple and noise <sup>1</sup><br>max<br>(mVp-p) | efficiency <sup>2</sup><br>typ<br>(%) |
|-------------|-------------------------|----------------|-------------|----------------------------|---|---------------------------------------|
|             |                         | min<br>(mA)    | max<br>(mA) |                            |   |                                       |
| PSK-S10C-3  | 3.3                     | 0              | 2000        | 6.6                        | 100   | 71                                    |
| PSK-S10C-5  | 5                       | 0              | 2000        | 10                         | 100   | 76                                    |
| PSK-S10C-9  | 9                       | 0              | 1100        | 10                         | 100   | 80                                    |
| PSK-S10C-12 | 12                      | 0              | 900         | 10                         | 100   | 81                                    |
| PSK-S10C-15 | 15                      | 0              | 700         | 10                         | 100   | 81                                    |
| PSK-S10C-24 | 24                      | 0              | 450         | 10                         | 100   | 83                                    |

Notes: 1. At full load, nominal input, 20 MHz bandwidth oscilloscope, with 1 μF ceramic and 10 μF electrolytic capacitors on the output.  
 2. At 230 Vac input.  
 3. All specifications are measured at Ta=25°C, humidity <75%, nominal input voltage, and rated output load unless otherwise specified.

**PART NUMBER KEY**

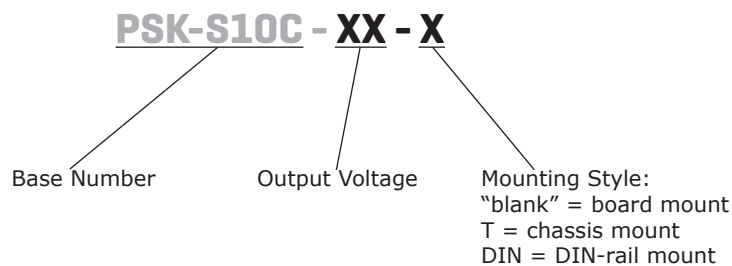

## INPUT

| parameter                 | conditions/description | min | typ | max | units |
|---------------------------|------------------------|-----|-----|-----|-------|
| voltage                   |                        | 85  |     | 264 | Vac   |
|                           |                        | 100 |     | 370 | Vdc   |
| frequency                 |                        | 47  |     | 63  | Hz    |
| current                   | at 115 Vac             |     |     | 230 | mA    |
|                           | at 230 Vac             |     |     | 150 | mA    |
| inrush current            | at 115 Vac             |     | 15  |     | A     |
|                           | at 230 Vac             |     | 30  |     | A     |
| no load power consumption |                        |     |     | 0.5 | W     |

## OUTPUT

| parameter                  | conditions/description | min | typ   | max    | units |
|----------------------------|------------------------|-----|-------|--------|-------|
| capacitive load            | 3.3 Vdc output models  |     |       | 26,400 | μF    |
|                            | 5 Vdc output models    |     |       | 9,440  | μF    |
|                            | 9 Vdc output models    |     |       | 3,600  | μF    |
|                            | 12 Vdc output models   |     |       | 2,000  | μF    |
|                            | 15 Vdc output models   |     |       | 1,170  | μF    |
|                            | 24 Vdc output models   |     |       | 370    | μF    |
| initial set point accuracy | 3.3 Vdc output models  |     | ±3    |        | %     |
|                            | all other models       |     | ±2    |        | %     |
| line regulation            | at full load           |     | ±0.5  |        | %     |
| load regulation            | from 0~100% load       |     | ±1    |        | %     |
| hold-up time               | at 115 Vac, full load  |     | 15    |        | ms    |
|                            | at 230 Vac, full load  |     | 80    |        | ms    |
| switching frequency        |                        |     | 100   |        | kHz   |
| temperature coefficient    |                        |     | ±0.02 |        | %/°C  |

## PROTECTIONS

| parameter                | conditions/description            | min | typ | max | units |
|--------------------------|-----------------------------------|-----|-----|-----|-------|
| over voltage protection  | output voltage clamp              |     |     |     |       |
|                          | 3.3, 5 Vdc output models          |     |     | 7.5 | Vdc   |
|                          | 9 Vdc output models               |     |     | 15  | Vdc   |
|                          | 12, 15 Vdc output models          |     |     | 20  | Vdc   |
|                          | 24 Vdc output models              |     |     | 30  | Vdc   |
| over current protection  | auto recovery                     | 110 |     | 300 | %     |
| short circuit protection | hiccup, continuous, auto recovery |     |     |     |       |

## SAFETY & COMPLIANCE

| parameter           | conditions/description                             | min   | typ | max | units |
|---------------------|--|-------|-----|-----|-------|
| isolation voltage   | input to output for 1 minute, 5 mA                 | 4,000 |     |     | Vac   |
| safety approvals    | UL 62368-1, EN 62368-1, IEC 62368-1, EN 60335-1    |       |     |     |       |
| safety class        | Class II   |       |     |     |       |
| conducted emissions | CISPR32/EN55032, Class B                           |       |     |     |       |
| radiated emissions  | CISPR32/EN55032, Class B                           |       |     |     |       |
| ESD                 | IEC/EN61000-4-2, contact ±6 kV/ air ±8 kV, Class B |       |     |     |       |
| radiated immunity   | IEC/EN61000-4-3, 10 V/m, Class A                   |       |     |     |       |

## SAFETY & COMPLIANCE (CONTINUED)

| parameter                    | conditions/description  | min     | typ | max | units |
|------------------------------|---|---------|-----|-----|-------|
| EFT/burst                    | IEC/EN61000-4-4, ±2 kV, Class B   |         |     |     |       |
|                              | IEC/EN61000-4-4, ±4 kV, Class B (external circuit required, see Figure 2)                                   |         |     |     |       |
| surge                        | IEC/EN61000-4-5, line to line ±1 kV, Class B (external circuit required, see Figure 1)                      |         |     |     |       |
|                              | IEC/EN61000-4-5, line to line ±2 kV/line to ground ±4 kV, Class B (external circuit required, see Figure 2) |         |     |     |       |
| conducted immunity           | IEC/EN61000-4-6, 10 Vrms, Class A   |         |     |     |       |
| voltage dips & interruptions | IEC/EN61000-4-11 Class B, 0%-70%  |         |     |     |       |
| MTBF                         | as per MIL-HDBK-217F at 25°C  | 300,000 |     |     | hours |
| RoHS                         | yes   |         |     |     |       |

Notes: 4. The power supply is considered a component which will be installed into final equipment. The final equipment still must be tested to meet the necessary EMC directives.

## ENVIRONMENTAL

| parameter             | conditions/description | min | typ | max | units |
|-----------------------|------------------------|-----|-----|-----|-------|
| operating temperature | see derating curves    | -40 |     | 70  | °C    |
| storage temperature   |                        | -40 |     | 105 | °C    |
| storage humidity      | non-condensing         |     |     | 95  | %     |

## SOLDERABILITY<sup>5</sup>

| parameter      | conditions/description | min | typ | max | units |
|----------------|------------------------|-----|-----|-----|-------|
| hand soldering | for 3~5 seconds        | 350 | 360 | 370 | °C    |
| wave soldering | for 5~10 seconds       | 255 | 260 | 265 | °C    |

Notes: 5. For board mount models only

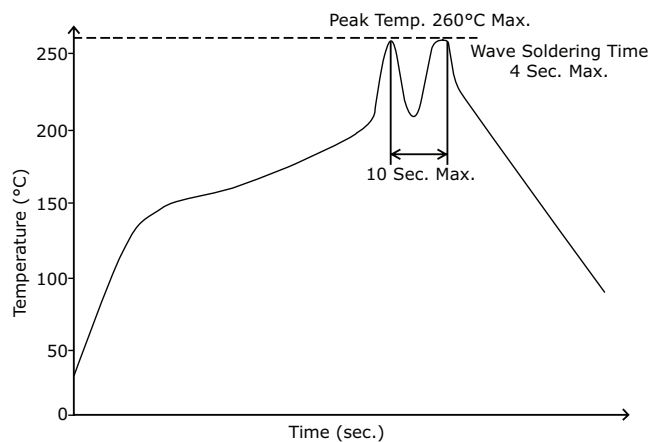

## DERATING CURVES

Load vs. Ambient Temperature  
(at 85~264 Vac / 100~370 Vdc Input Voltage)

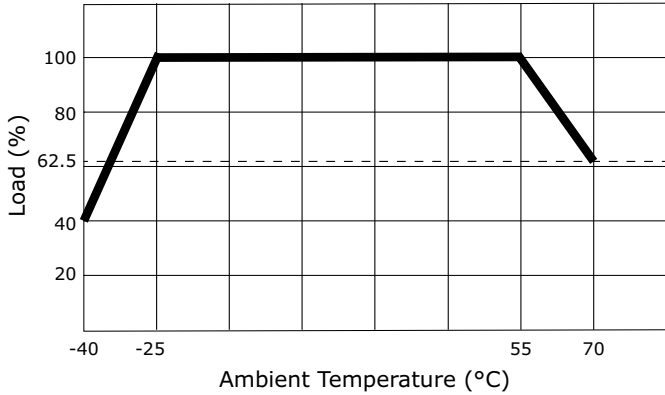

Load vs. Input Voltage  
(at 25°C Ambient Temperature)

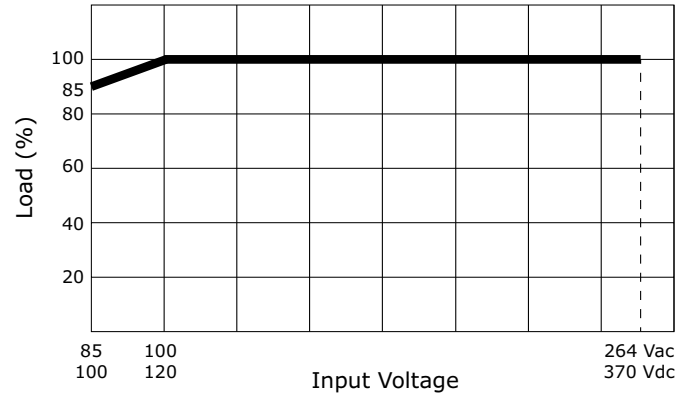

## EFFICIENCY CURVES

Efficiency vs. Input Voltage  
(at full load)

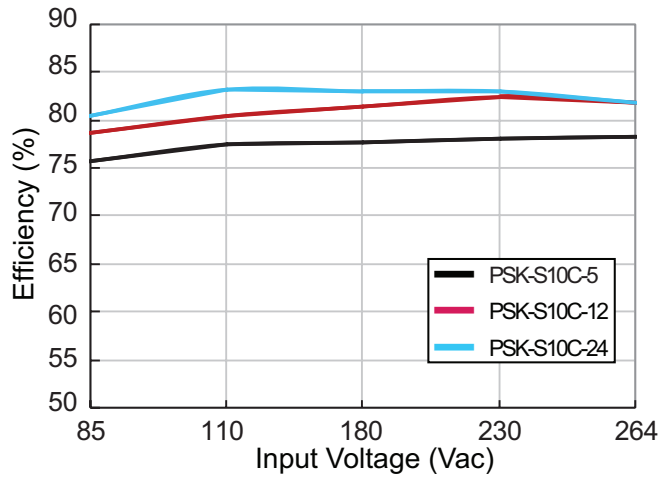

Efficiency vs. Load Current  
(at 230 Vac)

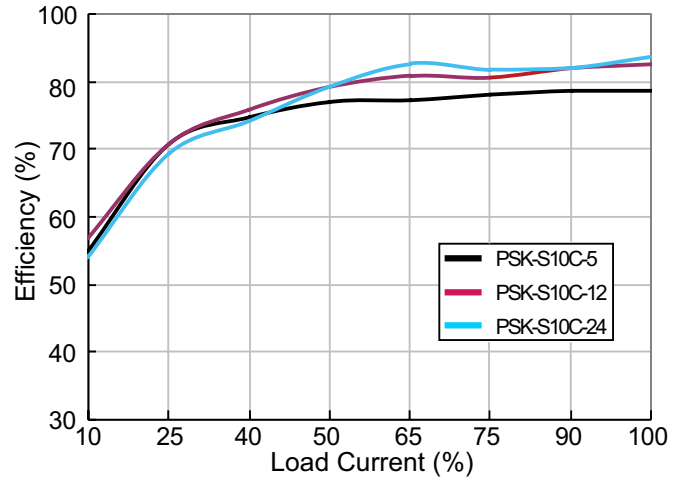

## MECHANICAL

| parameter     | conditions/description  | min | typ | max | units |
|---------------|---|-----|-----|-----|-------|
| dimensions    | board mount: 53.80 x 28.80 x 19.00 (2.118 x 1.134 x 0.748 inch)   |     |     |     | mm    |
|               | chassis mount: 76.00 x 31.50 x 27.80 (2.992 x 1.24 x 1.094 inch)  |     |     |     | mm    |
|               | DIN-Rail mount: 76.00 x 31.50 x 32.40 (2.992 x 1.24 x 1.276 inch) |     |     |     | mm    |
| case material | black flame-retardant and heat-resistant plastic (UL94V-0)        |     |     |     |       |
| weight        | board mount   |     | 48  |     | g     |
|               | chassis mount   |     | 68  |     | g     |
|               | DIN-Rail mount  |     | 88  |     | g     |

## MECHANICAL DRAWING (BOARD MOUNT)

units: mm[inch]  
 tolerance: ±0.50[±0.020]  
 pin diameter tolerance: ±0.10[±0.004]

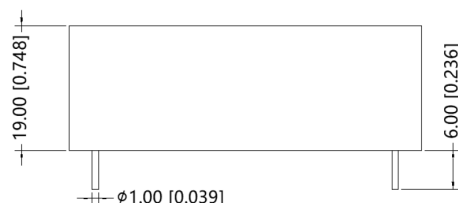

| PIN CONNECTIONS |          |
|-----------------|----------|
| PIN             | Function |
| 1               | AC (N)   |
| 2               | AC (L)   |
| 3               | -Vo      |
| 4               | +Vo      |

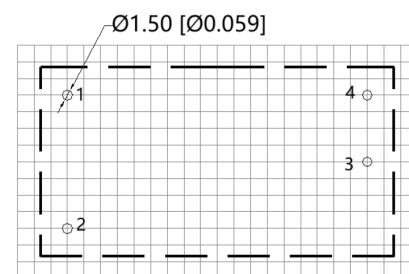
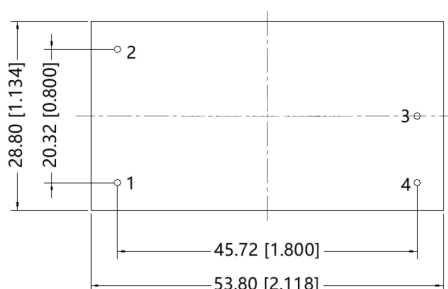

Note : Grid 2.54\*2.54mm  
 Recommended PCB Layout  
 Top View

## MECHANICAL DRAWING (CHASSIS MOUNT)

units: mm[inch]  
 tolerance: ±0.50[±0.020]  
 wire range: 24~12 AWG  
 tightening torque: max 0.4 N\*m

| PIN CONNECTIONS |          |
|-----------------|----------|
| PIN             | Function |
| 1               | AC (N)   |
| 2               | AC (L)   |
| 3               | -Vo      |
| 4               | +Vo      |

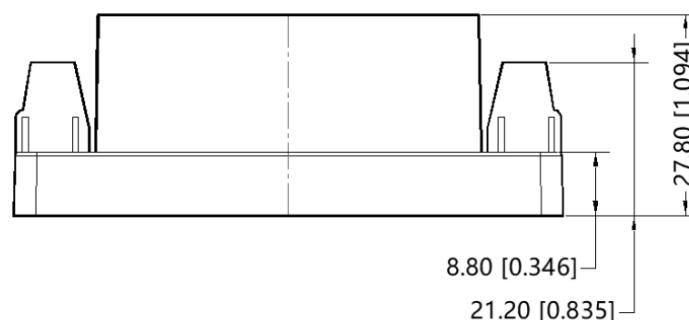
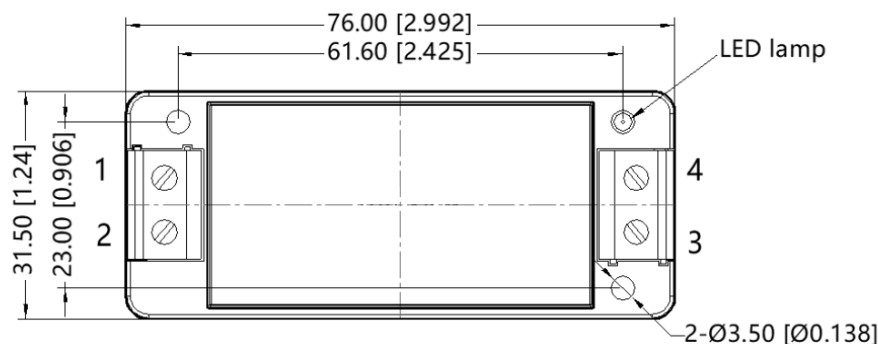

## MECHANICAL DRAWING (DIN-RAIL MOUNT)

units: mm [inch]  
tolerance:  $\pm 0.050$  [ $\pm 0.020$ ]

installed on DIN Rail TS35  
wire range: 24~12 AWG  
tightening torque: max 0.4 N\*m

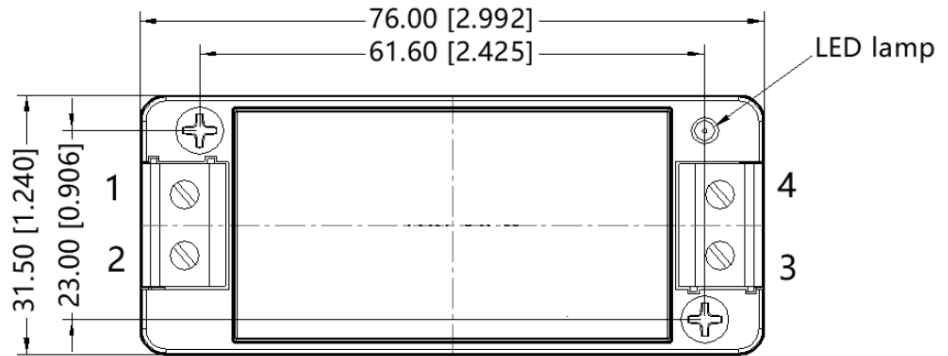

| PIN CONNECTIONS |          |
|-----------------|----------|
| PIN             | Function |
| 1               | AC (N)   |
| 2               | AC (L)   |
| 3               | -Vo      |
| 4               | +Vo      |

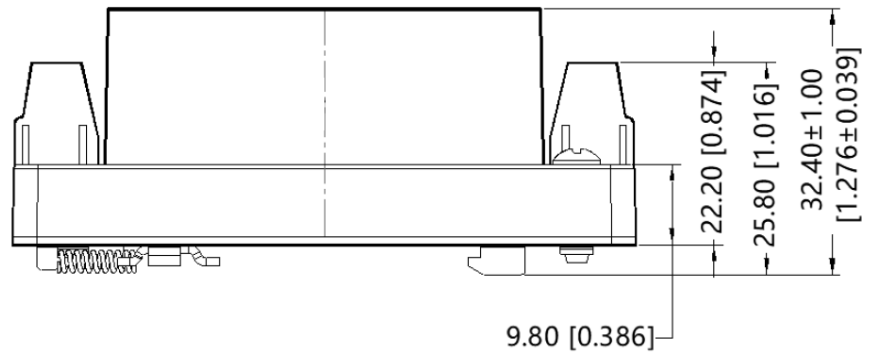

## APPLICATION CIRCUIT

Figure 1

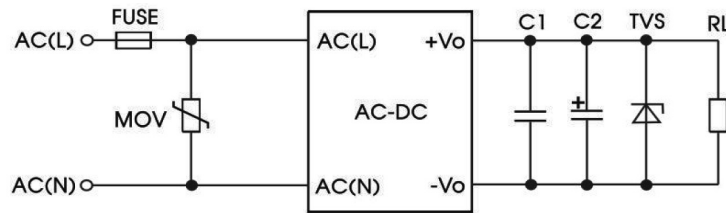

Table 1

| Recommended External Circuit Components |         |         |                |                 |          |
|---|---------|---------|----------------|-----------------|----------|
| Vo (Vdc)                                | FUSE    | MOV     | C1             | C2              | TVS      |
| 3.3                                     | 2A/250V | S14K300 | 1 $\mu$ F/50 V | 220 $\mu$ F/10V | SMBJ7.0A |
| 5                                       | 2A/250V | S14K300 | 1 $\mu$ F/50 V | 220 $\mu$ F/10V | SMBJ7.0A |
| 9                                       | 2A/250V | S14K300 | 1 $\mu$ F/50 V | 120 $\mu$ F/25V | SMBJ12A  |
| 12                                      | 2A/250V | S14K300 | 1 $\mu$ F/50 V | 120 $\mu$ F/25V | SMBJ20A  |
| 15                                      | 2A/250V | S14K300 | 1 $\mu$ F/50 V | 120 $\mu$ F/25V | SMBJ20A  |
| 24                                      | 2A/250V | S14K300 | 1 $\mu$ F/50 V | 68 $\mu$ F/35V  | SMBJ30A  |

## EMC RECOMMENDED CIRCUIT

Figure 2

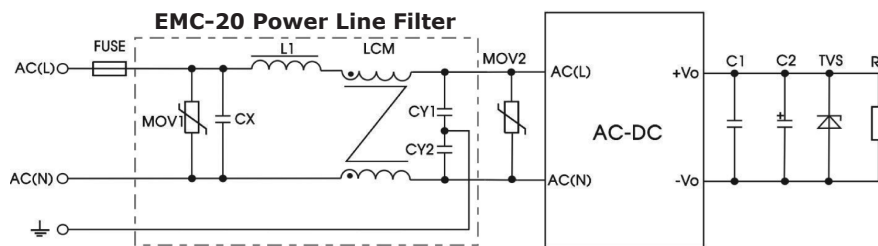

Table 2

| Recommended External Circuit Components |                           |
|---|---------------------------|
| FUSE                                    | 3.15 A/250 V, slow fusing |
| MOV1                                    | S14K350                   |
| LCM                                     | 10 mH                     |
| CX                                      | 0.1 $\mu$ F/275 Vac       |
| CY1, CY2                                | 1000 pF/400 Vac           |
| L1                                      | 47 $\mu$ H/2 A            |
| MOV2                                    | S14K300                   |

Note: Also refer to Table 1.

- Notes:
- C1 is a ceramic capacitor used to filter high frequency noise.
  - C2 is an electrolytic capacitor and it is recommended to be high frequency and low impedance. For capacitance and current of capacitor, refer to the datasheet provided by the manufacturer. Voltage derating of capacitor should be at least 80%.
  - TVS is a recommended component to protect post-circuits (if converter fails).

## REVISION HISTORY

---

| rev. | description     | date       |
|------|-----------------|------------|
| 1.0  | initial release | 03/07/2019 |

The revision history provided is for informational purposes only and is believed to be accurate.



**Headquarters**  
20050 SW 112th Ave.  
Tualatin, OR 97062  
**800.275.4899**

Fax 503.612.2383  
**cui.com**  
techsupport@cui.com

CUI offers a two (2) year limited warranty. Complete warranty information is listed on our website.

CUI reserves the right to make changes to the product at any time without notice. Information provided by CUI is believed to be accurate and reliable. However, no responsibility is assumed by CUI for its use, nor for any infringements of patents or other rights of third parties which may result from its use.

CUI products are not authorized or warranted for use as critical components in equipment that requires an extremely high level of reliability. A critical component is any component of a life support device or system whose failure to perform can be reasonably expected to cause the failure of the life support device or system, or to affect its safety or effectiveness.



# Mouser Electronics

Authorized Distributor

Click to View Pricing, Inventory, Delivery & Lifecycle Information:

[CUI Inc.:](#)

[PSK-S10C-24](#) [PSK-S10C-9](#) [PSK-S10C-15](#) [PSK-S10C-5](#) [PSK-S10C-3](#) [PSK-S10C-12](#)