

REVISIONS			
REV	ECN, ERN NO.	DATE	APPRD.
D	PRODUCT DRAWING (EAR 14658)	MAY07/18	K.L.

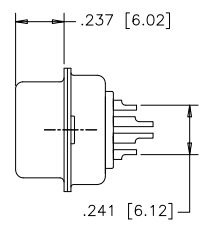
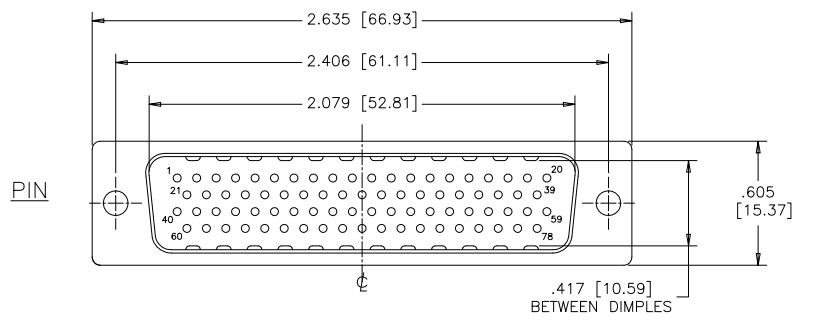

ORDERING CODE:

PART NUMBER: 17EHD-078PAM-100

SERIES _____
 NUMBER OF CONTACTS _____
 STYLE _____
 P=PIN
 S=SOCKET

TERMINATION-MOUNTING OPTIONS
 000= SOLDER CUP, .120 [3.05] DIA. THROUGH HOLE
 100= SOLDER CUP, #4-40 UNC THREADED HOLES
 200= SOLDER CUP, #4-40 UNC HEX JACK SOCKETS INSTALLED

CONTACT PLATING OPTIONS FOR ENGAGEMENT AREA
 AA= GOLD FLASH
 CH= 15µ" [0.38 MICRONS] GOLD
 AM= 30µ" [0.76 MICRONS] GOLD

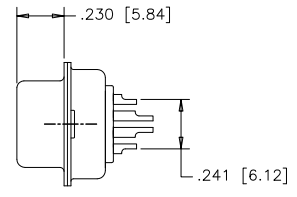
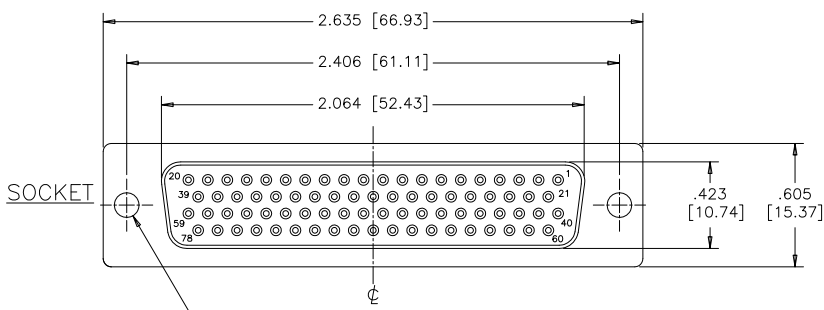

SPECIFICATIONS:

MATERIALS: ALL MATERIALS ARE RoHS COMPLIANT
SHELL: STEEL, NICKEL PLATED
INSERTS: ENGINEERING THERMOPLASTIC PBT, GLASS REINFORCED, UL FLAMMABILITY RATING 94V-0, COLOUR: BLACK
CONTACTS: COPPER ALLOY, GOLD PLATING (SEE ORDERING CODE) OVER 50µ" [1.27 MICRONS] NICKEL ON ENGAGEMENT AREA WITH 100µ" [2.54 MICRONS] MIN. MATTE TIN ON CONTACT TERMINALS.

TERMINATION-MTG OPTION 000
 SOLDER CUP,
 .120 [3.05] DIA.
 THROUGH HOLE (2 PLACES)

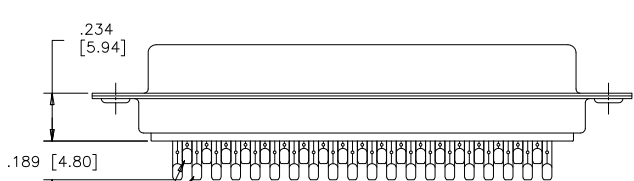

SOLDER CUP WITH
 .028 [0.71] INSIDE
 DIAMETER WIRE HOLE

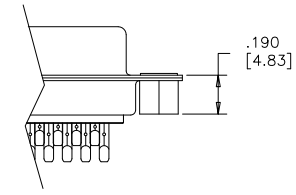

TERMINATION-MTG OPTION 100
 SOLDER CUP, #4-40 UNC
 THREADED THROUGH HOLES

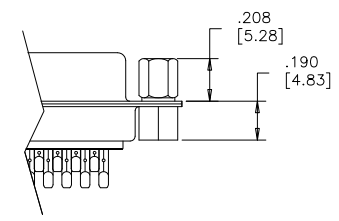

TERMINATION-MTG OPTION 200
 SOLDER CUP, #4-40 UNC HEX
 JACK SOCKETS INSTALLED

ELECTRICAL DATA:

CURRENT RATING: 3 AMP
 CONTACT RESISTANCE: 15 MILLIOHMS MAX.
 INSULATION RESISTANCE: 3000 MEGOHMS MIN.
 DIELECTRIC WITHSTANDING VOLTAGE: 1000 VAC rms
 OPERATING TEMPERATURE: -55°C TO +105°C

THIS DOCUMENT CONTAINS PROPRIETARY INFORMATION AND SUCH INFORMATION MAY NOT BE DISCLOSED TO OTHERS FOR ANY PURPOSE OR USED FOR MANUFACTURING PURPOSES WITHOUT WRITTEN PERMISSION FROM AMPHENOL CANADA CORP.



DRAWN	J.LEE	DATE	OCT03/06
DESIGNED			
CHECKED	K.LAMBIE	DATE	OCT03/06
I. E. APPRD.			
Q. A. APPRD.			
DWG. APPRD.			
ENG. REL. NO.		DWG	DRAWING NO.
REF.	EAR 12956	C	P-17EHD-078XXX-X00
DIMENSIONS ARE IN	CODE ID. NO.	SCALE	WT. SURF. SHEET
INCHES	03554	2/1	----- 1 OF 1

Amphenol Canada Corp.
 TITLE: 17EHD SERIES HIGH DENSITY D-SUB CONNECTOR, 78 SIZE, SOLDER CUP, PLATING & MOUNTING OPTIONS, RoHS COMPLIANT

DWG	DRAWING NO.	REV.
C	P-17EHD-078XXX-X00	D
SCALE	WT.	SURF.
2/1	-----	-----
SHEET 1 OF 1		

Mouser Electronics

Authorized Distributor

Click to View Pricing, Inventory, Delivery & Lifecycle Information:

[Amphenol:](#)

[17EHD078SAM000](#) [17EHD078PAA100](#) [17EHD078PAM100](#) [17EHD-078S-AA000](#) [17EHD-078P-AA000](#)