

FEATURES

- ±0.5°C (typical) threshold accuracy
- Pin-selectable trip points from
 - 45°C to +5°C in 10°C increments (undertemperature)
 - 45°C to 115°C in 10°C increments (overtemperature)
- Maximum operating temperature of 125°C
- Open-drain output (ADT6401)
- Push-pull output (ADT6402)
- Pin-selectable hysteresis of 2°C and 10°C
- Supply current of 30 µA (typical)
- Space-saving, 6-lead SOT-23 package

APPLICATIONS

- Medical equipment
- Automotive
- Cell phones
- Hard disk drives
- Personal computers
- Electronic test equipment
- Domestic appliances
- Process control

GENERAL DESCRIPTION

The ADT6401/ADT6402 are trip point temperature switches available in a 6-lead SOT-23 package. Each part contains an internal band gap temperature sensor for local temperature sensing. When the temperature crosses the trip point setting, the logic output is activated. The ADT6401 logic output is active low and open-drain. The ADT6402 logic output is active high and push-pull. The temperature is digitized to a resolution of 0.125°C (11-bit). The pin-selectable trip point settings are 10°C apart starting from –45°C to +5°C for undertemperature switching, and from 45°C to 115°C for overtemperature switching.

These devices typically consume 30 µA of supply current. Hysteresis is pin selectable at 2°C and 10°C. The temperature switch is specified to operate over the supply range of 2.7 V to 5.5 V.

When the ADT6401/ADT6402 are used for monitoring temperatures from 45°C to 115°C, the logic output pin becomes active when the temperature goes higher than the selected trip point temperature.

FUNCTIONAL BLOCK DIAGRAM

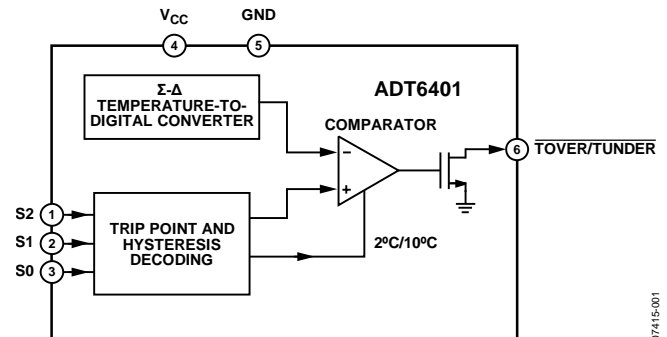

Figure 1.

07415-001

When the ADT6401/ADT6402 are used for monitoring temperatures from –45°C to +5°C, the logic output pin becomes active when the temperature goes lower than the selected trip point temperature.

PRODUCT HIGHLIGHTS

1. Σ-Δ based temperature measurement gives high accuracy and noise immunity.
2. Wide operating temperature range from –55°C to +125°C.
3. ±0.5°C typical accuracy from –45°C to +115°C.
4. Pin-selectable threshold settings from –45°C to +115°C in 10°C increments.
5. Supply voltage is 2.7 V to 5.5 V.
6. Supply current of 30 µA.
7. Space-saving, 6-lead SOT-23 package.
8. Pin-selectable temperature hysteresis of 2°C or 10°C.
9. Temperature resolution of 0.125°C.

TABLE OF CONTENTS

Features	1	Theory of Operation	9
Applications.....	1	Circuit Information.....	9
Functional Block Diagram	1	Converter Details	9
General Description	1	Pin-Selectable Trip Point and Hysteresis	9
Product Highlights	1	Temperature Conversion.....	10
Revision History	2	Applications Information	11
Specifications.....	3	Thermal Response Time	11
Absolute Maximum Ratings.....	4	Self-Heating Effects.....	11
ESD Caution.....	4	Supply Decoupling	11
Pin Configurations and Function Descriptions	5	Temperature Monitoring.....	11
Typical Performance Characteristics	6	Outline Dimensions	12
Typical Application Circuits.....	8	Ordering Guide	12

REVISION HISTORY

4/13—Rev. B to Rev. C	
Change to Figure 16	8
9/12—Rev. A to Rev. B	
Change to Specifications Table 1, Supply Current Parameter	3
6/10—Rev. 0 to Rev. A	
Changes to Table 4.....	9
Updated Outline Dimensions	12
5/08—Revision 0: Initial Version	

SPECIFICATIONS

$T_A = -55^\circ\text{C}$ to $+125^\circ\text{C}$, $V_{CC} = 2.7\text{ V}$ to 5.5 V , open-drain $R_{PULL-UP} = 10\text{ k}\Omega$, unless otherwise noted.

Table 1.

Parameter	Min	Typ	Max	Unit	Test Conditions/Comments
TEMPERATURE SENSOR AND ADC					
Threshold Accuracy		± 0.5	± 6	$^\circ\text{C}$	$T_A = -45^\circ\text{C}$ to -25°C
		± 0.5	± 4	$^\circ\text{C}$	$T_A = -15^\circ\text{C}$ to $+15^\circ\text{C}$
		± 0.5	± 4	$^\circ\text{C}$	$T_A = 35^\circ\text{C}$ to 65°C
		± 0.5	± 6	$^\circ\text{C}$	$T_A = 75^\circ\text{C}$ to 115°C
ADC Resolution		11		Bits	
Temperature Conversion Time		30		ms	Time necessary to complete a conversion
Update Rate		600		ms	Conversion started every 600 ms
Temperature Threshold Hysteresis		2		$^\circ\text{C}$	Pin selectable, depends on S0, S1, S2 settings
		10		$^\circ\text{C}$	Pin selectable, depends on S0, S1, S2 settings
DIGITAL OUTPUT (OPEN-DRAIN)					
Output High Current, I_{OH}		10		nA	Leakage current, $V_{CC} = 2.7\text{ V}$ and $V_{OH} = 5.5\text{ V}$
Output Low Voltage, V_{OL}			0.3	V	$I_{OL} = 1.2\text{ mA}$, $V_{CC} = 2.7\text{ V}$
			0.4	V	$I_{OL} = 3.2\text{ mA}$, $V_{CC} = 4.5\text{ V}$
Output Capacitance, C_{OUT}^1			10	pF	$R_{PULL-UP} = 10\text{ k}\Omega$
DIGITAL OUTPUT (PUSH-PULL)					
Output Low Voltage, V_{OL}			0.3	V	$I_{OL} = 1.2\text{ mA}$, $V_{CC} = 2.7\text{ V}$
			0.4	V	$I_{OL} = 3.2\text{ mA}$, $V_{CC} = 4.5\text{ V}$
Output High Voltage, V_{OH}	$0.8 \times V_{CC}$			V	$I_{SOURCE} = 500\text{ }\mu\text{A}$, $V_{CC} = 2.7\text{ V}$
	$V_{CC} - 1.5$			V	$I_{SOURCE} = 800\text{ }\mu\text{A}$, $V_{CC} = 4.5\text{ V}$
Output Capacitance, C_{OUT}^1			10	pF	
POWER REQUIREMENTS					
Supply Voltage	2.7		5.5	V	
Supply Current		30	55	μA	

¹ Guaranteed by design and characterization.

ABSOLUTE MAXIMUM RATINGS

Table 2.

Parameter	Rating
V _{CC} to GND	-0.3 V to +7V
S0, S1, S2 Input Voltage to GND	-0.3 V to V _{CC} + 0.3 V
Open-Drain Output Voltage to GND	-0.3 V to +7V
Push-Pull Output Voltage to GND	-0.3 V to V _{CC} + 0.3 V
Input Current on All Pins	20 mA
Output Current on All Pins	20 mA
ESD rating (HBM)	1.5 kV
Operating Temperature Range	-55°C to +125°C
Storage Temperature Range	-65°C to +160°C
Maximum Junction Temperature, T _{JMAX}	150.7°C
6-Lead SOT-23 (RJ-6)	
Power Dissipation ¹	$W_{MAX} = (T_{JMAX} - T_A^2)/\theta_{JA}$
Thermal Impedance ³	
θ _{JA} , Junction-to-Ambient (Still Air)	229.6°C/W
IR Reflow Soldering (RoHS-Compliant Package)	
Peak Temperature	260°C (+0°C)
Time at Peak Temperature	20 sec to 40 sec
Ramp-Up Rate	3°C/sec maximum
Ramp-Down Rate	-6°C/sec maximum
Time 25°C to Peak Temperature	8 minute maximum

¹ Values relate to package being used on a standard 2-layer PCB, which gives a worst-case θ_{JA}. Refer to Figure 2 for a plot of maximum power dissipation vs. ambient temperature (T_A).

² T_A = ambient temperature.

³ Junction-to-case resistance is applicable to components featuring a preferential flow direction, for example, components mounted on a heat sink. Junction-to-ambient resistance is more useful for air-cooled, PCB-mounted components.

Stresses above those listed under Absolute Maximum Ratings may cause permanent damage to the device. This is a stress rating only; functional operation of the device at these or any other conditions above those indicated in the operational section of this specification is not implied. Exposure to absolute maximum rating conditions for extended periods may affect device reliability.

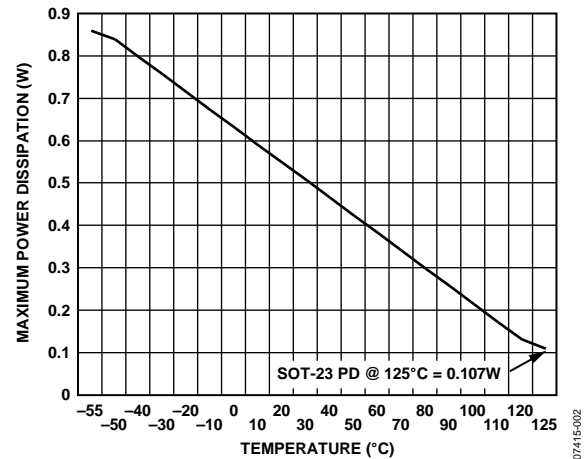

Figure 2. SOT-23 Maximum Power Dissipation vs. Temperature

ESD CAUTION



ESD (electrostatic discharge) sensitive device. Charged devices and circuit boards can discharge without detection. Although this product features patented or proprietary protection circuitry, damage may occur on devices subjected to high energy ESD. Therefore, proper ESD precautions should be taken to avoid performance degradation or loss of functionality.

PIN CONFIGURATIONS AND FUNCTION DESCRIPTIONS

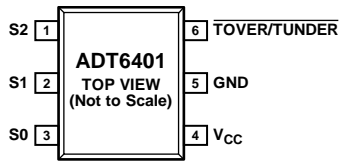

Figure 3. ADT6401 Pin Configuration

07415-003

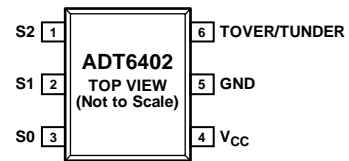

Figure 4. ADT6402 Pin Configuration

07415-004

Table 3. Pin Function Descriptions

Pin Number		Mnemonic	Description
ADT6401	ADT6402		
1	1	S2	Select Pin for Trip Point and Hysteresis Values.
2	2	S1	Select Pin for Trip Point and Hysteresis Values.
3	3	S0	Select Pin for Trip Point and Hysteresis Values.
4	4	V _{CC}	Supply Input (2.7 V to 5.5 V).
5	5	GND	Ground.
6	N/A	<u>TOVER/TUNDR</u>	Open-Drain, Active Low Output. Pull-up resistor required. This pin goes low when the temperature of the part exceeds the pin-selectable threshold.
N/A	6	TOVER/TUNDR	Push-Pull, Active High Output. This pin goes high when the temperature of the part exceeds the pin-selectable threshold.

TYPICAL PERFORMANCE CHARACTERISTICS

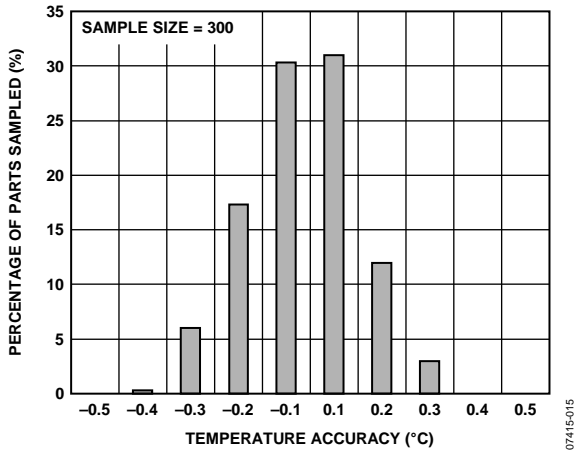

Figure 5. Trip Threshold Accuracy

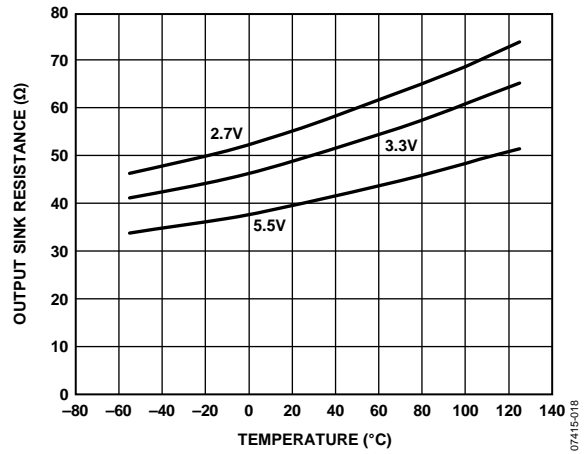

Figure 8. Output Sink Resistance vs. Temperature

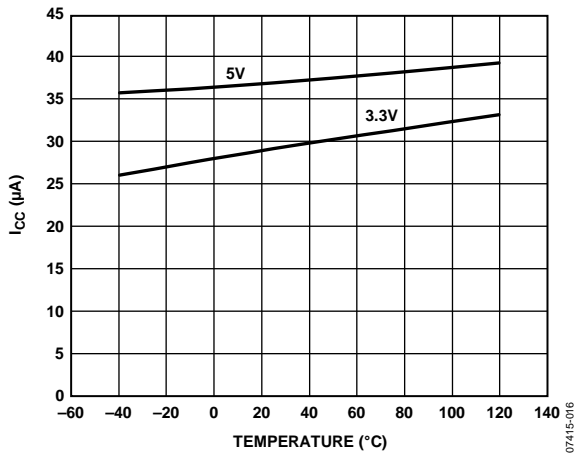

Figure 6. Operating Supply Current vs. Temperature

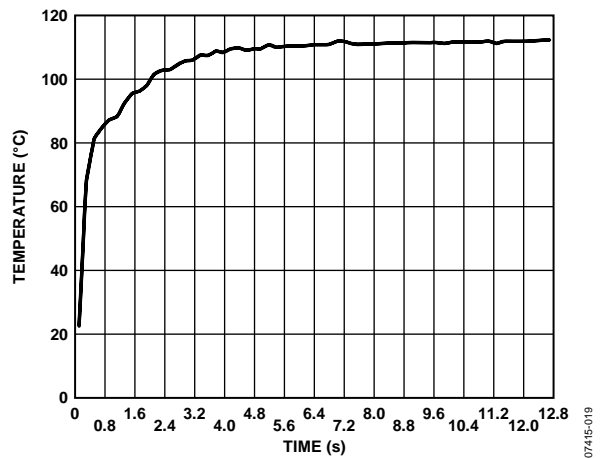

Figure 9. Thermal Step Response in Perfluorinated Fluid

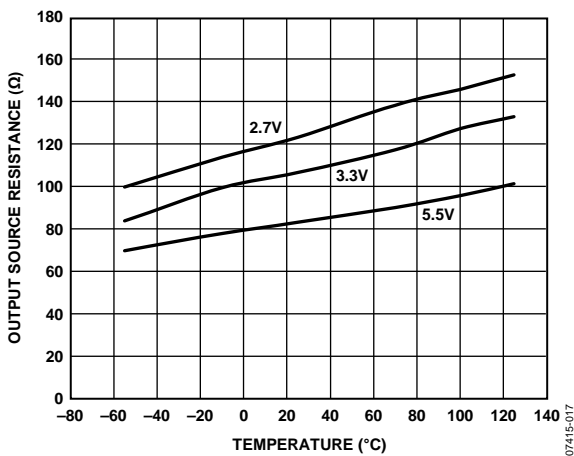

Figure 7. ADT6402 Output Source Resistance vs. Temperature

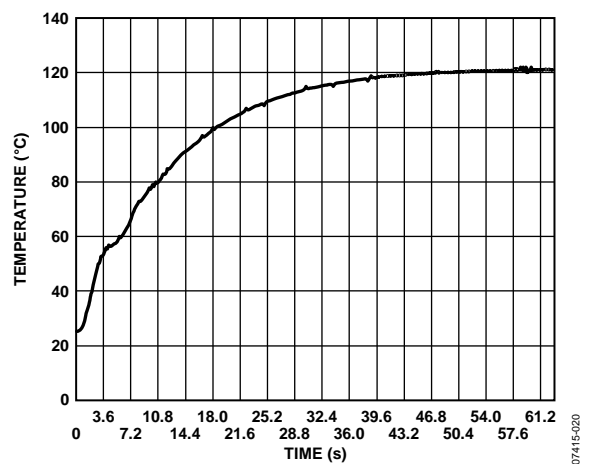

Figure 10. Thermal Step Response in Still Air

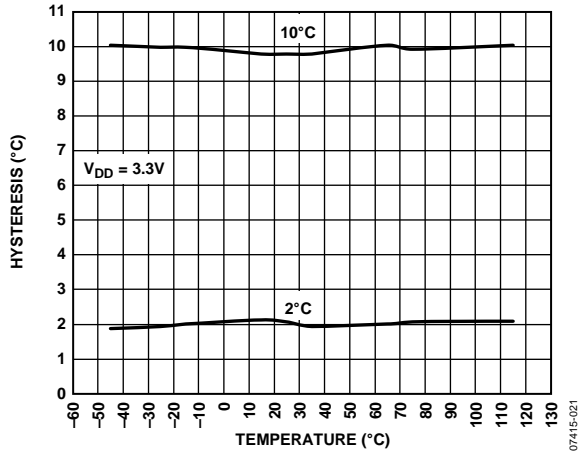

Figure 11. Hysteresis vs. Trip Temperature

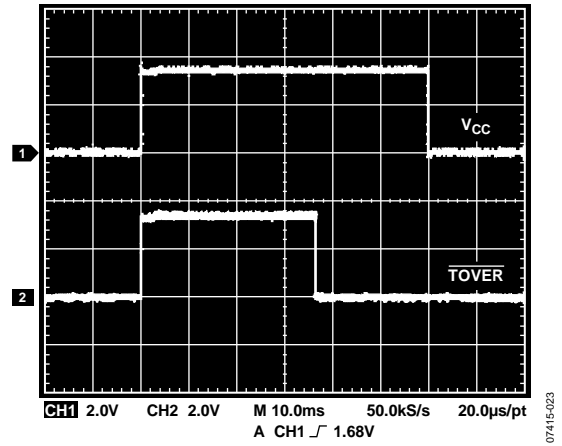

Figure 13. ADT6401 Start-Up Delay

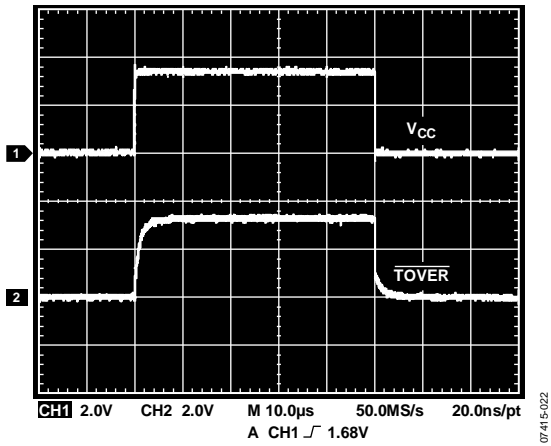

Figure 12. ADT6401 Start-Up and Power-Down Delay

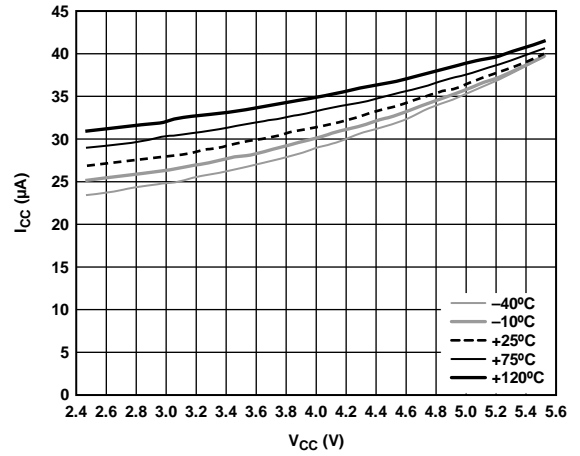

Figure 14. Operating Supply Current vs. Voltage Over Temperature

TYPICAL APPLICATION CIRCUITS

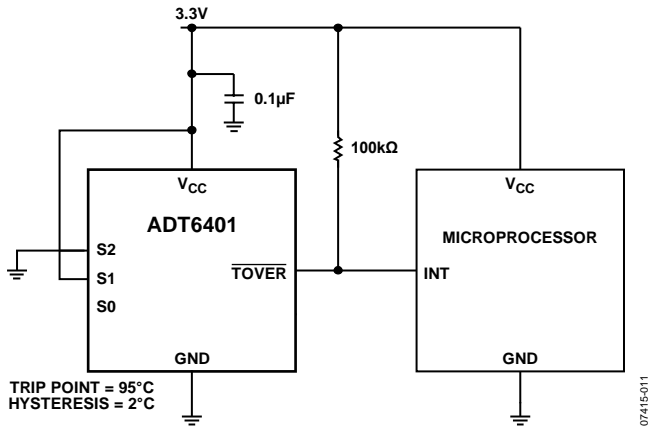

Figure 15. Microprocessor Alarm

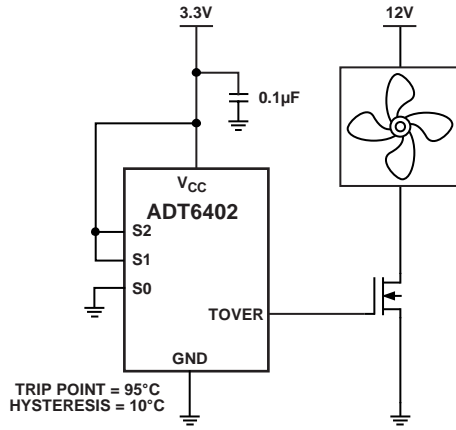

Figure 16. Overtemperature Fan Control

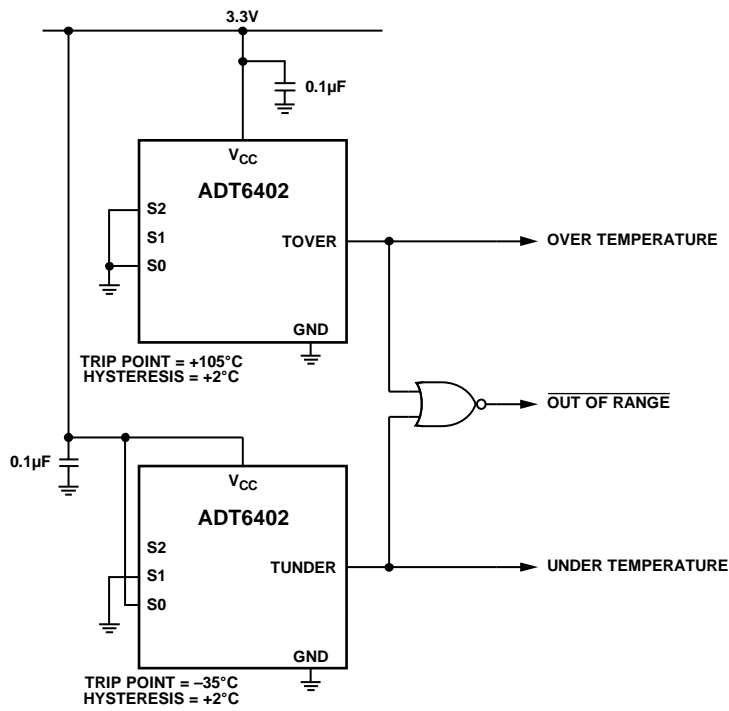

Figure 17. Temperature Window Alarms

THEORY OF OPERATION

CIRCUIT INFORMATION

The ADT6401/ADT6402 are 11-bit digital temperature sensors with a 12th bit acting as the sign bit. An on-board temperature sensor generates a voltage precisely proportional to absolute temperature, which is compared to an internal voltage reference and input to a precision digital modulator. The 12-bit output from the modulator is input into a digital comparator, where it is compared with a pin-selectable trip level. The output trip pin is activated if the temperature measured is greater than, or less than, the pin-selectable trip level. Overall accuracy for the ADT6401/ADT6402 is $\pm 6^{\circ}\text{C}$ (maximum) from -45°C to $+115^{\circ}\text{C}$.

The on-board temperature sensor has excellent accuracy and linearity over the entire rated temperature range without needing correction or calibration by the user. The ADT6401 has active low, open-drain output structures that can sink current. The ADT6402 has active high, push-pull output structures that can sink and source current. On power-up, the output becomes active when the first conversion is completed, which typically takes 30 ms.

The sensor output is digitized by a first-order, Σ - Δ modulator, also known as the charge balance type analog-to-digital converter (ADC). This type of converter utilizes time domain oversampling and a high accuracy comparator to deliver 11 bits of effective accuracy in an extremely compact circuit.

CONVERTER DETAILS

The Σ - Δ modulator consists of an input sampler, a summing network, an integrator, a comparator, and a 1-bit digital-to-analog converter (DAC). Similar to the voltage-to-frequency converter, this architecture creates a negative feedback loop and minimizes the integrator output by changing the duty cycle of the comparator output in response to input voltage changes. The comparator samples the output of the integrator at a much higher rate than the input sampling frequency; this is called oversampling. Oversampling spreads the quantization noise over a much wider band than that of the input signal, improving overall noise performance and increasing accuracy.

PIN-SELECTABLE TRIP POINT AND HYSTERESIS

The temperature trip point and hysteresis values for the ADT6401/ADT6402 are selected using Pin S0, Pin S1, and Pin S2. These three pins can be connected to V_{CC} , tied to GND, or left floating. The ADT6401/ADT6402 decode the inputs on S0, S1, and S2 to determine the temperature trip point and hysteresis value, as outlined in Table 4.

The ADT6401 overtemperature/undertemperature output is intended to interface to reset inputs of microprocessors. The ADT6402 is intended for driving circuits of applications, such as fan control circuits.

Table 4. Selecting Trip Points and Hysteresis¹

S2	S1	S0	Temperature Trip Point	Hysteresis
0	0	0	+45°C	2°C
0	0	1	+55°C	2°C
0	0	Float	+65°C	2°C
0	1	0	+75°C	2°C
0	1	1	+85°C	2°C
0	1	Float	+95°C	2°C
0	Float	0	+105°C	2°C
0	Float	1	+115°C	2°C
0	Float	Float	+55°C	10°C
1	0	0	+65°C	10°C
1	0	1	+75°C	10°C
1	0	Float	+85°C	10°C
1	1	0	+95°C	10°C
1	1	1	+105°C	10°C
1	1	Float	+115°C	10°C
1	Float	0	+5°C	2°C
1	Float	1	-5°C	2°C
1	Float	Float	-15°C	2°C
Float	0	0	-25°C	2°C
Float	0	1	-35°C	2°C
Float	0	Float	-45°C	2°C
Float	1	0	+5°C	10°C
Float	1	1	-5°C	10°C
Float	1	Float	-15°C	10°C
Float	Float	0	-25°C	10°C
Float	Float	1	-35°C	10°C
Float	Float	Float	-45°C	10°C

¹ 0 = pin tied to GND, 1 = pin tied to V_{CC} , Float = pin left floating.

Hysteresis

A hysteresis value of 2°C or 10°C can be selected. The digital comparator ensures excellent accuracy for the hysteresis value. Hysteresis prevents oscillation on the output pin when the temperature is approaching the trip point and after the output pin is activated. For example, if the temperature trip is 45°C and the hysteresis selected is 10°C, the temperature must go as low as 35°C before the output deactivates.

TEMPERATURE CONVERSION

The conversion clock for the part is generated internally. No external clock is required. The internal clock oscillator runs an automatic conversion sequence. During this automatic conversion sequence, a conversion is initiated every 600 ms. At this time, the part powers up its analog circuitry and performs a temperature conversion.

This temperature conversion typically takes 30 ms, after which the analog circuitry of the part automatically shuts down. The analog circuitry powers up again 570 ms later, when the 600 ms timer times out and the next conversion begins. The result of the most recent temperature conversion is compared with the factory-set trip point value. If the temperature measured is greater than the trip point value, the output is activated. The output is deactivated once the temperature crosses back over the trip point threshold, plus whatever temperature hysteresis is selected. Figure 18 to Figure 21 show the transfer function for the output trip pin of each generic model.

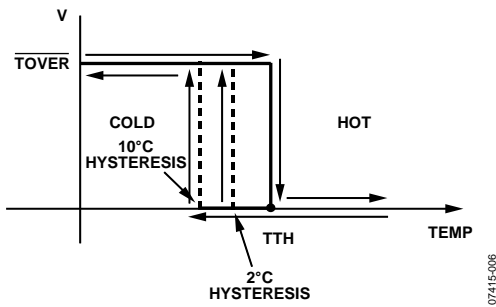

Figure 18. ADT6401 TOVER Transfer Function

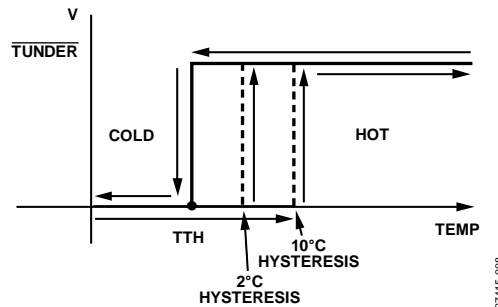

Figure 20. ADT6401 TUNDER Transfer Function

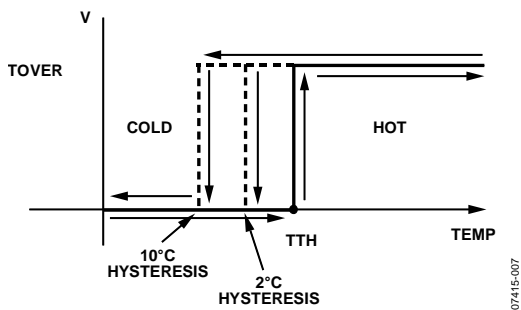

Figure 19. ADT6402 TOVER Transfer Function

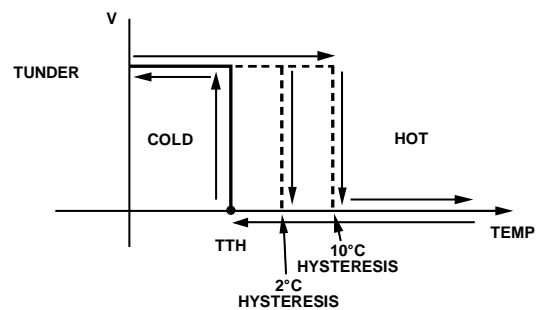

Figure 21. ADT6402 TUNDER Transfer Function

APPLICATIONS INFORMATION

THERMAL RESPONSE TIME

The time required for a temperature sensor to settle to a specified accuracy is a function of the thermal mass of the sensor and the thermal conductivity between the sensor and the object being sensed. Thermal mass is often considered equivalent to capacitance. Thermal conductivity is commonly specified using the symbol Q and can be thought of as thermal resistance. It is commonly specified in units of degrees per watt of power transferred across the thermal joint. Thus, the time required for the ADT6401/ADT6402 to settle to the desired accuracy is dependent on the characteristics of the SOT-23 package, the thermal contact established in that particular application, and the equivalent power of the heat source. In most applications, the settling time is best determined empirically.

SELF-HEATING EFFECTS

The temperature measurement accuracy of the ADT6401/ADT6402 can be degraded in some applications due to self-heating. Errors can be introduced from the quiescent dissipation and power dissipated when converting. The magnitude of these temperature errors depends on the thermal conductivity of the ADT6401/ADT6402 package, the mounting technique, and the effects of airflow. At 25°C, static dissipation in the ADT6401/ADT6402 is typically 99 μW operating at 3.3 V. In the 6-lead SOT-23 package mounted in free air, this accounts for a temperature increase due to self-heating of

$$\Delta T = P_{DISS} \times \theta_{JA} = 99 \mu\text{W} \times 240^\circ\text{C}/\text{W} = 0.024^\circ\text{C}$$

It is recommended that current dissipated through the device be kept to a minimum because it has a proportional effect on the temperature error.

SUPPLY DECOUPLING

The ADT6401/ADT6402 should be decoupled with a 0.1 μF ceramic capacitor between V_{CC} and GND. This is particularly important when the ADT6401/ADT6402 are mounted remotely from the power supply. Precision analog products such as the ADT6401/ADT6402 require well-filtered power sources. Because the ADT6401/ADT6402 operate from a single supply, it may seem convenient to tap into the digital logic power supply. Unfortunately, the logic supply is often a switch-mode design, which generates noise in the 20 kHz to 1 MHz range. In addition, fast logic gates can generate glitches that are hundreds of millivolts in amplitude due to wiring resistance and inductance.

If possible, the ADT6401/ADT6402 should be powered directly from the system power supply. This arrangement, shown in Figure 22, isolates the analog section from the logic-switching transients. Even if a separate power supply trace is not available, generous supply bypassing reduces supply line induced errors. Local supply bypassing consisting of a 0.1 μF ceramic capacitor is advisable to achieve the temperature accuracy specifications. This decoupling capacitor must be placed as close as possible to the ADT6401/ADT6402 V_{CC} pin.

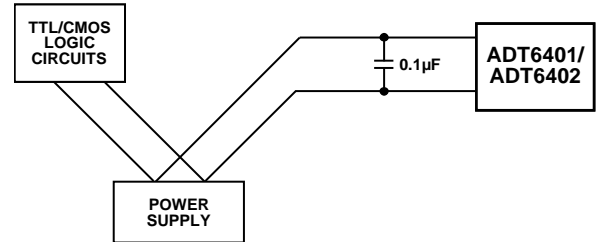

Figure 22. Separate Traces Used to Reduce Power Supply Noise

07415-010

TEMPERATURE MONITORING

The ADT6401/ADT6402 are ideal for monitoring the thermal environment within electronic equipment. For example, the surface-mount package accurately reflects the exact thermal conditions that affect nearby integrated circuits.

The ADT6401/ADT6402 measure and convert the temperature at the surface of its own semiconductor chip. When the ADT6401/ADT6402 are used to measure the temperature of a nearby heat source, the thermal impedance between the heat source and the ADT6401/ADT6402 must be as low as possible.

As much as 60% of the heat transferred from the heat source to the thermal sensor on the ADT6401/ADT6402 die is discharged via the copper tracks, package pins, and bond pads. Of the pins on the ADT6401/ADT6402, the GND pin transfers most of the heat. Therefore, to monitor the temperature of a heat source, it is recommended that the thermal resistance between the ADT6401/ADT6402 GND pin and the GND of the heat source be reduced as much as possible.

For example, the unique properties of the ADT6401/ADT6402 can be used to monitor a high power dissipation microprocessor. The ADT6401/ADT6402 device in its SOT-23 package is mounted directly beneath the pin grid array (PGA) package of the microprocessor. The ADT6401/ADT6402 require no external characterization.

OUTLINE DIMENSIONS

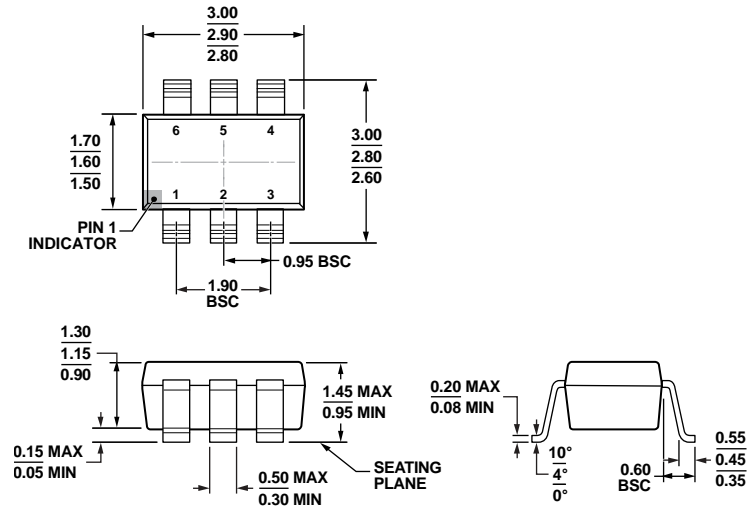

COMPLIANT TO JEDEC STANDARDS MO-178-AB
 Figure 23. 6-Lead Small Outline Transistor Package [SOT-23]
 (RJ-6)
 Dimensions shown in millimeters

12-16-2008-A

ORDERING GUIDE

Model ¹	Temperature Range	Package Description	Package Option	Ordering Quantity	Branding
ADT6401SRJZ-RL7	-55°C to +125°C	6-Lead SOT-23	RJ-6	3,000	T30
ADT6402SRJZ-RL7	-55°C to +125°C	6-Lead SOT-23	RJ-6	3,000	T32

¹ Z = RoHS Compliant Part.

Mouser Electronics

Authorized Distributor

Click to View Pricing, Inventory, Delivery & Lifecycle Information:

[Analog Devices Inc.:](#)

[ADT6402SRJZ-RL7](#)