

### FEATURES

#### Supply range

2.8 V to 15 V, ADR291

4.4 V to 15 V, ADR292

#### Supply current: 15 $\mu$ A maximum

Low noise: 8  $\mu$ V and 12  $\mu$ V p-p (0.1 Hz to 10 Hz)

High output current: 5 mA

Temperature range:  $-40^{\circ}\text{C}$  to  $+125^{\circ}\text{C}$

Pin-compatible with REF02/REF19x

### APPLICATIONS

Portable instrumentation

Precision reference for 3 V and 5 V systems

Analog-to-digital and digital-to-analog converter reference

Solar-powered applications

Loop-current-powered instruments

### GENERAL DESCRIPTION

The ADR291 and ADR292 are low noise, micropower precision voltage references that use an XFET<sup>®</sup> reference circuit. The new XFET architecture offers significant performance improvements over traditional band gap and buried Zener-based references. Improvements include one quarter the voltage noise output of band gap references operating at the same current, very low and ultralinear temperature drift, low thermal hysteresis, and excellent long-term stability.

The ADR291/ADR292 family is a series of voltage references providing stable and accurate output voltages from supplies as low as 2.8 V for the ADR291. Output voltage options are 2.5 V and 4.096 V for the ADR291 and ADR292, respectively.

Quiescent current is only 12  $\mu$ A, making these devices ideal for battery-powered instrumentation. Three electrical grades are available offering initial output accuracies of  $\pm 2$  mV,  $\pm 3$  mV, and  $\pm 6$  mV maximum for the ADR291, and  $\pm 3$  mV,  $\pm 4$  mV, and  $\pm 6$  mV maximum for the ADR292. Temperature

coefficients for the three grades are 8 ppm/ $^{\circ}\text{C}$ , 15 ppm/ $^{\circ}\text{C}$ , and 25 ppm/ $^{\circ}\text{C}$  maximum, respectively. Line regulation and load regulation are typically 30 ppm/V and 30 ppm/mA, maintaining the reference's overall high performance. For a device with 5.0 V output, refer to the ADR293 data sheet.

The ADR291 and ADR292 references are specified over the extended industrial temperature range of  $-40^{\circ}\text{C}$  to  $+125^{\circ}\text{C}$ . Devices are available in the 8-lead SOIC, 8-lead TSSOP, and 3-lead TO-92 packages.

Table 1. ADR291/ADR292 Product

Part No.	Output Voltage (V)	Initial Accuracy ( $\pm\%$ )	Temperature Coefficient (ppm/ $^{\circ}\text{C}$ ) Max
ADR291	2.500	0.08, 0.12, 0.24	8, 15, 25
ADR292	4.096	0.07, 0.10, 0.15	8, 15, 25

### CONNECTION DIAGRAMS

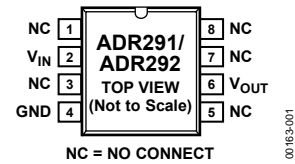

Figure 1. 8-Lead SOIC (R-8)

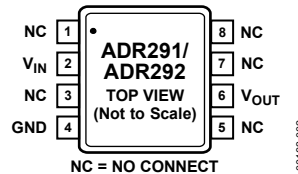

Figure 2. 8-Lead TSSOP (RU-8)

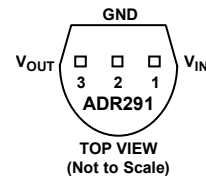

Figure 3. 3-Lead TO-92 (T-3)

#### Rev. F

Information furnished by Analog Devices is believed to be accurate and reliable. However, no responsibility is assumed by Analog Devices for its use, nor for any infringements of patents or other rights of third parties that may result from its use. Specifications subject to change without notice. No license is granted by implication or otherwise under any patent or patent rights of Analog Devices. Trademarks and registered trademarks are the property of their respective owners.

## TABLE OF CONTENTS

Features .....	1	Theory of Operation .....	13
Applications.....	1	Device Power Dissipation Considerations.....	13
Connection Diagrams.....	1	Basic Voltage Reference Connections .....	13
General Description .....	1	Noise Performance .....	13
Revision History .....	2	Turn-On Time .....	13
Specifications.....	3	Applications Information .....	14
ADR291 Electrical Specifications.....	3	High Voltage Floating Current Source .....	14
ADR292 Electrical Specifications.....	4	Kelvin Connections.....	14
Absolute Maximum Ratings.....	6	Low Power, Low Voltage Reference for Data Converters .....	14
ESD Caution.....	6	Voltage Regulator for Portable Equipment .....	15
Pin Configurations and Function Descriptions .....	7	Outline Dimensions .....	16
Typical Performance Characteristics .....	8	Ordering Guide .....	17
Terminology .....	12		

## REVISION HISTORY

### 5/11—Rev. E to Rev. F

Deleted Negative Precision Reference Without Precision Resistors Section .....	14
Deleted Figure 33 and Figure 34, Renumbered Sequentially ...	14
Changes to Ordering Guide .....	17

### 12/07—Rev. D to Rev. E

Changes to Features.....	1
Changes to Figure 34.....	14

### 3/06—Rev. C to Rev. D

Updated Format.....	Universal
Change to Table 8 .....	6
Updated Outline Dimensions .....	15
Changes to Ordering Guide .....	16

### 9/03—Rev. B to Rev. C

Deleted ADR290.....	Universal
Changes to Specifications.....	2
Changes to Ordering Guide .....	4
Updated Outline Dimensions .....	13

## SPECIFICATIONS

### ADR291 ELECTRICAL SPECIFICATIONS

$V_S = 3.0\text{ V to }15\text{ V}$ ,  $T_A = 25^\circ\text{C}$ , unless otherwise noted.

Table 2.

Parameter	Symbol	Conditions	Min	Typ	Max	Unit
E GRADE						
Output Voltage	$V_{OUT}$	$I_{OUT} = 0\text{ mA}$	2.498	2.500	2.502	V
Initial Accuracy	$V_{OERR}$		-2		+2	mV
			-0.08		+0.08	%
F GRADE						
Output Voltage	$V_{OUT}$	$I_{OUT} = 0\text{ mA}$	2.497	2.500	2.503	V
Initial Accuracy	$V_{OERR}$		-3		+3	mV
			-0.12		+0.12	%
G GRADE						
Output Voltage	$V_{OUT}$	$I_{OUT} = 0\text{ mA}$	2.494	2.500	2.506	V
Initial Accuracy	$V_{OERR}$		-6		+6	mV
			-0.24		+0.24	%
LINE REGULATION						
E/F Grades	$\Delta V_{OUT}/\Delta V_{IN}$	$I_{OUT} = 0\text{ mA}$		30	100	ppm/V
G Grade				40	125	ppm/V
LOAD REGULATION						
E/F Grades	$\Delta V_{OUT}/\Delta I_{LOAD}$	$V_S = 5.0\text{ V}$ , $I_{OUT} = 0\text{ mA to }5\text{ mA}$		30	100	ppm/mA
G Grade				40	125	ppm/mA
LONG-TERM STABILITY	$\Delta V_{OUT}$	After 1000 hours of operation @ $125^\circ\text{C}$		50		ppm
NOISE VOLTAGE	$e_N$	0.1 Hz to 10 Hz		8		$\mu\text{V p-p}$
WIDEBAND NOISE DENSITY	$e_N$	@ 1 kHz		480		$\text{nV}/\sqrt{\text{Hz}}$

$V_S = 3.0\text{ V to }15\text{ V}$ ,  $T_A = -25^\circ\text{C to }+85^\circ\text{C}$ , unless otherwise noted.

Table 3.

Parameter	Symbol	Conditions	Min	Typ	Max	Unit
TEMPERATURE COEFFICIENT						
E Grade	$TCV_{OUT}$	$I_{OUT} = 0\text{ mA}$		3	8	ppm/ $^\circ\text{C}$
F Grade				5	15	ppm/ $^\circ\text{C}$
G Grade				10	25	ppm/ $^\circ\text{C}$
LINE REGULATION						
E/F Grades	$\Delta V_{OUT}/\Delta V_{IN}$	$I_{OUT} = 0\text{ mA}$		35	125	ppm/V
G Grade				50	150	ppm/V
LOAD REGULATION						
E/F Grades	$\Delta V_{OUT}/\Delta I_{LOAD}$	$V_S = 5.0\text{ V}$ , $I_{OUT} = 0\text{ mA to }5\text{ mA}$		20	125	ppm/mA
G Grade				30	150	ppm/mA

# ADR291/ADR292

$V_S = 3.0\text{ V to }15\text{ V}$ ,  $T_A = -40^\circ\text{C to }+125^\circ\text{C}$ , unless otherwise noted.

**Table 4.**

Parameter	Symbol	Conditions	Min	Typ	Max	Unit
TEMPERATURE COEFFICIENT						
E Grade	$TCV_{OUT}$	$I_{OUT} = 0\text{ mA}$		3	10	ppm/°C
F Grade				5	20	ppm/°C
G Grade				10	30	ppm/°C
LINE REGULATION						
E/F Grades	$\Delta V_{OUT}/\Delta V_{IN}$	$I_{OUT} = 0\text{ mA}$		40	200	ppm/V
G Grade				70	250	ppm/V
LOAD REGULATION						
E/F Grades	$\Delta V_{OUT}/\Delta I_{LOAD}$	$V_S = 5.0\text{ V}$ , $I_{OUT} = 0\text{ mA to }5\text{ mA}$		20	200	ppm/mA
G Grade				30	300	ppm/mA
SUPPLY CURRENT	$I_S$	$T_A = 25^\circ\text{C}$ $-40^\circ\text{C} \leq T_A \leq +125^\circ\text{C}$		9	12	$\mu\text{A}$
				12	15	$\mu\text{A}$
THERMAL HYSTERESIS	$V_{OUT-HYS}$	8-lead SOIC, 8-lead TSSOP		50		ppm

## ADR292 ELECTRICAL SPECIFICATIONS

$V_S = 5\text{ V to }15\text{ V}$ ,  $T_A = 25^\circ\text{C}$ , unless otherwise noted.

**Table 5.**

Parameter	Symbol	Conditions	Min	Typ	Max	Unit
E GRADE						
Output Voltage	$V_{OUT}$	$I_{OUT} = 0\text{ mA}$	4.093	4.096	4.099	V
Initial Accuracy	$V_{OERR}$		-3		+3	mV
			-0.07		+0.07	%
F GRADE						
Output Voltage	$V_{OUT}$	$I_{OUT} = 0\text{ mA}$	4.092	4.096	4.1	V
Initial Accuracy	$V_{OERR}$		-4		+4	mV
			-0.10		+0.10	%
G GRADE						
Output Voltage	$V_{OUT}$	$I_{OUT} = 0\text{ mA}$	4.090	4.096	4.102	V
Initial Accuracy	$V_{OERR}$		-6		+6	mV
			-0.15		+0.15	%
LINE REGULATION						
E/F Grades	$\Delta V_{OUT}/\Delta V_{IN}$	$V_S = 4.5\text{ V to }15\text{ V}$ , $I_{OUT} = 0\text{ mA}$		30	100	ppm/V
G Grade				40	125	ppm/V
LOAD REGULATION						
E/F Grades	$\Delta V_{OUT}/\Delta I_{LOAD}$	$V_S = 5.0\text{ V}$ , $I_{OUT} = 0\text{ mA to }5\text{ mA}$		30	100	ppm/mA
G Grade				40	125	ppm/mA
LONG-TERM STABILITY	$\Delta V_{OUT}$	After 1000 hours of operation @ $125^\circ\text{C}$		50		ppm
NOISE VOLTAGE	$e_N$	0.1 Hz to 10 Hz		12		$\mu\text{V p-p}$
WIDEBAND NOISE DENSITY	$e_N$	@ 1 kHz		640		$\text{nV}/\sqrt{\text{Hz}}$

$V_S = 5\text{ V to }15\text{ V}$ ,  $T_A = -25^\circ\text{C to }+85^\circ\text{C}$ , unless otherwise noted.

**Table 6.**

Parameter	Symbol	Conditions	Min	Typ	Max	Unit
TEMPERATURE COEFFICIENT						
E Grade	TCV <sub>OUT</sub>	I <sub>OUT</sub> = 0 mA		3	8	ppm/°C
F Grade				5	15	ppm/°C
G Grade				10	25	ppm/°C
LINE REGULATION						
E/F Grades	$\Delta V_{OUT}/\Delta V_{IN}$	$V_S = 4.5\text{ V to }15\text{ V}$ , I <sub>OUT</sub> = 0 mA		35	125	ppm/V
G Grade				50	150	ppm/V
LOAD REGULATION						
E/F Grades	$\Delta V_{OUT}/\Delta I_{LOAD}$	$V_S = 5.0\text{ V}$ , I <sub>OUT</sub> = 0 mA to 5 mA		20	125	ppm/mA
G Grade				30	150	ppm/mA

$V_S = 5\text{ V to }15\text{ V}$ ,  $T_A = -40^\circ\text{C to }+125^\circ\text{C}$ , unless otherwise noted.

**Table 7.**

Parameter	Symbol	Conditions	Min	Typ	Max	Unit
TEMPERATURE COEFFICIENT						
E Grade	TCV <sub>OUT</sub>	I <sub>OUT</sub> = 0 mA		3	10	ppm/°C
F Grade				5	20	ppm/°C
G Grade				10	30	ppm/°C
LINE REGULATION						
E/F Grades	$\Delta V_{OUT}/\Delta V_{IN}$	$V_S = 4.5\text{ V to }15\text{ V}$ , I <sub>OUT</sub> = 0 mA		40	200	ppm/V
G Grade				70	250	ppm/V
LOAD REGULATION						
E/F Grades	$\Delta V_{OUT}/\Delta I_{LOAD}$	$V_S = 5.0\text{ V}$ , I <sub>OUT</sub> = 0 mA to 5 mA		20	200	ppm/mA
G Grade				30	300	ppm/mA
SUPPLY CURRENT	I <sub>S</sub>	T <sub>A</sub> = 25°C -40°C ≤ T <sub>A</sub> ≤ +125°C		10 12	15 18	μA μA
THERMAL HYSTERESIS	V <sub>OUT-HYS</sub>	8-lead SOIC, 8-lead TSSOP		50		ppm

## ABSOLUTE MAXIMUM RATINGS

Remove power before inserting or removing units from their sockets.

**Table 8.**

Parameter	Rating
Supply Voltage	18 V
Output Short-Circuit Duration to GND	Indefinite
Storage Temperature Range T, R, RU Packages	-65°C to +150°C
Operating Temperature Range ADR291/ADR292	-40°C to +125°C
Junction Temperature Range T, R, RU Packages	-65°C to +125°C
Lead Temperature (Soldering, 60 sec)	300°C

Stresses above those listed under Absolute Maximum Ratings may cause permanent damage to the device. This is a stress rating only; functional operation of the device at these or any other conditions above those indicated in the operational section of this specification is not implied. Exposure to absolute maximum rating conditions for extended periods may affect device reliability.

**Table 9. Package Types**

Package Type	$\theta_{JA}^1$	$\theta_{JC}$	Unit
8-Lead SOIC (R)	158	43	°C/W
8-Lead TSSOP (RU)	240	43	°C/W
3-Lead TO-92 (T)	160	–	°C/W

<sup>1</sup> $\theta_{JA}$  is specified for worst-case conditions. For example,  $\theta_{JA}$  is specified for a device in socket testing. In practice,  $\theta_{JA}$  is specified for a device soldered in the circuit board.

**Table 10. Other XFET Products**

Part Number	Nominal Output Voltage (V)	Package Type
<a href="#">ADR420</a>	2.048	8-Lead MSOP/SOIC
<a href="#">ADR421</a>	2.50	8-Lead MSOP/SOIC
<a href="#">ADR423</a>	3.0	8-Lead MSOP/SOIC
<a href="#">ADR425</a>	5.0	8-Lead MSOP/SOIC

### ESD CAUTION



**ESD (electrostatic discharge) sensitive device.**

Charged devices and circuit boards can discharge without detection. Although this product features patented or proprietary protection circuitry, damage may occur on devices subjected to high energy ESD. Therefore, proper ESD precautions should be taken to avoid performance degradation or loss of functionality.

## PIN CONFIGURATIONS AND FUNCTION DESCRIPTIONS

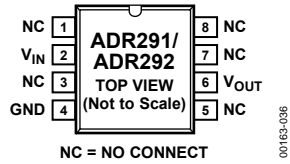

Figure 4. 8-Lead SOIC (R-8)

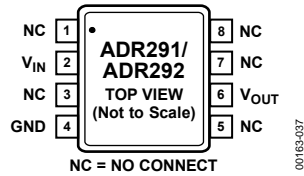

Figure 5. 8-Lead TSSOP (RU-8)

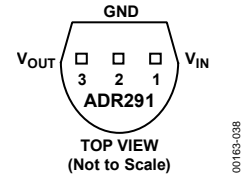

Figure 6. 3-Lead TO-92 (T-3)

Table 11. Pin Function Descriptions

Pin No.			Mnemonic	Description
SOIC	TSSOP	TO-92		
1, 3, 5, 7, 8	1, 3, 5, 7, 8	N/A	NC	No Connect
2	2	1	V <sub>IN</sub>	Input Voltage
4	4	2	GND	Ground
6	6	3	V <sub>OUT</sub>	Output Voltage

## TYPICAL PERFORMANCE CHARACTERISTICS

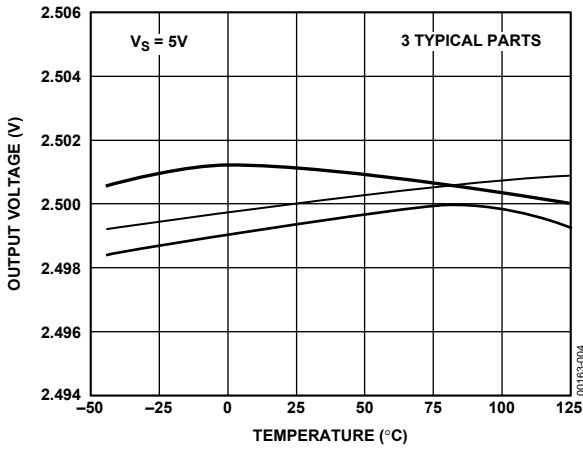

Figure 7. ADR291  $V_{OUT}$  vs. Temperature

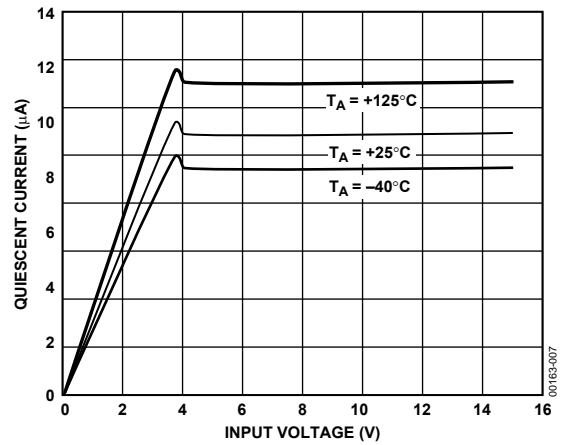

Figure 10. ADR292 Quiescent Current vs. Input Voltage

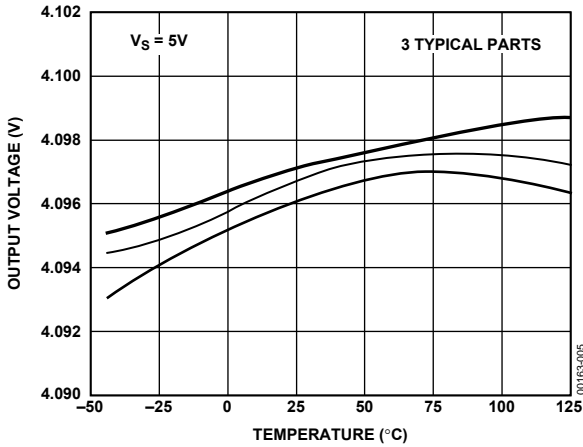

Figure 8. ADR292  $V_{OUT}$  vs. Temperature

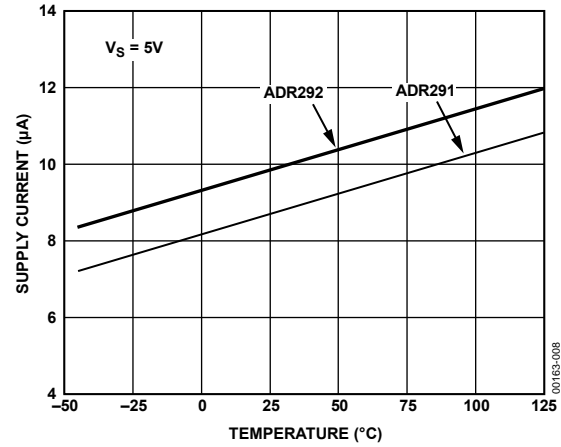

Figure 11. ADR291/ADR292 Supply Current vs. Temperature

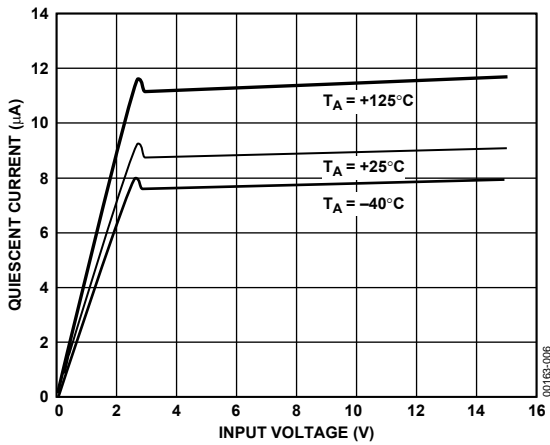

Figure 9. ADR291 Quiescent Current vs. Input Voltage

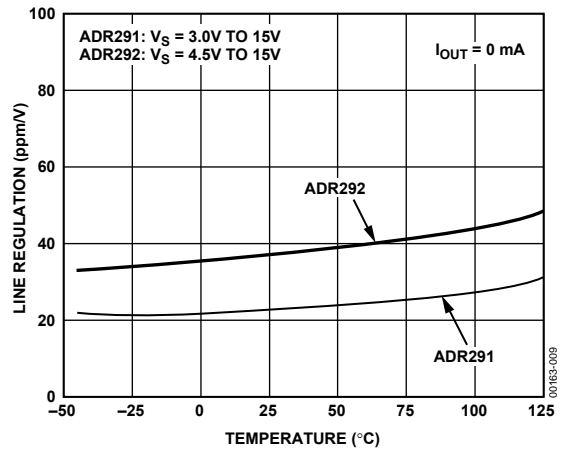

Figure 12. ADR291/ADR292 Line Regulation vs. Temperature



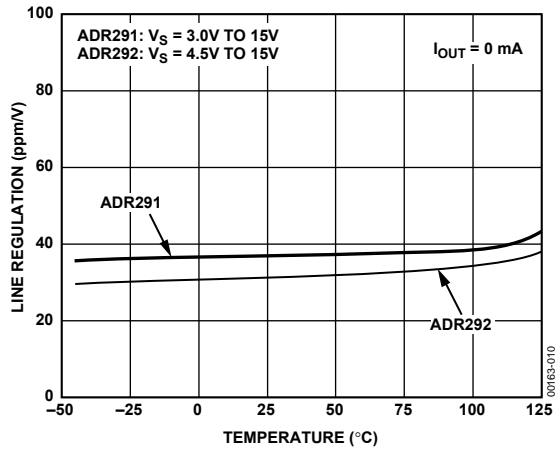

Figure 13. ADR291/ADR292 Line Regulation vs. Temperature

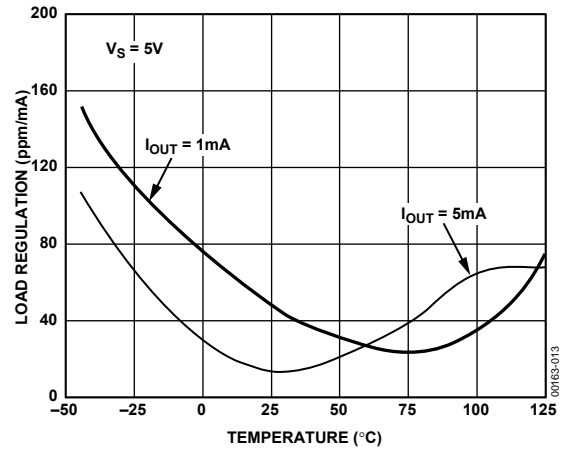

Figure 16. ADR291 Load Regulation vs. Temperature

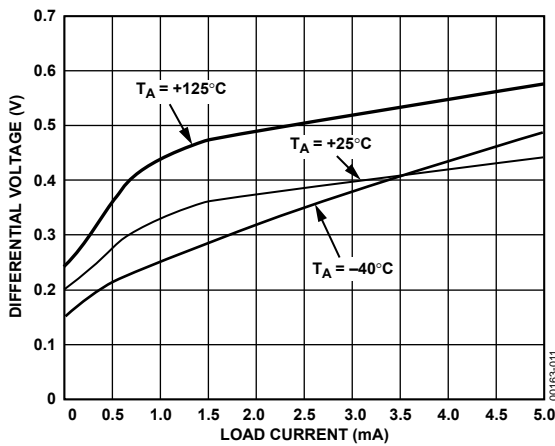

Figure 14. ADR291 Minimum Input-Output Voltage Differential vs. Load Current

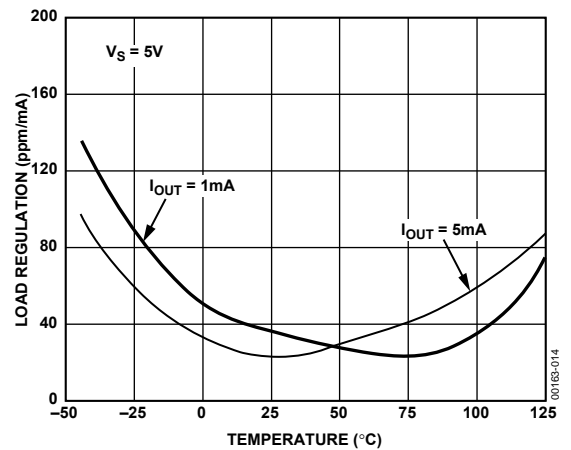

Figure 17. ADR292 Load Regulation vs. Temperature

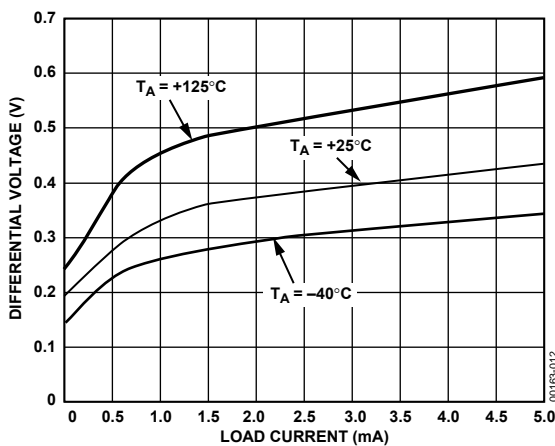

Figure 15. ADR292 Minimum Input-Output Voltage Differential vs. Load Current

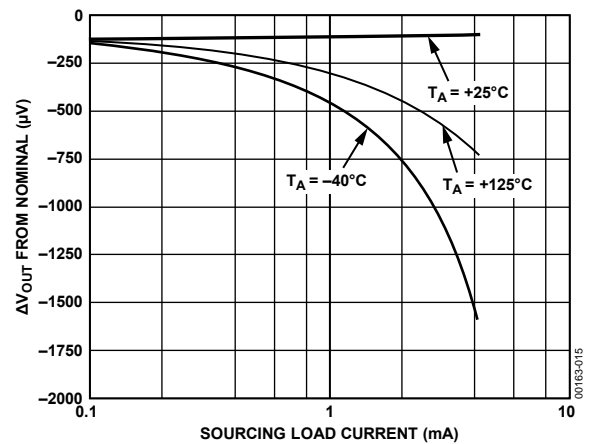

Figure 18. ADR291  $\Delta V_{OUT}$  from Nominal vs. Load Current

# ADR291/ADR292

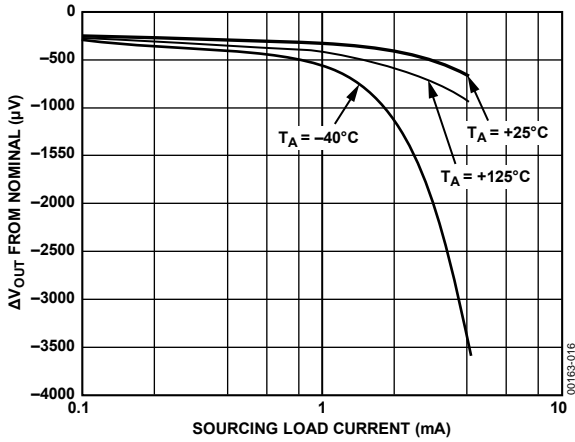

Figure 19. ADR292  $\Delta V_{OUT}$  from Nominal vs. Load Current

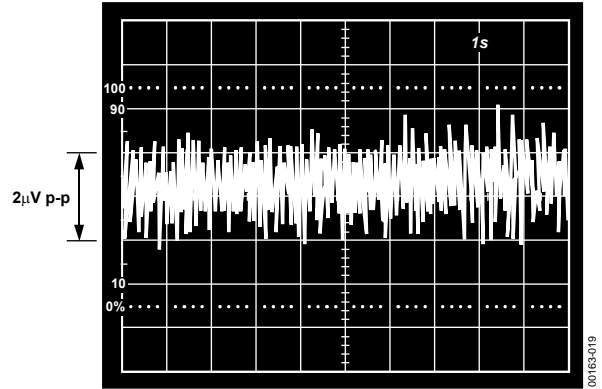

Figure 22. ADR291 0.1 Hz to 10 Hz Noise

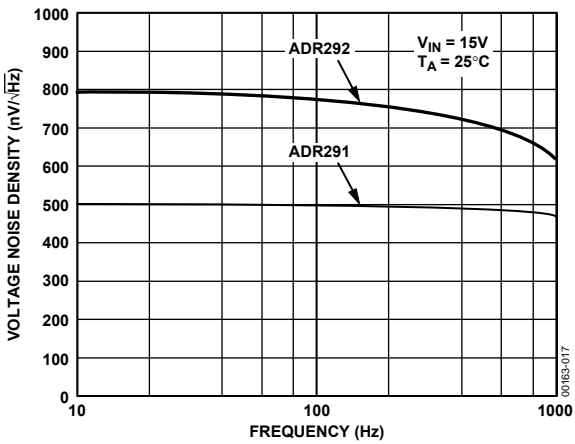

Figure 20. Voltage Noise Density vs. Frequency

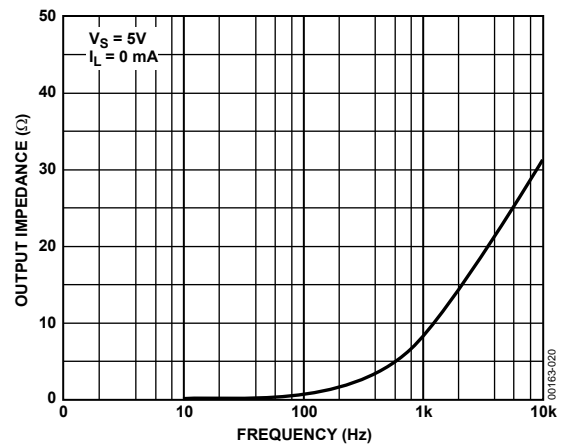

Figure 23. ADR291 Output Impedance vs. Frequency

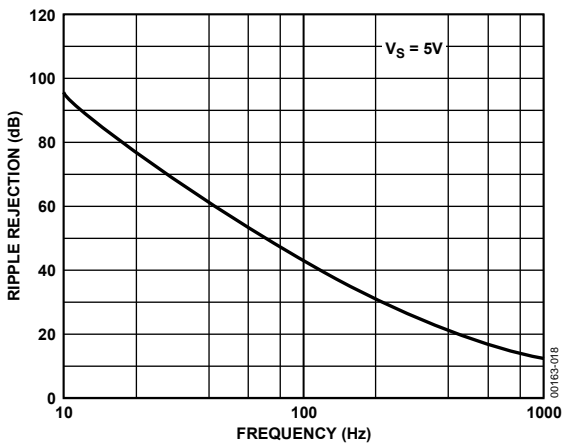

Figure 21. ADR291/ADR292 Ripple Rejection vs. Frequency

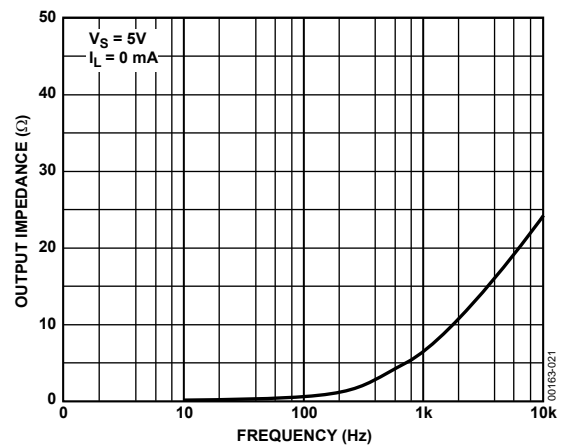

Figure 24. ADR292 Output Impedance vs. Frequency

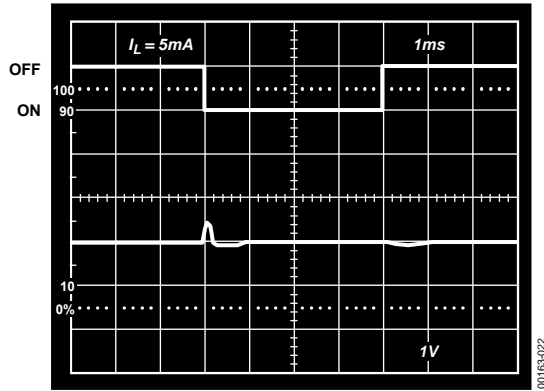

Figure 25. ADR291 Load Transient

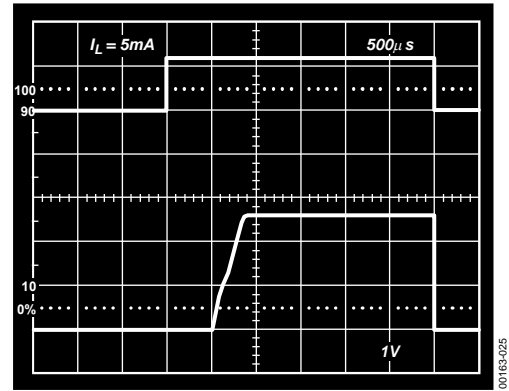

Figure 28. ADR291 Turn-On Time

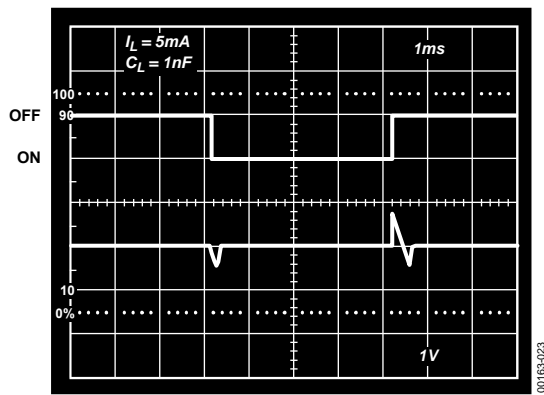

Figure 26. ADR291 Load Transient

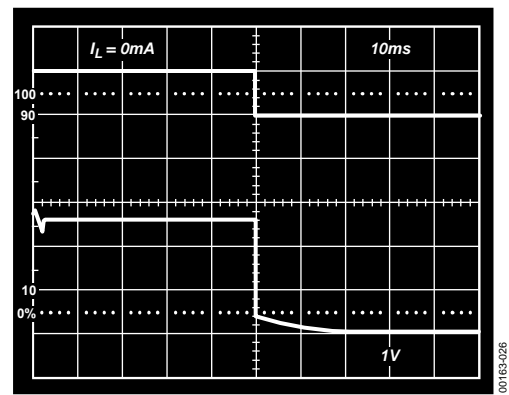

Figure 29. ADR291 Turn-Off Time

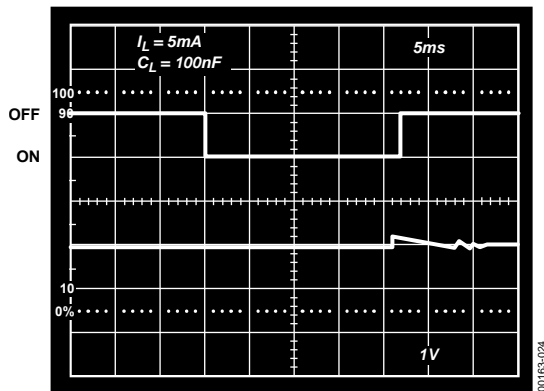

Figure 27. ADR291 Load Transient

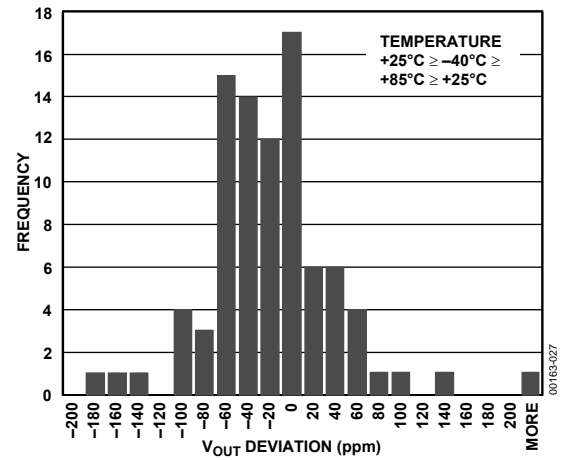

Figure 30. Typical Hysteresis for the ADR291 Product

## TERMINOLOGY

### Line Regulation

Line regulation refers to the change in output voltage due to a specified change in input voltage. It includes the effects of self-heating. Line regulation is expressed as percent-per-volt, parts-per-million-per-volt, or microvolts-per-volt change in input voltage.

### Load Regulation

The change in output voltage is due to a specified change in load current and includes the effects of self-heating. Load regulation is expressed in microvolts-per-milliampere, parts-per-million-per-milliampere, or ohms of dc output resistance.

### Long-Term Stability

Long-term stability refers to the typical shift of output voltage at 25°C on a sample of parts subjected to a test of 1000 hours at 125°C.

$$\Delta V_{OUT} = V_{OUT}(t_0) - V_{OUT}(t_1)$$

$$\Delta V_{OUT} [\text{ppm}] = \frac{V_{OUT}(t_0) - V_{OUT}(t_1)}{V_{OUT}(t_0)} \times 10^6$$

where:

$V_{OUT}(t_0)$  =  $V_{OUT}$  at 25°C at Time 0.

$V_{OUT}(t_1)$  =  $V_{OUT}$  at 25°C after 1000 hours of operation at 125°C.

### Temperature Coefficient

Temperature coefficient is the change of output voltage over the operating temperature change, normalized by the output voltage at 25°C, expressed in ppm/°C. The equation follows:

$$TCV_o [\text{ppm}/^\circ\text{C}] = \frac{V_o(T_2) - V_o(T_1)}{V_o(25^\circ\text{C}) \times (T_2 - T_1)} \times 10^6$$

where:

$V_{OUT}(25^\circ\text{C})$  =  $V_{OUT}$  at 25°C.

$V_{OUT}(T_1)$  =  $V_{OUT}$  at Temperature 1.

$V_{OUT}(T_2)$  =  $V_{OUT}$  at Temperature 2.

### NC = no connect.

There are internal connections at NC pins that are reserved for manufacturing purposes. Users should not connect anything at the NC pins.

### Thermal Hysteresis

Thermal hysteresis is defined as the change of output voltage after the device is cycled through temperatures from +25°C to -40°C, then to +85°C, and back to +25°C. This is a typical value from a sample of parts put through such a cycle.

$$V_{OUT-HYS} = V_{OUT}(25^\circ\text{C}) - V_{OUT\_TC}$$

$$V_{OUT-HYS} [\text{ppm}] = \frac{V_{OUT}(25^\circ\text{C}) - V_{OUT\_TC}}{V_{OUT}(25^\circ\text{C})} \times 10^6$$

where:

$V_{OUT}(25^\circ\text{C})$  =  $V_{OUT}$  at 25°C.

$V_{OUT\_TC}$  =  $V_{OUT}$  at 25°C after temperature cycle from +25°C to -40°C, then to +85°C, and back to +25°C.

## THEORY OF OPERATION

The ADR291/ADR292 series of references uses a reference generation technique known as XFET (eXtra implanted junction FET). This technique yields a reference with low noise, low supply current, and very low thermal hysteresis.

The core of the XFET reference consists of two junction field effect transistors, one having an extra channel implant to raise its pinch-off voltage. By running the two JFETs at the same drain current, the difference in pinch-off voltage can be amplified and used to form a highly stable voltage reference. The intrinsic reference voltage is around 0.5 V with a negative temperature coefficient of about -120 ppm/K. This slope is essentially locked to the dielectric constant of silicon and can be closely compensated by adding a correction term generated in the same fashion as the proportional-to-temperature (PTAT) term used to compensate band gap references. Because most of the noise of a band gap reference comes from the compensation circuitry, the intrinsic temperature coefficient offers a significant advantage (being about 30 times lower), and therefore, requiring less correction resulting in much lower noise.

The simplified schematic in Figure 31 shows the basic topology of the ADR291/ADR292 series. The temperature correction term is provided by a current source with a value designed to be proportional to absolute temperature. The general equation is

$$V_{OUT} = \Delta V_P \left( \frac{R1 + R2 + R3}{R1} \right) + (I_{PTAT})(R3)$$

where:

$\Delta V_P$  is the difference in pinch-off voltage between the two FETs.  
 $I_{PTAT}$  is the positive temperature coefficient correction current.

The various versions of the ADR291/ADR292 family are created by on-chip adjustment of R1 and R3 to achieve 2.500 V or 4.096 V at the reference output.

The process used for the XFET reference also features vertical NPN and PNP transistors, the latter of which are used as output devices to provide a very low dropout voltage.

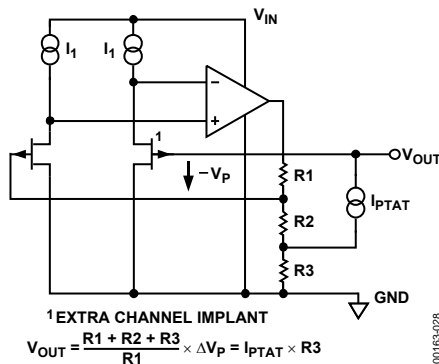

Figure 31. ADR291/ADR292 Simplified Schematic

## DEVICE POWER DISSIPATION CONSIDERATIONS

The ADR291/ADR292 family of references is guaranteed to deliver load currents to 5 mA with an input voltage that ranges from 2.7 V to 15 V (minimum supply voltage depends on the output voltage chosen). When these devices are used in applications with large input voltages, care should be exercised to avoid exceeding the published specifications for maximum power dissipation or junction temperature that could result in premature device failure. Use the following formula to calculate maximum junction temperature or dissipation of a device:

$$P_D = \frac{T_J - T_A}{\theta_{JA}}$$

where

$T_J$  and  $T_A$  are the junction and ambient temperatures, respectively.

$P_D$  is the device power dissipation.

$\theta_{JA}$  is the device package thermal resistance.

## BASIC VOLTAGE REFERENCE CONNECTIONS

References, in general, require a bypass capacitor connected from the  $V_{OUT}$  pin to the GND pin. The circuit in Figure 32 illustrates the basic configuration for the ADR291/ADR292 family of references. Note that the decoupling capacitors are not required for circuit stability.

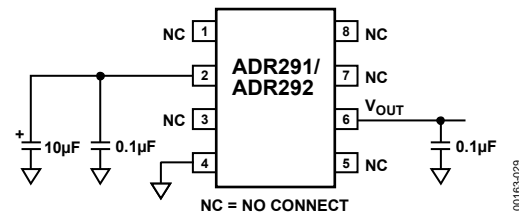

Figure 32. Basic Voltage Reference Configuration

## NOISE PERFORMANCE

The noise generated by the ADR291/ADR292 family of references is typically less than 12 µV p-p over the 0.1 Hz to 10 Hz band. The noise measurement is made with a band-pass filter made of a 2-pole high-pass filter with a corner frequency at 0.1 Hz and a 2-pole low-pass filter with a corner frequency at 10 Hz.

## TURN-ON TIME

Upon application of power (cold start), the time required for the output voltage to reach its final value within a specified error band is defined as the turn-on settling time. Two components normally associated with this are the time it takes for the active circuits to settle and for the thermal gradients on the chip to stabilize. Figure 28 shows the turn-on settling time for the ADR291.

## APPLICATIONS INFORMATION

### HIGH VOLTAGE FLOATING CURRENT SOURCE

The circuit shown in Figure 33 can be used to generate a floating current source with minimal self-heating. This particular configuration operates on high supply voltages determined by the breakdown voltage of the N-channel JFET.

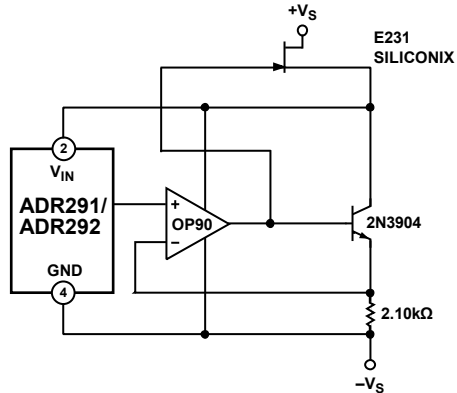

Figure 33. High Voltage Floating Current Source

### KELVIN CONNECTIONS

In many portable instrumentation applications, the PC board area is directly related to cost; therefore, circuit interconnects are reduced to a minimal width. These narrow lines can cause large voltage drops if the voltage reference is required to provide load currents to various functions. In fact, circuit interconnects can exhibit a typical line resistance of 0.45 mΩ/square (1 oz. Cu, for example). Force and sense connections, also referred to as Kelvin connections, offer a convenient method of eliminating the effects of voltage drops in circuit wires. Load currents flowing through wiring resistance produce an error ( $V_{\text{ERROR}} = R \times I_L$ ) at the load. However, the Kelvin connection shown in Figure 34 overcomes the problem by including the wiring resistance within the forcing loop of the op amp. Since the op amp senses the load voltage, the op amp loop control forces the output to compensate for the wiring error producing the correct voltage at the load.

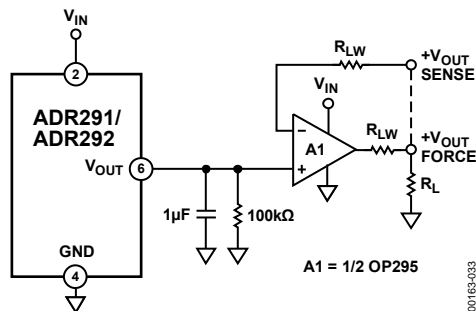

Figure 34. Advantage of Kelvin Connection

### LOW POWER, LOW VOLTAGE REFERENCE FOR DATA CONVERTERS

The ADR291/ADR292 family has a number of features that makes it ideally suited for use with analog-to-digital and digital-to-analog converters. Because of its low supply voltage, the ADR291 can be used with converters that run on 3 V supplies without having to add a higher supply voltage for the reference. The low quiescent current (12 μA maximum) and low noise, tight temperature coefficient, combined with the high accuracy of the ADR291/ADR292, make it ideal for low power applications such as handheld, battery-operated equipment.

One such ADC for which the ADR291 is well suited is the AD7701. Figure 35 shows the ADR291 used as the reference for this converter. The AD7701 is a 16-bit ADC with on-chip digital filtering intended for the measurement of wide dynamic range, low frequency signals such as those representing chemical, physical, or biological processes. It contains a charge balancing ( $\Sigma$ - $\Delta$ ) ADC, calibration microcontroller with on-chip static RAM, a clock oscillator, and a serial communications port.

This entire circuit runs on  $\pm 5$  V supplies. The power dissipation of the AD7701 is typically 25 mW and, when combined with the power dissipation of the ADR291 (60 μW), the entire circuit still consumes about 25 mW.

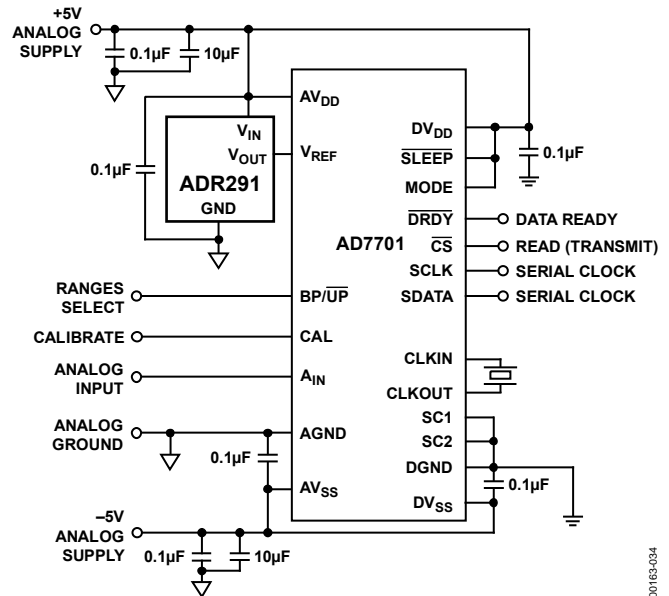

Figure 35. Low Power, Low Voltage Supply Reference for the AD7701

## VOLTAGE REGULATOR FOR PORTABLE EQUIPMENT

The ADR291/ADR292 family of references is ideal for providing a stable, low cost, and low power reference voltage in portable equipment power supplies. Figure 36 shows how the ADR291 and ADR292 can be used in a voltage regulator that not only has low output noise (as compared to switch mode design) and low power, but also a very fast recovery after current surges. Some precautions should be taken in the selection of the output capacitors. Too high an ESR (effective series resistance) could endanger the stability of the circuit. A solid tantalum capacitor, 16 V or higher, and an aluminum electrolytic capacitor, 10 V or higher, are recommended for C1 and C2, respectively. Also, the path from the ground side of C1 and C2 to the ground side of R1 should be kept as short as possible.

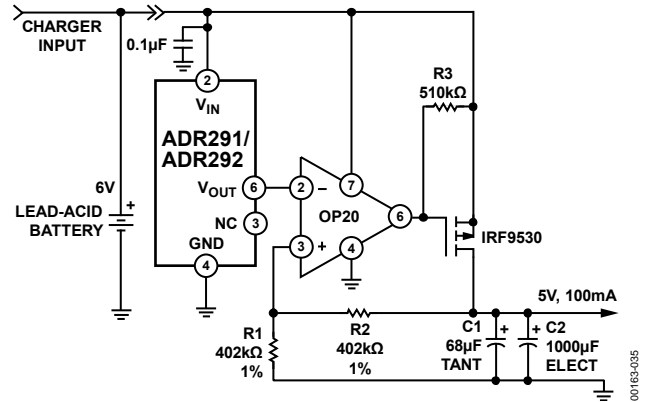
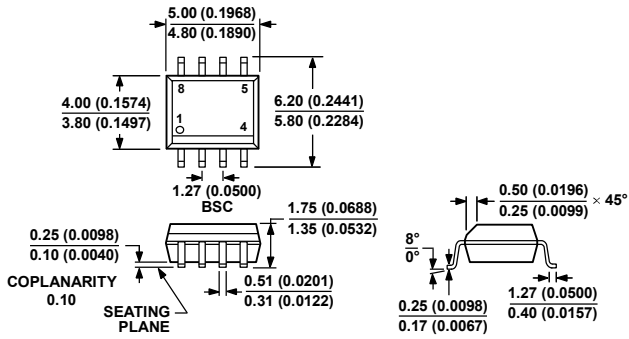

Figure 36. Voltage Regulator for Portable Equipment

## OUTLINE DIMENSIONS



COMPLIANT TO JEDEC STANDARDS MS-012-AA  
 CONTROLLING DIMENSIONS ARE IN MILLIMETERS; INCH DIMENSIONS  
 (IN PARENTHESES) ARE ROUNDED-OFF MILLIMETER EQUIVALENTS FOR  
 REFERENCE ONLY AND ARE NOT APPROPRIATE FOR USE IN DESIGN.

Figure 37. 8-Lead Standard Small Outline Package [SOIC\_N]  
 Narrow Body  
 (R-8)  
 Dimensions shown in millimeters and (inches)

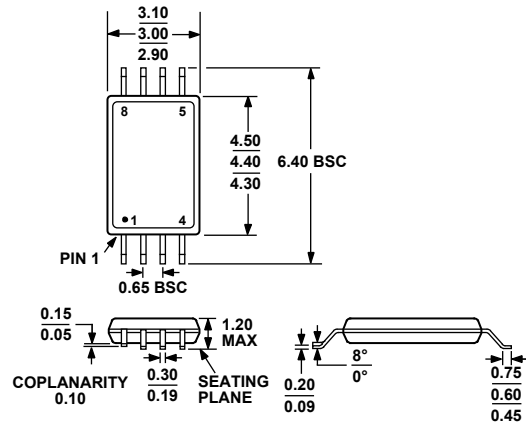

COMPLIANT TO JEDEC STANDARDS MO-153-AA

Figure 38. 8-Lead Thin Shrink Small Outline Package [TSSOP]  
 (RU-8)  
 Dimensions shown in millimeters

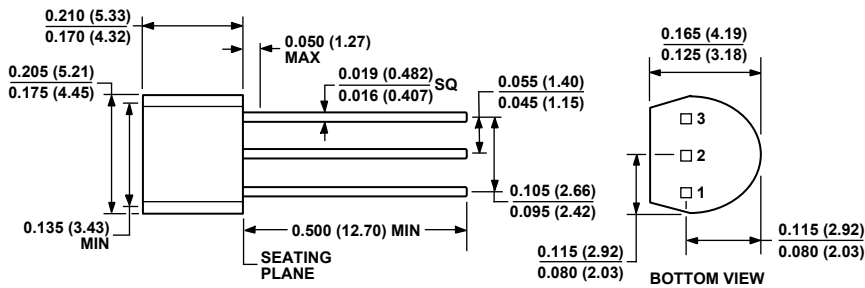

COMPLIANT TO JEDEC STANDARDS TO-226-AA  
 CONTROLLING DIMENSIONS ARE IN INCHES; MILLIMETER DIMENSIONS  
 (IN PARENTHESES) ARE ROUNDED-OFF EQUIVALENTS FOR  
 REFERENCE ONLY AND ARE NOT APPROPRIATE FOR USE IN DESIGN.

Figure 39. 3-Lead Plastic Header-Style Package [TO-92]  
 (T-3)  
 Dimensions shown in inches and (millimeters)



**ORDERING GUIDE**

Model <sup>1</sup>	Output Voltage	Initial Accuracy (±%)	Temperature Coefficient Max (ppm/°C)	Package Description	Package Option	Ordering Quantity
ADR291ERZ	2.50	0.08	8	8-Lead SOIC_N	R-8	98
ADR291ERZ-REEL7	2.50	0.08	8	8-Lead SOIC_N	R-8	1,000
ADR291FRZ	2.50	0.12	15	8-Lead SOIC_N	R-8	98
ADR291FRZ-REEL	2.50	0.12	15	8-Lead SOIC_N	R-8	2,500
ADR291FRZ-REEL7	2.50	0.12	15	8-Lead SOIC_N	R-8	1,000
ADR291GRZ	2.50	0.24	25	8-Lead SOIC_N	R-8	98
ADR291GRZ-REEL	2.50	0.24	25	8-Lead SOIC_N	R-8	2,500
ADR291GRZ-REEL7	2.50	0.24	25	8-Lead SOIC_N	R-8	1,000
ADR291GRUZ	2.50	0.24	25	8-Lead TSSOP	RU-8	98
ADR291GRUZ-REEL	2.50	0.24	25	8-Lead TSSOP	RU-8	1,000
ADR291GRUZ-REEL7	2.50	0.24	25	8-Lead TSSOP	RU-8	1,000
ADR291GT9Z	2.50	0.24	25	3-Lead TO-92	T-3	98
ADR292ERZ	4.096	0.07	8	8-Lead SOIC_N	R-8	98
ADR292ERZ-REEL	4.096	0.07	8	8-Lead SOIC_N	R-8	2,500
ADR292FRZ	4.096	0.10	15	8-Lead SOIC_N	R-8	98
ADR292FRZ-REEL	4.096	0.10	15	8-Lead SOIC_N	R-8	2,500
ADR292FRZ-REEL7	4.096	0.10	15	8-Lead SOIC_N	R-8	1,000
ADR292GRZ	4.096	0.15	25	8-Lead SOIC_N	R-8	98
ADR292GRZ-REEL7	4.096	0.15	25	8-Lead SOIC_N	R-8	1,000
ADR292GRUZ	4.096	0.24	25	8-Lead TSSOP	RU-8	98
ADR292GRUZ-REEL7	4.096	0.15	25	8-Lead TSSOP	RU-8	1,000

<sup>1</sup> Z = RoHS Compliant Part.

**NOTES**

**NOTES**

**NOTES**

# Mouser Electronics

Authorized Distributor

Click to View Pricing, Inventory, Delivery & Lifecycle Information:

[Analog Devices Inc.:](#)

[ADR292GRUZ-REEL7](#) [ADR292FRZ-REEL7](#) [ADR292GRZ-REEL7](#) [ADR292GRUZ](#) [ADR292FRZ](#) [ADR292ERZ-REEL](#)  
[ADR292GRZ](#) [ADR292ERZ](#)