

## MAX16936 Evaluation Kit

Evaluates: MAX16936/MAX16938/  
MAX16939

### General Description

The MAX16936 evaluation kit (EV kit) demonstrates the MAX16936 high-voltage, current-mode step-down converter with low operating current. The EV kit operates over a wide 3.5V to 36V input range and the output is set for 5V at 2.5A.

The EV kit comes with the MAX16936RAUEA/V+ installed.

### Features

- Wide 3.5V to 36V Input Supply Range
- Forced-PWM or Skip-Mode Operation
- Programmable Switching Frequency
- Power-Good Output
- Proven PCB Layout
- Fully Assembled and Tested

[Ordering Information](#) appears at end of data sheet.

**Table 1. EN Configuration (JU1)**

SHUNT POSITION	DESCRIPTION
1-2*	Connects the EN pin to the voltage at SUP for normal operation.
2-3	Connects the EN pin to ground to enter shutdown mode.

\*Default position.

### Quick Start

#### Required Equipment

- MAX16936 EV kit
- 14V, 1A DC power supply
- Electronic load capable of 2.5A
- Digital voltmeter (DVM)

#### Procedure

The EV kit is fully assembled and tested. Follow the steps below to verify board operation. **Caution: Do not turn on supplies until all connections are made.**

- 1) Verify that jumpers JU1 and JU2 are in their default positions, as shown in [Table 1](#) and [Table 2](#).
- 2) Connect the power supply between the EXT\_VBAT and nearest PGND test points.
- 3) Connect the 2.5A electronic load between the OUT and nearest PGND test points.
- 4) Connect the DVM between the OUT and nearest PGND test points.
- 5) Turn on the power supply.
- 6) Enable the electronic load.
- 7) Verify that the voltage at the OUT test point is approximately 5V.

**Table 2. Mode of Operation (JU2)**

SHUNT POSITION	MODE PIN	MODE
1-2*	Connected to BIAS	Forced-PWM mode (device syncs to the internal clock)
2-3	Connected to AGND	SKIP mode
Not installed	Connected to an external clock	Forced-PWM mode (device syncs to an external clock)

\*Default position.

## Detailed Description of Hardware

The EV kit demonstrates the MAX16936 high-voltage, high-frequency, step-down converter with low operating current. The EV kit operates over a wide 3.5V to 36V input range and the output is set for 5V at 2.5A.

### Enable (EN)

Place a shunt in the 1-2 position on jumper JU1 for normal operation. To place the device into shutdown mode, move the shunt on JU1 to the 2-3 position.

### Synchronization Input (FSYNC)

The EV kit features jumper JU2 to control the synchronization input (FSYNC). The device synchronizes to an external signal applied to FSYNC. Connect FSYNC to AGND to enable skip-mode operation. Connect to BIAS or to an external clock to enable fixed-frequency forced-PWM mode operation.

To use an external clock, uninstall the shunt on JU2 and apply the signal at the FSYNC test point. The external clock frequency at FSYNC can be higher or lower than the internal clock by 20%. Ensure that the duty cycle of the external clock used has a minimum 100ns pulse width.

### Synchronizing Output (SYNCOUT)

The EV kit provides jumper JU3 to pull up the open-drain SYNCOUT to the OUT voltage. SYNCOUT is a 180° out-of-phase clock output relative to the internal oscillator at SYNCOUT to create cascaded power supplies with multiple MAX16936s.

## Setting the Switching Frequency (FOSC)

The EV kit switching frequency is set by a resistor,  $R_{FOSC}$  (R2), connected from FOSC to AGND. Refer to Figure 3. in the MAX16936 IC data sheet for a graphical approach of selecting the correct  $R_{FOSC}$  (R2) value.

## Power-Good Output ( $\overline{PGOOD}$ )

The EV kit provides a  $\overline{PGOOD}$  test point to monitor the status of the device output.  $\overline{PGOOD}$  asserts when  $V_{OUT}$  rises above 95% of its regulation voltage.  $\overline{PGOOD}$  deasserts when  $V_{OUT}$  drops below 92% of its regulation voltage.

## Output

Connect FB to BIAS for a fixed +5V (EV kit default output) or a fixed +3.3V output voltage. To set the output to other voltages between 1V and 10V, connect a resistive divider from output (OUT) to FB to AGND. Use the following formula to determine the R4 and R6 of the resistive divider network:

$$R4 = R6 \times \left( \frac{V_{OUT}}{V_{FB}} - 1 \right)$$

where  $V_{FB} = 1V$ .

## Component List

DESIGNATION	QTY	DESCRIPTION
AGND, PGND (x4)	5	Black test points
BIAS, EXT_SUP, EXT_VBAT, FSYNC, PGOOD, OUT, SYNCOUT	7	Red test points
C1	1	47 $\mu$ F $\pm$ 20%, 50V aluminum electrolytic capacitor (8.00mm x 10.20mm) Panasonic EEE-TG1H470UP
C2, C4	2	4.7 $\mu$ F $\pm$ 10%, 50V X7R ceramic capacitors (1210) Murata GCM32ER71H475KA55L
C3, C5	2	0.1 $\mu$ F $\pm$ 10%, 50V X7R ceramic capacitors (0603) Murata GCM188R71H104KA57D
C6	1	0.1 $\mu$ F $\pm$ 10%, 16V X7R ceramic capacitor (0402) Murata GRM155R71C104K
C7, C8	2	22 $\mu$ F $\pm$ 10%, 10V X7R ceramic capacitors (1210) Murata GCM32ER71A226KE12L
C10	1	2.2 $\mu$ F $\pm$ 10%, 10V X7R ceramic capacitor (0603) Murata GRM188R71A225K
C12	1	1000pF $\pm$ 10%, 50V X7R ceramic capacitor (0402) Murata GRM155R71H102K

DESIGNATION	QTY	DESCRIPTION
C13	1	10pF $\pm$ 5%, 50V C0G ceramic capacitor (0402) Murata GRM1555C1H100J
C14, C15	0	Not installed, ceramic capacitors (0402)
D1	1	3A, 60V Schottky diode (SMB) Diodes Inc. B360B-13-F
JU1, JU2	2	3-pin headers
JU3	1	2-pin header
L1	1	2.2 $\mu$ H, 13A inductor (7mm x 6.9mm) Würth 744311220
LX	0	Not installed, red test point
R1	1	20k $\Omega$ $\pm$ 1% resistor (0402)
R2	1	12.1k $\Omega$ $\pm$ 1% resistor (0402)
R3	1	10k $\Omega$ $\pm$ 5% resistor (0402)
R4, R6, R7	0	Not installed, resistors (0402)
R5	1	1k $\Omega$ $\pm$ 5% resistor (0402)
R8	1	0 $\Omega$ $\pm$ 5% resistor (1210)
R9, R10, R12	3	0 $\Omega$ $\pm$ 5% resistors (0402)
R11	1	100k $\Omega$ $\pm$ 5% resistor (0402)
U1	1	Automotive buck converter (16 TSSOP-EP*) Maxim MAX16936SAUEA/V+
—	3	Shunts
—	1	PCB: MAX16936 EVALUATION KIT

\*EP = Exposed pad.

## Component Suppliers

SUPPLIER	PHONE	WEBSITE
Diodes Incorporated	805-446-4800	www.diodes.com
Murata Americas	770-436-1300	www.murataamericas.com
Panasonic Corp.	800-344-2112	www.panasonic.com
Würth Elektronik GmbH & Co. KG	201-785-8800	www.we-online.com

**Note:** Indicate that you are using the MAX16936 when contacting these component suppliers.

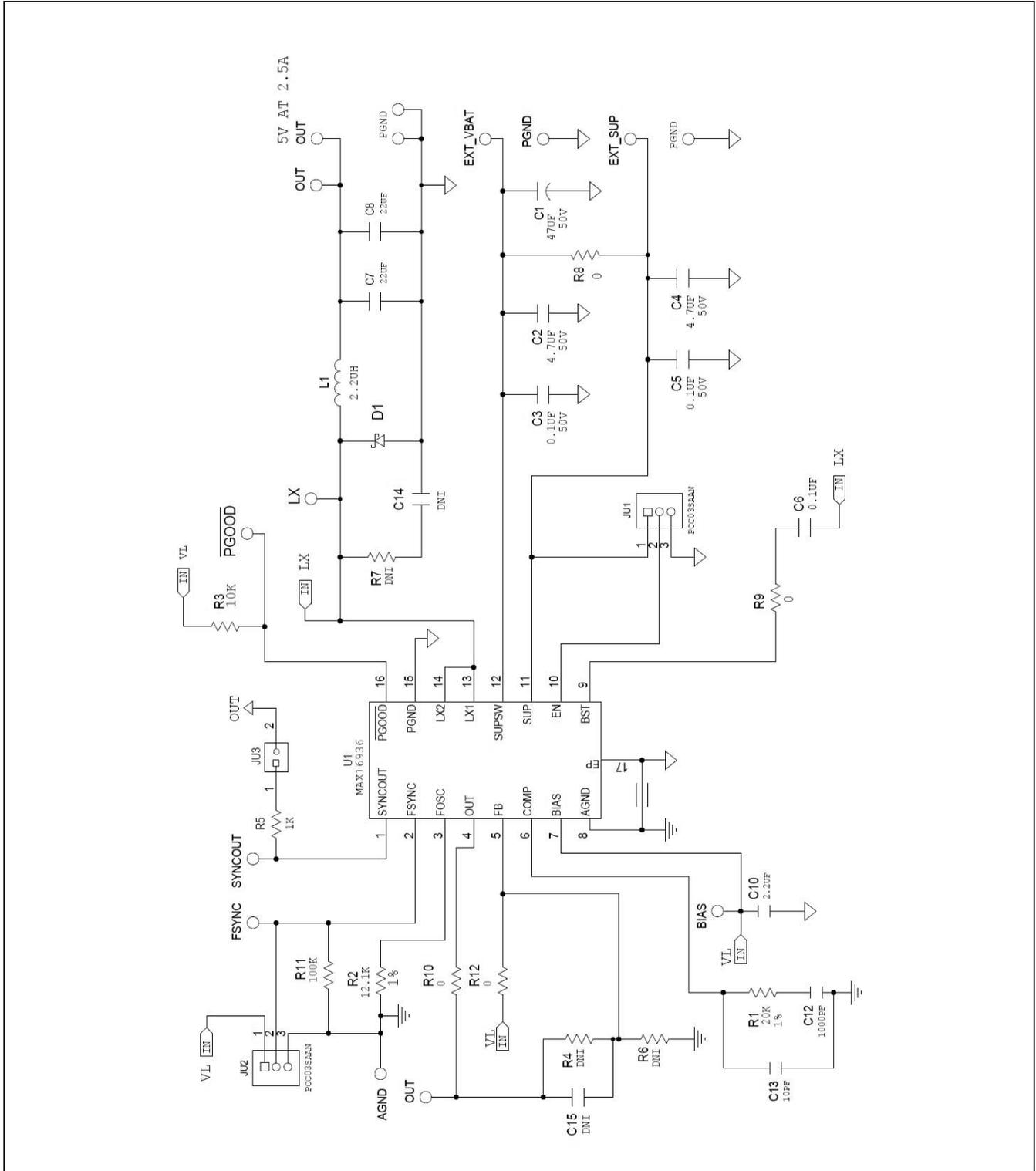

Figure 1. MAX16936 EV Kit Schematic

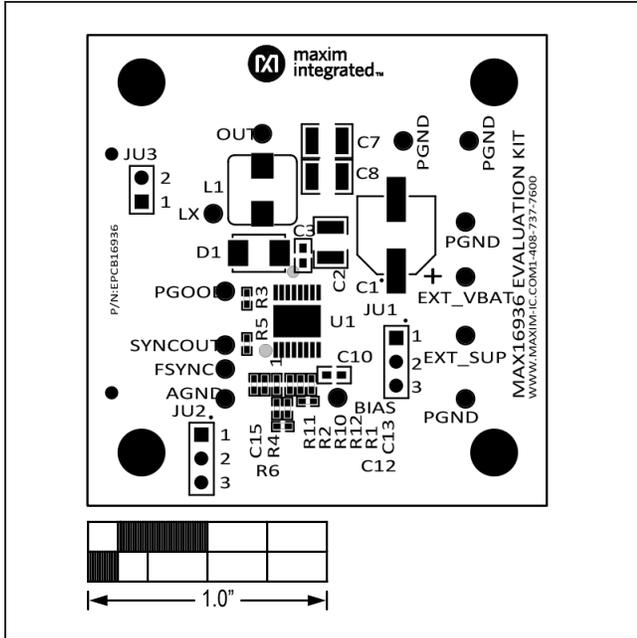

Figure 2. MAX16936 EV Kit Component Placement Guide—Component Side

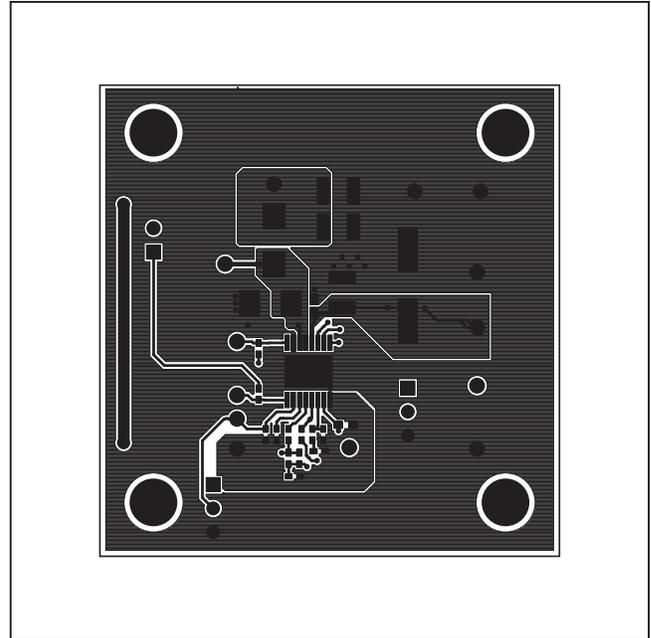

Figure 3. MAX16936 EV Kit PCB Layout—Component Side

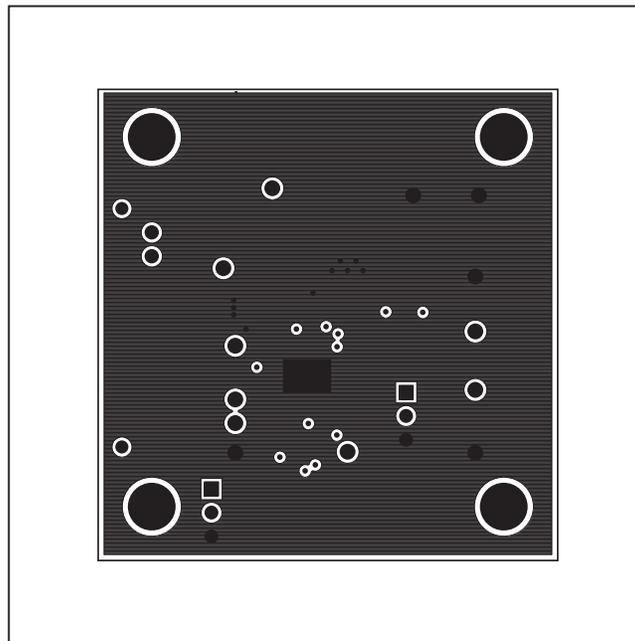

Figure 4. MAX16936 EV Kit PCB Layout—Layer 2

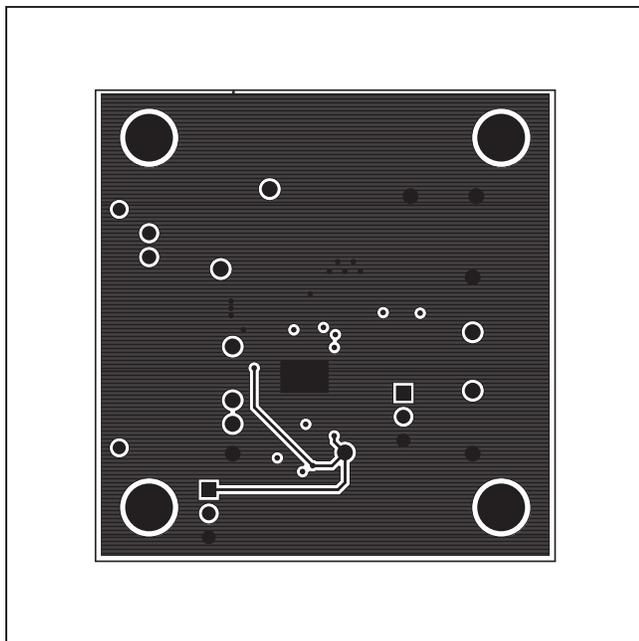

Figure 5. MAX16936 EV Kit PCB Layout—Layer 3

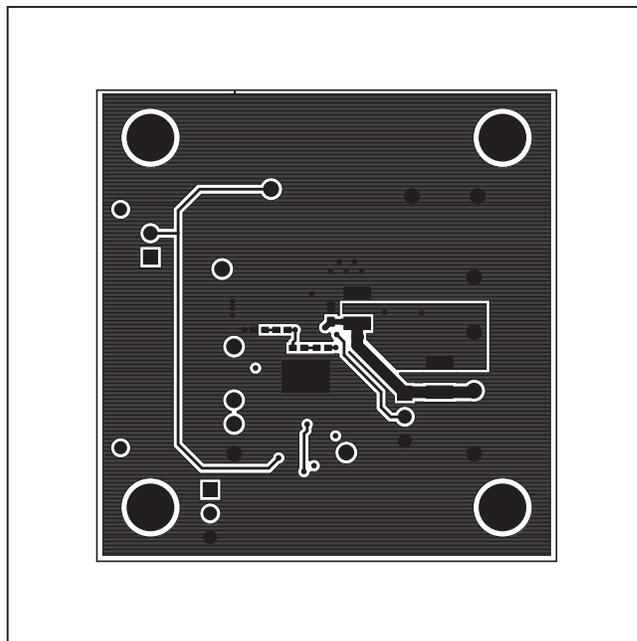

Figure 6. MAX16936 EV Kit PCB Layout—Solder Side

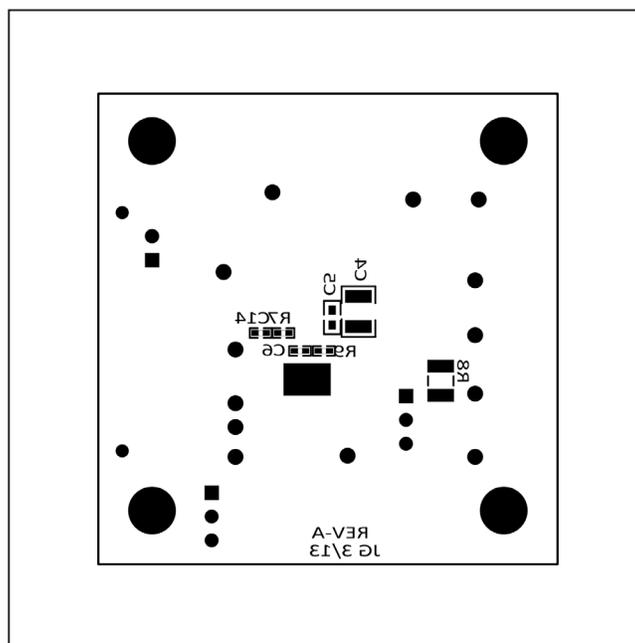

Figure 7. MAX16936 EV Kit Component Placement Guide—  
Solder Side

## Ordering Information

PART	TYPE	PACKAGE
MAX16936EVKIT#	EV Kit	TSSOP
MAX16936REVKIT#	EV Kit	TQFN

#Denotes RoHS compliant.

**Note:** MAX16936EVKIT# can be used for MAX16938 and MAX16939.

## Revision History

REVISION NUMBER	REVISION DATE	DESCRIPTION	PAGES CHANGED
0	8/13	Initial release	—
1	4/16	Added additional ICs that kit can evaluate and updated <i>Ordering Information</i>	1–8
2	3/20	Updated <i>Component List</i> table by replacing with MAX16936SAUEA/V+ in the U1 section	3

For pricing, delivery, and ordering information, please visit Maxim Integrated's online storefront at <https://www.maximintegrated.com/en/storefront/storefront.html>.

Maxim Integrated cannot assume responsibility for use of any circuitry other than circuitry entirely embodied in a Maxim Integrated product. No circuit patent licenses are implied. Maxim Integrated reserves the right to change the circuitry and specifications without notice at any time.

# Mouser Electronics

Authorized Distributor

Click to View Pricing, Inventory, Delivery & Lifecycle Information:

[Maxim Integrated:](#)

[MAX16936EVKIT#](#)