

THIS DRAWING IS UNPUBLISHED. RELEASED FOR PUBLICATION  
 © COPYRIGHT BY TYCO ELECTRONICS CORPORATION. ALL RIGHTS RESERVED.

| LOC | DIST | REVISIONS   |                         |         |       |
|-----|------|-------------|-------------------------|---------|-------|
| P   | LTR  | DESCRIPTION | DATE                    | DWN     | APVD  |
| DW  | -    | E           | REVISED (ECR-13-000755) | 18JAN13 | JL WK |

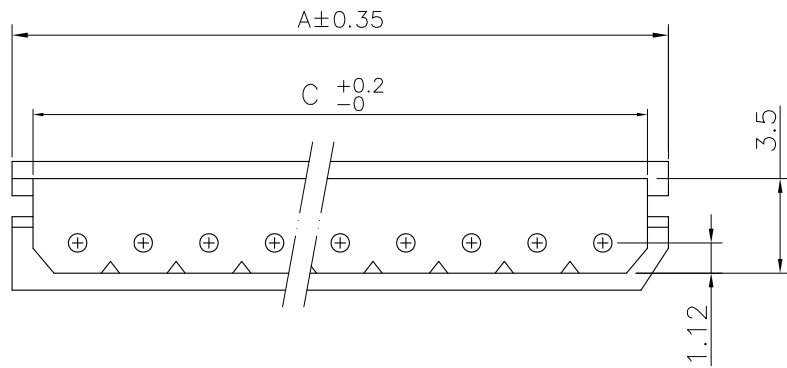
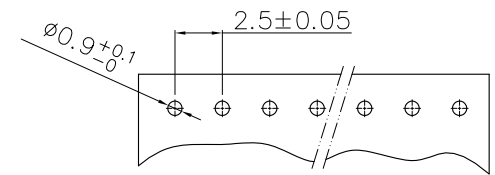
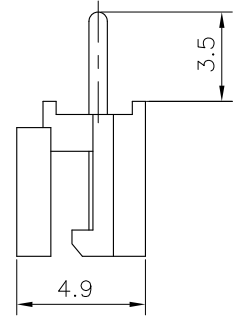
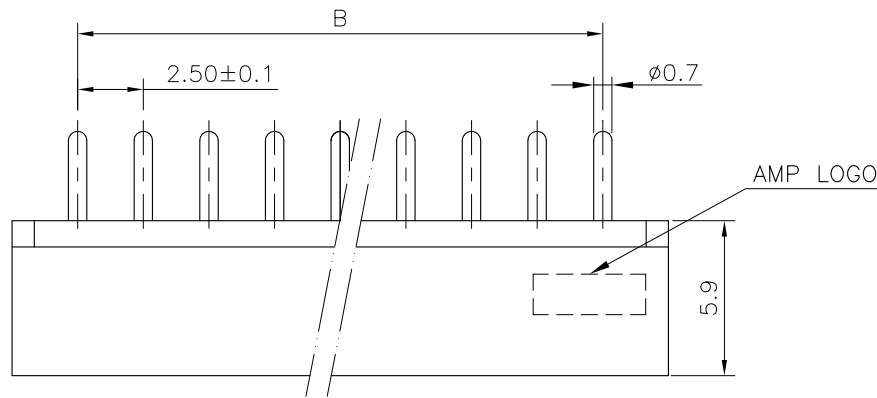

| HSG. COLOR | C    | B           | A    | POS. | PART NUMBER |
|------------|------|-------------|------|------|-------------|
|            |      |             |      |      |             |
|            | 35.9 | 32.50 ±0.20 | 37.5 | 14   | 3-1470224-4 |
|            | 33.4 | 30.00 ±0.20 | 35.0 | 13   | 3-1470224-3 |
|            | 30.9 | 27.50 ±0.20 | 32.5 | 12   | 3-1470224-2 |
|            | 28.4 | 25.00 ±0.20 | 30.0 | 11   | 3-1470224-1 |
|            | 25.9 | 22.50 ±0.15 | 27.5 | 10   | 3-1470224-0 |
|            | 23.4 | 20.00 ±0.15 | 25.0 | 9    | 2-1470224-9 |
|            | 20.9 | 17.50 ±0.15 | 22.5 | 8    | 2-1470224-8 |
|            | 18.4 | 15.00 ±0.15 | 20.0 | 7    | 2-1470224-7 |
|            | 15.9 | 12.50 ±0.10 | 17.5 | 6    | 2-1470224-6 |
|            | 13.4 | 10.00 ±0.10 | 15.0 | 5    | 2-1470224-5 |
|            | 10.9 | 7.50 ±0.10  | 12.5 | 4    | 2-1470224-4 |
|            | 8.4  | 5.00 ±0.10  | 10.0 | 3    | 2-1470224-3 |
|            | 5.9  | 2.50 ±0.10  | 7.5  | 2    | 2-1470224-2 |
|            | 38.4 | 35.00 ±0.20 | 40.0 | 15   | 1-1470224-5 |
|            | 35.9 | 32.50 ±0.20 | 37.5 | 14   | 1-1470224-4 |
|            | 33.4 | 30.00 ±0.20 | 35.0 | 13   | 1-1470224-3 |
|            | 30.9 | 27.50 ±0.20 | 32.5 | 12   | 1-1470224-2 |
|            | 28.4 | 25.00 ±0.20 | 30.0 | 11   | 1-1470224-1 |
|            | 25.9 | 22.50 ±0.15 | 27.5 | 10   | 1-1470224-0 |
|            | 23.4 | 20.00 ±0.15 | 25.0 | 9    | 0-1470224-9 |
|            | 20.9 | 17.50 ±0.15 | 22.5 | 8    | 0-1470224-8 |
|            | 18.4 | 15.00 ±0.15 | 20.0 | 7    | 0-1470224-7 |
|            | 15.9 | 12.50 ±0.10 | 17.5 | 6    | 0-1470224-6 |
|            | 13.4 | 10.00 ±0.10 | 15.0 | 5    | 0-1470224-5 |
|            | 10.9 | 7.50 ±0.10  | 12.5 | 4    | 0-1470224-4 |
|            | 8.4  | 5.00 ±0.10  | 10.0 | 3    | 0-1470224-3 |
|            | 5.9  | 2.50 ±0.10  | 7.5  | 2    | 0-1470224-2 |

- NOTE:
- MATERIAL:  
HOUSING: PA66, UL 94V-2, COLOR: SEE TABLE.  
CONTACTS: BRASS.
  - FINISH:  
CONTACTS: 1.27µm [50µ"] MIN. BRIGHT-TIN ON SOLDER TAIL, WITH ENTIRE CONTACT UNDERPLATED 0.381µm [15µ"] MIN. NICKEL.
  - WAVE SOLDER CAPABLE TO 240°C PER TE CONNECTIVITY TEST SPEC. 109-202, CONDITION A.
- ⚠️ OBSOLETE PARTS: OBSOLETE CIS STREAMLINING PER D.RENAUD/D.SINISI

THIS DRAWING IS A CONTROLLED DOCUMENT.

|                           |                 |                     |   |
|---------------------------|-----------------|---------------------|---|
| DWN O. HU                 | 19DEC2006       | <br>TE Connectivity | 2.5mm PITCH EMIX POST HEADER,<br>VERTICAL TYP |
| CHK S. HOU                | 19DEC2006       |                     |   |
| APVD W.J. KE              | 19DEC2006       |                     |   |
| PRODUCT SPEC              | 108-57175       |                     |   |
| QUALIFICATION TEST REPORT | 501-57195       | NAME                |   |
| MATERIAL SEE NOTE         | FINISH SEE NOTE | SIZE                | A3  |
|                           |                 | CAGE CODE           | 00779   |
|                           |                 | DRAWING NO          | C=1470224                                     |
|                           |                 | RESTRICTED TO       | -   |
| CUSTOMER DRAWING          |                 | SCALE               | -   |
|                           |                 | SHEET               | 1 OF 2  |
|                           |                 | REV                 | E   |

THIS DRAWING IS UNPUBLISHED.

RELEASED FOR PUBLICATION

-. - .

© COPYRIGHT BY TYCO ELECTRONICS CORPORATION. ALL RIGHTS RESERVED.

|     |      |              |     |             |      |     |      |
|-----|------|--------------|-----|-------------|------|-----|------|
| LOC | DIST | REVISIONS    |     |             |      |     |      |
| DW  | -    | P            | LTR | DESCRIPTION | DATE | DWN | APVD |
|     |      | SEE SHEET 1. |     |             |      |     |      |

POLY BAG

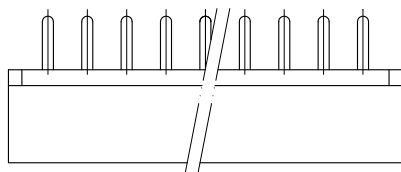
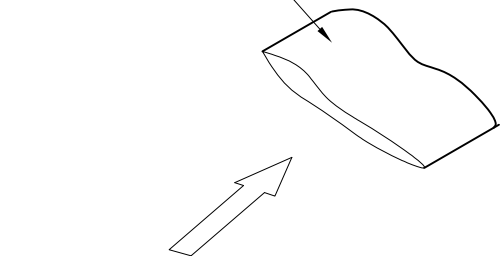

CARTON  
 340mm(L)X470mm(W)X158mm(H)  
 (FOR P/N 0-1470224-2~0-1470224-5)  
 340mm(L)X470mm(W)X316mm(H)  
 (FOR P/N 0-1470224-6~1-1470224-5)

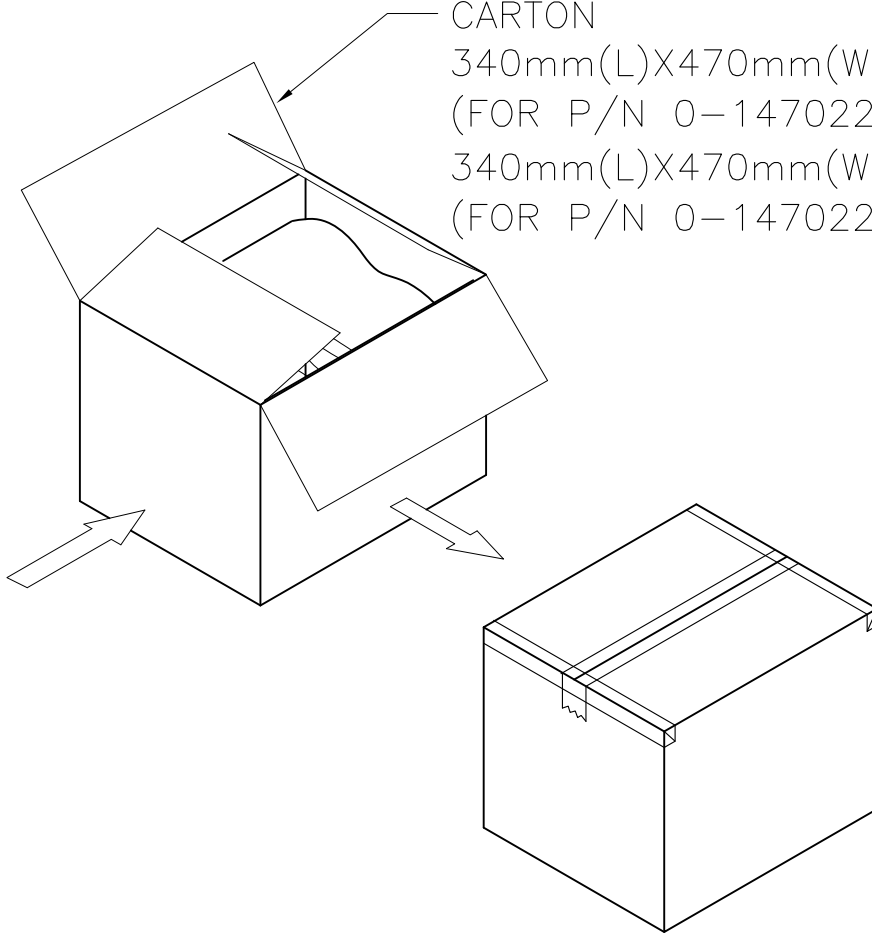

| APQ (PCS/CARTON) | PPQ (PCS/BAG) | PART NUMBER            |             |
|------------------|---------------|------------------------|-------------|
| 12,960           | 180           | <del>3-1470224-5</del> | 1-1470224-5 |
| 12,000           | 200           | <del>3-1470224-4</del> | 1-1470224-4 |
| 14,400           | 200           | <del>3-1470224-3</del> | 1-1470224-3 |
| 16,000           | 250           | <del>3-1470224-2</del> | 1-1470224-2 |
| 16,000           | 250           | <del>3-1470224-1</del> | 1-1470224-1 |
| 20,000           | 250           | <del>3-1470224-0</del> | 1-1470224-0 |
| 21,600           | 300           | 2-1470224-9            | 0-1470224-9 |
| 25,200           | 350           | 2-1470224-8            | 0-1470224-8 |
| 28,000           | 350           | 2-1470224-7            | 0-1470224-7 |
| 35,000           | 350           | 2-1470224-6            | 0-1470224-6 |
| 20,000           | 500           | 2-1470224-5            | 0-1470224-5 |
| 24,000           | 600           | 2-1470224-4            | 0-1470224-4 |
| 30,000           | 750           | 2-1470224-3            | 0-1470224-3 |
| 36,000           | 1000          | 2-1470224-2            | 0-1470224-2 |

THIS DRAWING IS A CONTROLLED DOCUMENT.

DWN O. HU 19DEC2006  
 CHK S. HOU 19DEC2006  
 APVD W.J. KE 19DEC2006

PRODUCT SPEC: -  
 APPLICATION SPEC: -  
 WEIGHT: -

**STE** TE Connectivity

2.5mm PITCH EMIX POST HEADER, VERTICAL TYP

SIZE: A3 CAGE CODE: 00779 C=1470224

CUSTOMER DRAWING SCALE: - SHEET: 2 OF 2 REV: E

# Mouser Electronics

Authorized Distributor

Click to View Pricing, Inventory, Delivery & Lifecycle Information:

[TE Connectivity:](#)

[1470224-4](#)