



# Aluminum electrolytic capacitors

Single-ended capacitors

**Series/Type:** B41866  
**Date:** December 2010

## Long-life grade capacitors for automotive electronics

### Applications

- High-reliability equipment in industrial and automotive electronics
- High-temperature environments

### Features

- High reliability and long useful life
- High ripple current capability
- Wide temperature range up to 125 °C
- RoHS-compatible

### Construction

- Charge-discharge proof, polar
- Aluminum case with insulating sleeve
- Minus pole marking on the insulating sleeve
- Case with safety vent

### Delivery mode

Terminal configurations and packing:

- Bulk
- Taped, Ammo pack
- Cut (see chapter "Single-ended – Taping, packing and lead configurations, Cut leads (Chapter B)")
- Kinked (see chapter "Single-ended – Taping, packing and lead configurations, Kinked leads (Chapter B)")
- PAPR (protection against polarity reversal):  
crimped leads, J leads, bent leads

Refer to chapter "Single-ended capacitors – Taping, packing and lead configurations" for further details.



**Specifications and characteristics in brief**

Rated voltage $V_R$	10 ... 75 V DC							
Surge voltage $V_S$	1.15 · $V_R$ (1.1 · $V_R$ for 75 V DC)							
Rated capacitance $C_R$	10 ... 10000 µF							
Capacitance tolerance	±20% △ M							
Dissipation factor tan δ (20 °C, 120 Hz)	For capacitance higher than 1000 µF add 0.02 for every increase of 1000 µF.							
	$V_R$ (V DC)	10	16 ... 25	35	50	63	75	
	tan δ (max.)	0.20	0.17	0.12	0.10	0.12	0.12	
Leakage current $I_{leak}$ (20 °C, 5 min)	$I_{leak} = 0.01 \mu A \cdot \left( \frac{C_R}{\mu F} \cdot \frac{V_R}{V} \right)$ or 3 µA, whichever is greater							
Self-inductance ESL	Diameter (mm)	8 ... 12.5	16	18				
	ESL (nH)	20	26	34				
Useful life 125 °C; $V_R$ ; $I_{AC,R}$	> 2000 h for $\varnothing = 8$ mm and $V_R \leq 63$ V > 3000 h for $\varnothing = 10$ mm and $V_R \leq 63$ V > 3000 h for $V_R = 75$ V > 5000 h for $\varnothing \geq 12.5$ mm and $V_R \leq 63$ V							
Requirements	$\Delta C/C$	≤ ±35% of initial value						
	tan δ	≤ 3 times initial specified limit						
	$I_{leak}$	≤ initial specified limit						
Voltage endurance test 125 °C; $V_R$	2000 h for $\varnothing = 8$ mm and $V_R \leq 63$ V 3000 h for $\varnothing = 10$ mm and $V_R \leq 63$ V 3000 h for $V_R = 75$ V 5000 h for $\varnothing \geq 12.5$ mm and $V_R \leq 63$ V							
Post test requirements	$\Delta C/C$	≤ ±30% of initial value						
	tan δ	≤ 2 times initial specified limit						
	$I_{leak}$	≤ initial specified limit						
Vibration resistance test	To IEC 60068-2-6, test Fc: Frequency range 10 Hz ... 2 kHz, displacement amplitude max. 1.5 mm, acceleration max. 20 g, duration 3 × 2 h. Capacitor rigidly clamped by the aluminum case.							
IEC climatic category	To IEC 60068-1: 55/125/56 (–55 °C/+125 °C/56 days damp heat test)							
Sectional specification	IEC 60384-4, AEC-Q200							



**B41866**

**High ripple current – 125 °C**

**Dimensional drawings**

**With stand-off rubber seal**

Diameters (mm): 10, 12.5, 16, 18

**With flat rubber seal**

Diameter (mm): 8

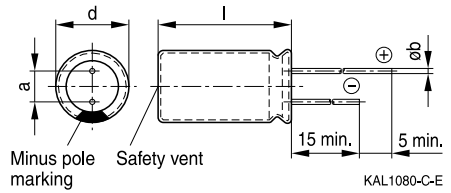
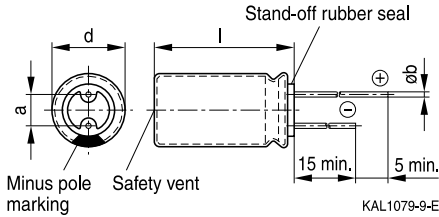

**Dimensions and weights**

Dimensions (mm)				Approx. weight
d +0.5	l	a ±0.5	b	g
8	11.5 +1.5	3.5	0.60 ±0.05	1.0
10	12.5 +1.0	5.0	0.60 ±0.05	1.6
10	16 +1.0	5.0	0.60 ±0.05	1.9
10	20 +2.0	5.0	0.60 ±0.05	2.6
12.5	20 +2.0	5.0	0.60 ±0.05	3.6
12.5	25 +2.0	5.0	0.60 ±0.05	4.5
12.5	40 +2.0	5.0	0.80 ±0.05	7.4
16	20 +2.0	7.5	0.80 ±0.05	5.5
16	25 +2.0	7.5	0.80 ±0.05	7.5
16	31.5 +2.0	7.5	0.80 ±0.05	7.8
16	35.5 +2.0	7.5	0.80 ±0.05	9.2
18	20 +2.0	7.5	0.80 ±0.1	8.0
18	25 +2.0	7.5	0.80 ±0.1	9.0
18	31.5 +2.0	7.5	0.80 ±0.1	11.0
18	35 +2.0	7.5	0.80 ±0.1	13.0
18	40 +2.0	7.5	0.80 ±0.1	16.0

**Overview of available types**

$V_R$ (V DC)	10	16	25	35
	Case dimensions $d \times l$ (mm)			
$C_R$ ( $\mu$ F)				
100		8 × 11.5	8 × 11.5	8 × 11.5
120		8 × 11.5	8 × 11.5	8 × 11.5
150		8 × 11.5	8 × 11.5	10 × 12.5
180		8 × 11.5	8 × 11.5	10 × 12.5
220		8 × 11.5	8 × 11.5	10 × 12.5
270		8 × 11.5	10 × 12.5	10 × 16
330	8 × 11.5	8 × 11.5	10 × 12.5	10 × 16
390	8 × 11.5	10 × 12.5	10 × 16	10 × 20
470	8 × 11.5	10 × 12.5	10 × 16	10 × 20
560	10 × 12.5	10 × 12.5	10 × 20	12.5 × 20
680	10 × 16	10 × 16	10 × 20	12.5 × 20
820	10 × 16	10 × 16	12.5 × 20	12.5 × 25
1000	10 × 16	10 × 20	12.5 × 20	16 × 20
1200	10 × 20	12.5 × 20	12.5 × 25	16 × 25
1500	10 × 20	12.5 × 25	12.5 × 25	16 × 25 18 × 20
1800	12.5 × 20	12.5 × 25	16 × 20	16 × 31.5 18 × 25
2200	12.5 × 20	16 × 20	12.5 × 40 16 × 25 18 × 20	16 × 35.5 18 × 31.5
2700	12.5 × 25	16 × 25 18 × 20	18 × 25	18 × 35
3300	16 × 20	18 × 25	16 × 31.5	18 × 40
3900	16 × 25	18 × 25	16 × 35.5 18 × 31.5	
4700	16 × 25 18 × 20	18 × 31.5	18 × 35	
5600	16 × 31.5	18 × 35	18 × 40	
6800	18 × 31.5	18 × 40		
8200	18 × 31.5			
10000	18 × 40			

**B41866**
**High ripple current – 125 °C**

$V_R$ (V DC)	50	63	75
	Case dimensions $d \times l$ (mm)		
$C_R$ ( $\mu$ F)			
10	8 × 11.5		
12	8 × 11.5		
15	8 × 11.5		
18	8 × 11.5		
22	8 × 11.5		
27	8 × 11.5		
33	8 × 11.5	8 × 11.5	
39	8 × 11.5	10 × 12.5	
47	8 × 11.5	10 × 12.5	
56	8 × 11.5	10 × 12.5	
68	8 × 11.5	10 × 16	
82	8 × 11.5	10 × 16	
100	10 × 12.5	10 × 16	
120	10 × 16	10 × 16	
150	10 × 16	10 × 16	
180	10 × 20	10 × 20	
220	10 × 20	12.5 × 20	
270	10 × 20	12.5 × 20	16 × 20
330	12.5 × 20	12.5 × 20	16 × 25 18 × 20
390	12.5 × 25	12.5 × 25	
470	12.5 × 25 16 × 20	16 × 20	16 × 31.5 18 × 25
560	16 × 20	16 × 20	
680	16 × 25	12.5 × 40 16 × 25 18 × 20	18 × 31.5
820	16 × 25 18 × 20	16 × 31.5	18 × 35
1000	16 × 31.5 18 × 25	16 × 31.5	18 × 40
1200	16 × 35.5 18 × 31.5	18 × 31.5	
1500	18 × 35	18 × 35	
1800	18 × 40	18 × 40	

Other voltage and capacitance ratings are available upon request.

**Technical data and ordering codes**

$C_R$	Case dimensions	$ESR_{max}$ 10 kHz −40 °C	$ESR_{max}$ 10 kHz 20 °C	$Z_{max}$ 100 kHz 20 °C	$I_{AC,R}$ 100 kHz 125 °C	Ordering code (composition see below)
120 Hz 20 °C μF	d × l mm	Ω	Ω	Ω	mA	
<b><math>V_R = 10</math> V DC</b>						
330	8 × 11.5	5.170	0.646	0.573	297	B41866C3337M***
390	8 × 11.5	5.170	0.646	0.573	297	B41866C3397M***
470	8 × 11.5	5.170	0.646	0.573	297	B41866C3477M***
560	10 × 12.5	2.980	0.373	0.336	450	B41866C3567M***
680	10 × 16	1.404	0.175	0.160	714	B41866C3687M***
820	10 × 16	1.404	0.175	0.160	714	B41866C3827M***
1000	10 × 16	1.404	0.175	0.160	714	B41866C3108M***
1200	10 × 20	1.070	0.134	0.127	875	B41866C3128M***
1500	10 × 20	1.070	0.134	0.127	875	B41866C3158M***
1800	12.5 × 20	0.881	0.110	0.104	1105	B41866C3188M***
2200	12.5 × 20	0.881	0.110	0.104	1105	B41866C3228M***
2700	12.5 × 25	0.710	0.089	0.082	1358	B41866C3278M***
3300	16 × 20	0.401	0.050	0.046	1895	B41866C3338M***
3900	16 × 25	0.314	0.039	0.037	2279	B41866C3398M***
4700	16 × 25	0.314	0.039	0.037	2279	B41866C3478M***
4700	18 × 20	0.341	0.043	0.040	2190	B41866D3478M***
5600	16 × 31.5	0.249	0.031	0.029	2822	B41866C3568M***
6800	18 × 31.5	0.226	0.028	0.027	3178	B41866C3688M***
8200	18 × 31.5	0.226	0.028	0.027	3178	B41866C3828M***
10000	18 × 40	0.153	0.019	0.018	4244	B41866C3109M***

**Composition of ordering code**

\*\*\* = Version

000 = for standard leads, bulk

001 = for kinked leads, bulk (for d × l = 10 × 20 ... 12.5 × 25 mm and Ø 16 ... 18 mm)

002 = for cut leads, bulk (for Ø 10 ... 18 mm, excluding d × l = 12.5 × 40 mm)

003 = for crimped leads, blister (for Ø 16 ... 18 mm)

004 = for J leads, blister (for Ø 10 ... 18 mm, excluding d × l = 12.5 × 40 and 18 × 40 mm)

006 = for taped leads, Ammo pack, lead spacing F = 3.5 mm (for Ø 8 mm)

008 = for taped leads, Ammo pack, lead spacing F = 5.0 mm (for d × l = 8 × 11.5 ... 12.5 × 25 mm)

009 = for taped leads, Ammo pack, lead spacing F = 7.5 mm (for d × l = 16 × 20 ... 16 × 31.5 mm and 18 × 20 ... 18 × 31.5 mm)

012 = for bent 90° leads, blister (for Ø 16 ... 18 mm)

**B41866**
**High ripple current – 125 °C**
**Technical data and ordering codes**

$C_R$	Case dimensions	$ESR_{max}$ 10 kHz –40 °C	$ESR_{max}$ 10 kHz 20 °C	$Z_{max}$ 100 kHz 20 °C	$I_{AC,R}$ 100 kHz 125 °C	Ordering code (composition see below)
$\mu F$	d × l mm	$\Omega$	$\Omega$	$\Omega$	mA	
<b><math>V_R = 16 V DC</math></b>						
100	8 × 11.5	5.170	0.646	0.573	297	B41866C4107M***
120	8 × 11.5	5.170	0.646	0.573	297	B41866C4127M***
150	8 × 11.5	5.170	0.646	0.573	297	B41866C4157M***
180	8 × 11.5	5.170	0.646	0.573	297	B41866C4187M***
220	8 × 11.5	5.170	0.646	0.573	297	B41866C4227M***
270	8 × 11.5	5.170	0.646	0.573	297	B41866C4277M***
330	8 × 11.5	5.170	0.646	0.573	297	B41866C4337M***
390	10 × 12.5	2.980	0.373	0.336	450	B41866C4397M***
470	10 × 12.5	2.980	0.373	0.336	450	B41866C4477M***
560	10 × 12.5	2.980	0.373	0.336	450	B41866C4567M***
680	10 × 16	1.404	0.175	0.160	714	B41866C4687M***
820	10 × 16	1.404	0.175	0.160	714	B41866C4827M***
1000	10 × 20	1.070	0.134	0.127	875	B41866C4108M***
1200	12.5 × 20	0.881	0.110	0.104	1105	B41866C4128M***
1500	12.5 × 25	0.710	0.089	0.082	1358	B41866C4158M***
1800	12.5 × 25	0.710	0.089	0.082	1358	B41866C4188M***
2200	16 × 20	0.401	0.050	0.046	1895	B41866C4228M***
2700	16 × 25	0.314	0.039	0.037	2279	B41866C4278M***
2700	18 × 20	0.341	0.043	0.040	2190	B41866D4278M***
3300	18 × 25	0.314	0.039	0.037	2454	B41866C4338M***
3900	18 × 25	0.314	0.039	0.037	2454	B41866C4398M***
4700	18 × 31.5	0.226	0.028	0.027	3178	B41866C4478M***
5600	18 × 35	0.187	0.023	0.022	3638	B41866C4568M***
6800	18 × 40	0.153	0.019	0.018	4244	B41866C4688M***

**Composition of ordering code**

\*\*\* = Version

000 = for standard leads, bulk

 001 = for kinked leads, bulk (for d × l = 10 × 20 ... 12.5 × 25 mm and  $\varnothing$  16 ... 18 mm)

 002 = for cut leads, bulk (for  $\varnothing$  10 ... 18 mm, excluding d × l = 12.5 × 40 mm)

 003 = for crimped leads, blister (for  $\varnothing$  16 ... 18 mm)

 004 = for J leads, blister (for  $\varnothing$  10 ... 18 mm, excluding d × l = 12.5 × 40 and 18 × 40 mm)

 006 = for taped leads, Ammo pack, lead spacing F = 3.5 mm (for  $\varnothing$  8 mm)

008 = for taped leads, Ammo pack, lead spacing F = 5.0 mm (for d × l = 8 × 11.5 ... 12.5 × 25 mm)

009 = for taped leads, Ammo pack, lead spacing F = 7.5 mm (for d × l = 16 × 20 ... 16 × 31.5 mm and 18 × 20 ... 18 × 31.5 mm)

 012 = for bent 90° leads, blister (for  $\varnothing$  16 ... 18 mm)



**Technical data and ordering codes**

$C_R$	Case dimensions	$ESR_{max}$	$ESR_{max}$	$Z_{max}$	$I_{AC,R}$	Ordering code (composition see below)
120 Hz	$d \times l$	10 kHz	10 kHz	100 kHz	100 kHz	
20 °C	mm	-40 °C	20 °C	20 °C	125 °C	
$\mu F$		$\Omega$	$\Omega$	$\Omega$	mA	
<b><math>V_R = 25 V DC</math></b>						
100	8 × 11.5	5.170	0.646	0.573	297	B41866C5107M***
120	8 × 11.5	5.170	0.646	0.573	297	B41866C5127M***
150	8 × 11.5	5.170	0.646	0.573	297	B41866C5157M***
180	8 × 11.5	5.170	0.646	0.573	297	B41866C5187M***
220	8 × 11.5	5.170	0.646	0.573	297	B41866C5227M***
270	10 × 12.5	2.980	0.373	0.336	450	B41866C5277M***
330	10 × 12.5	2.980	0.373	0.336	450	B41866C5337M***
390	10 × 16	1.404	0.175	0.160	714	B41866C5397M***
470	10 × 16	1.404	0.175	0.160	714	B41866C5477M***
560	10 × 20	1.070	0.134	0.127	875	B41866C5567M***
680	10 × 20	1.070	0.134	0.127	875	B41866C5687M***
820	12.5 × 20	0.881	0.110	0.104	1105	B41866C5827M***
1000	12.5 × 20	0.881	0.110	0.104	1105	B41866C5108M***
1200	12.5 × 25	0.710	0.089	0.082	1358	B41866C5128M***
1500	12.5 × 25	0.710	0.089	0.082	1358	B41866C5158M***
1800	16 × 20	0.401	0.050	0.046	1895	B41866C5188M***
2200	12.5 × 40	0.406	0.051	0.047	2185	B41866C5228M***
2200	16 × 25	0.314	0.039	0.037	2279	B41866D5228M***
2200	18 × 20	0.341	0.043	0.040	2190	B41866E5228M***
2700	18 × 25	0.312	0.039	0.037	2454	B41866D5278M***
3300	16 × 31.5	0.248	0.031	0.029	2822	B41866D5338M***
3900	16 × 35.5	0.200	0.025	0.024	3230	B41866E5398M***
3900	18 × 31.5	0.224	0.028	0.027	3178	B41866D5398M***
4700	18 × 35	0.184	0.023	0.022	3638	B41866D5478M***
5600	18 × 40	0.152	0.019	0.018	4244	B41866C5568M***

**Composition of ordering code**

\*\*\* = Version

- 000 = for standard leads, bulk
- 001 = for kinked leads, bulk (for  $d \times l = 10 \times 20 \dots 12.5 \times 25$  mm and  $\varnothing 16 \dots 18$  mm)
- 002 = for cut leads, bulk (for  $\varnothing 10 \dots 18$  mm, excluding  $d \times l = 12.5 \times 40$  mm)
- 003 = for crimped leads, blister (for  $\varnothing 16 \dots 18$  mm)
- 004 = for J leads, blister (for  $\varnothing 10 \dots 18$  mm, excluding  $d \times l = 12.5 \times 40$  and  $18 \times 40$  mm)
- 006 = for taped leads, Ammo pack, lead spacing  $F = 3.5$  mm (for  $\varnothing 8$  mm)
- 008 = for taped leads, Ammo pack, lead spacing  $F = 5.0$  mm (for  $d \times l = 8 \times 11.5 \dots 12.5 \times 25$  mm)
- 009 = for taped leads, Ammo pack, lead spacing  $F = 7.5$  mm (for  $d \times l = 16 \times 20 \dots 16 \times 31.5$  mm and  $18 \times 20 \dots 18 \times 31.5$  mm)
- 012 = for bent 90° leads, blister (for  $\varnothing 16 \dots 18$  mm)

**B41866**
**High ripple current – 125 °C**
**Technical data and ordering codes**

$C_R$	Case dimensions	$ESR_{max}$ 10 kHz -40 °C	$ESR_{max}$ 10 kHz 20 °C	$Z_{max}$ 100 kHz 20 °C	$I_{AC,R}$ 100 kHz 125 °C	Ordering code (composition see below)
$\mu F$	$d \times l$ mm	$\Omega$	$\Omega$	$\Omega$	mA	
<b><math>V_R = 35 V DC</math></b>						
100	8 × 11.5	5.170	0.646	0.573	297	B41866C7107M***
120	8 × 11.5	5.170	0.646	0.573	297	B41866C7127M***
150	10 × 12.5	2.980	0.373	0.336	450	B41866C7157M***
180	10 × 12.5	2.980	0.373	0.336	450	B41866C7187M***
220	10 × 12.5	2.980	0.373	0.336	450	B41866C7227M***
270	10 × 16	1.404	0.175	0.160	714	B41866C7277M***
330	10 × 16	1.404	0.175	0.160	714	B41866C7337M***
390	10 × 20	1.070	0.134	0.127	875	B41866C7397M***
470	10 × 20	1.070	0.134	0.127	875	B41866C7477M***
560	12.5 × 20	0.881	0.110	0.104	1105	B41866C7567M***
680	12.5 × 20	0.881	0.110	0.104	1105	B41866C7687M***
820	12.5 × 25	0.710	0.089	0.082	1358	B41866C7827M***
1000	16 × 20	0.401	0.050	0.046	1895	B41866C7108M***
1200	16 × 25	0.314	0.039	0.037	2279	B41866C7128M***
1500	16 × 25	0.314	0.039	0.037	2279	B41866C7158M***
1500	18 × 20	0.341	0.043	0.040	2190	B41866D7158M***
1800	16 × 31.5	0.249	0.031	0.029	2822	B41866C7188M***
1800	18 × 25	0.314	0.039	0.037	2454	B41866D7188M***
2200	16 × 35.5	0.200	0.025	0.024	3230	B41866D7228M***
2200	18 × 31.5	0.226	0.028	0.027	3178	B41866C7228M***
2700	18 × 35	0.187	0.023	0.022	3638	B41866C7278M***
3300	18 × 40	0.153	0.019	0.018	4244	B41866C7338M***
<b><math>V_R = 50 V DC</math></b>						
10	8 × 11.5	7.445	0.931	0.826	160	B41866C6106M***
12	8 × 11.5	7.445	0.931	0.826	160	B41866C6126M***
15	8 × 11.5	7.445	0.931	0.826	160	B41866C6156M***
18	8 × 11.5	7.445	0.931	0.826	160	B41866C6186M***

**Composition of ordering code**

\*\*\* = Version

- 000 = for standard leads, bulk
- 001 = for kinked leads, bulk (for  $d \times l = 10 \times 20 \dots 12.5 \times 25$  mm and  $\varnothing 16 \dots 18$  mm)
- 002 = for cut leads, bulk (for  $\varnothing 10 \dots 18$  mm, excluding  $d \times l = 12.5 \times 40$  mm)
- 003 = for crimped leads, blister (for  $\varnothing 16 \dots 18$  mm)
- 004 = for J leads, blister (for  $\varnothing 10 \dots 18$  mm, excluding  $d \times l = 12.5 \times 40$  and  $18 \times 40$  mm)
- 006 = for taped leads, Ammo pack, lead spacing  $F = 3.5$  mm (for  $\varnothing 8$  mm)
- 008 = for taped leads, Ammo pack, lead spacing  $F = 5.0$  mm (for  $d \times l = 8 \times 11.5 \dots 12.5 \times 25$  mm)
- 009 = for taped leads, Ammo pack, lead spacing  $F = 7.5$  mm (for  $d \times l = 16 \times 20 \dots 16 \times 31.5$  mm and  $18 \times 20 \dots 18 \times 31.5$  mm)
- 012 = for bent 90° leads, blister (for  $\varnothing 16 \dots 18$  mm)

**Technical data and ordering codes**

$C_R$	Case dimensions	$ESR_{max}$ 10 kHz -40 °C	$ESR_{max}$ 10 kHz 20 °C	$Z_{max}$ 100 kHz 20 °C	$I_{AC,R}$ 100 kHz 125 °C	Ordering code (composition see below)
$\mu F$	d × l mm	$\Omega$	$\Omega$	$\Omega$	mA	
<b><math>V_R = 50 V DC</math></b>						
22	8 × 11.5	7.445	0.931	0.826	210	B41866C6226M***
27	8 × 11.5	7.445	0.931	0.826	210	B41866C6276M***
33	8 × 11.5	6.204	0.776	0.688	250	B41866C6336M***
39	8 × 11.5	6.204	0.776	0.688	250	B41866C6396M***
47	8 × 11.5	5.687	0.711	0.631	370	B41866C6476M***
56	8 × 11.5	5.429	0.679	0.602	370	B41866C6566M***
68	8 × 11.5	5.170	0.646	0.573	370	B41866C6686M***
82	8 × 11.5	5.170	0.646	0.573	370	B41866C6826M***
100	10 × 12.5	2.980	0.373	0.336	450	B41866C6107M***
120	10 × 16	1.404	0.175	0.160	714	B41866C6127M***
150	10 × 16	1.404	0.175	0.160	714	B41866C6157M***
180	10 × 20	1.070	0.134	0.127	875	B41866C6187M***
220	10 × 20	1.070	0.134	0.127	875	B41866C6227M***
270	10 × 20	1.070	0.134	0.127	875	B41866C6277M***
330	12.5 × 20	0.881	0.110	0.104	1105	B41866C6337M***
390	12.5 × 25	0.710	0.089	0.082	1358	B41866C6397M***
470	12.5 × 25	0.710	0.089	0.082	1358	B41866C6477M***
470	16 × 20	0.680	0.085	0.080	1370	B41866D6477M***
560	16 × 20	0.401	0.050	0.046	1895	B41866C6567M***
680	16 × 25	0.314	0.039	0.037	2279	B41866C6687M***
820	16 × 25	0.314	0.039	0.037	2279	B41866C6827M***
820	18 × 20	0.344	0.043	0.040	2190	B41866E6827M***
1000	16 × 31.5	0.249	0.031	0.029	2822	B41866C6108M***
1000	18 × 25	0.314	0.039	0.037	2454	B41866D6108M***
1200	16 × 35.5	0.200	0.025	0.024	3230	B41866D6128M***
1200	18 × 31.5	0.226	0.028	0.027	3178	B41866C6128M***
1500	18 × 35	0.187	0.023	0.022	3638	B41866C6158M***
1800	18 × 40	0.153	0.019	0.018	4244	B41866C6188M***

**Composition of ordering code**

\*\*\* = Version

000 = for standard leads, bulk

 001 = for kinked leads, bulk (for d × l = 10 × 20 ... 12.5 × 25 mm and  $\varnothing$  16 ... 18 mm)

 002 = for cut leads, bulk (for  $\varnothing$  10 ... 18 mm, excluding d × l = 12.5 × 40 mm)

 003 = for crimped leads, blister (for  $\varnothing$  16 ... 18 mm)

 004 = for J leads, blister (for  $\varnothing$  10 ... 18 mm, excluding d × l = 12.5 × 40 and 18 × 40 mm)

 006 = for taped leads, Ammo pack, lead spacing F = 3.5 mm (for  $\varnothing$  8 mm)

008 = for taped leads, Ammo pack, lead spacing F = 5.0 mm (for d × l = 8 × 11.5 ... 12.5 × 25 mm)

009 = for taped leads, Ammo pack, lead spacing F = 7.5 mm (for d × l = 16 × 20 ... 16 × 31.5 mm and 18 × 20 ... 18 × 31.5 mm)

 012 = for bent 90° leads, blister (for  $\varnothing$  16 ... 18 mm)

**B41866**
**High ripple current – 125 °C**
**Technical data and ordering codes**

$C_R$	Case dimensions	$ESR_{max}$ 10 kHz –40 °C	$ESR_{max}$ 10 kHz 20 °C	$Z_{max}$ 100 kHz 20 °C	$I_{AC,R}$ 100 kHz 125 °C	Ordering code (composition see below)
$\mu F$	d × l mm	$\Omega$	$\Omega$	$\Omega$	mA	
<b><math>V_R = 63 V DC</math></b>						
33	8 × 11.5	13.776	1.722	1.62	153	B41866C8336M***
39	10 × 12.5	4.456	0.557	0.533	309	B41866C8396M***
47	10 × 12.5	4.456	0.557	0.533	309	B41866C8476M***
56	10 × 12.5	4.456	0.557	0.533	309	B41866C8566M***
68	10 × 16	2.856	0.357	0.326	433	B41866C8686M***
82	10 × 16	2.856	0.357	0.326	433	B41866C8826M***
100	10 × 16	2.856	0.357	0.326	433	B41866C8107M***
120	10 × 16	2.856	0.357	0.326	433	B41866C8127M***
150	10 × 16	2.856	0.357	0.326	433	B41866C8157M***
180	10 × 20	1.920	0.240	0.244	546	B41866C8187M***
220	12.5 × 20	1.408	0.176	0.182	723	B41866C8227M***
270	12.5 × 20	1.408	0.176	0.182	723	B41866C8277M***
330	12.5 × 20	1.408	0.176	0.182	723	B41866C8337M***
390	12.5 × 25	0.936	0.117	0.116	989	B41866C8397M***
470	16 × 20	1.624	0.203	0.191	930	B41866C8477M***
560	16 × 20	1.624	0.203	0.191	930	B41866C8567M***
680	12.5 × 40	0.528	0.066	0.067	1588	B41866C8687M***
680	16 × 25	1.216	0.152	0.143	1165	B41866D8687M***
680	18 × 20	1.480	0.185	0.173	1052	B41866E8687M***
820	16 × 31.5	0.976	0.122	0.109	1461	B41866C8827M***
1000	16 × 31.5	0.976	0.122	0.109	1461	B41866C8108M***
1200	18 × 31.5	0.976	0.122	0.099	1645	B41866C8128M***
1500	18 × 35	0.752	0.094	0.085	1847	B41866C8158M***
1800	18 × 40	0.672	0.084	0.080	2015	B41866C8188M***

**Composition of ordering code**

\*\*\* = Version

000 = for standard leads, bulk

 001 = for kinked leads, bulk (for d × l = 10 × 20 ... 12.5 × 25 mm and  $\varnothing$  16 ... 18 mm)

 002 = for cut leads, bulk (for  $\varnothing$  10 ... 18 mm, excluding d × l = 12.5 × 40 mm)

 003 = for crimped leads, blister (for  $\varnothing$  16 ... 18 mm)

 004 = for J leads, blister (for  $\varnothing$  10 ... 18 mm, excluding d × l = 12.5 × 40 and 18 × 40 mm)

 006 = for taped leads, Ammo pack, lead spacing F = 3.5 mm (for  $\varnothing$  8 mm)

008 = for taped leads, Ammo pack, lead spacing F = 5.0 mm (for d × l = 8 × 11.5 ... 12.5 × 25 mm)

009 = for taped leads, Ammo pack, lead spacing F = 7.5 mm (for d × l = 16 × 20 ... 16 × 31.5 mm and 18 × 20 ... 18 × 31.5 mm)

 012 = for bent 90° leads, blister (for  $\varnothing$  16 ... 18 mm)



**Technical data and ordering codes**

$C_R$	Case dimensions	$ESR_{max}$	$ESR_{max}$	$Z_{max}$	$I_{AC,R}$	Ordering code (composition see below)
120 Hz	$d \times l$	10 kHz	10 kHz	100 kHz	100 kHz	
20 °C	mm	-40 °C	20 °C	20 °C	125 °C	
$\mu F$		$\Omega$	$\Omega$	$\Omega$	mA	
<b><math>V_R = 75 V DC</math></b>						
270	16 × 20	1.572	0.131	0.128	930	B41866C0277M***
330	16 × 25	1.260	0.105	0.103	1165	B41866C0337M***
330	18 × 20	1.488	0.124	0.121	1052	B41866D0337M***
470	16 × 31.5	0.900	0.075	0.073	1461	B41866C0477M***
470	18 × 25	1.044	0.087	0.085	1178	B41866D0477M***
680	18 × 31.5	0.768	0.064	0.062	1645	B41866C0687M***
820	18 × 35	0.672	0.056	0.054	1847	B41866C0827M***
1000	18 × 40	0.576	0.048	0.047	2015	B41866C0108M***

**Composition of ordering code**

\*\*\* = Version

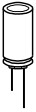
- 000 = for standard leads, bulk
- 001 = for kinked leads, bulk (for  $d \times l = 10 \times 20 \dots 12.5 \times 25$  mm and  $\varnothing 16 \dots 18$  mm)
- 002 = for cut leads, bulk (for  $\varnothing 10 \dots 18$  mm, excluding  $d \times l = 12.5 \times 40$  mm)
- 003 = for crimped leads, blister (for  $\varnothing 16 \dots 18$  mm)
- 004 = for J leads, blister (for  $\varnothing 10 \dots 18$  mm, excluding  $d \times l = 12.5 \times 40$  and  $18 \times 40$  mm)
- 006 = for taped leads, Ammo pack, lead spacing  $F = 3.5$  mm (for  $\varnothing 8$  mm)
- 008 = for taped leads, Ammo pack, lead spacing  $F = 5.0$  mm (for  $d \times l = 8 \times 11.5 \dots 12.5 \times 25$  mm)
- 009 = for taped leads, Ammo pack, lead spacing  $F = 7.5$  mm (for  $d \times l = 16 \times 20 \dots 16 \times 31.5$  mm and  $18 \times 20 \dots 18 \times 31.5$  mm)
- 012 = for bent 90° leads, blister (for  $\varnothing 16 \dots 18$  mm)



**B41866**

**High ripple current – 125 °C**

**Useful life**

depending on ambient temperature  $T_A$  under ripple current operating conditions<sup>1)</sup>

$d = 8 \text{ mm}$  and  $V_R \leq 63 V_{DC}$

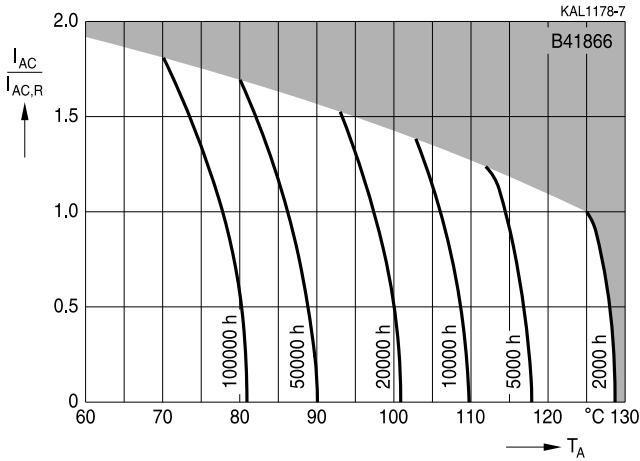

**Useful life**

depending on ambient temperature  $T_A$  under ripple current operating conditions<sup>1)</sup>

$d = 10 \text{ mm}$  and  $V_R \leq 63 V_{DC}$

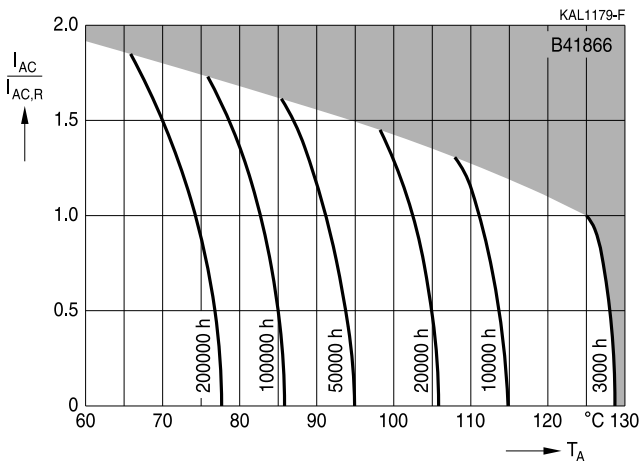

1) Refer to chapter "General technical information, 5.3 Calculation of useful life" for an explanation on how to interpret the useful life graphs.



**Useful life**

depending on ambient temperature  $T_A$  under ripple current operating conditions<sup>2)</sup>

$d \geq 12.5 \text{ mm}$  and  $V_R \leq 63 \text{ V}_{DC}$

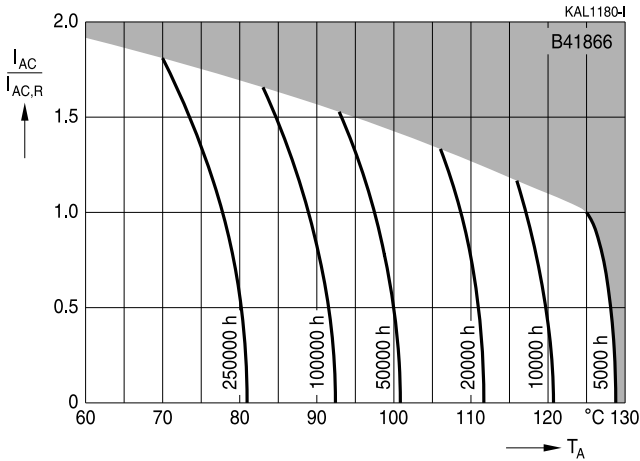

**Useful life**

depending on ambient temperature  $T_A$  under ripple current operating conditions<sup>2)</sup>

$V_R = 75 \text{ V}_{DC}$

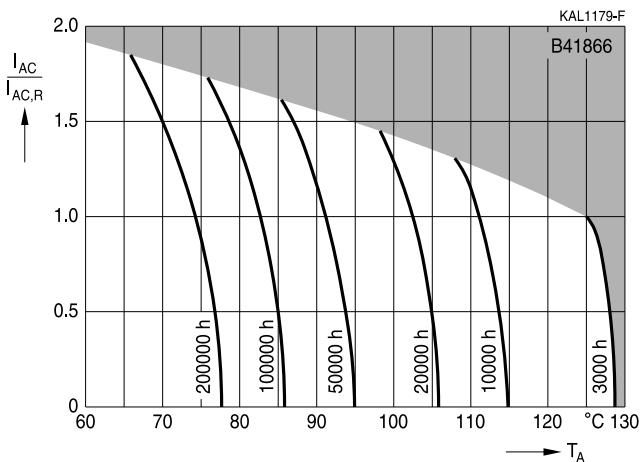

2) Refer to chapter "General technical information, 5.3 Calculation of useful life" for an explanation on how to interpret the useful life graphs.



**B41866**

**High ripple current – 125 °C**

**Frequency factor of permissible ripple current  $I_{AC}$  versus frequency  $f$**

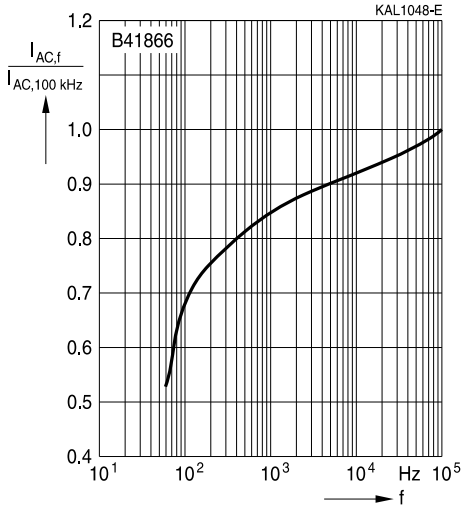





## Taping, packing and lead configurations

### Taping

Single-ended capacitors are available taped in Ammo pack from diameter 4 to 18 mm as follows:

Lead spacing  $F = 2.0$  mm ( $\varnothing d = 4 \dots 5$  mm)

Lead spacing  $F = 2.5$  mm ( $\varnothing d = 4 \dots 6.3$  mm)

Lead spacing  $F = 3.5$  mm ( $\varnothing d = 8$  mm)

Lead spacing  $F = 5.0$  mm ( $\varnothing d = 4 \dots 12.5$  mm)

Lead spacing  $F = 7.5$  mm ( $\varnothing d = 16 \dots 18$  mm).

### Lead spacing 2.0 mm ( $\varnothing d = 4 \dots 5$ mm)

Last 3 digits of ordering code: 016

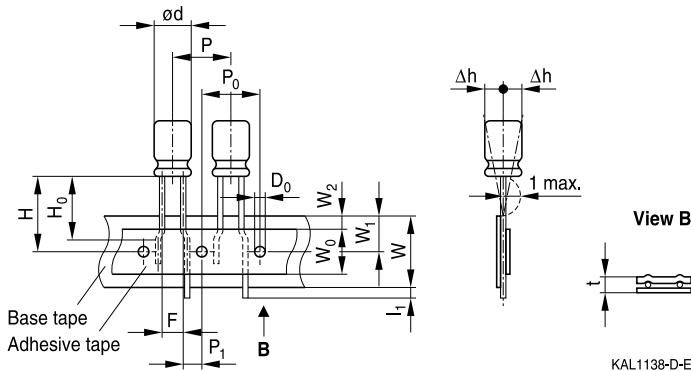

KAL1138-D-E

### Dimensions in mm

$\varnothing d$	F	H	W	$W_0$	$W_1$	$W_2$	P	$P_0$	$P_1$	$l_1$	t	$\Delta h$	$D_0$
4 ... 5	2.0	18.5	18.0	7.0	9.0	3.0	12.7	12.7	5.10	1.0	0.7	1	4.0
	+0.8 -0.2	±0.75	±0.5	min.	±0.5	max.	±1.0	±0.3	±0.7	max.	±0.2	±1.0	±0.2

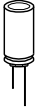

**B41866**

**High ripple current – 125 °C**

**Lead spacing 2.5 mm (∅ d = 4 ... 6.3 mm)**

Last 3 digits of ordering code: 007

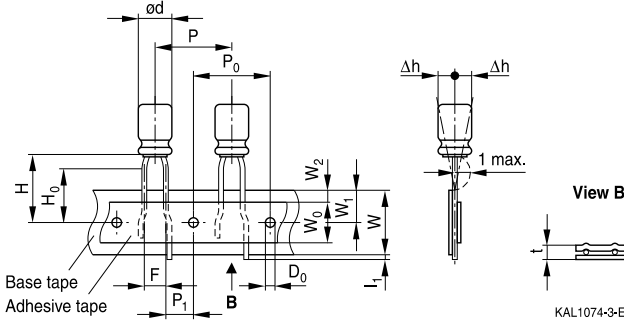

**Dimensions in mm**

∅ d	F	H	W	W <sub>0</sub>	W <sub>1</sub>	W <sub>2</sub>	H <sub>0</sub>	P	P <sub>0</sub>	P <sub>1</sub>	l <sub>1</sub>	t	Δh	D <sub>0</sub>
4 ... 6.3	2.5	18.5	18.0	5.5	9.0	1.5	16.0	12.7	12.7	5.1	1.0	0.7	1.0	4.0
Tolerance	+0.8 -0.2	±0.75	±0.5	min.	±0.5	max.	±0.5	±1.0	±0.2	±0.5	max.	±0.2	max.	±0.2

**Lead spacing 3.5 mm (∅ d = 8 mm)**

Last 3 digits of ordering code: 006

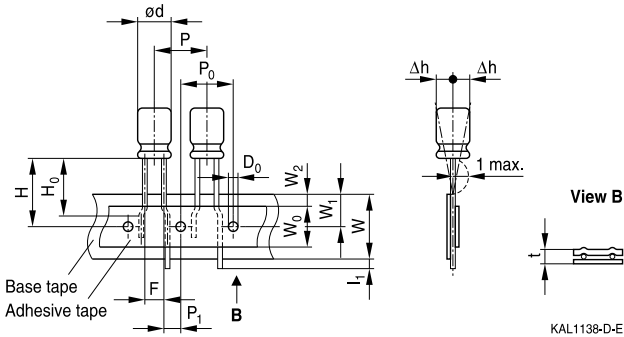

**Dimensions in mm**

∅ d	F	H	W	W <sub>0</sub>	W <sub>1</sub>	W <sub>2</sub>	P	P <sub>0</sub>	P <sub>1</sub>	l <sub>1</sub>	t	Δh	D <sub>0</sub>
8	3.5	18.5	18.0	10	9.0	3.0	12.7	12.7	4.6	1.0	0.7	1.0	4.0
Tolerance	+0.8 -0.2	±1.0	±0.5	min.	±0.5	max.	±1.0	±0.3	±0.6	max.	±0.2	max.	±0.2

Leads can also run straight through the taping area. Taping is available up to dimensions  $d \times l = 8 \times 15$  mm.

**Lead spacing 5.0 mm (∅ d = 4 ... 8 mm)**

Last 3 digits of ordering code: 008

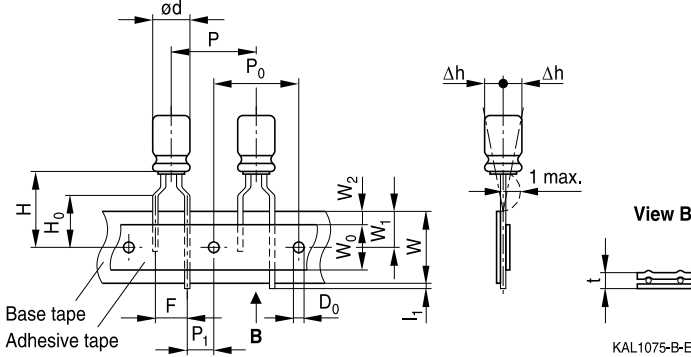
**Lead spacing 5.0 mm (∅ d = 10 ... 12.5 mm)**

Last 3 digits of ordering code: 008

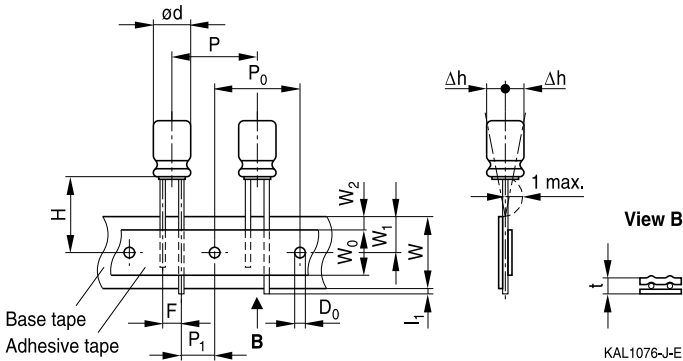
**Dimensions in mm**

∅ d	F	H	W	W <sub>0</sub>	W <sub>1</sub>	W <sub>2</sub>	H <sub>0</sub>	P	P <sub>0</sub>	P <sub>1</sub>	l <sub>1</sub>	t	Δh	D <sub>0</sub>
4 ... 6.3	5.0	18.5	18.0	5.5	9.0	1.5	16.0	12.7	12.7	3.85	1.0	0.6	1.0	4.0
8	5.0	20.0	18.0	10.0	9.0	1.5	16.0	12.7	12.7	3.85	1.0	0.6	1.0	4.0
		19.0		12.5			12.7	3.85						
10	5.0	19.0	18.0	12.5	9.0	1.5	—	12.7	12.7	3.85	1.0	0.6	1.0	4.0
12.5	5.0	19.0	18.0	12.5	9.0	1.5	—	15.0	15.0	5.0	1.0	0.6	1.0	4.0
Tolerance	+0.8 -0.2	±0.75	±0.5	min.	±0.5	max.	±0.5	±1.0	±0.2	±0.5	max.	+0.3 -0.2	max.	±0.2

Taping is available up to dimensions d × l = 10 × 31.5 mm and 12.5 × 25 mm.

Taping is not available for d × l = 8 × 20 mm.



**B41866**

**High ripple current – 125 °C**

**Lead spacing 7.5 mm (∅ d = 16 ...18 mm)**

Last 3 digits of ordering code: 009

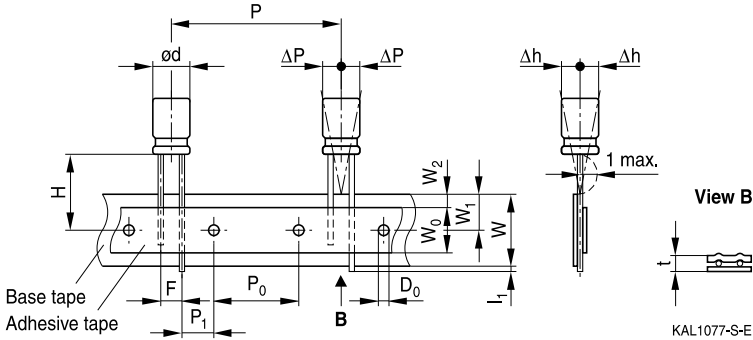

**Dimensions in mm**

∅ d	F	H	W	W <sub>0</sub>	W <sub>1</sub>	W <sub>2</sub>	P	P <sub>0</sub>	P <sub>1</sub>	I <sub>1</sub>	t	ΔP	Δh	D <sub>0</sub>
16	7.5	18.5	18.0	12.5	9.0	1.5	30.0	15.0	3.75	1.0	0.7	0	0	4.0
18														
Tolerance	±0.8	-0.5 +0.75	±0.5	min.	±0.5	max.	±1.0	±0.2	±0.5	max.	±0.2	±1.0	±1.0	±0.2

Taping is available up to dimensions d × l = 16 × 31.5 mm and 18 × 31.5 mm.



### Cut or kinked leads

Single-ended capacitors are available with cut or kinked leads. Other lead configurations also available upon request.

### Cut leads (Chapter A)

Available for series B41002, B41022, B41044, B41827, B41828, B43044, B43082, B43086, B43088, B43827, B43828.

Last 3 digits of ordering code: 002

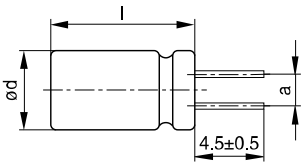

KAL1086-R

Case size d x l (mm)	Dimensions (mm) a ±0.5
4 x 7	1.5
5 x 7	2.0
5 x 11	2.0
6.3 x 7	2.5
6.3 x 11	2.5
8 x 7	3.5
8 x 11.5	3.5
8 x 15	3.5
8 x 20	3.5
10 x 12.5	5.0
10 x 16	5.0
10 x 20	5.0
10 x 25	5.0
10 x 31.5	5.0

Case size d x l (mm)	Dimensions (mm) a ±0.5
12.5 x 16	5.0
12.5 x 20	5.0
12.5 x 25	5.0
12.5 x 31.5	5.0
12.5 x 35.5	5.0
12.5 x 40	5.0
16 x 20	7.5
16 x 25	7.5
16 x 31.5	7.5
16 x 35.5	7.5
16 x 40	7.5
18 x 20	7.5
18 x 25	7.5
18 x 31.5	7.5
18 x 35.5	7.5
18 x 40	7.5



**B41866**

**High ripple current – 125 °C**

**Cut leads (Chapter B)**

Available for series B41858, B41859, B41863, B41866, B41868, B41888, B41890, B41896, B42824, B42851, B43866, B43867, B43890, B43896.

Last 3 digits of ordering code: 002

**With stand-off rubber seal**

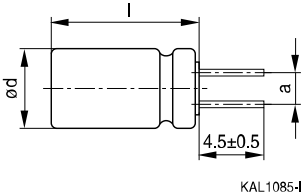

**With flat rubber seal**

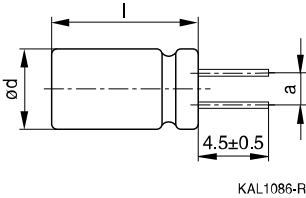

Case size d × l (mm)	Dimensions (mm) a ±0.5
10 × 12.5	5.0
10 × 16	5.0
10 × 20	5.0
12.5 × 20	5.0
12.5 × 25	5.0
16 × 20	7.5
16 × 25	7.5
16 × 31.5	7.5
16 × 35.5	7.5
18 × 20	7.5
18 × 25	7.5
18 × 31.5	7.5
18 × 35	7.5
18 × 40	7.5



**Kinked leads (Chapter A)**

Available for series B41002, B41022, B41044, B41827, B41828, B43044, B43082, B43086, B43088, B43827, B43828.

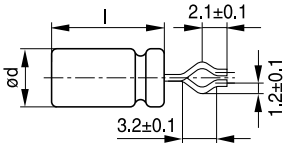
Last 3 digits of ordering code: 001

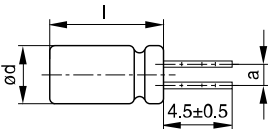

KAL1137-5



KAL1084-A

Case size d x l (mm)	Dimensions (mm) a ±0.5
4 x 7	1.5
5 x 7	2.0
5 x 11	2.0
6.3 x 7	2.5
6.3 x 11	2.5
8 x 7	3.5
8 x 11.5	3.5
8 x 15	3.5
8 x 20	3.5
10 x 12.5	5.0
10 x 16	5.0
10 x 20	5.0
10 x 25	5.0
10 x 31.5	5.0

Case size d x l (mm)	Dimensions (mm) a ±0.5
12.5 x 16	5.0
12.5 x 20	5.0
12.5 x 25	5.0
12.5 x 31.5	5.0
12.5 x 35.5	5.0
12.5 x 40	5.0
16 x 20	7.5
16 x 25	7.5
16 x 31.5	7.5
16 x 35.5	7.5
16 x 40	7.5
18 x 20	7.5
18 x 25	7.5
18 x 31.5	7.5
18 x 35.5	7.5
18 x 40	7.5



**B41866**

**High ripple current – 125 °C**

**Kinked leads (Chapter B)**

Available for series B41858, B41859, B41863, B41866, B41868, B41888, B41890, B41896, B42824, B42851, B43866, B43867, B43890, B43896.

Last 3 digits of ordering code: 001

**With stand-off rubber seal**

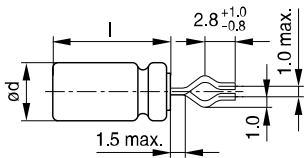

KAL1081-K

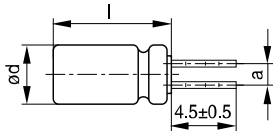

KAL1083-2

**With flat rubber seal**

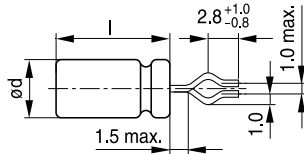

KAL1082-T

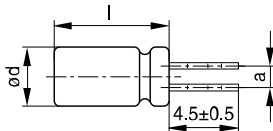

KAL1084-A

Case size $d \times l$ (mm)	Dimensions (mm) $a \pm 0.5$
10 × 20	5.0
12.5 × 20	5.0
12.5 × 25	5.0
16 × 20	7.5
16 × 25	7.5
16 × 31.5	7.5
16 × 35.5	7.5
18 × 20	7.5
18 × 25	7.5
18 × 31.5	7.5
18 × 35	7.5
18 × 40	7.5





### PAPR leads (Protection Against Polarity Reversal)

These lead configurations ensure correct placement of the capacitor on the PCB with regard to polarity. PAPR leads are available for diameters from 10 mm up to 18 mm.

There are three configurations available: Crimped leads, J leads, bent 90° leads

Available for series B41858, B41859, B41863, B41866, B41868, B41888, B41890, B41896, B42824, B42851, B43866, B43867, B43890, B43896.

### Crimped leads

Last 3 digits of ordering code: 003

#### With stand-off rubber seal

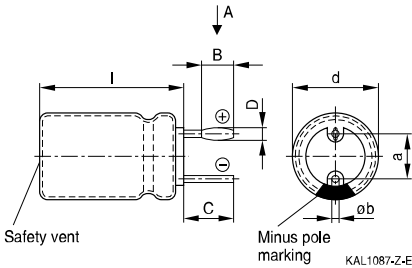

#### With flat rubber seal

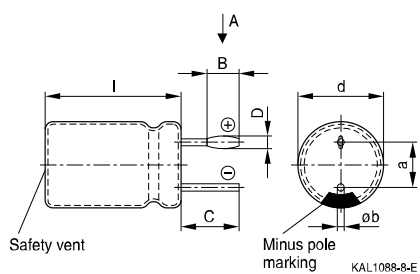

### Suggestion for PCB hole diameter

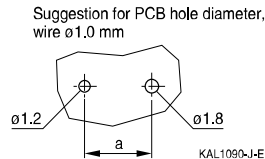
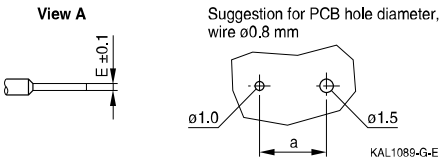

Case size d × l (mm)	Dimensions (mm)					
	B ±0.2	C ±0.5	D ±0.1	E ±0.1	a ±0.5	Øb
16 × 20	1.5	3.0	1.3	0.3	7.5	0.8 ±0.05
16 × 25	1.5	3.0	1.3	0.3	7.5	0.8 ±0.05
16 × 31.5	1.5	3.0	1.3	0.3	7.5	0.8 ±0.05
16 × 35.5	1.5	3.0	1.3	0.3	7.5	0.8 ±0.05
18 × 20	1.5	3.0	1.3	0.3	7.5	0.8 ±0.1
18 × 25	1.5	3.0	1.3	0.3	7.5	0.8 ±0.1
18 × 31.5	1.5	3.0	1.3	0.3	7.5	0.8 ±0.1
18 × 35	1.5	3.0	1.3	0.3	7.5	0.8 ±0.1
18 × 40	1.5	3.0	1.3	0.3	7.5	0.8 ±0.1

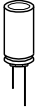

**B41866**

**High ripple current – 125 °C**

**J leads**

Last 3 digits of ordering code: 004

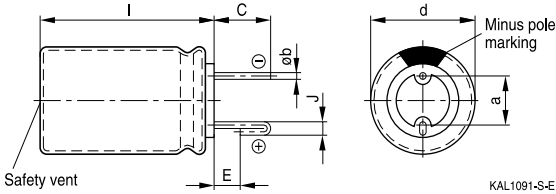

**Suggestion for PCB hole diameter**

Suggestion for PCB hole diameter, wire  $\varnothing 0.6$  mm

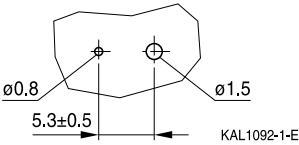

Suggestion for PCB hole diameter, wire  $\varnothing 0.8$  mm

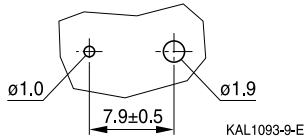

Case size d × l (mm)	Dimensions (mm)				
	C ±0.5	E ±0.5	J ±0.2	a ±0.5	∅b
10 × 12.5	3.2	0.7	1.2	5.0	0.6 ±0.05
10 × 16	3.2	0.7	1.2	5.0	0.6 ±0.05
10 × 20	3.2	0.7	1.2	5.0	0.6 ±0.05
12.5 × 20	3.2	0.7	1.2	5.0	0.6 ±0.05
12.5 × 25	3.2	0.7	1.2	5.0	0.6 ±0.05
16 × 20	3.5	0.7	1.6	7.5	0.8 ±0.05
16 × 25	3.5	0.7	1.6	7.5	0.8 ±0.05
16 × 31.5	3.5	0.7	1.6	7.5	0.8 ±0.05
16 × 35.5	3.5	0.7	1.6	7.5	0.8 ±0.05
18 × 20	3.5	0.7	1.6	7.5	0.8 ±0.1
18 × 25	3.5	0.7	1.6	7.5	0.8 ±0.1
18 × 31.5	3.5	0.7	1.6	7.5	0.8 ±0.1
18 × 35	3.5	0.7	1.6	7.5	0.8 ±0.1

**Bent 90° leads for horizontal mounting pinning**

Last 3 digits of ordering code: 012

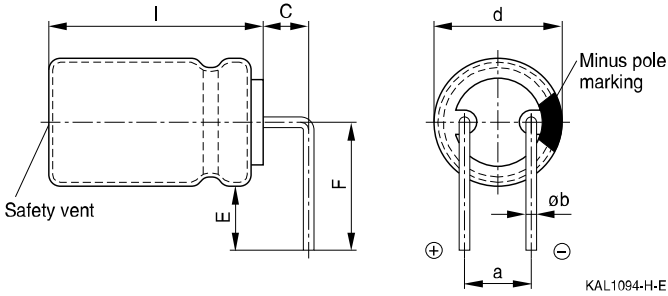

Case size d × l (mm)	Dimensions (mm)				
	C ±0.5	E ±0.5	F ±0.5	a ±0.5	Øb
16 × 20	4.0	4.0	12.0	7.5	0.8 ±0.05
16 × 25	4.0	4.0	12.0	7.5	0.8 ±0.05
16 × 31.5	4.0	4.0	12.0	7.5	0.8 ±0.05
16 × 35.5	4.0	4.0	12.0	7.5	0.8 ±0.05
18 × 20	4.0	4.0	13.0	7.5	0.8 ±0.1
18 × 25	4.0	4.0	13.0	7.5	0.8 ±0.1
18 × 31.5	4.0	4.0	13.0	7.5	0.8 ±0.1
18 × 35	4.0	4.0	13.0	7.5	0.8 ±0.1
18 × 40	4.0	4.0	13.0	7.5	0.8 ±0.1

Bent leads for diameter 12.5 mm available upon request.

**B41866**
**High ripple current – 125 °C**
**Packing units and box dimensions**
**Ammo pack**

Valid for series B41002, B41022, B41044, B41827, B41828, B43044, B43082, B43086, B43088, B43827, B43828.

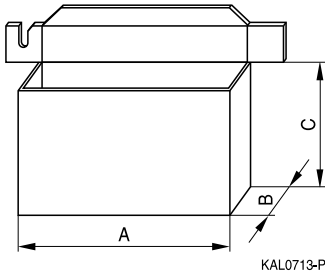

Case size d × l mm	Dimensions (mm)			Packing units pcs.
	A <sub>max</sub>	B <sub>max</sub>	C <sub>max</sub>	
4 × 7	330	50	196	2000
5 × 7	330	50	226	2000
5 × 11	330	50	226	2000
6.3 × 7	330	50	286	2000
6.3 × 11	330	50	286	2000
8 × 7	330	50	246	1000
8 × 11.5	330	50	246	1000
8 × 15	330	50	246	500
10 × 12.5	330	50	196	500
10 × 16	330	54	196	500
10 × 20	330	58	196	500
12.5 × 20	341	60	272	500
12.5 × 25	341	65	272	500
16 × 25	320	65	270	300
16 × 31.5	315	65	275	300
18 × 20	315	65	275	250
18 × 25	315	65	275	250
18 × 31.5	315	65	275	250



### Ammo pack

Valid for series B41858, B41859, B41863, B41866, B41868, B41888, B41890, B41896, B42824, B42851, B43866, B43867, B43890, B43896.

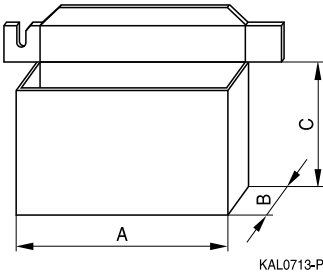

Case size d × l mm	Dimensions (mm)			Packing units pcs.
	A <sub>max</sub>	B <sub>max</sub>	C <sub>max</sub>	
8 × 11.5	345	55	240	1000
10 × 12.5	345	55	280	750
10 × 16	345	60	200	500
10 × 20	345	60	200	500
12.5 × 20	345	65	280	500
12.5 × 25	345	65	280	500
16 × 20	315	65	275	300
16 × 25	315	65	275	300
16 × 31.5	315	65	275	300
18 × 20	315	65	275	250
18 × 25	315	65	275	250
18 × 31.5	315	65	275	250

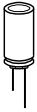

**B41866**

**High ripple current – 125 °C**

**Overview of packing units and code numbers for case sizes 4 x 7 ... 16 x 40**

Valid for series B41002, B41022, B41044, B41827, B41828, B43044, B43082, B43086, B43088, B43827, B43828.

Case size d x l mm	Standard, bulk pcs.	Taped, Ammo pack pcs.	Kinked leads, bulk pcs.	Cut leads, bulk pcs.		
4 x 7	10000	2000	15000	15000		
5 x 7	7500	2000	10000	10000		
5 x 11	5000	2000	10000	10000		
6.3 x 7	5000	2000	10000	10000		
6.3 x 11	5000	2000	5000	5000		
8 x 7	5000	1000	5000	5000		
8 x 11.5	2500	1000	4000	4000		
8 x 15	2000	1000	2500	2500		
8 x 20	1500	–	2000	2000		
10 x 12.5	2000	500	2500	2500		
10 x 16	1500	500	2000	2000		
10 x 20	1000	500	1500	1500		
10 x 25	1000	500	1250	1250		
12.5 x 16	750	500	1000	1000		
12.5 x 20	750	500	500	500		
12.5 x 25	750	500	500	500		
12.5 x 31.5	500	–	750	750		
12.5 x 35.5	500	–	750	750		
12.5 x 40	500	–	750	750		
16 x 20	375	300	500	500		
16 x 25	375	300	500	500		
16 x 31.5	250	300	375	375		
16 x 35.5	250	–	375	375		
16 x 40	250	–	375	375		
The last three digits of the complete ordering code state the lead configuration	<b>000</b>	Code	F (mm)	d (mm)	<b>001</b>	<b>002</b>
		006	3.5	8		
		007	2.5	4 ... 6.3		
		008	5.0	4 ... 12.5		
		009	7.5	16 ... 18		
		016	2.0	4 ... 5		

**Overview of packing units and code numbers for case sizes 18 x 20 ... 18 x 40**

Valid for series B41002, B41022, B41044, B41827, B41828, B43044, B43082, B43086, B43088, B43827, B43828.

Case size d x l mm	Standard, bulk pcs.	Taped, Ammo pack pcs.			Kinked leads, bulk pcs.	Cut leads, bulk pcs.
18 x 20	250	250			100	100
18 x 25	250	250			100	100
18 x 31.5	250	250			100	100
18 x 35.5	250	–			100	100
18 x 40	250	–			100	100
The last three digits of the complete ordering code state the lead configuration	<b>000</b>	Code	F (mm)	d (mm)	<b>001</b>	<b>002</b>
		009	7.5	16 ... 18		



**B41866**

**High ripple current – 125 °C**

**Overview of packing units and code numbers for case sizes 8 × 11.5 ... 16 × 35.5**

Valid for series B41858, B41859, B41863, B41866, B41868, B41888, B41890, B41896, B42824, B42851, B43866, B43867, B43890, B43896.

					<b>PAPR</b>				
Case size d × l	Standard, bulk	Taped, Ammo pack		Kinked leads, bulk	Cut leads, bulk	Crimped leads, blister	J leads, blister	Bent 90° leads, blister	
mm	pcs.	pcs.		pcs.	pcs.	pcs.	pcs.	pcs.	
8 × 11.5	1000	1000		–	–	–	–		
10 × 12.5	1000	750		–	1000	–	675		
10 × 16	1000	500		–	1000	–	675		
10 × 20	500	500		500	500	–	500		
12.5 × 20	350	500		350	350	–	300	1)	
12.5 × 25	250	500		500	500	–	225	1)	
12.5 × 30	200	–		–	–	–	–		
12.5 × 35	175	–		–	–	–	–		
12.5 × 40	175	–		–	–	–	–		
16 × 20	250	300		200	200	200	200	120	
16 × 25	250	300		200	200	200	200	120	
16 × 31.5	200	300		250	250	344	344	120	
16 × 35.5	100	–		100	100	150	150	150	
The last three digits of the complete ordering code state the lead configuration	<b>000</b>	Code	F (mm)	d (mm)	<b>001</b>	<b>002</b>	<b>003</b>	<b>004</b>	<b>012</b>
		<b>006</b>	3.5	8					
		<b>008</b>	5	5...12.5					
		<b>009</b>	7.5	16...18					

1) Available upon request



**Overview of packing units and code numbers for case sizes 18 × 20 ... 18 × 40**

Valid for series B41858, B41859, B41863, B41866, B41868, B41888, B41890, B41896, B42824, B42851, B43866, B43867, B43890, B43896.

					<b>PAPR</b>				
Case size d × l  mm	Standard, bulk pcs.	Taped, Ammo pack pcs.			Kinked leads, bulk pcs.	Cut leads, bulk pcs.	Crimped leads, blister pcs.	J leads, blister pcs.	Bent 90° leads, blister pcs.
18 × 20	175	250			175	175	200	200	120
18 × 25	150	250			150	150	200	200	120
18 × 31.5	100	250			100	100	150	150	120
18 × 35	100	–			100	100	150	150	150
18 × 40	125	–			100	100	120	–	72
The last three digits of the complete ordering code state the lead configuration	<b>000</b>	Code	F (mm)	d (mm)	<b>001</b>	<b>002</b>	<b>003</b>	<b>004</b>	<b>012</b>
		<b>009</b>	7.5	16...18					



B41866

High ripple current – 125 °C

## Cautions and warnings

### Personal safety

The electrolytes used by EPCOS have not only been optimized with a view to the intended application, but also with regard to health and environmental compatibility. They do not contain any solvents that are detrimental to health, e.g. dimethyl formamide (DMF) or dimethyl acetamide (DMAC).

Furthermore, part of the high-voltage electrolytes used by EPCOS are self-extinguishing. They contain flame-retarding substances which will quickly extinguish any flame that may have been ignited.

As far as possible, EPCOS does not use any dangerous chemicals or compounds to produce operating electrolytes. However, in exceptional cases, such materials must be used in order to achieve specific physical and electrical properties because no safe substitute materials are currently known. However, the amount of dangerous materials used in our products has been limited to an absolute minimum. Nevertheless, the following rules should be observed when handling aluminum electrolytic capacitors:

- Any escaping electrolyte should not come into contact with eyes or skin.
- If electrolyte does come into contact with the skin, wash the affected parts immediately with running water. If the eyes are affected, rinse them for 10 minutes with plenty of water. If symptoms persist, seek medical treatment.
- Avoid breathing in electrolyte vapor or mists. Workplaces and other affected areas should be well ventilated. Clothing that has been contaminated by electrolyte must be changed and rinsed in water.



## Product safety

The table below summarizes the safety instructions that must be observed without fail. A detailed description can be found in the relevant sections of chapter "General technical information".

Topic	Safety information	Reference chapter "General technical information"
Polarity	Make sure that polar capacitors are connected with the right polarity.	1 "Basic construction of aluminum electrolytic capacitors"
Reverse voltage	Voltages polarity classes should be prevented by connecting a diode.	3.1.6 "Reverse voltage"
Upper category temperature	Do not exceed the upper category temperature.	7.2 "Maximum permissible operating temperature"
Maintenance	Make periodic inspections of the capacitors. Before the inspection, make sure that the power supply is turned off and carefully discharge the electricity of the capacitors. Do not apply any mechanical stress to the capacitor terminals.	10 "Maintenance"
Mounting position of screw-terminal capacitors	Do not mount the capacitor with the terminals (safety vent) upside down.	11.1. "Mounting positions of capacitors with screw terminals"
Mounting of single-ended capacitors	The internal structure of single-ended capacitors might be damaged if excessive force is applied to the lead wires. Avoid any compressive, tensile or flexural stress. Do not move the capacitor after soldering to PC board. Do not pick up the PC board by the soldered capacitor. Do not insert the capacitor on the PC board with a hole space different to the lead space specified.	11.4 "Mounting considerations for single-ended capacitors"
Robustness of terminals	The following maximum tightening torques must not be exceeded when connecting screw terminals: M5: 2 Nm M6: 2.5 Nm	11.3 "Mounting torques"
Soldering	Do not exceed the specified time or temperature limits during soldering.	11.5 "Soldering"



**B41866**

**High ripple current – 125 °C**

Topic	Safety information	Reference chapter "General technical information"
Soldering, cleaning agents	Do not allow halogenated hydrocarbons to come into contact with aluminum electrolytic capacitors.	11.6 "Cleaning agents"
Passive flammability	Avoid external energy, such as fire or electricity.	8.1 "Passive flammability"
Active flammability	Avoid overload of the capacitors.	8.2 "Active flammability"
		Reference chapter "Capacitors with screw terminals"
Breakdown strength of insulating sleeves	Do not damage the insulating sleeve, especially when ring clips are used for mounting.	"Screw terminals – accessories"

**Symbols and terms**

Symbol	English	German
C	Capacitance	Kapazität
$C_R$	Rated capacitance	Nennkapazität
$C_S$	Series capacitance	Serienkapazität
$C_{S,T}$	Series capacitance at temperature T	Serienkapazität bei Temperatur T
$C_f$	Capacitance at frequency f	Kapazität bei Frequenz f
d	Case diameter, nominal dimension	Gehäusedurchmesser, Nennmaß
$d_{max}$	Maximum case diameter	Maximaler Gehäusedurchmesser
ESL	Self-inductance	Eigeninduktivität
ESR	Equivalent series resistance	Ersatzserienwiderstand
$ESR_f$	Equivalent series resistance at frequency f	Ersatzserienwiderstand bei Frequenz f
$ESR_T$	Equivalent series resistance at temperature T	Ersatzserienwiderstand bei Temperatur T
f	Frequency	Frequenz
I	Current	Strom
$I_{AC}$	Alternating current (ripple current)	Wechselstrom
$I_{AC,rms}$	Root-mean-square value of alternating current	Wechselstrom, Effektivwert
$I_{AC,f}$	Ripple current at frequency f	Wechselstrom bei Frequenz f
$I_{AC,max}$	Maximum permissible ripple current	Maximal zulässiger Wechselstrom
$I_{AC,R}$	Rated ripple current	Nennwechselstrom
$I_{AC,R} (B)$	Rated ripple current for base cooling	Nennwechselstromstrom für Bodenkühlung
$I_{leak}$	Leakage current	Reststrom
$I_{leak,op}$	Operating leakage current	Betriebsreststrom
l	Case length, nominal dimension	Gehäuselänge, Nennmaß
$l_{max}$	Maximum case length (without terminals and mounting stud)	Maximale Gehäuselänge (ohne Anschlüsse und Gewindebolzen)
R	Resistance	Widerstand
$R_{ins}$	Insulation resistance	Isolationswiderstand
$R_{symm}$	Balancing resistance	Symmetrierwiderstand
T	Temperature	Temperatur
$\Delta T$	Temperature difference	Temperaturdifferenz
$T_A$	Ambient temperature	Umgebungstemperatur
$T_C$	Case temperature	Gehäusetemperatur
$T_B$	Capacitor base temperature	Temperatur des Becherbodens
t	Time	Zeit
$\Delta t$	Period	Zeitraum
$t_b$	Service life (operating hours)	Brauchbarkeitsdauer (Betriebszeit)

**B41866**
**High ripple current – 125 °C**

Symbol	English	German
V	Voltage	Spannung
V <sub>F</sub>	Forming voltage	Formierspannung
V <sub>op</sub>	Operating voltage	Betriebsspannung
V <sub>R</sub>	Rated voltage, DC voltage	Nennspannung, Gleichspannung
V <sub>S</sub>	Surge voltage	Spitzenspannung
X <sub>C</sub>	Capacitive reactance	Kapazitiver Blindwiderstand
X <sub>L</sub>	Inductive reactance	Induktiver Blindwiderstand
Z	Impedance	Scheinwiderstand
Z <sub>T</sub>	Impedance at temperature T	Scheinwiderstand bei Temperatur T
tan δ	Dissipation factor	Verlustfaktor
λ	Failure rate	Ausfallrate
ε <sub>0</sub>	Absolute permittivity	Elektrische Feldkonstante
ε <sub>r</sub>	Relative permittivity	Dielektrizitätszahl
ω	Angular velocity; $2 \cdot \pi \cdot f$	Kreisfrequenz; $2 \cdot \pi \cdot f$

**Note**

All dimensions are given in mm.

## Important notes

The following applies to all products named in this publication:

1. Some parts of this publication contain **statements about the suitability of our products for certain areas of application**. These statements are based on our knowledge of typical requirements that are often placed on our products in the areas of application concerned. We nevertheless expressly point out **that such statements cannot be regarded as binding statements about the suitability of our products for a particular customer application**. As a rule, EPCOS is either unfamiliar with individual customer applications or less familiar with them than the customers themselves. For these reasons, it is always ultimately incumbent on the customer to check and decide whether an EPCOS product with the properties described in the product specification is suitable for use in a particular customer application.
2. We also point out that **in individual cases, a malfunction of electronic components or failure before the end of their usual service life cannot be completely ruled out in the current state of the art, even if they are operated as specified**. In customer applications requiring a very high level of operational safety and especially in customer applications in which the malfunction or failure of an electronic component could endanger human life or health (e.g. in accident prevention or lifesaving systems), it must therefore be ensured by means of suitable design of the customer application or other action taken by the customer (e.g. installation of protective circuitry or redundancy) that no injury or damage is sustained by third parties in the event of malfunction or failure of an electronic component.
3. **The warnings, cautions and product-specific notes must be observed.**
4. In order to satisfy certain technical requirements, **some of the products described in this publication may contain substances subject to restrictions in certain jurisdictions (e.g. because they are classed as hazardous)**. Useful information on this will be found in our Material Data Sheets on the Internet ([www.epcos.com/material](http://www.epcos.com/material)). Should you have any more detailed questions, please contact our sales offices.
5. We constantly strive to improve our products. Consequently, **the products described in this publication may change from time to time**. The same is true of the corresponding product specifications. Please check therefore to what extent product descriptions and specifications contained in this publication are still applicable before or when you place an order. We also **reserve the right to discontinue production and delivery of products**. Consequently, we cannot guarantee that all products named in this publication will always be available. The aforementioned does not apply in the case of individual agreements deviating from the foregoing for customer-specific products.
6. Unless otherwise agreed in individual contracts, **all orders are subject to the current version of the "General Terms of Delivery for Products and Services in the Electrical Industry" published by the German Electrical and Electronics Industry Association (ZVEI)**.
7. The trade names EPCOS, BAOKE, Alu-X, CeraDiode, CSMP, CSSP, CTVS, DeltaCap, DigiSiMic, DSSP, FormFit, MiniBlue, MiniCell, MKK, MKD, MLSC, MotorCap, PCC, PhaseCap, PhaseCube, PhaseMod, PhiCap, SIFERRIT, SIFI, SIKOREL, SilverCap, SIMDAD, SiMic, SIMID, SineFormer, SIOV, SIP5D, SIP5K, ThermoFuse, WindCap are **trade-marks registered or pending** in Europe and in other countries. Further information will be found on the Internet at [www.epcos.com/trademarks](http://www.epcos.com/trademarks).