



### FEATURES

- Wideband switch: -3 dB @ 2.5 GHz
  - ADG904: absorptive 4:1 mux/SP4T
  - ADG904-R: reflective 4:1 mux/SP4T
  - High off isolation (37 dB @ 1 GHz)
  - Low insertion loss (1.1 dB dc to 1 GHz)
  - Single 1.65 V to 2.75 V power supply
  - CMOS/LVTTL control logic
  - 20-lead TSSOP and 4 mm x 4 mm LFCSP packages
  - Low power consumption (1  $\mu$ A maximum)
  - Qualified for automotive applications
- ### APPLICATIONS

- Wireless communications
  - General-purpose RF switching
  - Dual-band applications
  - High speed filter selection
  - Digital transceiver front end switch
  - IF switching
  - Tuner modules
  - Antenna diversity switching
- ### GENERAL DESCRIPTION

The ADG904 and ADG904-R are wideband analog 4:1 multiplexers that use a CMOS process to provide high isolation and low insertion loss to 1 GHz. The ADG904 is an absorptive/matched mux with 50  $\Omega$  terminated shunt legs; the ADG904-R is a reflective mux. These devices are designed such that the isolation is high over the dc to 1 GHz frequency range.

The ADG904 and ADG904-R switch one of four inputs to a common output, RFC, as determined by the 3-bit binary address lines A0, A1, and EN. A Logic 1 on the EN pin disables the device.

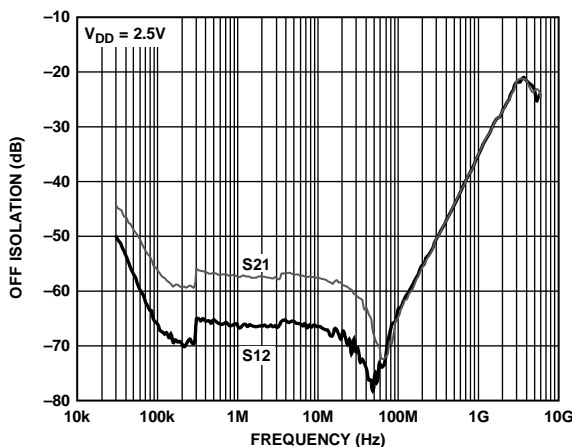

Figure 3. Off Isolation vs. Frequency

04504-0-028

### FUNCTIONAL BLOCK DIAGRAMS



Figure 1.

04504-0-001



Figure 2.

04504-0-012

The parts have on-board CMOS control logic, which eliminates the need for external control circuitry. The control inputs are both CMOS and LVTTL compatible. The low power consumption of these devices makes them ideally suited for wireless applications and general-purpose high frequency switching.

### PRODUCT HIGHLIGHTS

- 37 dB off isolation @ 1 GHz
- 1.1 dB insertion loss @ 1 GHz
- 20-lead TSSOP/LFCSP packages

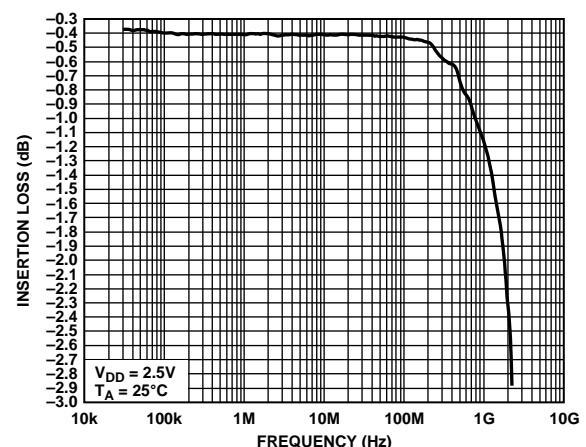

Figure 4. Insertion Loss vs. Frequency

04504-0-029

Rev. D

[Document Feedback](#)

Information furnished by Analog Devices is believed to be accurate and reliable. However, no responsibility is assumed by Analog Devices for its use, nor for any infringements of patents or other rights of third parties that may result from its use. Specifications subject to change without notice. No license is granted by implication or otherwise under any patent or patent rights of Analog Devices. Trademarks and registered trademarks are the property of their respective owners.

## TABLE OF CONTENTS

Features .....	1	Test Circuits.....	9
Applications.....	1	Applications.....	11
Functional Block Diagrams.....	1	Absorptive vs. Reflective .....	11
General Description .....	1	Antenna Diversity Switch.....	11
Product Highlights .....	1	Filter Selection .....	11
Specifications.....	3	Tx/Rx Switching .....	11
Absolute Maximum Ratings.....	4	Evaluation Board .....	12
ESD Caution.....	4	Outline Dimensions .....	13
Pin Configurations and Function Descriptions .....	5	Ordering Guide .....	14
Terminology .....	6	Automotive Products.....	14
Typical Performance Characteristics .....	7		

### REVISION HISTORY

#### 9/2016—Rev. C to Rev. D

Change to Product Title.....	1
Changes to Figure 3.....	1
Changes to Figure 11 and 12.....	7
Changes to Figure 19.....	9
Change to Ordering Guide.....	14

#### 3/2013—Rev. B to Rev. C

Changes to Features Section.....	1
Changes to Figure 6.....	5
Updated Outline Dimensions .....	13
Changes to Ordering Guide .....	14
Added Automotive Product Section .....	14

#### 2/2007—Rev. A to Rev. B

Updated Outline Dimensions.....	13
Changes to Ordering Guide.....	14

#### 8/2005—Rev. 0 to Rev. A

Added LFCSP Package.....	Universal
Changes to Specifications.....	3
Changes to Absolute Maximum Ratings.....	4
Inserted New Figure 6.....	5
Changes to Table 4.....	5
Changes to Outline Dimensions .....	13
Changes to Ordering Guide .....	14

#### 4/2004—Revision 0: Initial Version

## SPECIFICATIONS

V<sub>DD</sub> = 1.65 V to 2.75 V, GND = 0 V, Input Power = 0 dBm, all specifications T<sub>MIN</sub> to T<sub>MAX</sub>, unless otherwise noted.<sup>1</sup>

Table 1.

Parameter	Symbol	Conditions	B Version			Unit
			Min	Typ <sup>2</sup>	Max	
AC ELECTRICAL CHARACTERISTICS						
Operating Frequency <sup>3</sup>			DC		2	GHz
3 dB Frequency <sup>4</sup>					2.5	GHz
Input Power <sup>4</sup>		0 V dc bias			7	dBm
		0.5 V dc bias			16	dBm
Insertion Loss	S <sub>21</sub> , S <sub>12</sub>	DC to 100 MHz; V <sub>DD</sub> = 2.5 V ± 10%		0.4	0.8	dB
		500 MHz; V <sub>DD</sub> = 2.5 V ± 10%		0.6	0.9	dB
		1000 MHz; V <sub>DD</sub> = 2.5 V ± 10%		1.1	1.5	dB
Isolation—RFC to RF1–RF4	S <sub>21</sub> , S <sub>12</sub>	100 MHz	51	60		dB
		500 MHz	35	45		dB
		1000 MHz	30	37		dB
Crosstalk	S <sub>21</sub> , S <sub>12</sub>	100 MHz	50	58		dB
		500 MHz	35	32		dB
		1000 MHz	30	35		dB
Return Loss (On Channel) <sup>4</sup>	S <sub>11</sub> , S <sub>22</sub>	DC to 100 MHz	21	27		dB
		500 MHz	18	26		dB
		1000 MHz	15	30		dB
Return Loss (Off Channel) <sup>4</sup>	S <sub>11</sub> , S <sub>22</sub>	DC to 100 MHz	18	22		dB
		500 MHz	16	23		dB
		1000 MHz	18	22		dB
On Switching Time <sup>4</sup>	t <sub>ON (EN)</sub>	50% EN to 90% RF		8.5	10	ns
Off Switching Time <sup>4</sup>	t <sub>OFF (EN)</sub>	50% EN to 10% RF		13	16	ns
Transition Time	t <sub>TRANS</sub>	50% A <sub>x</sub> to 10% RF		12	15	ns
Rise Time <sup>4</sup>	t <sub>RISE</sub>	10% to 90% RF		3	5	ns
Fall Time <sup>4</sup>	t <sub>FALL</sub>	90% to 10% RF		7.5	9	ns
1 dB Compression <sup>4</sup>	P <sub>-1 dB</sub>	1000 MHz		16		dBm
Third-Order Intermodulation Intercept	IP <sub>3</sub>	900 MHz/901 MHz, 4 dBm	26.5	31		dBm
Video Feedthrough <sup>5</sup>				3		mV p-p
DC ELECTRICAL CHARACTERISTICS						
Input High Voltage	V <sub>INH</sub>	V <sub>DD</sub> = 2.25 V to 2.75 V	1.7			V
	V <sub>INH</sub>	V <sub>DD</sub> = 1.65 V to 1.95 V	0.65 V <sub>CC</sub>			V
Input Low Voltage	V <sub>INL</sub>	V <sub>DD</sub> = 2.25 V to 2.75 V			0.7	V
	V <sub>INL</sub>	V <sub>DD</sub> = 1.65 V to 1.95 V			0.35 V <sub>CC</sub>	V
Input Leakage Current	I <sub>I</sub>	0 ≤ V <sub>IN</sub> ≤ 2.75 V		± 0.1	± 1	μA
CAPACITANCE <sup>4</sup>						
RF Port On Capacitance	C <sub>RF ON</sub>	f = 1 MHz		3		pF
Digital Input Capacitance	C	f = 1 MHz		2		pF
POWER REQUIREMENTS						
V <sub>DD</sub>			1.65		2.75	V
Quiescent Power Supply Current	I <sub>DD</sub>	Digital inputs = 0 V or V <sub>DD</sub>		0.1	1	μA

<sup>1</sup> Temperature range B version: -40°C to +85°C.

<sup>2</sup> Typical values are at V<sub>DD</sub> = 2.5 V and 25°C, unless otherwise stated.

<sup>3</sup> Operating frequency is the point at which insertion loss degrades by 1.5 dB.

<sup>4</sup> Guaranteed by design, not subject to production test.

<sup>5</sup> Video feedthrough is the dc transience at the output of any port of the switch when the control voltage is switched from high to low or low to high in a 50 Ω test setup, measured with 1 ns rise time pulses and 500 MHz bandwidth.

## ABSOLUTE MAXIMUM RATINGS

$T_A = 25^\circ\text{C}$ , unless otherwise noted.

Table 2.

Parameter	Rating
$V_{DD}$ to GND	-0.5 V to +4 V
Inputs to GND	-0.5 V to $V_{DD} + 0.3\text{ V}^1$
Continuous Current	30 mA
Input Power	18 dBm
Operating Temperature Range	
Industrial (B Version)	$-40^\circ\text{C}$ to $+85^\circ\text{C}$
Storage Temperature Range	$-65^\circ\text{C}$ to $+150^\circ\text{C}$
Junction Temperature	$150^\circ\text{C}$
TSSOP Package	
$\theta_{JA}$ Thermal Impedance	$143^\circ\text{C/W}$
LFCSP Package	
$\theta_{JA}$ Thermal Impedance (4-Layer Board)	$30.4^\circ\text{C/W}$
Lead Temperature, Soldering (10 sec)	$300^\circ\text{C}$
IR Reflow, Peak Temperature (<20 sec)	$235^\circ\text{C}$
ESD	1 kV

<sup>1</sup> RFx off port inputs to ground =  $-0.5\text{ V}$  to  $V_{DD} - 0.5\text{ V}$ .

### ESD CAUTION

ESD (electrostatic discharge) sensitive device. Electrostatic charges as high as 4000V readily accumulate on the human body and test equipment and can discharge without detection. Although this product features proprietary ESD protection circuitry, permanent damage may occur on devices subjected to high energy electrostatic discharges. Therefore, proper ESD precautions are recommended to avoid performance degradation or loss of functionality.



Stresses at or above those listed under Absolute Maximum Ratings may cause permanent damage to the product. This is a stress rating only; functional operation of the product at these or any other conditions above those indicated in the operational section of this specification is not implied. Operation beyond the maximum operating conditions for extended periods may affect product reliability.

Table 3. Truth Table

A1	A0	$\overline{\text{EN}}$	ON Switch <sup>1</sup>
X	X	1	None
0	0	0	RF1
0	1	0	RF2
1	0	0	RF3
1	1	0	RF4

<sup>1</sup> Off switches have:  $50\ \Omega$  termination to GND (ADG904); shunt to GND (ADG904-R).

# PIN CONFIGURATIONS AND FUNCTION DESCRIPTIONS



Figure 5. 20-Lead TSSOP (RU-20)



NOTES  
1. THE EXPOSED PAD IS TIED TO SUBSTRATE,  $V_{SS}$ .

Figure 6. 20-Lead 4 mm x 4mm LFCSP (CP-20-6)

Table 4. Pin Function Descriptions

Pin No.		Mnemonic	Function
20-Lead TSSOP	20-Lead LFCSP		
1	18	EN	Active Low Digital Input. When high, the device is disabled and all switches are off. When low, Ax logic inputs determine On switches.
2	19	$V_{DD}$	Power Supply Input. These parts can be operated from 1.65 V to 2.75 V. $V_{DD}$ should be decoupled to GND.
3, 5, 6, 8, 9, 11, 12, 13, 15, 16, 18	1, 3, 4, 6, 7, 9, 10, 12, 13, 15, 20	GND	Ground Reference Point for All Circuitry on the Part.
4	2	RF1	RF1 Port.
7	5	RF3	RF3 Port.
10	8	RFC	Common RF Port for Switch.
14	11	RF4	RF4 Port.
17	14	RF2	RF2 Port.
19	16	A1	Logic Control Input.
20	17	A0	Logic Control Input.
N/A	21	EPAD	Exposed Pad. The exposed pad is tied to substrate, $V_{SS}$ .

## TERMINOLOGY

Table 5.

Parameter	Description
V <sub>DD</sub>	Most Positive Power Supply Potential.
I <sub>DD</sub>	Positive Supply Current.
GND	Ground (0 V) Reference.
AX	Logic Control Input.
V <sub>INL</sub>	Maximum Input Voltage for Logic 0.
V <sub>INH</sub>	Minimum Input Voltage for Logic 1.
I <sub>INL</sub> (I <sub>INH</sub> )	Input Current of the Digital Input.
C <sub>IN</sub>	Digital Input Capacitance.
t <sub>ON</sub> ( $\overline{\text{EN}}$ )	Delay between Applying the $\overline{\text{EN}}$ Control Input and the Output Switching On.
t <sub>OFF</sub> ( $\overline{\text{EN}}$ )	Delay between Applying the $\overline{\text{EN}}$ Control Input and the Output Switching Off.
t <sub>RISE</sub>	Rise Time. Time for the RF signal to rise from 10% of the on level to 90% of the on level.
t <sub>FALL</sub>	Fall Time. Time for the RF signal to fall from 90% of the on level to 10% of the on level.
t <sub>TRANS</sub>	Transition Time. Delay between applying the digital control input and the output switching on.
Off Isolation	The Attenuation between Input and Output Ports of the Switch when the Switch Control Voltage is in the Off Condition.
Insertion Loss	The Attenuation between Input and Output Ports of the Switch when the Switch Control Voltage is in the On Condition.
Crosstalk	Measure of Unwanted Signal Coupled through from One Channel to Another as a Result of Parasitic Capacitance.
P <sub>-1 dB</sub>	1 dB Compression Point. The RF input power level at which the switch insertion loss increases by 1 dB over its low level value. P <sub>-1 dB</sub> is a measure of how much power the on switch can handle before the insertion loss increases by 1 dB.
IP <sub>3</sub>	Third-Order Intermodulation Intercept. This is a measure of the power in false tones that occur when closely spaced tones are passed through a switch, and the nonlinearity of the switch causes these false tones to be generated.
Return Loss	The Amount of Reflected Power Relative to the Incident Power at a Port. Large return loss indicates good matching. By measuring return loss, the voltage standing wave ratio (VSWR) can be calculated from conversion charts. VSWR indicates the degree of matching present at a switch RF port.
Video Feedthrough	Spurious Signals Present at the RF Ports of the Switch when the Control Voltage Is Switched from High to Low or Low to High without an RF Signal Present.

TYPICAL PERFORMANCE CHARACTERISTICS

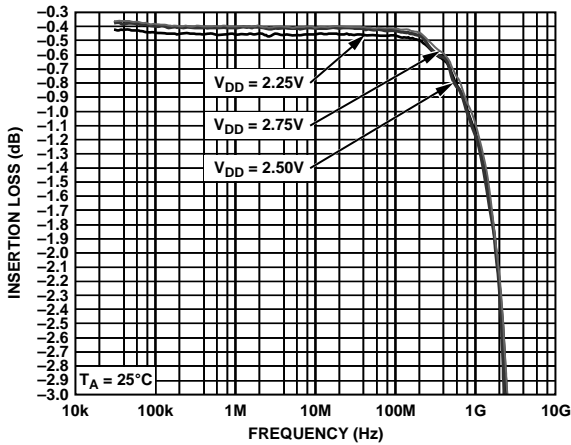

Figure 7. Insertion Loss vs. Frequency over Supplies (RF1-RF4, S12, and S21)

04504-0-015

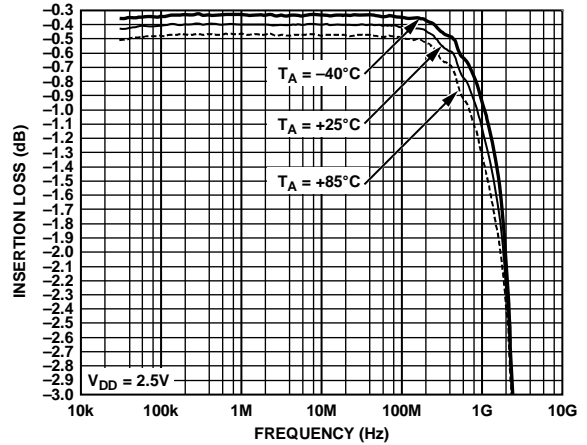

Figure 10. Insertion Loss vs. Frequency over Temperature ((RF1-RF4, S12, and S21)

04504-0-016



Figure 8. Insertion Loss vs. Frequency over Supplies (RF1-RF4, S12, and S21). Zoomed Figure 7 Plot

04504-0-014



Figure 11. Isolation vs. Frequency over Supplies (RF1-RF4, S12, and S21)

04504-0-017

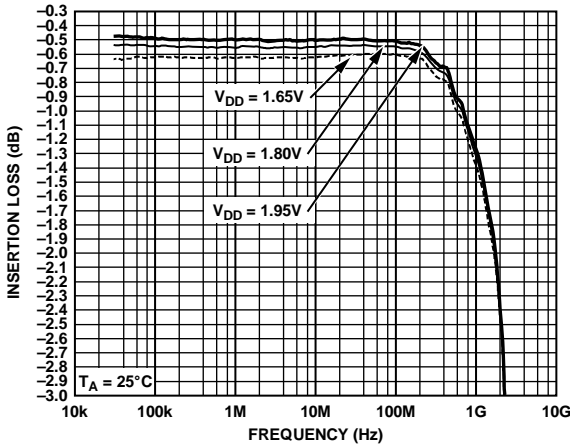

Figure 9. Insertion Loss vs. Frequency over Supplies (RF1-RF4, S12, and S21)

04504-0-013

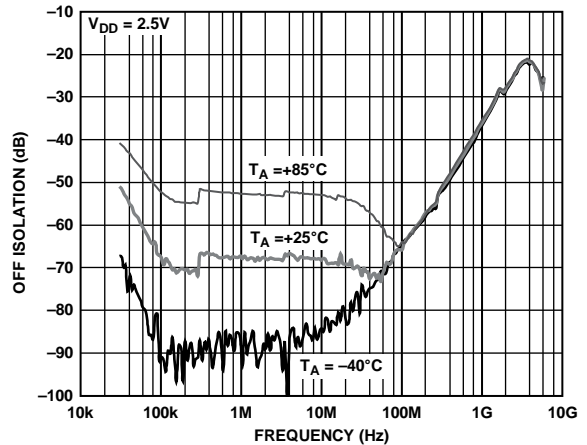

Figure 12. Isolation vs. Frequency over Temperature (RF1-RF4, S12, and S21)

04504-0-018



Figure 13. Return Loss vs. Frequency (RF1–RF4, S11)



Figure 16. Video Feedthrough



Figure 14. Crosstalk vs. Frequency



Figure 17. IP3 vs. Frequency



Figure 15. Switch Timing



Figure 18. P-1 dB vs. Frequency



TEST CIRCUITS



Figure 19. Switch Timing:  $t_{ON}$ ,  $t_{OFF}$

04504-0-004



Figure 22. Insertion Loss

04504-0-007



Figure 20. Switch Timing:  $t_{RISE}$ ,  $t_{FALL}$

04504-0-005



Figure 23. Crosstalk

04504-0-008



Figure 21. Off Isolation

04504-0-006

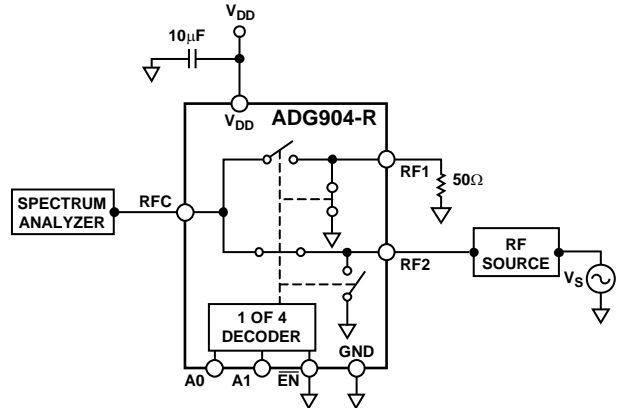

Figure 24. Video Feedthrough

04504-0-009



04504-0-010



04504-0-011

## APPLICATIONS

The ADG904 and ADG904-R are ideal solutions for low power, high frequency applications. The low insertion loss, high isolation between ports, low distortion, and low current consumption of these parts make them excellent solutions for many high frequency switching applications. They may be used in applications such as switchable filters, transmitters and receivers for radar systems, and communications systems from base stations to cell phones.

The ADG9xx wideband switches are designed to meet the demands of devices that transmit at ISM band frequencies of 1 GHz and higher. The low insertion loss, high isolation between ports, single pin control interface, no requirement for dc blocking capacitors, and TTL interface compatibility of these parts make them cost-effective and an easy-to-integrate switching solution for many high frequency switching applications and low power applications where the parts can handle up to 16 dBm of power.

### ABSORPTIVE VS. REFLECTIVE

The ADG904 is an absorptive (matched) switch with 50 Ω terminated shunt legs; the ADG904-R is a reflective switch with 0 Ω terminated shunts to ground. The ADG904 absorptive switch has a good VSWR on each port, regardless of the switch mode. An absorptive switch should be used when there is a need for a good VSWR that is looking into the port but not passing the through signal to the common port. The ADG904 is therefore ideal for applications that require minimum reflections back to the RF source. It also ensures that the maximum power is transferred to the load.

The ADG904-R reflective switch is suitable for applications where high off port VSWR does not matter, and the switch has other performance features. It may be used in many applications, including high speed filter selection. In most cases, an absorptive switch may be used instead of a reflective switch, but not vice versa.

### ANTENNA DIVERSITY SWITCH

The ADG904 is ideal for use as an antenna diversity switch, switching different antennas into the tuner. The low insertion loss ensures minimum signal loss and high isolation between channels, making these SP4T switches suitable for switching applications in tuner modules and set-top boxes.



Figure 27. Tuner Modules

04504-0-021

### FILTER SELECTION

The ADG904 can be used to switch high frequency signals between different filters and to multiplex the signal to the output. These SP4T switches are also ideal for high speed signal routing.



Figure 28. Filter Selection

04504-0-022

### Tx/Rx SWITCHING

The low insertion loss and high isolation between ports ensure that the ADG904 and ADG904-R are suitable transmit/receive switches for all ISM band and wireless LAN, providing the required isolation between the transmit signal and the receive signal.

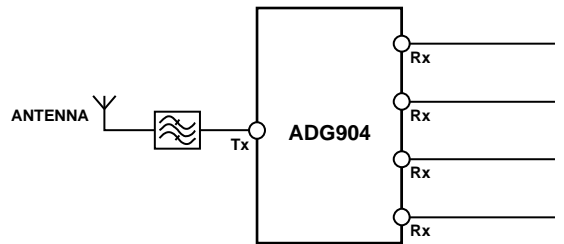

Figure 29. Tx/Rx Switching

04504-0-023

## EVALUATION BOARD

The ADG904/ADG904-R evaluation board allows designers to evaluate the high performance, wideband switches with minimal effort.

Only a power supply and a network analyzer, along with the evaluation board, are required to demonstrate that these devices meet user requirements. An application note, available with the evaluation board, provides complete operating information.

The RFC port (see Figure 30) is connected through a 50 Ω transmission line to the bottom left SMA connector, J4. RF1, RF2, RF3, and RF4 are connected through 50 Ω transmission lines to SMA connectors J5, J6, J7, and J8, respectively. A through transmission line connects J9 and J10; this transmission line is used to estimate the loss of the PCB over the environmental conditions being evaluated.

The board is constructed of four-layer, FR4 material with a dielectric constant of 4.3 and an overall thickness of 0.062 inches. Two ground layers with grounded planes provide ground for the RF transmission lines. The transmission lines were designed using a coplanar waveguide with a ground plane model using a trace width of 0.024 inches, clearance to ground plane of 0.008 inches, dielectric thickness of 0.02 inches, and a metal thickness of 0.0021 inches.



Figure 30. ADG904/ADG904-R Evaluation Board Top View

04504-0-024

# OUTLINE DIMENSIONS

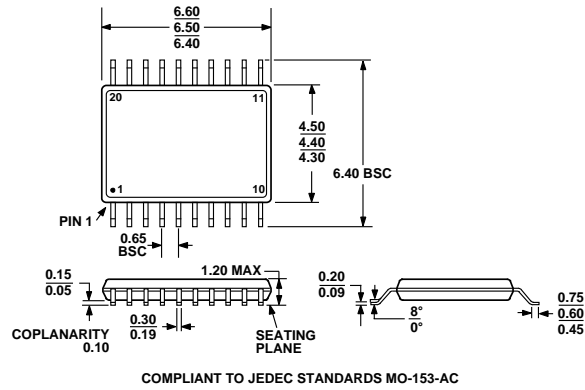

COMPLIANT TO JEDEC STANDARDS MO-153-AC  
 Figure 31. 20-Lead Thin Shrink Small Outline Package [TSSOP]  
 (RU-20)  
 Dimensions shown in millimeters



COMPLIANT TO JEDEC STANDARDS MO-220-WGGD-1.  
 Figure 32. 20-Lead Lead Frame Chip Scale Package [LFCSP\_WQ]  
 4 mm × 4 mm Body, Very Very Thin Quad  
 (CP-20-6)  
 Dimensions shown in millimeters

08-16-2010-B

**ORDERING GUIDE**

Model <sup>1, 2</sup>	Temperature Range	Package Description	Package Option
ADG904BCPZ	-40°C to +85°C	20-Lead Lead Frame Chip Scale Package [LFCSP_WQ]	CP-20-6
ADG904BCPZ-REEL	-40°C to +85°C	20-Lead Lead Frame Chip Scale Package [LFCSP_WQ]	CP-20-6
ADG904BCPZ-REEL7	-40°C to +85°C	20-Lead Lead Frame Chip Scale Package [LFCSP_WQ]	CP-20-6
ADG904BRUZ	-40°C to +85°C	20-Lead Thin Shrink Small Outline Package [TSSOP]	RU-20
ADG904BRUZ-R	-40°C to +85°C	20-Lead Thin Shrink Small Outline Package (TSSOP)	RU-20
ADG904BRUZ-REEL7	-40°C to +85°C	20-Lead Thin Shrink Small Outline Package (TSSOP)	RU-20
ADW54011Z-0REEL7	-40°C to +85°C	20-Lead Thin Shrink Small Outline Package (TSSOP)	RU-20
EVAL-ADG904EBZ		Evaluation Board	
EVAL-ADG904REBZ		Evaluation Board	

<sup>1</sup> Z = RoHS compliant part.

<sup>2</sup> W = Qualified for Automotive Applications.

**AUTOMOTIVE PRODUCTS**

The ADW54011Z model is available with controlled manufacturing to support the quality and reliability requirements of automotive applications. Note that this automotive model may have specifications that differ from the commercial models; therefore, designers should review the Specifications section of this data sheet carefully. Only the automotive grade product shown are available for use in automotive applications. Contact your local Analog Devices account representative for specific product ordering information and to obtain the specific Automotive Reliability reports for this model.

**NOTES**

**NOTES**



# Mouser Electronics

Authorized Distributor

Click to View Pricing, Inventory, Delivery & Lifecycle Information:

## [Analog Devices Inc.:](#)

[ADW54011Z-0REEL7](#) [EVAL-ADG904EBZ](#) [EVAL-ADG904REBZ](#) [ADG904BCPZ](#) [ADG904BRUZ-R](#) [ADG904BRUZ](#)  
[ADG904BRUZ-REEL7](#) [ADG904BCPZ-REEL](#) [ADG904BCPZ-REEL7](#) [ADG904SCPZ-EP](#) [ADG904SCPZ-EP-RL7](#)