

**FEATURES**
**Ultralow on resistance**

- 0.28  $\Omega$  typical
- 0.48  $\Omega$  max at 125°C

**Excellent audio performance, ultralow distortion**

- 0.025  $\Omega$  typical
- 0.052  $\Omega$  max  $R_{ON}$  flatness

**1.65 V to 3.6 V single supply**
**High current carrying capability**

- 300 mA continuous current
- 500 mA peak current

**Automotive temperature range: -40°C to +125°C**
**Rail-to-rail operation**
**Typical power consumption (<0.01  $\mu$ W)**
**APPLICATIONS**

- Handsets
- PDA's
- MP3 players
- Power routing
- Battery-powered systems
- Communication systems
- Modems
- PCMCIA cards

**GENERAL DESCRIPTION**

The ADG841 and ADG842 are low voltage CMOS devices containing a single-pole, single-throw (SPST) switch. The ADG841 is closed for a Logic 1 input and the ADG842 is open for a Logic 1 input. The devices offer ultralow on resistance of less than 0.48  $\Omega$  over the full temperature range. The ADG841/ADG842 are fully specified for 3.3 V, 2.5 V, and 1.8 V supply operation.

Each switch conducts equally well in both directions when on, and has an input signal range that extends to the supplies. The ADG841/ADG842 exhibit break-before-make switching action.

The ADG841/ADG842 are available in a 6-lead SC70 package.

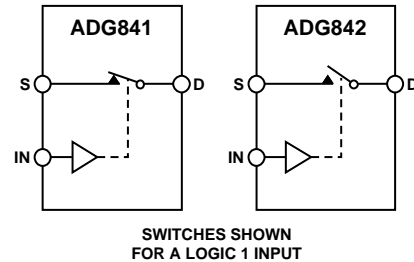
**FUNCTIONAL BLOCK DIAGRAM**

065424-001
*Figure 1.*
**PRODUCT HIGHLIGHTS**

1. <0.48  $\Omega$  over full temperature range of -40°C to +125°C.
2. Compatible with 1.8 V CMOS logic.
3. High current handling capability (300 mA continuous current at 3.3 V).
4. Low THD + N (0.02% typ).
5. Tiny SC70 package.

**Table 1. ADG841/ADG842 Truth Table**

Logic (IN)	ADG841	ADG842
0	Off	On
1	On	Off

**Rev. 0**

Information furnished by Analog Devices is believed to be accurate and reliable. However, no responsibility is assumed by Analog Devices for its use, nor any infringements of patents or other rights of third parties that may result from its use. Specifications subject to change without notice. No license is granted by implication or otherwise under any patent or patent rights of Analog Devices. Trademarks and registered trademarks are the property of their respective owners.

## TABLE OF CONTENTS

Specifications—2.7 V to 3.6 V .....	3	Typical Performance Characteristics .....	8
Specifications—2.5 V $\pm$ 0.2 V .....	4	Terminology .....	11
Specifications—1.65 V to 1.95 .....	5	Test Circuits.....	12
Absolute Maximum Ratings.....	6	Outline Dimensions .....	13
ESD Caution.....	6	Ordering Guide .....	13
Pin Configuration and Function Descriptions.....	7		

## REVISION HISTORY

4/05—Revision 0: Initial Version

## SPECIFICATIONS—2.7 V TO 3.6 V<sup>1</sup>

$V_{DD} = 2.7\text{ V to }3.6\text{ V}$ ,  $GND = 0\text{ V}$ , unless otherwise noted.

**Table 2.**

Parameter	+25°C	−40°C to +85°C	−40°C to +125°C	Unit	Test Conditions/Comments
<b>ANALOG SWITCH</b>					
Analog Signal Range			0 V to $V_{DD}$	V	$V_{DD} = 2.7\text{ V}$
On Resistance ( $R_{ON}$ )	0.28			$\Omega$ typ	$V_{DD} = 2.7\text{ V}$ , $V_S = 0\text{ V to }V_{DD}$ , $I_{DS} = -100\text{ mA}$
	0.37	0.43	0.48	$\Omega$ max	Figure 18
On Resistance Flatness ( $R_{FLAT(ON)}$ )	0.025			$\Omega$ typ	$V_{DD} = 2.7\text{ V}$ , $V_S = 0\text{ V to }V_{DD}$ , $I_{DS} = -100\text{ mA}$
	0.034	0.044	0.052	$\Omega$ max	
<b>LEAKAGE CURRENTS</b>					
Source Off Leakage $I_S$ (OFF)	$\pm 0.2$			nA typ	$V_{DD} = 3.6\text{ V}$ $V_S = 0.6\text{ V}/3.3\text{ V}$ , $V_D = 3.3\text{ V}/0.6\text{ V}$ ; Figure 19
Channel On Leakage $I_D$ , $I_S$ (ON)	$\pm 0.2$			nA typ	$V_S = V_D = 0.6\text{ V or }3.3\text{ V}$ ; Figure 20
<b>DIGITAL INPUTS</b>					
Input High Voltage, $V_{INH}$			2	V min	
Input Low Voltage, $V_{INL}$			0.8	V max	
Input Current, $I_{INL}$ or $I_{INH}$	0.005			$\mu\text{A}$ typ	$V_{IN} = V_{INL}$ or $V_{INH}$
			$\pm 0.1$	$\mu\text{A}$ max	
Digital Input Capacitance, $C_{IN}$	3.2			pF typ	
<b>DYNAMIC CHARACTERISTICS<sup>2</sup></b>					
$t_{ON}$	10.5			ns typ	$R_L = 50\ \Omega$ , $C_L = 35\text{ pF}$
	14	15.5	16.5	ns max	$V_S = 1.5\text{ V}$ ; Figure 21
$t_{OFF}$	6.5			ns typ	$R_L = 50\ \Omega$ , $C_L = 35\text{ pF}$
	7.8	8	8.2	ns max	$V_S = 1.5\text{ V}$ ; Figure 21
Charge Injection	200			pC typ	$V_S = 1.5\text{ V}$ , $R_S = 0\ \Omega$ , $C_L = 1\text{ nF}$ ; Figure 22
Off Isolation	−54			dB typ	$R_L = 50\ \Omega$ , $C_L = 5\text{ pF}$ , $f = 100\text{ kHz}$ ; Figure 23
Total Harmonic Distortion (THD + N)	0.012			%	$R_L = 32\ \Omega$ , $f = 20\text{ Hz to }20\text{ kHz}$ , $V_S = 3\text{ V p-p}$
Insertion Loss	−0.02			dB typ	$R_L = 50\ \Omega$ , $C_L = 5\text{ pF}$ ; Figure 24
−3 dB Bandwidth	21			MHz typ	$R_L = 50\ \Omega$ , $C_L = 5\text{ pF}$ ; Figure 24
$C_S$ (OFF)	160			pF typ	
$C_D$ (OFF)	160			pF typ	
$C_D$ , $C_S$ (ON)	238			pF typ	
<b>POWER REQUIREMENTS</b>					
$I_{DD}$	0.003			$\mu\text{A}$ typ	$V_{DD} = 3.6\text{ V}$ Digital inputs = 0 V or 3.6 V
		1	4	$\mu\text{A}$ max	

<sup>1</sup> Temperature range is  $-40^\circ\text{C}$  to  $+125^\circ\text{C}$

<sup>2</sup> Guaranteed by design; not subject to production test.

# ADG841/ADG842

## SPECIFICATIONS—2.5 V ± 0.2 V<sup>1</sup>

V<sub>DD</sub> = 2.5 V ± 0.2 V, GND = 0 V, unless otherwise noted.

Table 3.

Parameter	+25°C	−40°C to +85°C	−40°C to +125°C	Unit	Test Conditions/Comments
<b>ANALOG SWITCH</b>					
Analog Signal Range			0 V to V <sub>DD</sub>	V	
On Resistance (R <sub>ON</sub> )	0.3			Ω typ	V <sub>DD</sub> = 2.3 V, V <sub>S</sub> = 0 V to V <sub>DD</sub> , I <sub>DS</sub> = −100 mA
	0.35	0.4	0.45	Ω max	Figure 18
On Resistance Flatness (R <sub>FLAT(ON)</sub> )	0.025			Ω typ	V <sub>DD</sub> = 2.3 V, V <sub>S</sub> = 0 V to V <sub>DD</sub> , I <sub>DS</sub> = −100 mA
	0.04	0.05	0.05	Ω max	
<b>LEAKAGE CURRENTS</b>					
Source Off Leakage I <sub>S</sub> (OFF)	±0.2			nA typ	V <sub>DD</sub> = 2.7 V
Channel On Leakage I <sub>D</sub> , I <sub>S</sub> (ON)	±0.2			nA typ	V <sub>S</sub> = 0.6 V/2.4 V, V <sub>D</sub> = 2.4 V/0.6 V; Figure 19
					V <sub>S</sub> = V <sub>D</sub> = 0.6 V or 2.4 V; Figure 20
<b>DIGITAL INPUTS</b>					
Input High Voltage, V <sub>INH</sub>			1.7	V min	
Input Low Voltage, V <sub>INL</sub>			0.7	V max	
Input Current, I <sub>INL</sub> or I <sub>INH</sub>	0.005			μA typ	V <sub>IN</sub> = V <sub>INL</sub> or V <sub>INH</sub>
			±0.1	μA max	
Digital Input Capacitance, C <sub>IN</sub>	3.2			pF typ	
<b>DYNAMIC CHARACTERISTICS<sup>2</sup></b>					
t <sub>ON</sub>	13			ns typ	R <sub>L</sub> = 50 Ω, C <sub>L</sub> = 35 pF
	16.5	18	19	ns max	V <sub>S</sub> = 1.5 V; Figure 21
t <sub>OFF</sub>	7			ns typ	R <sub>L</sub> = 50 Ω, C <sub>L</sub> = 35 pF
	8.2	8.4	8.6	ns max	V <sub>S</sub> = 1.5 V; Figure 21
Charge Injection	150			pC typ	V <sub>S</sub> = 1.25 V, R <sub>S</sub> = 0 Ω, C <sub>L</sub> = 1 nF; Figure 22
Off Isolation	−54			dB typ	R <sub>L</sub> = 50 Ω, C <sub>L</sub> = 5 pF, f = 100 kHz; Figure 23
Total Harmonic Distortion (THD + N)	0.022			%	R <sub>L</sub> = 32 Ω, f = 20 Hz to 20 kHz, V <sub>S</sub> = 1.5 V p-p
Insertion Loss	−0.02			dB typ	R <sub>L</sub> = 50 Ω, C <sub>L</sub> = 5 pF; Figure 24
−3 dB Bandwidth	21			MHz typ	R <sub>L</sub> = 50 Ω, C <sub>L</sub> = 5 pF; Figure 24
C <sub>S</sub> (OFF)	170			pF typ	
C <sub>D</sub> (OFF)	170			pF typ	
C <sub>D</sub> , C <sub>S</sub> (ON)	238			pF typ	
<b>POWER REQUIREMENTS</b>					
I <sub>DD</sub>	0.003			μA typ	V <sub>DD</sub> = 2.7 V
		1	4	μA max	Digital inputs = 0 V or 2.7 V

<sup>1</sup> Temperature range is −40°C to +125°C.

<sup>2</sup> Guaranteed by design; not subject to production test.

## SPECIFICATIONS—1.65 V TO 1.95<sup>1</sup>

$V_{DD}$  = 1.65 V to 1.95 V, GND = 0 V, unless otherwise noted.

Table 4.

Parameter	+25°C	-40°C to +85°C	-40°C to +125°C	Unit	Test Conditions/Comments
<b>ANALOG SWITCH</b>					
Analog Signal Range			0 V to $V_{DD}$	V	
On Resistance ( $R_{ON}$ )	0.37			$\Omega$ typ	$V_{DD} = 1.8$ V, $V_S = 0$ V to $V_{DD}$ , $I_{DS} = -100$ mA
	0.4	0.84	0.84	$\Omega$ max	Figure 18
	0.6	1.8	1.8	$\Omega$ max	$V_{DD} = 1.65$ V, $V_S = 0$ V to $V_{DD}$ , $I_{DS} = -100$ mA
On Resistance Flatness ( $R_{FLAT(ON)}$ )	0.17			$\Omega$ typ	$V_{DD} = 1.65$ V, $V_S = 0$ V to $V_{DD}$ , $I_{DS} = -100$ mA
<b>LEAKAGE CURRENTS</b>					
Source Off Leakage $I_S$ (OFF)	$\pm 0.2$			nA typ	$V_{DD} = 1.95$ V
Channel On Leakage $I_D$ , $I_S$ (ON)	$\pm 0.2$			nA typ	$V_S = 0.6$ V/1.65 V, $V_D = 1.65$ V/0.6 V; Figure 19
					$V_S = V_D = 0.6$ V or 1.65 V; Figure 20
<b>DIGITAL INPUTS</b>					
Input High Voltage, $V_{INH}$			$0.65 V_{DD}$	V min	
Input Low Voltage, $V_{INL}$			$0.35 V_{DD}$	V max	
Input Current, $I_{INL}$ or $I_{INH}$	0.005			$\mu$ A typ	$V_{IN} = V_{INL}$ or $V_{INH}$
			$\pm 0.1$	$\mu$ A max	
Digital Input Capacitance, $C_{IN}$	4			pF typ	
<b>DYNAMIC CHARACTERISTICS<sup>2</sup></b>					
$t_{ON}$	19			ns typ	$R_L = 50$ $\Omega$ , $C_L = 35$ pF
	26	28	30	ns max	$V_S = 1.5$ V; Figure 21
$t_{OFF}$	8			ns typ	$R_L = 50$ $\Omega$ , $C_L = 35$ pF
	9.5	9.8	10	ns max	$V_S = 1.5$ V; Figure 21
Charge Injection	100			pC typ	$V_S = 1$ V, $R_S = 0$ V, $C_L = 1$ nF; Figure 22
Off Isolation	-54			dB typ	$R_L = 50$ $\Omega$ , $C_L = 5$ pF, $f = 100$ kHz; Figure 23
Total Harmonic Distortion (THD + N)	0.14			%	$R_L = 32$ $\Omega$ , $f = 20$ Hz to 20 kHz, $V_S = 1.2$ V p-p
Insertion Loss	-0.02			dB typ	$R_L = 50$ $\Omega$ , $C_L = 5$ pF; Figure 24
-3 dB Bandwidth	21			MHz typ	$R_L = 50$ $\Omega$ , $C_L = 5$ pF; Figure 24
$C_S$ (OFF)	178			pF typ	
$C_D$ (OFF)	178			pF typ	
$C_D$ , $C_S$ (ON)	238			pF typ	
<b>POWER REQUIREMENTS</b>					
$I_{DD}$	0.003			$\mu$ A typ	$V_{DD} = 1.95$ V
		1	4	$\mu$ A max	Digital inputs = 0 V or 1.95 V

<sup>1</sup> Temperature range -40°C to +125°C.

<sup>2</sup> Guaranteed by design; not subject to production test.

## ABSOLUTE MAXIMUM RATINGS

T<sub>A</sub> = 25°C, unless otherwise noted.

Table 5.

Parameter	Rating
V <sub>DD</sub> to GND	−0.3 V to +4.6 V
Analog Inputs <sup>1</sup>	−0.3 V to V <sub>DD</sub> + 0.3 V
Digital Inputs <sup>1</sup>	−0.3 V to 4.6 V or 10 mA, whichever occurs first
Peak Current, S or D	
3.3 V Operation	500 mA
2.5 V Operation	460 mA
1.8 V Operation	420 mA (pulsed at 1 ms, 10% duty cycle max)
Continuous Current, S or D	
3.3 V Operation	300 mA
2.5 V Operation	275 mA
1.8 V Operation	250 mA
Operating Temperature Range	
Automotive (Y Version)	−40°C to +125°C
Storage Temperature Range	−65°C to +150°C
Junction Temperature	150°C
SC70 Package	
θ <sub>JA</sub> Thermal Impedance	494.8°C/W
Reflow Soldering (Pb-free)	
Peak Temperature	260(+0/−5)°C
Time at Peak Temperature	10 sec to 40 sec

<sup>1</sup> Overvoltages at S or D are clamped by internal diodes. Current should be limited to the maximum ratings given.

Stresses above those listed under Absolute Maximum Ratings may cause permanent damage to the device. This is a stress rating only; functional operation of the device at these or any other conditions above those indicated in the operational section of this specification is not implied. Exposure to absolute maximum rating conditions for extended periods may affect device reliability. Only one absolute maximum rating may be applied at any one time.

### ESD CAUTION

ESD (electrostatic discharge) sensitive device. Electrostatic charges as high as 4000 V readily accumulate on the human body and test equipment and can discharge without detection. Although this product features proprietary ESD protection circuitry, permanent damage may occur on devices subjected to high energy electrostatic discharges. Therefore, proper ESD precautions are recommended to avoid performance degradation or loss of functionality.



## PIN CONFIGURATION AND FUNCTION DESCRIPTIONS

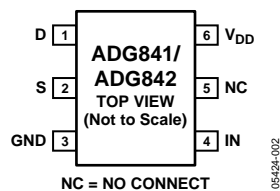

Figure 2. 6-Lead SC70

Table 6. Pin Function Descriptions

Pin No.	Mnemonic	Description
1	D	Drain Terminal. Can be an input or output.
2	S	Source Terminal. Can be an input or output.
3	GND	Ground (0 V) Reference.
4	IN	Logic Control Input.
5	NC	No Connect.
6	V <sub>DD</sub>	Most Positive Power Supply Potential.

## TYPICAL PERFORMANCE CHARACTERISTICS

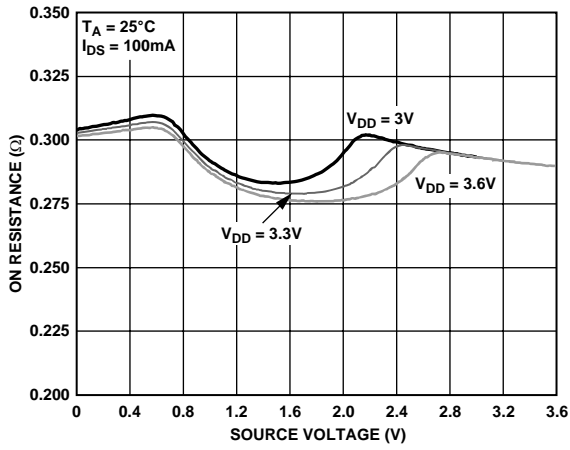

Figure 3. On Resistance vs.  $V_D$  (Vs)  $V_{DD} = 3.3\text{ V} \pm 0.3\text{ V}$

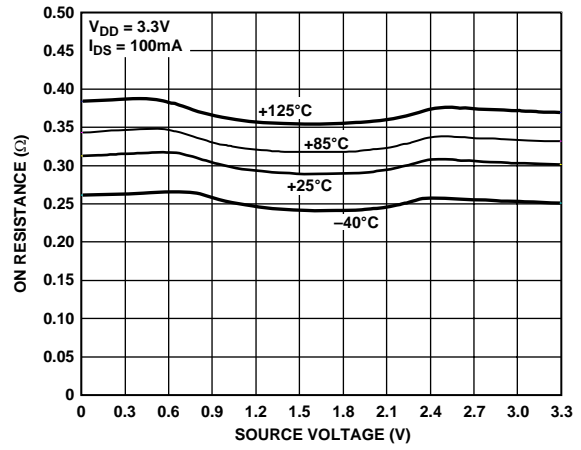

Figure 6. On Resistance vs.  $V_D$  (Vs) for Different Temperatures,  $V_{DD} = 3.3\text{ V}$

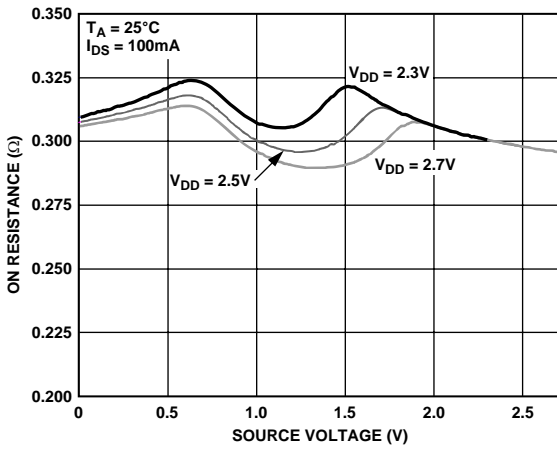

Figure 4. On Resistance vs.  $V_D$  (Vs)  $V_{DD} = 2.5\text{ V} \pm 0.2\text{ V}$

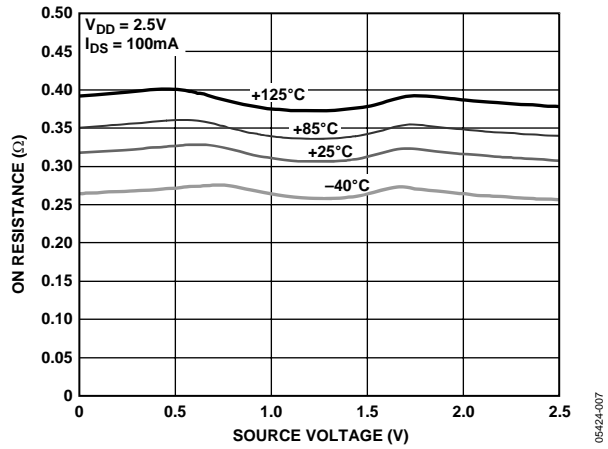

Figure 7. On Resistance vs.  $V_D$  (Vs) for Different Temperatures,  $V_{DD} = 2.5\text{ V}$

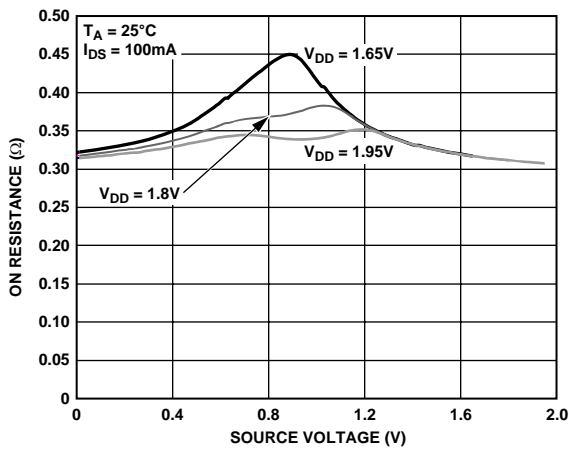

Figure 5. On Resistance vs.  $V_D$  (Vs)  $V_{DD} = 1.8\text{ V} \pm 0.15\text{ V}$

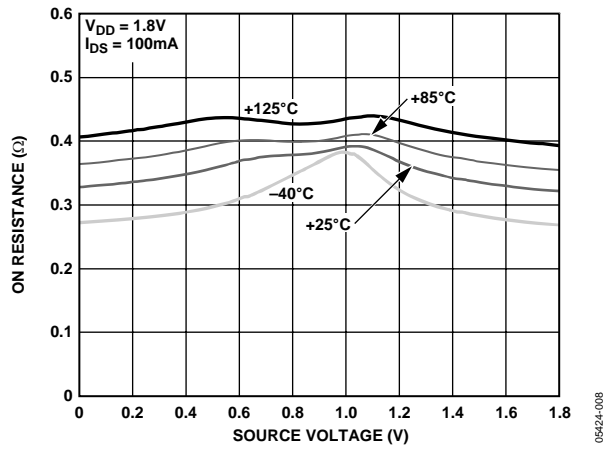

Figure 8. On Resistance vs.  $V_D$  (Vs) for Different Temperatures,  $V_{DD} = 1.8\text{ V}$



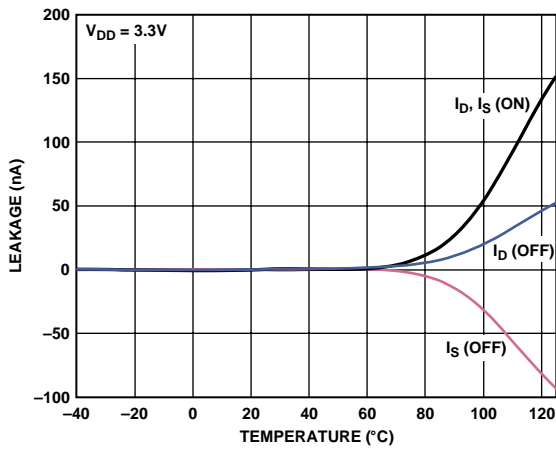

Figure 9. Leakage Current vs. Temperature,  $V_{DD} = 3.3V$

05424-009

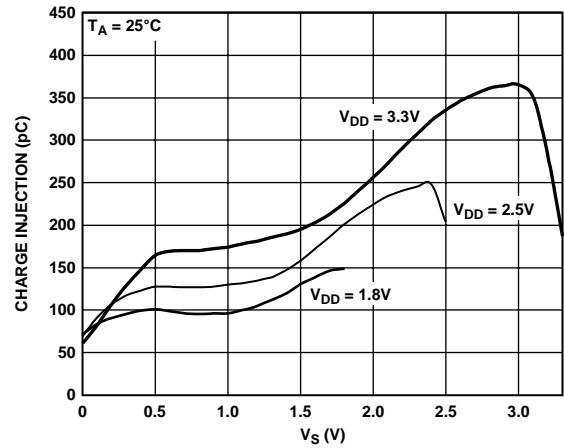

Figure 12. Charge Injection vs. Source Voltage

05424-012

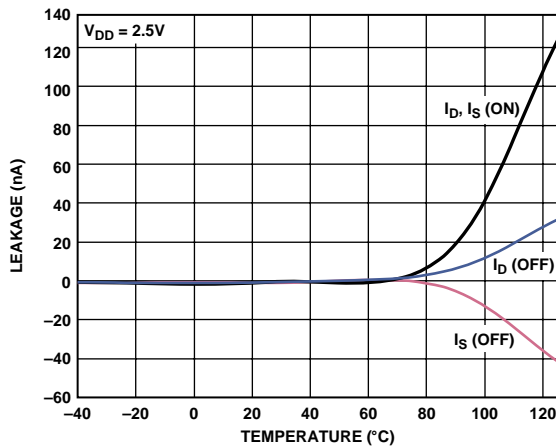

Figure 10. Leakage Current vs. Temperature,  $V_{DD} = 2.5V$

05424-010

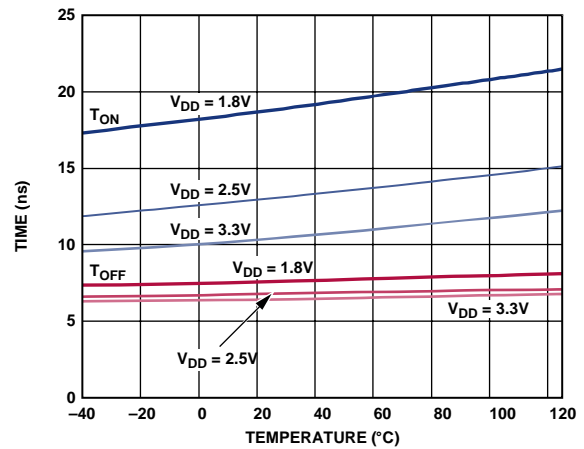

Figure 13.  $t_{ON}/t_{OFF}$  Times vs. Temperature

05424-013

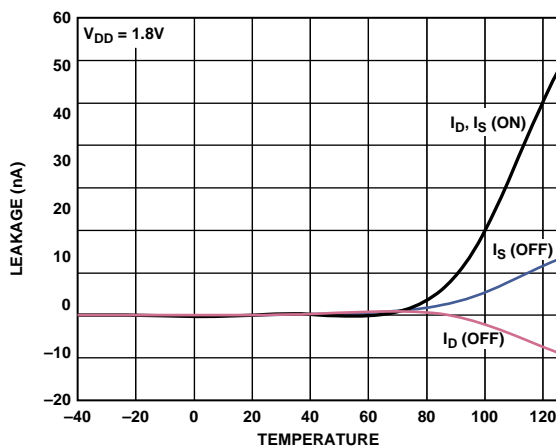

Figure 11. Leakage Current vs. Temperature,  $V_{DD} = 1.8V$

05424-011

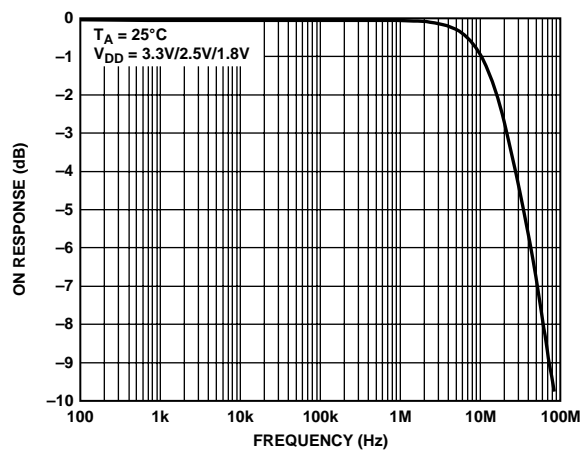

Figure 14. Bandwidth

05424-014

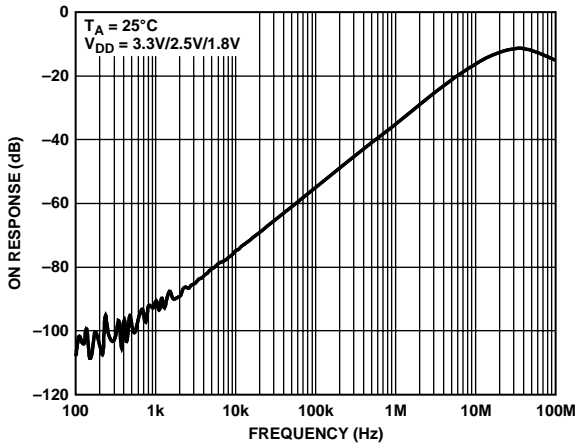

Figure 15. Off Isolation vs. Frequency

05424-015

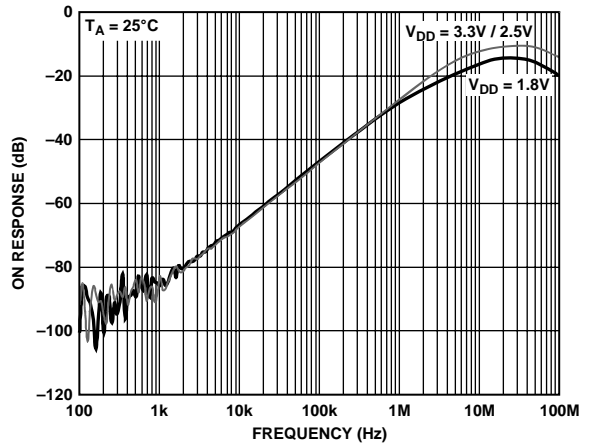

Figure 17. AC PSRR

05424-017

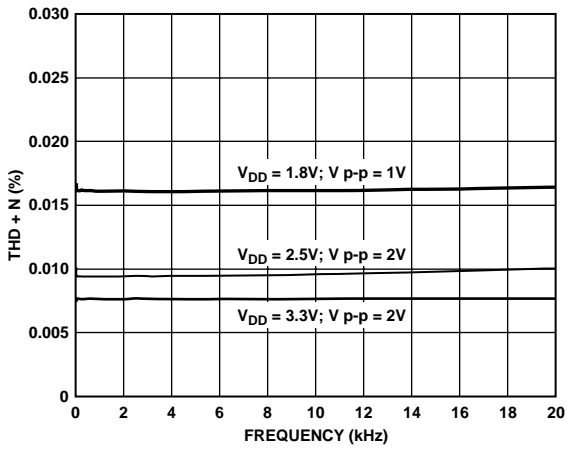

Figure 16. Total Harmonic Distortion + Noise

05424-016

## TERMINOLOGY

### $I_{DD}$

Positive supply current.

### $V_D$ ( $V_S$ )

Analog voltage on Terminals D and S.

### $R_{ON}$

Ohmic resistance between D and S.

### $R_{FLAT}$ (ON)

Flatness is the difference between the maximum and minimum value of on resistance as measured over the specified analog signal range.

### $I_S$ (OFF)

Source leakage current with the switch off.

### $I_D$ (OFF)

Drain leakage current with the switch off.

### $I_D, I_S$ (ON)

Channel leakage current with the switch on.

### $V_{INL}$

Maximum input voltage for Logic 0.

### $V_{INH}$

Minimum input voltage for Logic 1.

### $I_{INL}$ ( $I_{INH}$ )

Input current of the digital input.

### $C_S$ (OFF)

Off switch source capacitance. Measured with reference to ground.

### $C_D$ (OFF)

Off switch drain capacitance. Measured with reference to ground.

### $C_D, C_S$ (ON)

On switch capacitance. Measured with reference to ground.

### $C_{IN}$

Digital input capacitance.

### $t_{ON}$

Delay time between the 50% and the 90% points of the digital input and switch on condition.

### $t_{OFF}$

Delay time between the 50% and the 90% points of the digital input and switch off condition.

### Charge Injection

A measure of the glitch impulse transferred from the digital input to the analog output during on-off switching.

### Off Isolation

A measure of unwanted signal coupling through an off switch.

### -3 dB Bandwidth

The frequency at which the output is attenuated by 3 dB.

### On Response

The frequency response of the on switch.

### Insertion Loss

The loss due to the on resistance of the switch.

### THD + N

The ratio of the harmonics amplitude plus noise of a signal to the fundamental.

### PSRR

Power Supply Rejection Ratio. This is a measure of the coupling of unwanted ac signals on the power supply to the switch output when the supply is not decoupled.

## TEST CIRCUITS

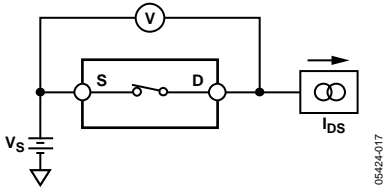

Figure 18. On Resistance

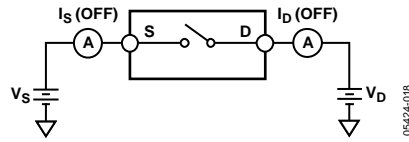

Figure 19. Off Leakage

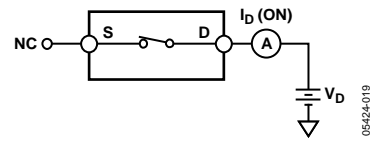

Figure 20. On Leakage

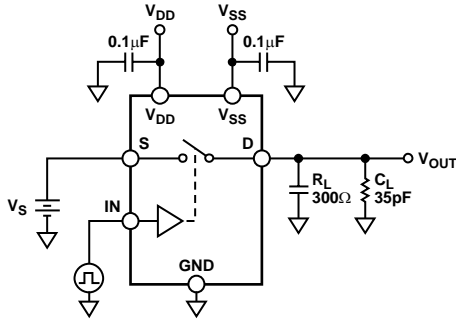

Figure 21. Switching Times,  $t_{ON}$ ,  $t_{OFF}$

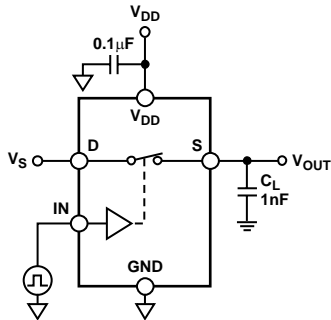
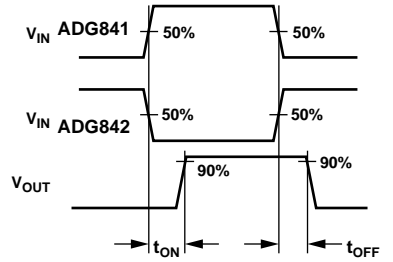

Figure 22. Charge Injection

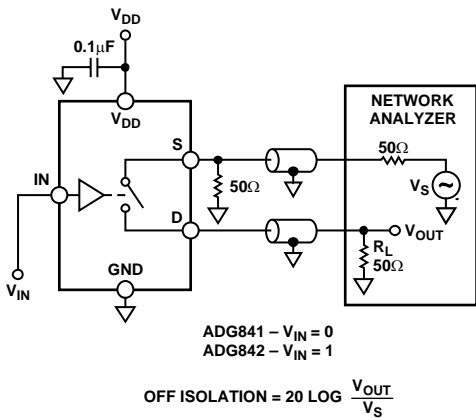
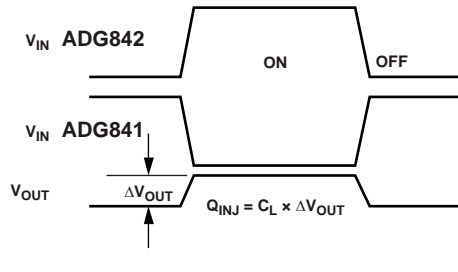

Figure 23. Off Isolation

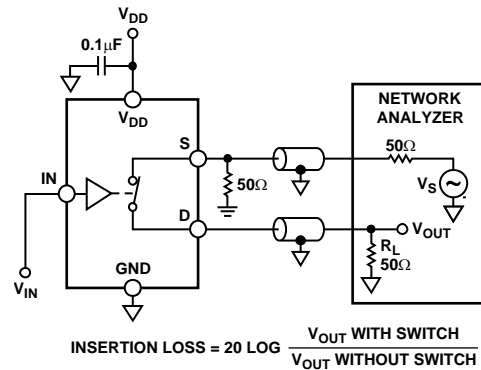
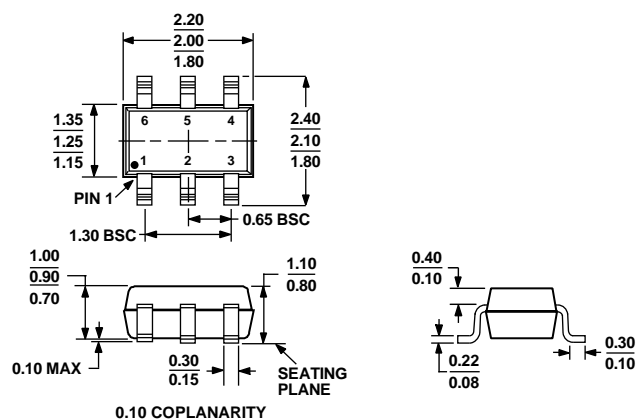

Figure 24. Bandwidth

## OUTLINE DIMENSIONS



COMPLIANT TO JEDEC STANDARDS MO-203-AB

Figure 25. 6-Lead Thin Shrink Small Outline Transistor [SC70]  
(KS-6)

Dimensions shown in millimeters

## ORDERING GUIDE

Model	Temperature Range	Package Description	Package Option	Branding <sup>1</sup>
ADG841YKSZ-500RL7 <sup>2</sup>	-40°C to +125°C	6-Lead Thin Shrink Small Outline Transistor (SC70)	KS-6	SVA
ADG841YKSZ-REEL <sup>2</sup>	-40°C to +125°C	6-Lead Thin Shrink Small Outline Transistor (SC70)	KS-6	SVA
ADG841YKSZ-REEL7 <sup>2</sup>	-40°C to +125°C	6-Lead Thin Shrink Small Outline Transistor (SC70)	KS-6	SVA
ADG842YKSZ-500RL7 <sup>2</sup>	-40°C to +125°C	6-Lead Thin Shrink Small Outline Transistor (SC70)	KS-6	SWA
ADG842YKSZ-REEL <sup>2</sup>	-40°C to +125°C	6-Lead Thin Shrink Small Outline Transistor (SC70)	KS-6	SWA
ADG842YKSZ-REEL7 <sup>2</sup>	-40°C to +125°C	6-Lead Thin Shrink Small Outline Transistor (SC70)	KS-6	SWA

<sup>1</sup> Branding on this package is limited to three characters due to space constraints.

<sup>2</sup> Z = Pb-free part.

**NOTES**

**NOTES**

**NOTES**



# Mouser Electronics

Authorized Distributor

Click to View Pricing, Inventory, Delivery & Lifecycle Information:

[Analog Devices Inc.:](#)

[ADG841YKSZ-REEL7](#) [ADG841YKSZ-500RL7](#) [EVAL-6SC70EBZ](#)