

MMBT3904L, SMMBT3904L

General Purpose Transistor

NPN Silicon

Features

- These Devices are Pb-Free, Halogen Free/BFR Free and are RoHS Compliant
- S Prefix for Automotive and Other Applications Requiring Unique Site and Control Change Requirements; AEC-Q101 Qualified and PPAP Capable

MAXIMUM RATINGS

Rating	Symbol	Value	Unit
Collector-Emitter Voltage	V_{CEO}	40	Vdc
Collector-Base Voltage	V_{CBO}	60	Vdc
Emitter-Base Voltage	V_{EBO}	6.0	Vdc
Collector Current - Continuous	I_C	200	mAdc
Collector Current - Peak (Note 3)	I_{CM}	900	mAdc

THERMAL CHARACTERISTICS

Characteristic	Symbol	Max	Unit
Total Device Dissipation FR-5 Board (Note 1) @ $T_A = 25^\circ\text{C}$ Derate above 25°C	P_D	225 1.8	mW mW/ $^\circ\text{C}$
Thermal Resistance, Junction-to-Ambient	$R_{\theta JA}$	556	$^\circ\text{C}/\text{W}$
Total Device Dissipation Alumina Substrate, (Note 2) @ $T_A = 25^\circ\text{C}$ Derate above 25°C	P_D	300 2.4	mW mW/ $^\circ\text{C}$
Thermal Resistance, Junction-to-Ambient	$R_{\theta JA}$	417	$^\circ\text{C}/\text{W}$
Junction and Storage Temperature	T_J, T_{stg}	-55 to +150	$^\circ\text{C}$

Stresses exceeding those listed in the Maximum Ratings table may damage the device. If any of these limits are exceeded, device functionality should not be assumed, damage may occur and reliability may be affected.

1. FR-5 = $1.0 \times 0.75 \times 0.062$ in.
2. Alumina = $0.4 \times 0.3 \times 0.024$ in. 99.5% alumina.
3. Reference SOA curve.



ON Semiconductor®

www.onsemi.com

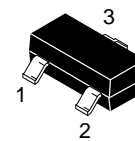
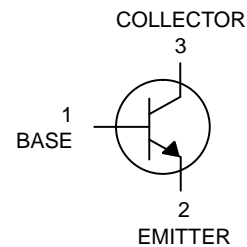

SOT-23 (TO-236)
CASE 318
STYLE 6

MARKING DIAGRAM

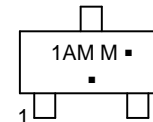

1AM = Specific Device Code
M = Date Code*
■ = Pb-Free Package

(Note: Microdot may be in either location)

*Date Code orientation and/or overbar may vary depending upon manufacturing location.

ORDERING INFORMATION

Device	Package	Shipping†
MMBT3904LT1G SMMBT3904LT1G	SOT-23 (Pb-Free)	3000 / Tape & Reel
MMBT3904LT3G SMMBT3904LT3G	SOT-23 (Pb-Free)	10,000 / Tape & Reel

†For information on tape and reel specifications, including part orientation and tape sizes, please refer to our Tape and Reel Packaging Specifications Brochure, BRD8011/D.

MMBT3904L, SMMBT3904L

ELECTRICAL CHARACTERISTICS (T_A = 25°C unless otherwise noted)

Characteristic	Symbol	Min	Max	Unit
OFF CHARACTERISTICS				
Collector-Emitter Breakdown Voltage (I _C = 1.0 mA, I _B = 0)	V _{(BR)CEO}	40	-	Vdc
Collector-Base Breakdown Voltage (I _C = 10 μA, I _E = 0)	V _{(BR)CBO}	60	-	Vdc
Emitter-Base Breakdown Voltage (I _E = 10 μA, I _C = 0)	V _{(BR)EBO}	6.0	-	Vdc
Base Cutoff Current (V _{CE} = 30 Vdc, V _{EB} = 3.0 Vdc)	I _{BL}	-	50	nAdc
Collector Cutoff Current (V _{CE} = 30 Vdc, V _{EB} = 3.0 Vdc)	I _{CEx}	-	50	nAdc

ON CHARACTERISTICS (Note 4)

DC Current Gain (I _C = 0.1 mA, V _{CE} = 1.0 Vdc) (I _C = 1.0 mA, V _{CE} = 1.0 Vdc) (I _C = 10 mA, V _{CE} = 1.0 Vdc) (I _C = 50 mA, V _{CE} = 1.0 Vdc) (I _C = 100 mA, V _{CE} = 1.0 Vdc)	H _{FE}	40 70 100 60 30	- - 300 - -	-
Collector-Emitter Saturation Voltage (I _C = 10 mA, I _B = 1.0 mA) (I _C = 50 mA, I _B = 5.0 mA)	V _{CE(sat)}	- -	0.2 0.3	Vdc
Base-Emitter Saturation Voltage (I _C = 10 mA, I _B = 1.0 mA) (I _C = 50 mA, I _B = 5.0 mA)	V _{BE(sat)}	0.65 -	0.85 0.95	Vdc

SMALL-SIGNAL CHARACTERISTICS

Current-Gain - Bandwidth Product (I _C = 10 mA, V _{CE} = 20 Vdc, f = 100 MHz)	f _T	300	-	MHz
Output Capacitance (V _{CB} = 5.0 Vdc, I _E = 0, f = 1.0 MHz)	C _{obo}	-	4.0	pF
Input Capacitance (V _{EB} = 0.5 Vdc, I _C = 0, f = 1.0 MHz)	C _{ibo}	-	8.0	pF
Input Impedance (V _{CE} = 10 Vdc, I _C = 1.0 mA, f = 1.0 kHz)	h _{ie}	1.0	10	kΩ
Voltage Feedback Ratio (V _{CE} = 10 Vdc, I _C = 1.0 mA, f = 1.0 kHz)	h _{re}	0.5	8.0	X 10 ⁻⁴
Small-Signal Current Gain (V _{CE} = 10 Vdc, I _C = 1.0 mA, f = 1.0 kHz)	h _{fe}	100	400	-
Output Admittance (V _{CE} = 10 Vdc, I _C = 1.0 mA, f = 1.0 kHz)	h _{oe}	1.0	40	μmhos
Noise Figure (V _{CE} = 5.0 Vdc, I _C = 100 μA, R _S = 1.0 k ohms, f = 1.0 kHz)	NF	-	5.0	dB

SWITCHING CHARACTERISTICS

Delay Time	(V _{CC} = 3.0 Vdc, V _{BE} = -0.5 Vdc, I _C = 10 mA, I _{B1} = 1.0 mA)	t _d	-	35	ns
Rise Time		t _r	-	35	
Storage Time	(V _{CC} = 3.0 Vdc, I _C = 10 mA, I _{B1} = I _{B2} = 1.0 mA)	t _s	-	200	ns
Fall Time		t _f	-	50	

Product parametric performance is indicated in the Electrical Characteristics for the listed test conditions, unless otherwise noted. Product performance may not be indicated by the Electrical Characteristics if operated under different conditions.

4. Pulse Test: Pulse Width ≤ 300 μs, Duty Cycle ≤ 2.0%.

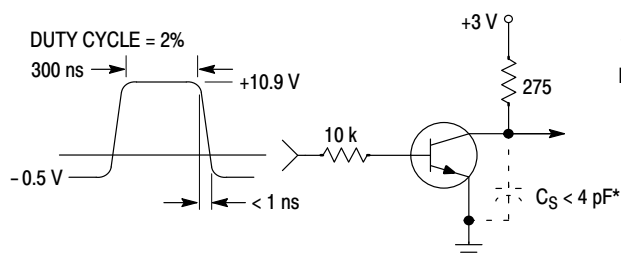

Figure 1. Delay and Rise Time Equivalent Test Circuit

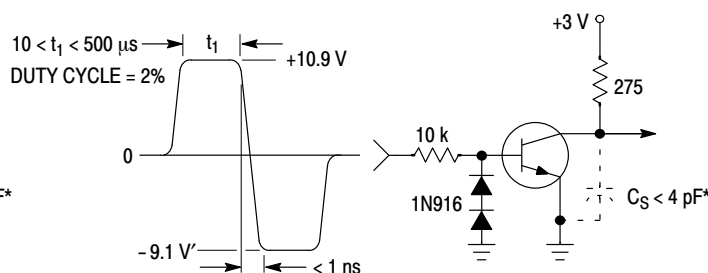

Figure 2. Storage and Fall Time Equivalent Test Circuit

* Total shunt capacitance of test jig and connectors

MMBT3904L, SMMBT3904L

TYPICAL TRANSIENT CHARACTERISTICS

— $T_J = 25^\circ\text{C}$
 - - - $T_J = 125^\circ\text{C}$

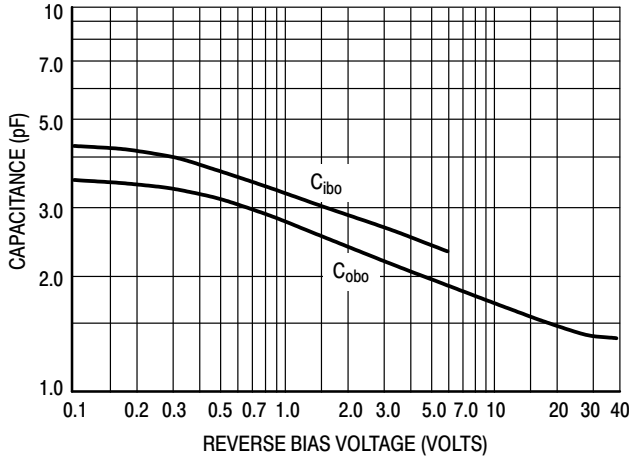

Figure 3. Capacitance

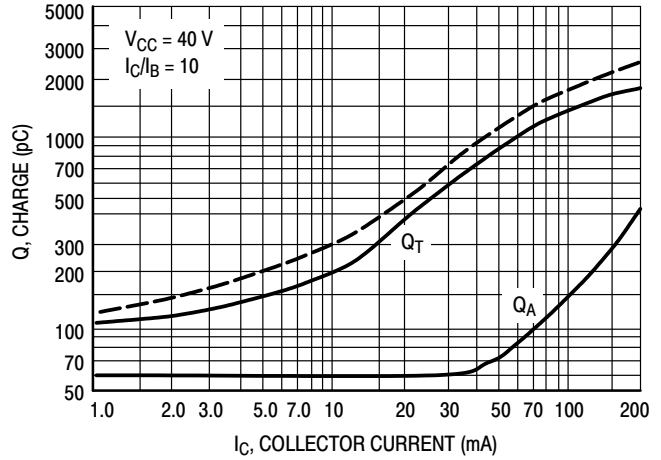

Figure 4. Charge Data

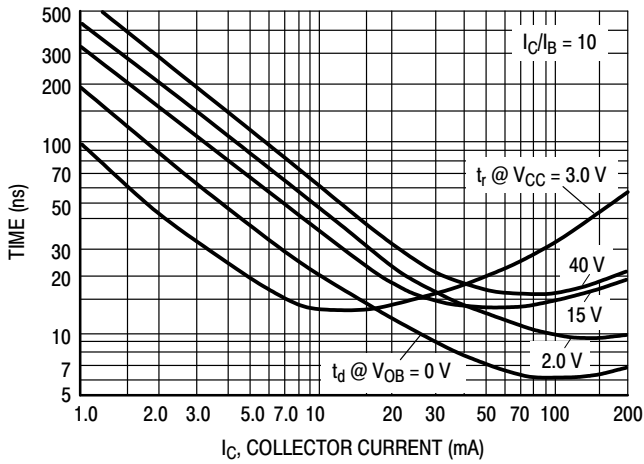

Figure 5. Turn-On Time

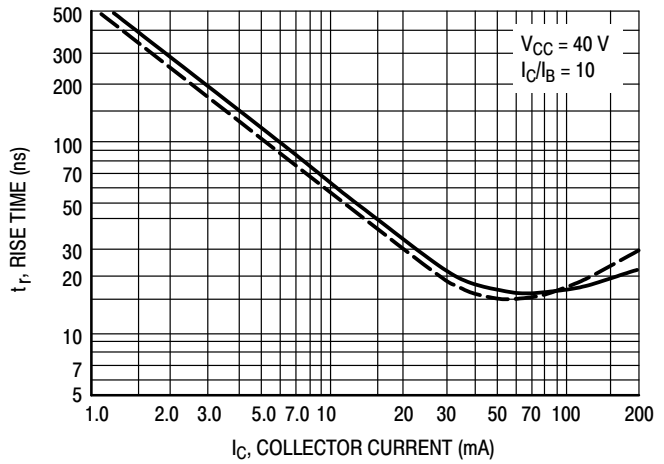

Figure 6. Rise Time

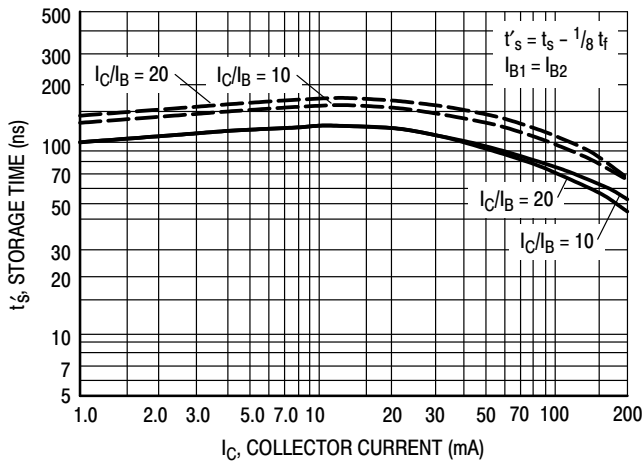

Figure 7. Storage Time

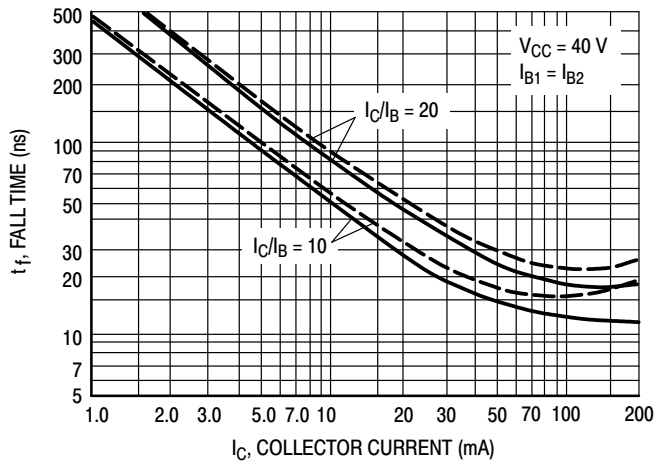

Figure 8. Fall Time

MMBT3904L, SMMBT3904L

TYPICAL AUDIO SMALL-SIGNAL CHARACTERISTICS NOISE FIGURE VARIATIONS

($V_{CE} = 5.0$ Vdc, $T_A = 25^\circ\text{C}$, Bandwidth = 1.0 Hz)

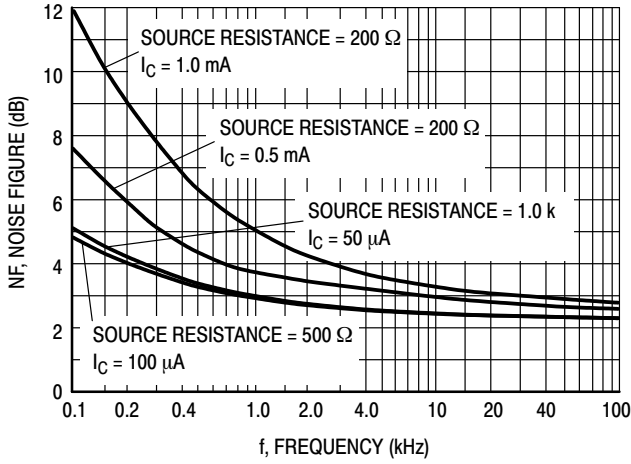

Figure 9.

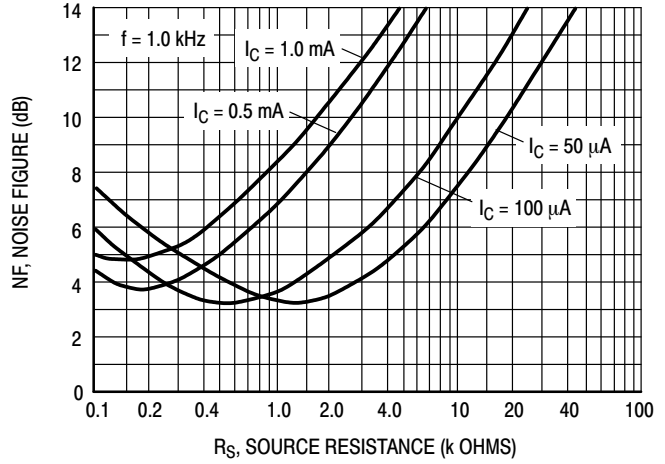

Figure 10.

h PARAMETERS

($V_{CE} = 10$ Vdc, $f = 1.0$ kHz, $T_A = 25^\circ\text{C}$)

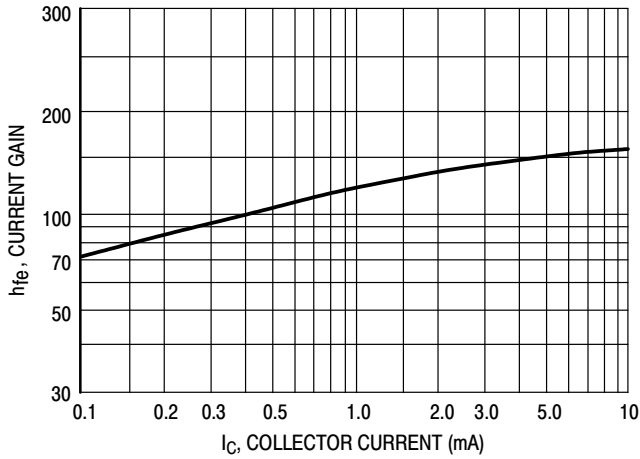

Figure 11. Current Gain

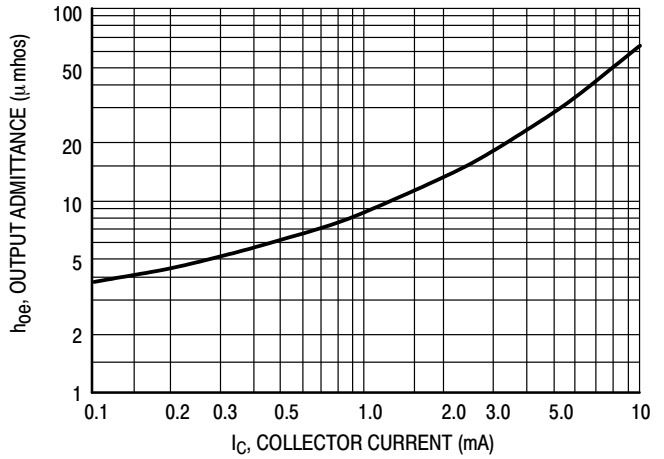

Figure 12. Output Admittance

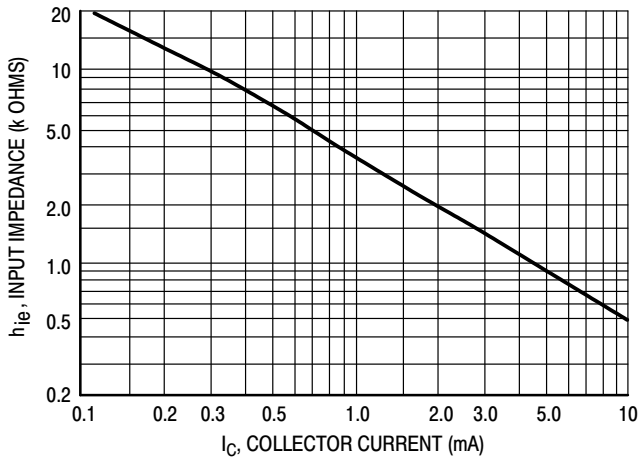

Figure 13. Input Impedance

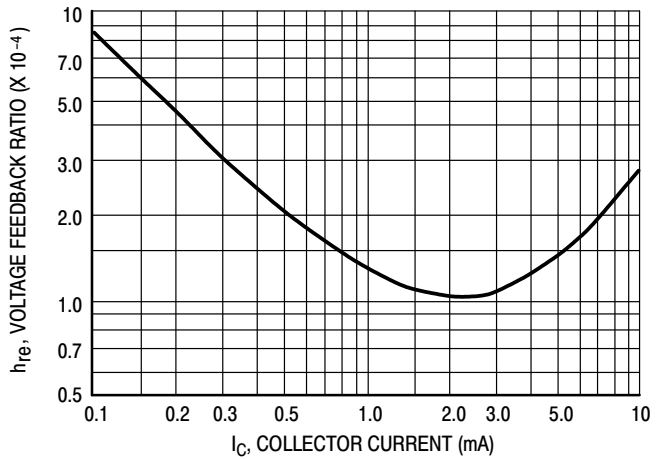

Figure 14. Voltage Feedback Ratio

MMBT3904L, SMMBT3904L

TYPICAL STATIC CHARACTERISTICS

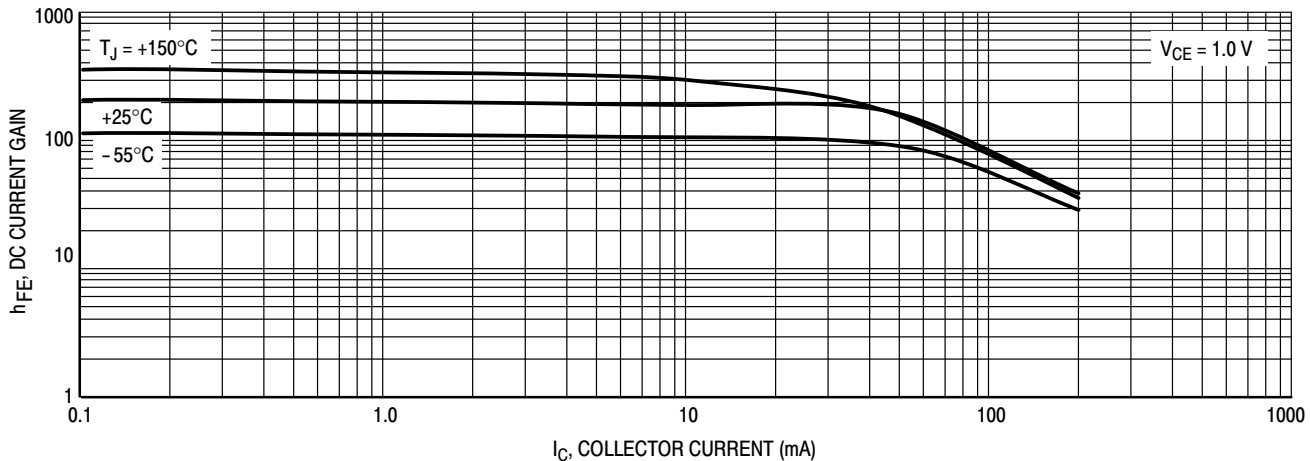

Figure 15. DC Current Gain

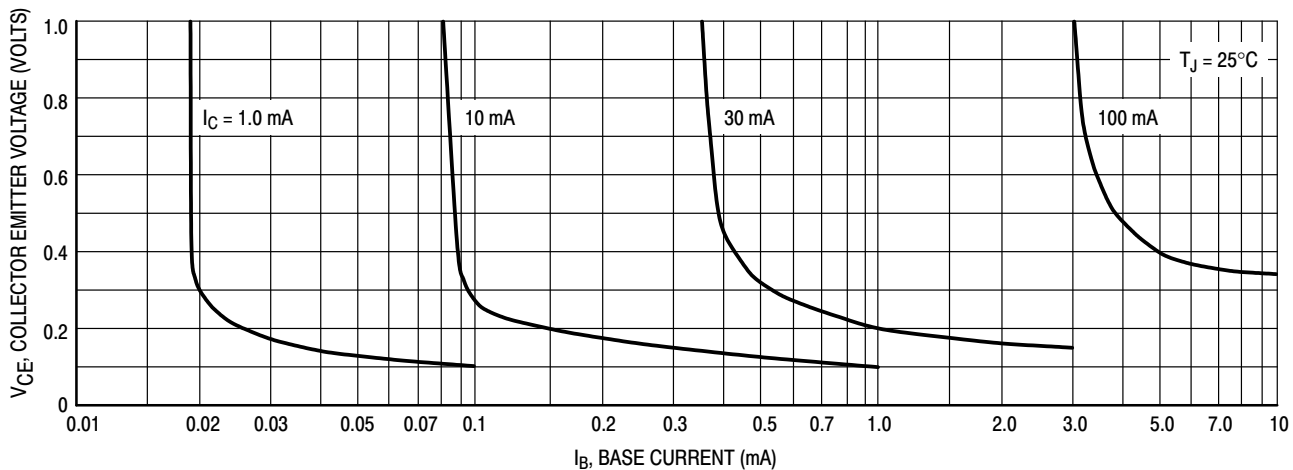

Figure 16. Collector Saturation Region

MMBT3904L, SMMBT3904L

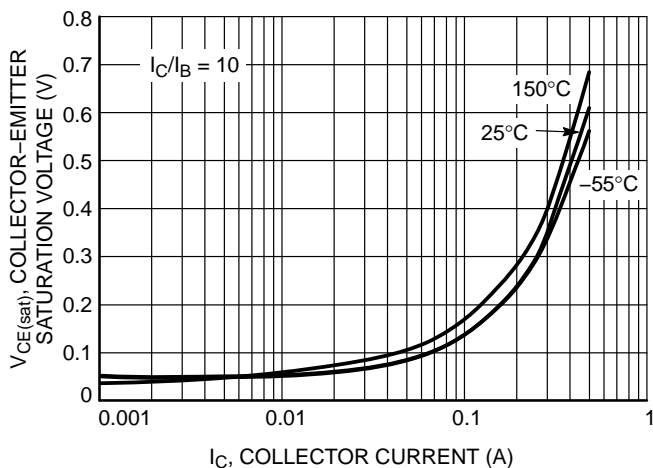

Figure 17. Collector Emitter Saturation Voltage vs. Collector Current

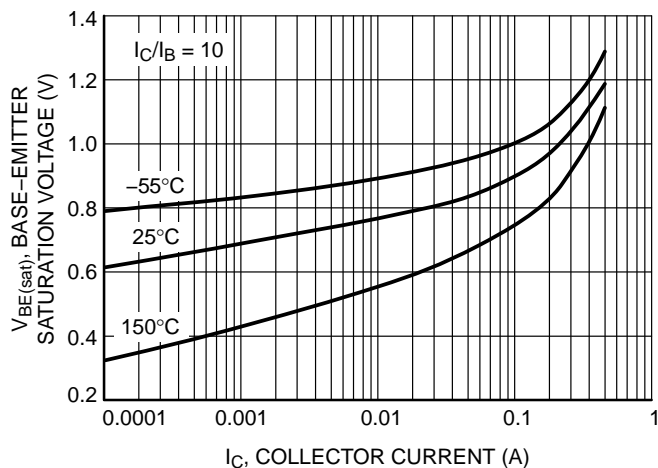

Figure 18. Base Emitter Saturation Voltage vs. Collector Current

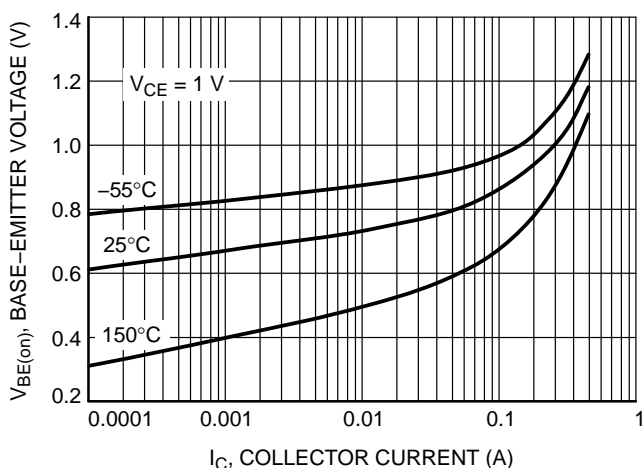

Figure 19. Base Emitter Voltage vs. Collector Current

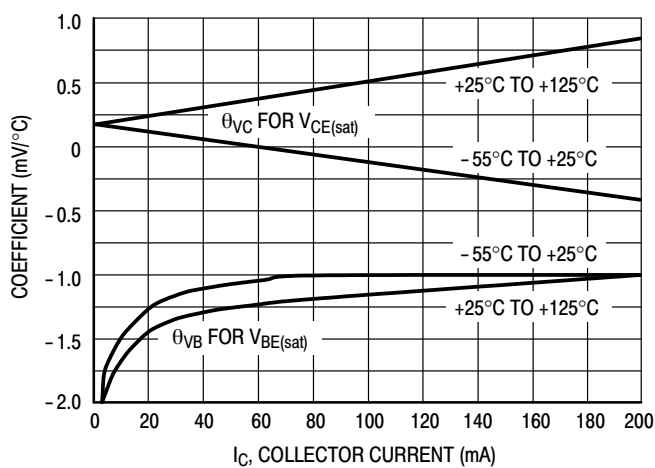

Figure 20. Temperature Coefficients

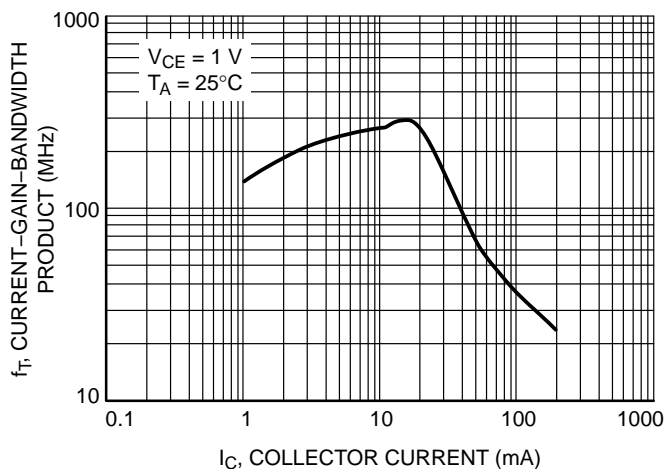

Figure 21. Current Gain Bandwidth vs. Collector Current

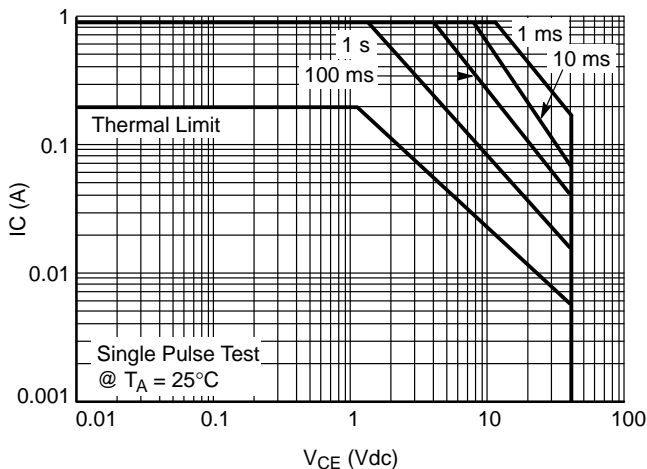

Figure 22. Safe Operating Area

MMBT3904L, SMMBT3904L

PACKAGE DIMENSIONS

SOT-23 (TO-236)

CASE 318-08

ISSUE AR

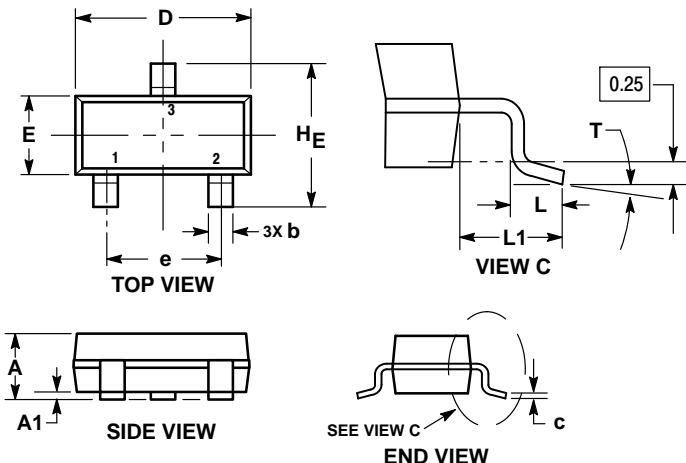

NOTES:

1. DIMENSIONING AND TOLERANCING PER ASME Y14.5M, 1994.
2. CONTROLLING DIMENSION: MILLIMETERS.
3. MAXIMUM LEAD THICKNESS INCLUDES LEAD FINISH. MINIMUM LEAD THICKNESS IS THE MINIMUM THICKNESS OF THE BASE MATERIAL.
4. DIMENSIONS D AND E DO NOT INCLUDE MOLD FLASH, PROTRUSIONS, OR GATE BURRS.

DIM	MILLIMETERS			INCHES		
	MIN	NOM	MAX	MIN	NOM	MAX
A	0.89	1.00	1.11	0.035	0.039	0.044
A1	0.01	0.06	0.10	0.000	0.002	0.004
b	0.37	0.44	0.50	0.015	0.017	0.020
c	0.08	0.14	0.20	0.003	0.006	0.008
D	2.80	2.90	3.04	0.110	0.114	0.120
E	1.20	1.30	1.40	0.047	0.051	0.055
e	1.78	1.90	2.04	0.070	0.075	0.080
L	0.30	0.43	0.55	0.012	0.017	0.022
L1	0.35	0.54	0.69	0.014	0.021	0.027
HE	2.10	2.40	2.64	0.083	0.094	0.104
T	0°	---	10°	0°	---	10°

STYLE 6:

1. BASE
2. EMITTER
3. COLLECTOR

RECOMMENDED SOLDERING FOOTPRINT*

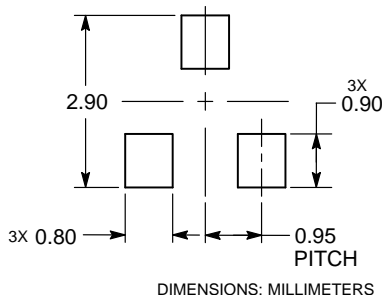

*For additional information on our Pb-Free strategy and soldering details, please download the ON Semiconductor Soldering and Mounting Techniques Reference Manual, SOLDERRM/D.

ON Semiconductor and are trademarks of Semiconductor Components Industries, LLC dba ON Semiconductor or its subsidiaries in the United States and/or other countries. ON Semiconductor owns the rights to a number of patents, trademarks, copyrights, trade secrets, and other intellectual property. A listing of ON Semiconductor's product/patent coverage may be accessed at www.onsemi.com/site/pdf/Patent-Marking.pdf. ON Semiconductor reserves the right to make changes without further notice to any products herein. ON Semiconductor makes no warranty, representation or guarantee regarding the suitability of its products for any particular purpose, nor does ON Semiconductor assume any liability arising out of the application or use of any product or circuit, and specifically disclaims any and all liability, including without limitation special, consequential or incidental damages. Buyer is responsible for its products and applications using ON Semiconductor products, including compliance with all laws, regulations and safety requirements or standards, regardless of any support or applications information provided by ON Semiconductor. "Typical" parameters which may be provided in ON Semiconductor data sheets and/or specifications can and do vary in different applications and actual performance may vary over time. All operating parameters, including "Typicals" must be validated for each customer application by customer's technical experts. ON Semiconductor does not convey any license under its patent rights nor the rights of others. ON Semiconductor products are not designed, intended, or authorized for use as a critical component in life support systems or any FDA Class 3 medical devices or medical devices with a same or similar classification in a foreign jurisdiction or any devices intended for implantation in the human body. Should Buyer purchase or use ON Semiconductor products for any such unintended or unauthorized application, Buyer shall indemnify and hold ON Semiconductor and its officers, employees, subsidiaries, affiliates, and distributors harmless against all claims, costs, damages, and expenses, and reasonable attorney fees arising out of, directly or indirectly, any claim of personal injury or death associated with such unintended or unauthorized use, even if such claim alleges that ON Semiconductor was negligent regarding the design or manufacture of the part. ON Semiconductor is an Equal Opportunity/Affirmative Action Employer. This literature is subject to all applicable copyright laws and is not for resale in any manner.

PUBLICATION ORDERING INFORMATION

LITERATURE FULFILLMENT:
 Literature Distribution Center for ON Semiconductor
 19521 E. 32nd Pkwy, Aurora, Colorado 80011 USA
Phone: 303-675-2175 or 800-344-3860 Toll Free USA/Canada
Fax: 303-675-2176 or 800-344-3867 Toll Free USA/Canada
Email: orderlit@onsemi.com

N. American Technical Support: 800-282-9855 Toll Free USA/Canada
Europe, Middle East and Africa Technical Support:
 Phone: 421 33 790 2910
Japan Customer Focus Center
 Phone: 81-3-5817-1050

ON Semiconductor Website: www.onsemi.com
Order Literature: <http://www.onsemi.com/orderlit>

For additional information, please contact your local Sales Representative