

KEMET Part Number: SSHB21HS-R06780
(UALSB2SR067800)

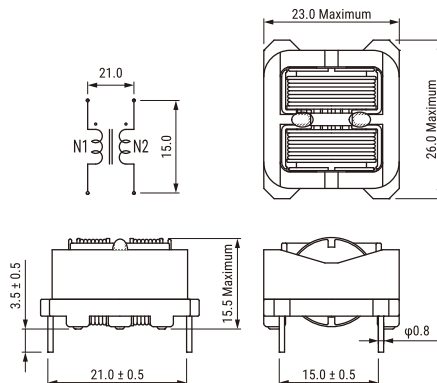

KEMET, SSHB21HS, AC Line Filters, Dual Mode, 78 mH



Dimensions

L	26mm MAX
T	23mm MAX
H	15.5mm MAX
LL	3.5mm +/-0.5mm
S	21mm +/-0.5mm
S1	15mm NOM
Wire Size	0.25mm

Packaging Specifications

Packaging:	Tray
Packaging Quantity:	360
Component Weight:	14 g

General Information

Series:	SSHB21HS
Style:	Through-Hole
RoHS:	Yes
Notes:	Marking: R06 Lot No.
Miscellaneous:	Temperature Rise Maximum: 60 K
Core:	Mn-Zn Ferrite

Specifications

Voltage AC:	250 VAC
Inductance:	78 mH (10 kHz)
Current:	600 mA
Temperature Range:	-25/+120°C
DC Resistance:	1.48 Ohms

Statements of suitability for certain applications are based on our knowledge of typical operating conditions for such applications, but are not intended to constitute - and we specifically disclaim - any warranty concerning suitability for a specific customer application or use. This Information is intended for use only by customers who have the requisite experience and capability to determine the correct products for their application. Any technical advice inferred from this Information or otherwise provided by us with reference to the use of our products is given gratis, and we assume no obligation or liability for the advice given or results obtained.

