

MAXIM

Quad 8-Bit DACs with Rail-to-Rail Voltage Outputs

MAX505/MAX506

General Description

The MAX505 and MAX506 are CMOS, quad, 8-bit voltage-output digital-to-analog converters (DACs). The parts operate with a single +5V supply or dual $\pm 5V$ supplies. Internal, precision output buffers swing rail-to-rail. The reference input range includes both supply rails.

Offset, gain, and linearity are factory calibrated to provide 1LSB total unadjusted error (TUE) over the full operating temperature range.

The MAX505 contains double-buffered logic inputs, which allow all analog outputs to be simultaneously updated using the asynchronous load DAC (LDAC) control signal. The MAX505 also has four separate reference inputs, allowing each DAC's full-scale range to be independently set.

The MAX506 has separate input latches for each of its four DACs. Data is transferred to the input latches from a common 8-bit input port. The DACs are individually selected through address inputs A0 and A1, and updated by bringing WR low. All MAX506 DACs share a common reference input.

All logic inputs are TTL and +5V CMOS compatible.

Applications

- Minimum Component Count Analog Systems
- Digital Offset/Gain Adjustment
- Arbitrary Function Generators
- Industrial Process Control
- Automatic Test Equipment
- Programmable Attenuators

Functional Diagrams



Features

- ◆ Operate from Single +5V Supply or Dual $\pm 5V$ Supplies
- ◆ Output Buffer Amplifiers Swing Rail-to-Rail
- ◆ Reference Input Range Includes Both Supply Rails
- ◆ Factory-Calibrated for 1LSB TUE
- ◆ Double-Buffered Digital Inputs (MAX505)
- ◆ Microprocessor and TTL/CMOS Compatible
- ◆ Require No External Adjustments
- ◆ Pin-Compatible Upgrades to MX7225/MX7226
- ◆ Now Available in Tiny SSOP Package

Ordering Information

PART	TEMP. RANGE	PIN-PACKAGE	TUE (LSBs)
MAX505ACNG	0°C to +70°C	24 Narrow Plastic DIP	± 1
MAX505BCNG	0°C to +70°C	24 Narrow Plastic DIP	$\pm 1\frac{1}{2}$
MAX505ACWG	0°C to +70°C	24 Wide SO	± 1
MAX505BCWG	0°C to +70°C	24 Wide SO	$\pm 1\frac{1}{2}$
MAX505ACAG	0°C to +70°C	24 SSOP	± 1
MAX505BCAG	0°C to +70°C	24 SSOP	$\pm 1\frac{1}{2}$
MAX505BC/D	0°C to +70°C	Dice*	$\pm 1\frac{1}{2}$

Ordering Information continued on last page.

* Contact factory for dice specifications.

**Contact factory for availability and processing to MIL-STD-883.

Pin Configurations

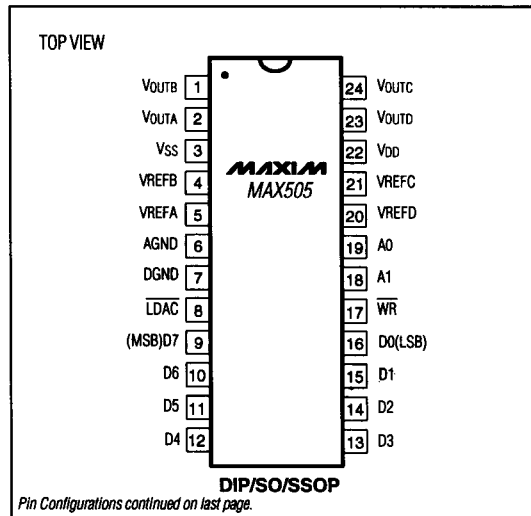

Quad 8-Bit DACs with Rail-to-Rail Voltage Outputs

ABSOLUTE MAXIMUM RATINGS

VDD to AGND	-0.3V, +8V
VDD to DGND	-0.3V, +6V
VSS to AGND	-7V, 0.3V
VSS to DGND	-7V, 0.3V
VDD to VSS	-0.3V, +12V
Digital Input Voltage to DGND	-0.3V, (VDD + 0.3V)
VREF	(VSS - 0.3V), (VDD + 0.3V)
VOUT (Note 1)	VSS, VDD
Continuous Power Dissipation (TA = +70°C)	
MAX505	
Plastic DIP (derate 13.33mW/°C above +70°C)	1067mW
Wide SO (derate 11.76mW/°C above +70°C)	941mW
CERDIP (derate 12.50mW/°C above +70°C)	1000mW
SSOP (derate 8mW/°C above +70°C)	640mW

MAX506	
Plastic DIP (derate 11.11mW/°C above +70°C)	889mW
Wide SO (derate 10.00mW/°C above +70°C)	800mW
CERDIP (derate 11.11mW/°C above +70°C)	889mW
Operating Temperature Ranges:	
MAX50_C	0°C to +70°C
MAX50_E	-40°C to +85°C
MAX50_M	-55°C to +125°C
Storage Temperature Range	-65°C to +165°C
Lead Temperature (soldering, 10 sec)	+300°C

Note 1: The outputs may be shorted to VDD, VSS, or AGND if the package power dissipation is not exceeded. Typical short-circuit current to AGND is 50mA.

Stresses beyond those listed under 'Absolute Maximum Ratings' may cause permanent damage to the device. These are stress ratings only, and functional operation of the device at these or any other conditions beyond those indicated in the operational sections of the specifications is not implied. Exposure to absolute maximum rating conditions for extended periods may affect device reliability.

ELECTRICAL CHARACTERISTICS

(VDD = +5V ±10%, VSS = 0V to -5.5V, AGND = DGND = 0V, VREF = 4V, RL = 10kΩ, CL = 100pF, TA = TMIN to TMAX, unless otherwise noted.)

PARAMETER	SYMBOL	CONDITIONS	MIN	TYP	MAX	UNITS
STATIC ACCURACY						
Resolution			8			Bits
Total Unadjusted Error	TUE	VREF = +4V, VSS = 0V or -5V ±10%	MAX50_A	±1		LSB
			MAX50_B	±1½		
		VREF = -4V, VSS = -5V ±10%	MAX50_A	±1		
			MAX50_B	±1½		
Differential Nonlinearity	DNL	Guaranteed monotonic	±1		LSB	
Zero-Code Error	ZCE	Code = 00 hex, VSS = 0V	MAX50_C	14		mV
			MAX50_E	16		
			MAX50_M	20		
		Code = 00 hex, VSS = -5V ±10%	MAX50_C	±14		
			MAX50_E	±16		
			MAX50_M	±20		
Zero-Code Error Supply Rejection		Code = 00 hex, VDD = 5V ±10%, VSS = 0V or -5V ±10%	1	2	mV	
Zero-Code Temperature Coefficient		Code = 00 hex	±10		µV/°C	
Full-Scale Error		Code = FF hex	±14		mV	
Full-Scale Error Supply Rejection		Code = FF hex, VDD = +5V ±10%, VSS = 0V or -5V ±10%	MAX50_C	1	4	mV
			MAX50_E	1	8	
			MAX50_M	12		
Full-Scale Error Temperature Coefficient		Code = FF hex	±10		µV/°C	

Quad 8-Bit DACs with Rail-to-Rail Voltage Outputs

MAX505/MAX506

ELECTRICAL CHARACTERISTICS (continued)

($V_{DD} = +5V \pm 10\%$, $V_{SS} = 0V$ to $-5.5V$, $AGND = DGND = 0V$, $V_{REF} = 4V$, $R_L = 10k\Omega$, $C_L = 100pF$, $T_A = T_{MIN}$ to T_{MAX} , unless otherwise noted.)

PARAMETER	SYMBOL	CONDITIONS	MIN	TYP	MAX	UNITS
REFERENCE INPUTS						
Input Voltage Range			V_{SS}		V_{DD}	V
Input Resistance (Note 2)		Code = 55 hex	MAX505	16	24	k Ω
			MAX506	4	6	
Input Capacitance (Note 3)		Code = 00 hex	MAX505	15		pF
			MAX506	40		
Channel-to-Channel Isolation		MAX505 (Note 4)		-60		dB
AC Feedthrough		MAX505 (Note 5)		-70		dB
DAC OUTPUTS						
Full-Scale Output Voltage			V_{SS}		V_{DD}	V
Resistive Load		$V_{OUT} = 4V$, load regulation $\leq 1/4LSB$	2			k Ω
		$V_{OUT} = -4V$, load regulation $\leq 1/4LSB$	2			
		$V_{OUT} = V_{DD}$ MAX50_C/E load regulation $\leq 1.5LSB$	10			
		$V_{OUT} = V_{DD}$ MAX50_M load regulation $\leq 2LSB$	10			
DIGITAL INPUTS						
Logic High	V_{IH}		2.4			V
Logic Low	V_{IL}			0.8		V
Input Current		Measured at V_{IH} and V_{IL}		± 1		μA
Input Capacitance				8		pF
Input Coding			Binary			
DYNAMIC PERFORMANCE						
Voltage-Output Slew Rate		Positive and negative	MAX50_C	1.0		V/ μs
			MAX50_E	0.7		
			MAX50_M	0.5		
Output Settling Time		To $\pm 1/2LSB$, $10k\Omega$ $100pF$ load (Note 6)		6		μs
Digital Feedthrough		Code = 00 hex, $WR = V_{DD}$, all digital inputs from 0V to V_{DD}		5		nV-s
Signal to (Noise + Distortion) Ratio		$V_{REF} = 4V_{p-p}$ at 1kHz, $V_{DD} = 5V$, $V_{SS} = -5V$, code = FF hex		87		dB
		$V_{REF} = 4V_{p-p}$ at 20kHz, $V_{SS} = -5V \pm 10\%$		-74		dB
Multiplying Bandwidth		$V_{REF} = 0.5V_{p-p}$, 3dB bandwidth		1		MHz
Wideband Amplifier Noise				60		$\mu VRMS$

Quad 8-Bit DACs with Rail-to-Rail Voltage Outputs

ELECTRICAL CHARACTERISTICS (continued)

(VDD = +5V ±10%, VSS = 0V to -5.5V, AGND = DGND = 0V, VREF = 4V, RL = 10kΩ, CL = 100pF, TA = TMIN to TMAX, unless otherwise noted.)

PARAMETER	SYMBOL	CONDITIONS	MIN	TYP	MAX	UNITS
POWER SUPPLIES						
Positive Supply Voltage	VDD	For specified performance	4.5		5.5	V
Negative Supply Voltage	VSS	For specified performance	-5.5		0	V
Positive Supply Current	IDD	Outputs unloaded, all digital inputs = 0V or VDD	MAX50_C/E	5	10	mA
			MAX50_M	5	12	
Negative Supply Current	ISS	VSS = -5V ±10%, outputs unloaded, all digital inputs = 0V or VDD	MAX50_C/E	5	10	mA
			MAX50_M	5	12	
SWITCHING CHARACTERISTICS						
Address to \overline{WR} Setup	tAS		5	-8		ns
Address to \overline{WR} Hold	tAH		5	-4		ns
Data to \overline{WR} Setup	tDS		45	35		ns
Data to \overline{WR} Hold	tDH		0	-13		ns
\overline{WR} Pulse Width	tWR		40	20		ns
\overline{LDAC} Pulse Width	tLC		40	20		ns

Note 2: Input resistance is code dependent. The lowest input resistance occurs at code = 55 hex.

Note 3: Input capacitance is code dependent. The highest input capacitance occurs at code = 00 hex.

Note 4: VREF = 10kHz, 4Vp-p. Channel-to-channel isolation is measured by setting the code of one DAC to FF hex and setting the code of all other DACs to 00 hex.

Note 5: VREF = 10kHz, 4Vp-p. DAC code = 00 hex.

Note 6: Output settling time is measured by taking the code from 00 hex to FF hex, and from FF hex to 00 hex.

Typical Operating Characteristics

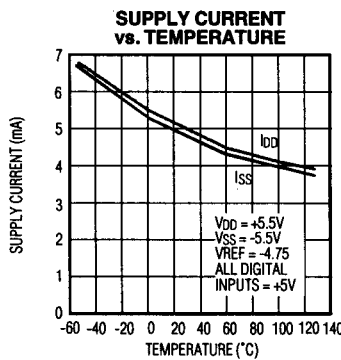
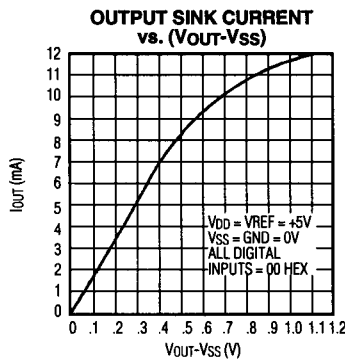

Quad 8-Bit DACs with Rail-to-Rail Voltage Outputs

Typical Operating Characteristics (continued)

MAX505/MAX506

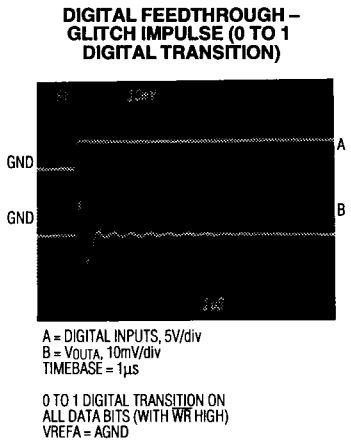
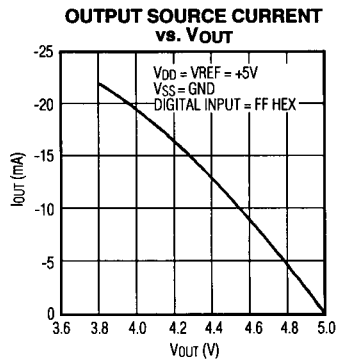

Quad 8-Bit DACs with Rail-to-Rail Voltage Outputs

Typical Operating Characteristics (continued)

REFERENCE FEEDTHROUGH AT 400Hz



A = VREF, 10Vp-p
 B = VOUT, 50µV/div, UNLOADED
 TIMEBASE = 1ms/div
 VDD = +5V
 VSS = -5V
 CODE = ALL 0s
 LOAD = ∞

REFERENCE FEEDTHROUGH AT 4000Hz



A = VREF, 10Vp-p
 B = VOUT, 100µV/div, UNLOADED
 TIMEBASE = 100µs/div
 VDD = +5V
 VSS = -5V
 CODE = ALL 0s
 LOAD = ∞

POSITIVE SETTLING TIME (VSS = AGND)



A = DIGITAL INPUT, 5V/div
 B = VOUT, 2V/div
 TIMEBASE = 1µs
 VDD = +5V
 VREF = +5V
 ALL BITS OFF TO ALL BITS ON
 RL = 10kΩ, CL = 100pF

POSITIVE SETTLING TIME (VSS = -5V)

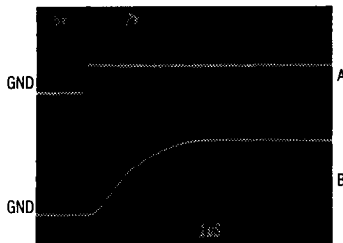

A = DIGITAL INPUT, 5V/div
 B = VOUT, 2V/div
 TIMEBASE = 1µs
 VDD = +5V
 VREF = +5V
 ALL BITS OFF TO ALL BITS ON
 RL = 10kΩ, CL = 100pF

NEGATIVE SETTLING TIME (VSS = AGND)

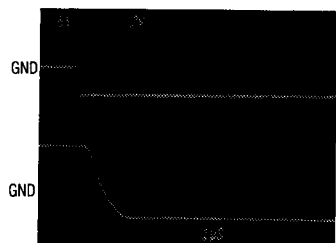

A = DIGITAL INPUT, 5V/div
 B = VOUT, 2V/div
 TIMEBASE = 1µs
 VDD = +5V
 VREF = +5V
 ALL BITS ON TO ALL BITS OFF
 RL = 10kΩ, CL = 100pF

NEGATIVE SETTLING TIME (VSS = -5V)



A = DIGITAL INPUT, 5V/div
 B = VOUT, 2V/div
 TIMEBASE = 1µs
 VDD = +5V
 VREF = +5V
 ALL BITS ON TO ALL BITS OFF
 RL = 10kΩ, CL = 100pF

Quad 8-Bit DACs with Rail-to-Rail Voltage Outputs

Pin Description

MAX505/MAX506

PIN		NAME	FUNCTION
MAX505	MAX506		
1	1	VOUTB	DAC B Output Voltage
2	2	VOUTA	DAC A Output Voltage
3	3	VSS	Negative Power Supply
4		VREFB	Reference Voltage Input for DAC B
	4	VREF	Reference Voltage Input for DAC A to DAC D
5		VREFA	Reference Voltage Input for DAC A
6	5	AGND	Analog Ground
7	6	DGND	Digital Ground
8		$\overline{\text{LDAC}}$	Load DAC Input (active low). Driving this asynchronous input low transfers the contents of each input latch to its respective DAC latch.
9	7	D7	Data Bit 7 (MSB)
10	8	D6	Data Bit 6
11	9	D5	Data Bit 5
12	10	D4	Data Bit 4
13	11	D3	Data Bit 3
14	12	D2	Data Bit 2
15	13	D1	Data Bit 1
16	14	D0	Data Bit 0 (LSB)
17	15	$\overline{\text{WR}}$	Write Input (active low). Used to load data into the DAC input latch selected by A0 and A1.
18	16	A1	DAC Address select bit (MSB)
19	17	A0	DAC Address select bit (LSB)
20		VREFD	Reference Voltage Input for DAC D
21		VREFC	Reference Voltage Input for DAC C
22	18	VDD	Positive Supply Voltage
23	19	VOUTD	DAC D Output Voltage
24	20	VOUTC	DAC C Output Voltage

Quad 8-Bit DACs with Rail-to-Rail Voltage Outputs

Detailed Description

Digital-to-Analog Section

The MAX505/MAX506 contain four matched voltage-output DACs. The DACs are inverted R-2R ladder networks that convert 8-bit digital words into equivalent analog output voltages in proportion to the applied reference voltage(s). Each DAC in the MAX505 has a separate reference input, while all four DACs in the MAX506 share a common reference input. Figure 1 shows a simplified functional diagram of one of the DACs.



Figure 1. DAC Simplified Circuit Diagram

Power Supplies and Reference Input

The MAX505/MAX506 can be used for multiplying applications. The reference accepts both DC and AC signals. The voltage at each VREF input sets the full-scale output voltage for its respective DAC. The VREF input impedance is code dependent, with the lowest value (16k Ω for the MAX505 and 4k Ω for the MAX506) occurring when the input code is 55 hex. The maximum value, essentially infinity, occurs when

the input code is 00 hex. Since the VREF input impedance is code dependent, the DACs' reference sources must have a low output impedance (no more than 32 Ω for the MAX505 and 8 Ω for the MAX506) to maintain output linearity. The VREF input capacitance is also code dependent: 15pF maximum for the MAX505 and 40pF maximum for the MAX506.

The output voltage for any DAC can be represented by a digitally programmable voltage source as:

$$V_{OUT} = (N_B \times V_{REF}) / 256$$

where N_B is the numeric value of the DAC's binary input code.

Output Buffer Amplifiers

All MAX505/MAX506 voltage outputs are internally buffered by precision unity-gain followers that slew at 1V/ μ s. With a 0V to +4V (or +4V to 0V) output transition, the amplifier outputs will settle to 1/2LSB in typically 6 μ s when loaded with 10k Ω in parallel with 100pF.

The buffer amplifiers are stable with any combination of resistive loads \geq 2k Ω and capacitive loads \leq 300pF.

Digital Inputs and Interface Logic

The digital inputs are compatible with both TTL and 5V CMOS logic. However, the power-supply current (I_{DD}) depends on the input logic levels. Supply current is specified for CMOS input levels (best case). Supply current increases by about 2mA when driven with TTL logic levels.

Address lines A0 and A1 select which DAC receives data from the data bus as shown in Table 1. When \overline{WR} is low, the addressed DAC's input latch is transparent. Data is latched when \overline{WR} is high. Figure 2 shows the MAX505/MAX506 input control logic.

The MAX506 DAC outputs represent the data held in the four 8-bit input latches. The MAX505 has double-buffered inputs; in addition to the input registers, there are individual DAC latches (see *Functional Diagrams*).

Quad 8-Bit DACs with Rail-to-Rail Voltage Outputs

MAX505/MAX506



Figure 2. MAX505/MAX506 Input Control Logic

In the MAX505, data is transferred from the input latches to the DAC latches by pulling the LDAC control input low. This operation simultaneously updates all four outputs. Since LDAC is asynchronous with respect to WR, be sure that incorrect data is not latched to the output. Table 1a is the write-cycle truth table for the MAX505. Table 1b is the write-cycle truth table for the MAX506. Figure 3 shows the MAX505/MAX506 write-cycle timing. If simultaneous updating is not required, tie LDAC low to keep the DAC latches transparent. To avoid output glitches, insure that data is valid before WR goes low (MAX506). This also applies to the MAX505 if WR and LDAC are low simultaneously.

On power-up, all MAX505/MAX506 latches are internally preset with all 0s.

Table 1a. MAX505 DAC Addressing (partial list)

LDAC	WR	A1	A0	LATCH STATE
H	H	X	X	Input and DAC data latched
H	L	L	L	DAC A input latch transparent
L	H	X	X	All 4 DACs' DAC latches transparent
L	L	L	L	DAC A input registers transparent and all 4 DACs' DAC latches transparent
H	L	L	H	DAC B input latch transparent
H	L	H	L	DAC C input latch transparent
H	L	H	H	DAC D input latch transparent

H = High State, L = Low State, X = Don't Care

Table 1b. MAX506 DAC Addressing (partial list)

WR	A1	A0	LATCH STATE
H	X	X	Input data latched
L	L	L	DAC A input latch transparent
L	L	H	DAC B input latch transparent
L	H	L	DAC C input latch transparent
L	H	H	DAC D input latch transparent

H = High State, L = Low State, X = Don't Care

Quad 8-Bit DACs with Rail-to-Rail Voltage Outputs



Figure 3. MAX505/MAX506 Write-Cycle Timing Diagram

Applications Information

Power Supply and Reference Operating Ranges

The MAX505/MAX506 are fully specified to operate with $V_{DD} = 5V \pm 10\%$ and $V_{SS} = 0V$ to $-5.5V$. 8-bit performance is guaranteed for both single- and dual-supply operation. The zero-code output error is guaranteed to be less than 14mV when operating from a single +5V supply.

The DACs work well with reference voltages from V_{SS} to V_{DD} .

V_{SS} should never be more positive than either AGND or DGND. No input should be more positive than V_{DD} .

Power-Supply Bypassing and Ground Management

In single-supply operation ($\text{AGND} = \text{DGND} = V_{SS} = 0V$), AGND, DGND, and V_{SS} should be connected together in a "star" ground at the chip. This ground should then return to the highest quality ground available. Bypass V_{DD} with a $0.1\mu\text{F}$ capacitor, located as close to V_{DD} and AGND as possible.

In dual-supply operation, where $\text{DGND} = \text{AGND}$, V_{DD} and V_{SS} should be bypassed with $0.1\mu\text{F}$ capacitors to AGND. These capacitors should be placed as close to the supply pins as possible. To minimize digital noise on AGND, DGND and AGND should have separate return paths to the highest quality ground available.

Careful PCB layout minimizes crosstalk between DAC outputs, reference inputs, and digital inputs. Figures 4 and 5 show suggested circuit board layouts to minimize crosstalk.



Figure 4. Suggested MAX505 PCB Layout for Minimizing Crosstalk

Quad 8-Bit DACs with Rail-to-Rail Voltage Outputs

MAX505/MAX506



Figure 5. Suggested MAX506 PCB Layout for Minimizing Crosstalk



Figure 6. MAX505 Unipolar Output Circuit

Unipolar Output, 2-Quadrant Multiplication

In unipolar operation, the output voltages and the reference input(s) are the same polarity. Figures 6 and 7 show the MAX505/MAX506 unipolar configurations. If the reference inputs are positive, both devices can be operated from a single supply. If dual supplies are used, the reference input can vary from VSS to VDD. Table 2 is the unipolar code table.

Bipolar Output, 2-Quadrant Multiplication

Bipolar output 2-quadrant multiplication is achieved by offsetting AGND positively or negatively.

Offsetting AGND Positively - Single or Dual Supplies

AGND can be biased above DGND to provide an arbitrary nonzero output voltage for a 0 input code, as shown in Figure 8. The output voltage at VOUTA is:

$$V_{OUTA} = V_{BIAS} + (N_B/256)(V_{IN}),$$

where N_B represents the digital input word. Since AGND is common to all four DACs, all outputs will be offset by V_{BIAS} in the same manner. AGND should not be biased more than +1V above DGND.



Figure 7. MAX506 Unipolar Output Circuit

Quad 8-Bit DACs with Rail-to-Rail Voltage Outputs

Table 2. Unipolar Code Table

DAC CONTENTS		ANALOG OUTPUT
MSB	LSB	
1111	1111	+VREF $\left(\frac{255}{256}\right)$
1000	0001	+VREF $\left(\frac{129}{256}\right)$
1000	0000	+VREF $\left(\frac{128}{256}\right) = +\frac{VREF}{2}$
0111	1111	+VREF $\left(\frac{127}{256}\right)$
0000	0001	+VREF $\left(\frac{1}{256}\right)$
0000	0000	0V

Note: 1LSB = (VREF) (2⁻⁸) = +VREF $\left(\frac{1}{256}\right)$

Offsetting AGND Negatively - Dual Supplies

An alternate method of generating bipolar outputs uses Figure 9's circuits. In these circuits, AGND is biased negatively (up to -2.5V with respect to DGND) to provide an arbitrary negative output voltage for a 0 input code. The output voltage at V_{OUTA} is:

$$V_{OUTA} = -(R2/R1) (2.5V) + (N_B/256) (2.5V) (R2/R1 + 1)$$

where N_B represents the digital input word. Since AGND is common to all four DACs, all outputs will be offset by V_{BIAS} in the same manner. Table 3, with VREF = 2.5V, shows the digital code vs. output voltage for Figure 9's circuits with R1 = R2.

4-Quadrant Multiplication

Each DAC output may be configured for 4-quadrant multiplication using Figure 10's circuit. One op amp and two resistors are required per channel. With R1 = R2:

$$V_{OUT} = VREF [(2)(N_B/256) - 1],$$

where N_B represents the digital word in DAC register A.

Recommended values for resistors R1 and R2 are 330kΩ (±0.1%). Table 3 shows the digital code vs. output voltage for Figure 10's circuit.

Table 3. Bipolar Code Table

DAC CONTENTS		ANALOG OUTPUT
MSB	LSB	
1111	1111	VREF $\left(\frac{127}{128}\right)$
1000	0001	VREF $\left(\frac{1}{128}\right)$
1000	0000	0V
0111	1111	-VREF $\left(\frac{1}{128}\right)$
0000	0001	-VREF $\left(\frac{127}{128}\right)$
0000	0000	-VREF $\left(\frac{128}{128}\right) = -VREF$

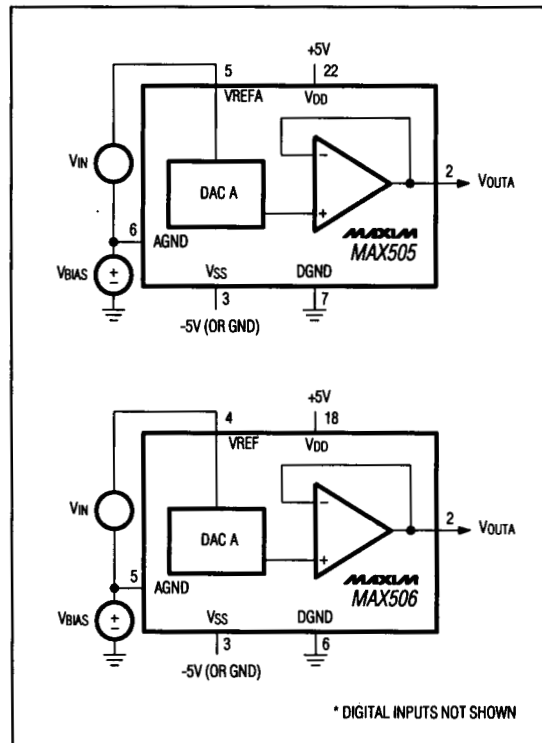

Figure 8. AGND Bias Circuits (Positive Offset)

Quad 8-Bit DACs with Rail-to-Rail Voltage Outputs

MAX505/MAX506



Figure 9a. MAX505 AGND Bias Circuit (Negative Offset)



Figure 9b. MAX506 AGND Bias Circuit (Negative Offset)

Quad 8-Bit DACs with Rail-to-Rail Voltage Outputs



Figure 10a. MAX505 Bipolar Output Circuit



Figure 10b. MAX506 Bipolar Output Circuit

Quad 8-Bit DACs with Rail-to-Rail Voltage Outputs

Functional Diagrams (continued)



Pin Configurations (continued)



MAX505/MAX506

Ordering Information

PART	TEMP. RANGE	PIN-PACKAGE	TUE (LSBs)
MAX505AENG	-40°C to +85°C	24 Narrow Plastic DIP	±1
MAX505BENG	-40°C to +85°C	24 Narrow Plastic DIP	±1½
MAX505AEWG	-40°C to +85°C	24 Wide SO	±1
MAX505BEWG	-40°C to +85°C	24 Wide SO	±1½
MAX505AEAG	-40°C to +85°C	24 SSOP	±1
MAX505BEAG	-40°C to +85°C	24 SSOP	±1½
MAX505AMRG	-55°C to +125°C	24 Narrow CERDIP**	±1
MAX505BMRG	-55°C to +125°C	24 Narrow CERDIP**	±1½
MAX506ACPP	0°C to +70°C	20 Plastic DIP	±1
MAX506BCPP	0°C to +70°C	20 Plastic DIP	±1½
MAX506ACWP	0°C to +70°C	20 Wide SO	±1
MAX506BCWP	0°C to +70°C	20 Wide SO	±1½
MAX506BC/D	0°C to +70°C	Dice*	±1½
MAX506AEPP	-40°C to +85°C	20 Plastic DIP	±1
MAX506BEPP	-40°C to +85°C	20 Plastic DIP	±1½
MAX506AEWP	-40°C to +85°C	20 Wide SO	±1
MAX506BEWP	-40°C to +85°C	20 Wide SO	±1½
MAX506AMJP	-55°C to +125°C	20 CERDIP**	±1
MAX506BMJP	-55°C to +125°C	20 CERDIP**	±1½

* Contact factory for dice specifications.

**Contact factory for availability and processing to MIL-STD-883.

Quad 8-Bit DACs with Rail-to-Rail Voltage Outputs

Chip Topographies



Package Information



Maxim cannot assume responsibility for use of any circuitry other than circuitry entirely embodied in a Maxim product. No circuit patent licenses are implied. Maxim reserves the right to change the circuitry and specifications without notice at any time.

16 Maxim Integrated Products, 120 San Gabriel Drive, Sunnyvale, CA 94086 (408) 737-7600

© 1994 Maxim Integrated Products

Printed USA

MAXIM is a registered trademark of Maxim Integrated Products.

Mouser Electronics

Authorized Distributor

Click to View Pricing, Inventory, Delivery & Lifecycle Information:

Analog Devices Inc.:

[MAX506ACPP+](#) [MAX506ACWP+](#) [MAX506AEWP+](#) [MAX506BCPP+](#) [MAX506BCWP+](#) [MAX506BEWP+](#)
[MAX506ACWP+T](#) [MAX506AEPP+](#) [MAX506AEWP+T](#) [MAX506BCWP+T](#) [MAX506BEWP+T](#)