

Description

The HSBA3016 is the high cell density trenched N-ch MOSFETs, which provide excellent R_{DS(ON)} and gate charge for most of the synchronous buck converter applications.

The HSBA3016 meet the RoHS and Green Product requirement 100% EAS guaranteed with full function reliability approved.

- 100% EAS Guaranteed
- Green Device Available
- Super Low Gate Charge
- Excellent CdV/dt effect decline
- Advanced high cell density Trench technology

Product Summary

V _{DS}	30	V
R _{DS(ON),max}	4	mΩ
I _D	108	A

PRPAK5X6 Pin Configuration

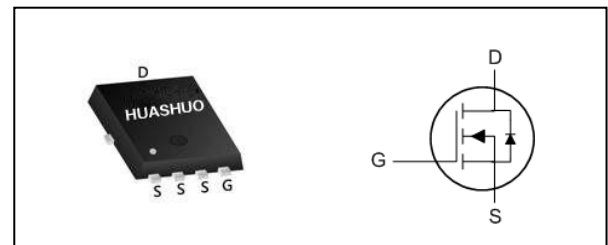

Absolute Maximum Ratings

Symbol	Parameter	Rating		Units
		10s	Steady State	
V _{DS}	Drain-Source Voltage	30		V
V _{GS}	Gate-Source Voltage	±20		V
I _D @T _C =25°C	Continuous Drain Current, V _{GS} @ 10V _{1.6}	108		A
I _D @T _C =100°C	Continuous Drain Current, V _{GS} @ 10V _{1.6}	68		A
I _D @T _A =25°C	Continuous Drain Current, V _{GS} @ 10V ₁	27.3	17.3	A
I _D @T _A =70°C	Continuous Drain Current, V _{GS} @ 10V ₁	21.8	14	A
I _{DM}	Pulsed Drain Current ₂	216		A
EAS	Single Pulse Avalanche Energy ₃	144.7		mJ
I _{AS}	Avalanche Current	53.8		A
P _D @T _C =25°C	Total Power Dissipation ₄	69		W
P _D @T _A =25°C	Total Power Dissipation ₄	5	2	W
T _{STG}	Storage Temperature Range	-55 to 175		°C
T _J	Operating Junction Temperature Range	-55 to 175		°C

Thermal Data

Symbol	Parameter	Typ.	Max.	Unit
R _{θJA}	Thermal Resistance Junction-Ambient ₁	---	62	°C/W
R _{θJA}	Thermal Resistance Junction-Ambient ₁ (t ≤ 10s)	---	25	°C/W
R _{θJC}	Thermal Resistance Junction-Case ₁	---	1.8	°C/W



Electrical Characteristics (T_J=25 °C, unless otherwise noted)

Symbol	Parameter	Conditions	Min.	Typ.	Max.	Unit
BV _{DSS}	Drain-Source Breakdown Voltage	V _{GS} =0V, I _D =250uA	30	---	---	V
ΔBV _{DSS} /ΔT _J	BVDSS Temperature Coefficient	Reference to 25°C, I _D =1mA	---	0.0213	---	V/°C
R _{DS(ON)}	Static Drain-Source On-Resistance ₂	V _{GS} =10V, I _D =30A	---	---	4	mΩ
		V _{GS} =4.5V, I _D =15A	---	---	6	
V _{GS(th)}	Gate Threshold Voltage	V _{GS} =V _{DS} , I _D =250uA	1.2	---	2.5	V
ΔV _{GS(th)}	V _{GS(th)} Temperature Coefficient		---	-5.73	---	mV/°C
I _{DSS}	Drain-Source Leakage Current	V _{DS} =24V, V _{GS} =0V, T _J =25°C	---	---	1	uA
		V _{DS} =24V, V _{GS} =0V, T _J =55°C	---	---	5	
I _{GSS}	Gate-Source Leakage Current	V _{GS} =±20V, V _{DS} =0V	---	---	±100	nA
g _{fs}	Forward Transconductance	V _{DS} =5V, I _D =30A	---	26.5	---	S
R _g	Gate Resistance	V _{DS} =0V, V _{GS} =0V, f=1MHz	---	1.4	---	Ω
Q _g	Total Gate Charge (4.5V)	V _{DS} =15V, V _{GS} =4.5V, I _D =15A	---	31.6	---	nC
Q _{gs}	Gate-Source Charge		---	8.6	---	
Q _{gd}	Gate-Drain Charge		---	11.7	---	
T _{d(on)}	Turn-On Delay Time	V _{DD} =15V, V _{GS} =10V, R _G =3.3Ω I _D =15A	---	9	---	ns
T _r	Rise Time		---	19	---	
T _{d(off)}	Turn-Off Delay Time		---	58	---	
T _f	Fall Time		---	15.2	---	
C _{iss}	Input Capacitance	V _{DS} =15V, V _{GS} =0V, f=1MHz	---	3075	---	pF
C _{oss}	Output Capacitance		---	400	---	
C _{rss}	Reverse Transfer Capacitance		---	315	---	

Diode Characteristics

Symbol	Parameter	Conditions	Min.	Typ.	Max.	Unit
I _S	Continuous Source Current _{1,5}	V _G =V _D =0V, Force Current	---	---	108	A
I _{SM}	Pulsed Source Current _{2,5}		---	---	216	A
V _{SD}	Diode Forward Voltage ₂	V _{GS} =0V, I _S =1A, T _J =25°C	---	---	1	V

Note :

- 1.The data tested by surface mounted on a 1 inch₂ FR-4 board with 2OZ copper.
- 2.The data tested by pulsed , pulse width ≤ 300us , duty cycle ≤ 2%
- 3.The EAS data shows Max. rating . The test condition is V_{DD}=25V, V_{GS}=10V, L=0.1mH, I_{AS}=53.8A
- 4.The power dissipation is limited by 175°C junction temperature
- 5.The data is theoretically the same as I_D and I_{DM} , in real applications , should be limited by total power dissipation.
- 6.Package limitation current is 85A.



Typical Characteristics

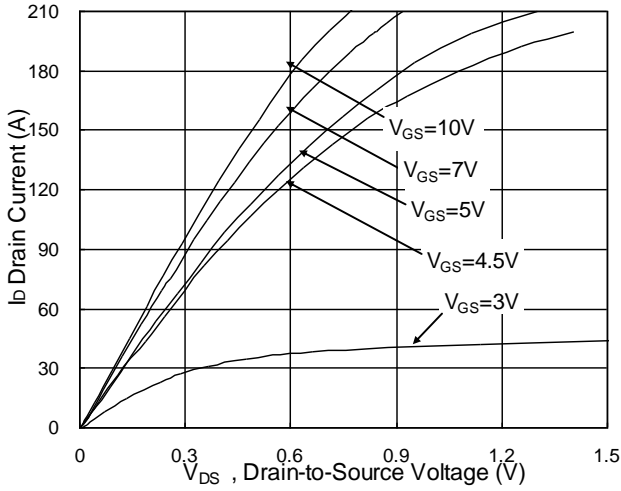

Fig.1 Typical Output Characteristics

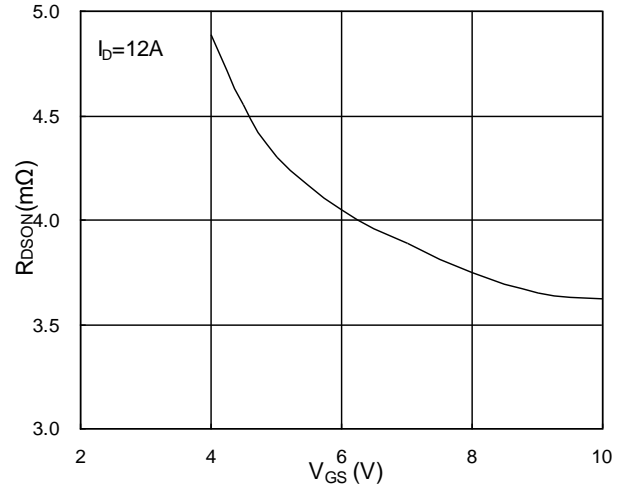

Fig.2 On-Resistance vs. G-S Voltage

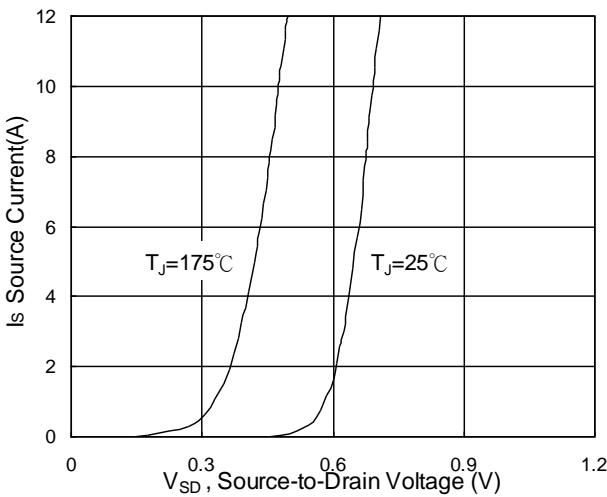

Fig.3 Forward Characteristics of Reverse

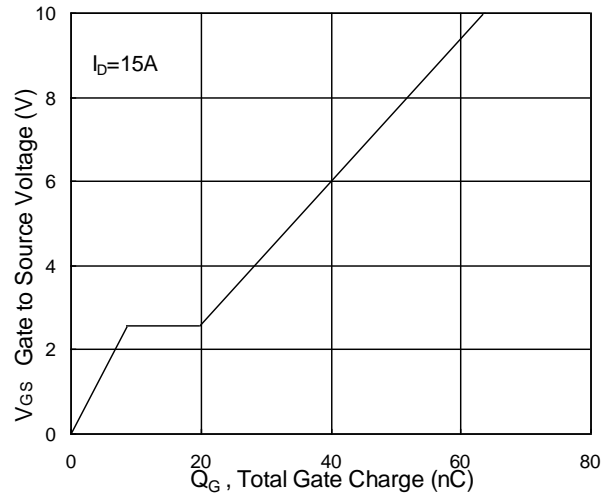

Fig.4 Gate-charge Characteristics

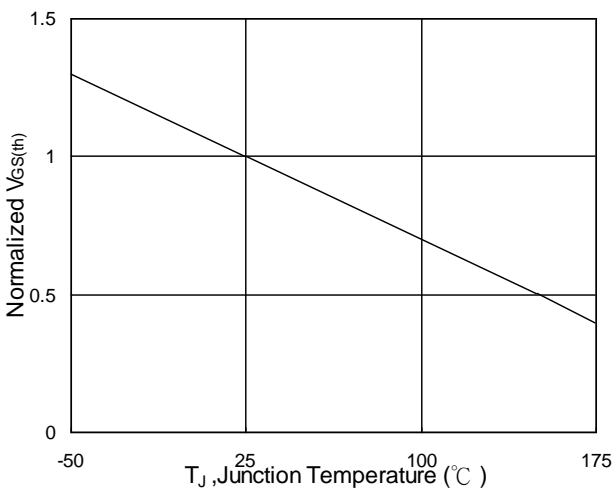

Fig.5 Normalized VGS(th) vs. TJ

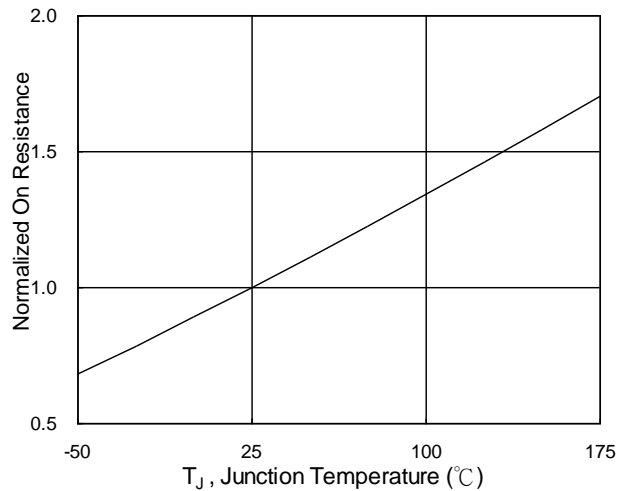

Fig.6 Normalized RDS(on) vs. TJ

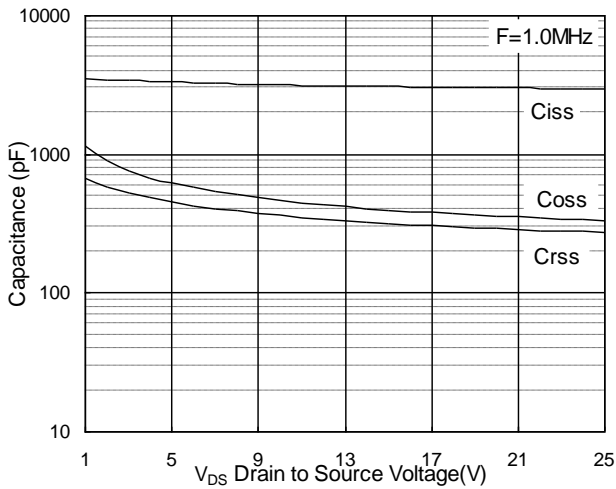

Fig.7 Capacitance

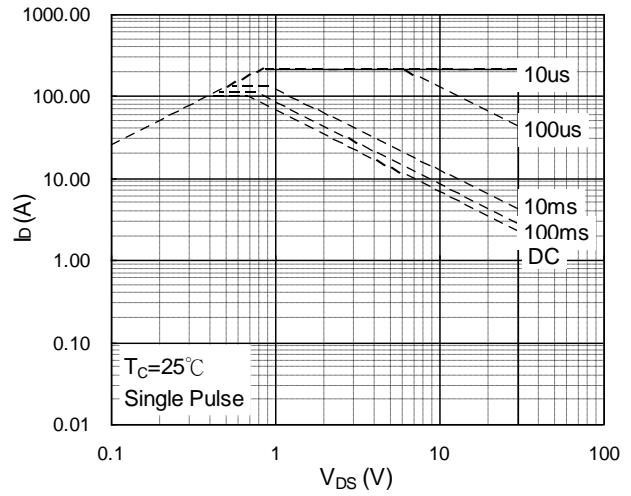

Fig.8 Safe Operating Area

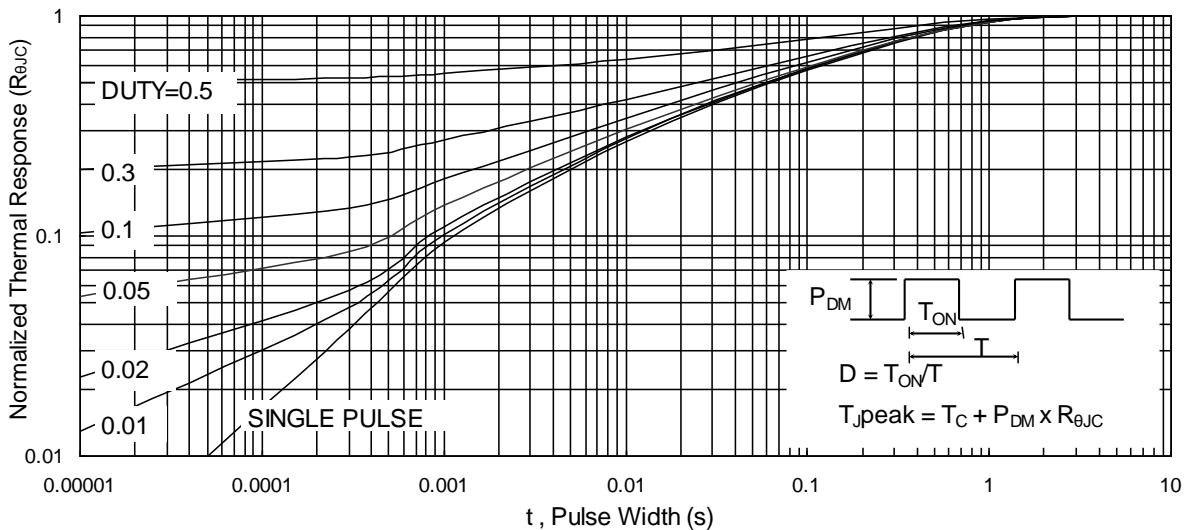

Fig.9 Normalized Maximum Transient Thermal Impedance

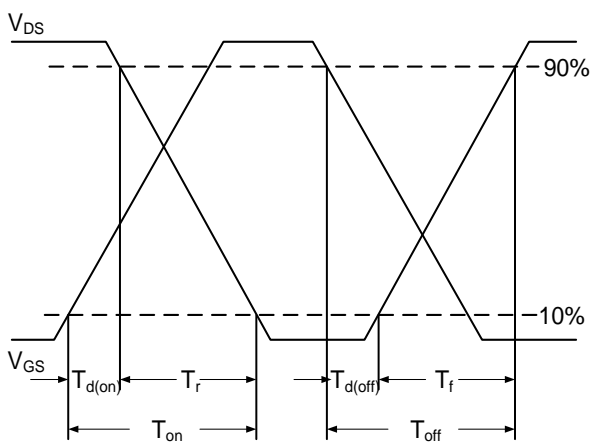

Fig.10 Switching Time Waveform

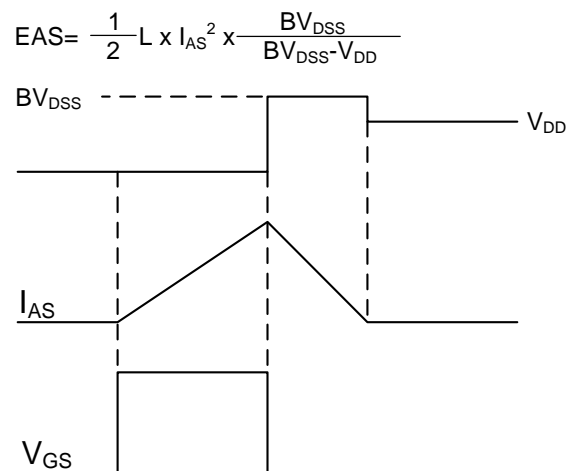
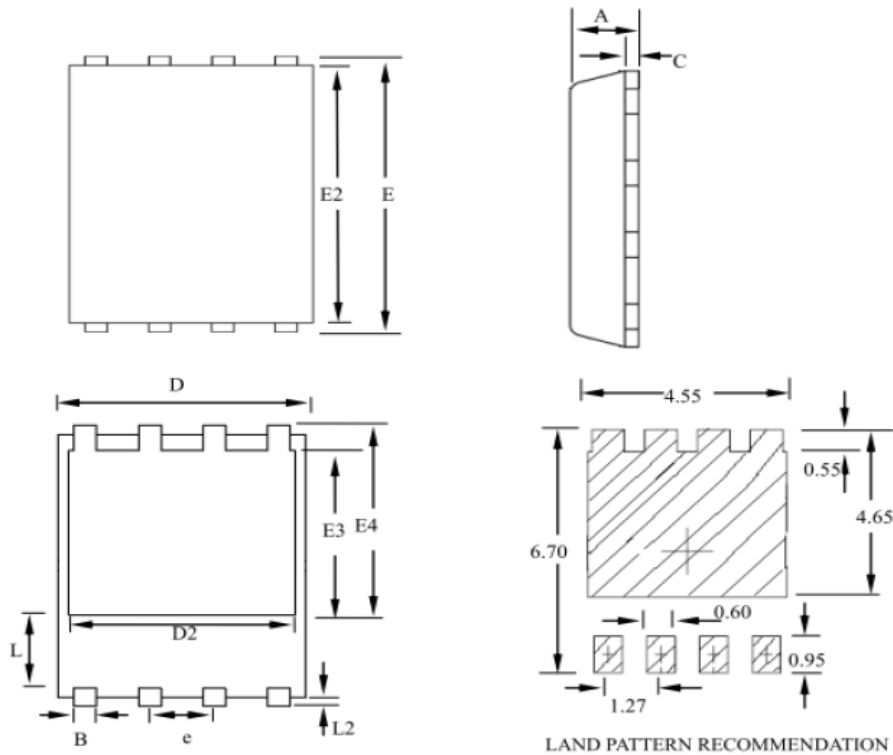

Fig.11 Unclamped Inductive Switching Waveform

Ordering Information

Part Number	Package code	Packaging
HSBA3016	PRPAK5*6	3000/Tape&Reel



SYMBOLS	MILLIMETERS			INCHES		
	MIN	NOM	MAX	MIN	NOM	MAX
A	0.80	--	1.20	0.031	--	0.047
B	0.30	--	0.51	0.012	--	0.020
C	0.15	--	0.35	0.006	--	0.014
D	4.80	--	5.30	0.189	--	0.209
D2	3.61	--	4.35	0.142	--	0.171
E	5.90	--	6.35	0.232	--	0.250
E2	5.42	--	5.90	0.213	--	0.232
E3	3.23	--	3.90	0.127	--	0.154
E4	3.69	--	4.55	0.145	--	0.179
L	0.61	--	1.80	0.024	--	0.071
L2	0.05	--	0.36	0.002	--	0.014
e	--	1.27	--	--	0.050	--