

# PCF

Chip Type, Standard

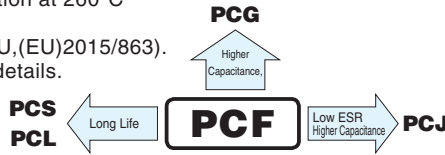

- Low ESR, High ripple current.
- Load life of 2000 hours at 105°C.
- SMD type : Lead free reflow soldering condition at 260°C peak correspondence.
- Compliant to the RoHS directive (2011/65/EU,(EU)2015/863).
- AEC-Q200 Qualified. Please contact us for details.



## Specifications

Item	Performance Characteristics									
Category Temperature Range	-55 to +105°C									
Rated Voltage Range	2.5 to 25V									
Rated Capacitance Range	6.8 to 1500µF									
Capacitance Tolerance	±20% at 120Hz, 20°C									
Tangent of loss angle (tan δ)	Less than or equal to the specified value at 120Hz, 20°C									
ESR (※ 1)	Less than or equal to the specified value at 100kHz, 20°C									
Leakage Current (※ 2)	Less than or equal to the specified value. After 2 minutes' application of rated voltage at 20°C									
Temperature Characteristics (Max.Impedance Ratio)	$Z(+105^{\circ}\text{C}) / Z(+20^{\circ}\text{C}) \leq 1.25$ (100kHz) $Z(-55^{\circ}\text{C}) / Z(+20^{\circ}\text{C}) \leq 1.25$									
Endurance	The specifications listed at right shall be met when the capacitors are restored to 20°C after the rated voltage is applied for 2000 hours at 105°C	<table border="1"> <tr><td>Capacitance change</td><td>Within ± 20% of the initial capacitance value (※3)</td></tr> <tr><td>tan δ</td><td>150% or less than the initial specified value</td></tr> <tr><td>ESR (※ 1)</td><td>150% or less than the initial specified value</td></tr> <tr><td>Leakage current (※ 2)</td><td>Less than or equal to the initial specified value</td></tr> </table>	Capacitance change	Within ± 20% of the initial capacitance value (※3)	tan δ	150% or less than the initial specified value	ESR (※ 1)	150% or less than the initial specified value	Leakage current (※ 2)	Less than or equal to the initial specified value
Capacitance change	Within ± 20% of the initial capacitance value (※3)									
tan δ	150% or less than the initial specified value									
ESR (※ 1)	150% or less than the initial specified value									
Leakage current (※ 2)	Less than or equal to the initial specified value									
Damp Heat (Steady State)	The specifications listed at right shall be met when the capacitors are restored to 20°C after the rated voltage is applied for 1000 hours at 60°C, 90% RH.	<table border="1"> <tr><td>Capacitance change</td><td>Within ± 20% of the initial capacitance value (※3)</td></tr> <tr><td>tan δ</td><td>150% or less than the initial specified value</td></tr> <tr><td>ESR (※ 1)</td><td>150% or less than the initial specified value</td></tr> <tr><td>Leakage current (※ 2)</td><td>Less than or equal to the initial specified value</td></tr> </table>	Capacitance change	Within ± 20% of the initial capacitance value (※3)	tan δ	150% or less than the initial specified value	ESR (※ 1)	150% or less than the initial specified value	Leakage current (※ 2)	Less than or equal to the initial specified value
Capacitance change	Within ± 20% of the initial capacitance value (※3)									
tan δ	150% or less than the initial specified value									
ESR (※ 1)	150% or less than the initial specified value									
Leakage current (※ 2)	Less than or equal to the initial specified value									
Resistance to Soldering Heat	After soldering the capacitor under the soldering conditions prescribed here, the capacitor shall meet the specifications listed at right. Pre-heating shall be done at 150 to 200°C and for 60 to 180 sec. The duration for over +230°C temperature at capacitor surface shall not exceed 60 seconds. In case peak temperature is 250°C or less, reflow soldering shall be two times maximum. In case peak temperature is 260°C or less, reflow soldering shall be once. Measurement for solder temperature profile shall be made at the capacitor top.	<table border="1"> <tr><td>Capacitance change</td><td>Within ± 10% of the initial capacitance value (※3)</td></tr> <tr><td>tan δ</td><td>130% or less than the initial specified value</td></tr> <tr><td>ESR (※ 1)</td><td>130% or less than the initial specified value</td></tr> <tr><td>Leakage current (※ 2)</td><td>Less than or equal to the initial specified value</td></tr> </table>	Capacitance change	Within ± 10% of the initial capacitance value (※3)	tan δ	130% or less than the initial specified value	ESR (※ 1)	130% or less than the initial specified value	Leakage current (※ 2)	Less than or equal to the initial specified value
Capacitance change	Within ± 10% of the initial capacitance value (※3)									
tan δ	130% or less than the initial specified value									
ESR (※ 1)	130% or less than the initial specified value									
Leakage current (※ 2)	Less than or equal to the initial specified value									
Marking	Navy blue print on the case top									

- ※ 1 ESR should be measured at both of the terminal ends closest where the terminals protrude through the plastic platform.
- ※ 2 Conditioning : If any doubt arises, measure the leakage current after the voltage treatment of applying DC rated voltage continuously to the capacitor for 120 minutes at 105°C.
- ※ 3 Initial value : The value before test of examination of resistance to soldering.

## Dimensions

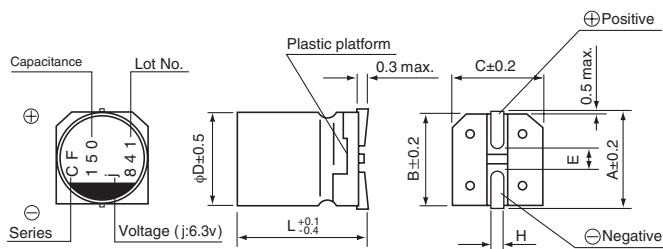

## Type numbering system (Example : 6.3V 150µF)

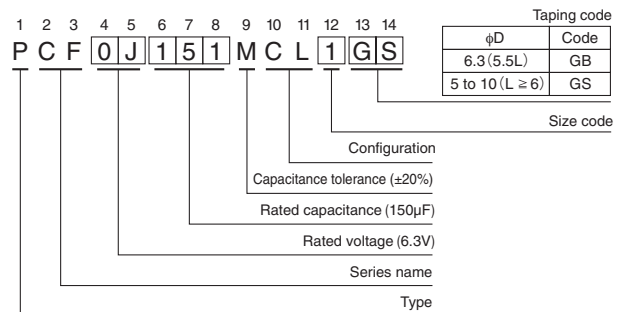

Size	φ5 × 6L	φ6.3 × 5.5L	φ6.3 × 6L	φ8 × 7L	φ8 × 12L	φ10 × 8L	φ10 × 10L	φ10 × 12.7L
φD	5.0	6.3	6.3	8.0	8.0	10.0	10.0	10.0
L	5.9	5.4	5.9	6.9	11.9	7.9	9.9	12.6
A	6.0	7.3	7.3	9.0	9.0	11.0	11.0	11.0
B	5.3	6.6	6.6	8.3	8.3	10.3	10.3	10.3
C	5.3	6.6	6.6	8.3	8.3	10.3	10.3	10.3
E	1.6	2.1	2.1	3.2	3.2	4.6	4.6	4.6
H	0.5 to 0.8	0.5 to 0.8	0.5 to 0.8	0.8 to 1.1	0.8 to 1.1	0.8 to 1.1	0.8 to 1.1	0.8 to 1.1

## Voltage

V	2.5	4	6.3	10	16	20	25
Code	e	g	j	A	C	D	E

## Frequency coefficient of rated ripple current

Frequency	120Hz	1kHz	10kHz	100kHz or more
Coefficient	0.05	0.30	0.70	1.00

● Dimension table in next page.

# PCF

## ■ Dimensions

Rated Voltage (V) (code)	Surge Voltage (V)	Rated Capacitance (μF)	Case Size φD × L (mm)	tan δ	Leakage Current (μA) (at 20°C after 2 minutes)	ESR (mΩ) (20°C/100kHz)	Rated Ripple (mA rms) (105°C/100kHz)	Part Number
2.5 (0E)	2.8	100	6.3 × 6	0.12	100	22	2600	PCF0E101MCL1GS
		220	■ 6.3 × 5.5	0.12	110	20	2800	PCF0E221MCL4GB
		220	6.3 × 6	0.12	110	20	2800	PCF0E221MCL1GS
		470	8 × 7	0.12	235	20	3300	PCF0E471MCL1GS
		820	10 × 8	0.12	410	17	4400	PCF0E821MCL1GS
		1500	10 × 10	0.12	750	13	4700	PCF0E152MCL1GS
		1500	● 10 × 12.7	0.12	750	12	5440	PCF0E152MCL9GS
4 (0G)	4.6	100	■ 6.3 × 5.5	0.12	100	22	2600	PCF0G101MCL4GB
		100	6.3 × 6	0.12	80	22	2600	PCF0G101MCL1GS
		150	■ 6.3 × 5.5	0.12	120	22	2800	PCF0G151MCL4GB
		150	▲ 5 × 6	0.12	300	30	2000	PCF0G151MCL6GS
		150	6.3 × 6	0.12	120	22	2800	PCF0G151MCL1GS
		220	8 × 7	0.12	176	21	3200	PCF0G221MCL1GS
		330	8 × 7	0.12	264	21	3400	PCF0G331MCL1GS
		470	10 × 8	0.12	376	17	4200	PCF0G471MCL1GS
		560	■ 8 × 12	0.12	448	13	4520	PCF0G561MCL4GS
		680	10 × 8	0.12	544	17	4400	PCF0G681MCL1GS
		820	10 × 10	0.12	656	13	4800	PCF0G821MCL1GS
		1200	10 × 12.7	0.12	960	10	5500	PCF0G122MCL1GS
6.3 (0J)	7.2	47	5 × 6	0.12	148	35	1600	PCF0J470MCL1GS
		82	■ 6.3 × 5.5	0.12	103	23	2600	PCF0J820MCL4GB
		82	6.3 × 6	0.12	103	23	2600	PCF0J820MCL1GS
		100	■ 6.3 × 5.5	0.12	126	23	2800	PCF0J101MCL4GB
		100	▲ 5 × 6	0.12	315	25	2200	PCF0J101MCL6GS
		100	6.3 × 6	0.12	126	23	2800	PCF0J101MCL1GS
		120	6.3 × 6	0.12	151	23	3000	PCF0J121MCL1GS
		150	8 × 7	0.12	189	22	3200	PCF0J151MCL1GS
		220	8 × 7	0.12	277	22	3400	PCF0J221MCL1GS
		330	10 × 8	0.12	416	18	4200	PCF0J331MCL1GS
		470	■ 8 × 12	0.12	592	12	5300	PCF0J471MCL4GS
		470	▲ 10 × 8	0.12	592	18	4300	PCF0J471MCL6GS
		470	10 × 10	0.12	592	16	4600	PCF0J471MCL1GS
		680	10 × 10	0.12	857	14	5000	PCF0J681MCL1GS
680	● 10 × 12.7	0.12	857	10	5500	PCF0J681MCL9GS		
820	10 × 12.7	0.12	1033	10	5800	PCF0J821MCL1GS		
10 (1A)	11.5	33	5 × 6	0.12	165	35	1500	PCF1A330MCL1GS
		47	▲ 5 × 6	0.12	235	26	2600	PCF1A470MCL6GS
		47	6.3 × 6	0.12	94	26	2600	PCF1A470MCL1GS
		56	■ 6.3 × 5.5	0.12	112	25	2500	PCF1A560MCL4GB
		56	6.3 × 6	0.12	112	25	2500	PCF1A560MCL1GS
		120	8 × 7	0.12	240	23	3000	PCF1A121MCL1GS
		150	▲ 8 × 7	0.12	300	23	3200	PCF1A151MCL6GS
		150	10 × 8	0.12	300	21	3300	PCF1A151MCL1GS
		270	■ 8 × 12	0.12	540	13	4500	PCF1A271MCL4GS
		270	10 × 8	0.12	540	20	3600	PCF1A271MCL1GS
		330	■ 8 × 12	0.12	660	14	4000	PCF1A331MCL4GS
		330	10 × 8	0.12	660	20	3700	PCF1A331MCL1GS
		470	10 × 10	0.12	940	16	4600	PCF1A471MCL1GS
		470	● 10 × 12.7	0.12	940	12	5300	PCF1A471MCL9GS
		560	10 × 10	0.12	1120	15	4800	PCF1A561MCL1GS
560	● 10 × 12.7	0.12	1120	13	5230	PCF1A561MCL9GS		

# PCF

■ Dimensions

Rated Voltage (V) (code)	Surge Voltage (V)	Rated Capacitance (μF)	Case Size φD × L (mm)	tan δ	Leakage Current (μA) (at 20°C after 2 minutes)	ESR (mΩ) (20°C/100kHz)	Rated Ripple (mA <sub>rms</sub> ) (105°C/100kHz)	Part Number
16 (1C)	18.4	22	5 × 6	0.12	176	45	1210	PCF1C220MCL1GS
		33	6.3 × 6	0.12	106	31	2400	PCF1C330MCL1GS
		39	■ 6.3 × 5.5	0.12	125	31	2400	PCF1C390MCL4GB
		39	6.3 × 6	0.12	125	31	2400	PCF1C390MCL1GS
		56	8 × 7	0.12	179	30	2900	PCF1C560MCL1GS
		82	8 × 7	0.12	262	28	3200	PCF1C820MCL1GS
		100	10 × 8	0.12	320	27	3300	PCF1C101MCL1GS
		150	10 × 8	0.12	480	25	3500	PCF1C151MCL1GS
		180	■ 8 × 12	0.12	576	16	4400	PCF1C181MCL4GS
		180	10 × 8	0.12	576	25	3600	PCF1C181MCL1GS
		220	10 × 10	0.12	704	20	3900	PCF1C221MCL1GS
220	● 10 × 12.7	0.12	704	14	5050	PCF1C221MCL9GS		
330	10 × 12.7	0.12	1056	14	5000	PCF1C331MCL1GS		
20 (1D)	23	10	5 × 6	0.12	100	120	900	PCF1D100MCL1GS
		22	■ 6.3 × 5.5	0.12	100	50	1700	PCF1D220MCL4GB
		22	6.3 × 6	0.12	88	50	1700	PCF1D220MCL1GS
		39	8 × 7	0.12	156	45	2000	PCF1D390MCL1GS
		47	8 × 7	0.12	188	45	2000	PCF1D470MCL1GS
		56	10 × 8	0.12	224	40	2400	PCF1D560MCL1GS
		68	10 × 8	0.12	272	40	2600	PCF1D680MCL1GS
		82	10 × 8	0.12	328	40	2600	PCF1D820MCL1GS
		100	8 × 12	0.12	400	22	3200	PCF1D101MCL1GS
		120	10 × 10	0.12	480	35	2800	PCF1D121MCL1GS
		150	10 × 12.7	0.12	600	20	4320	PCF1D151MCL1GS
25 (1E)	28.7	6.8	6.3 × 6	0.12	85	80	1200	PCF1E6R8MCL1GS
		10	8 × 7	0.12	125	60	1600	PCF1E100MCL1GS
		22	10 × 8	0.12	275	50	2200	PCF1E220MCL1GS
		33	8 × 12	0.12	413	30	2800	PCF1E330MCL1GS
		47	■ 8 × 12	0.12	588	30	3000	PCF1E470MCL4GS
		47	10 × 10	0.12	588	45	2400	PCF1E470MCL1GS
		56	10 × 12.7	0.12	700	28	3800	PCF1E560MCL1GS

No marked, [1] will be put at 12th digit of type numbering system.  
 ■ : In this case, [4] will be put at 12th digit of type numbering system.  
 ▲ : In this case, [6] will be put at 12th digit of type numbering system.  
 ● : In this case, [9] will be put at 12th digit of type numbering system.

• For taping specifications, recommended land size/soldering by reflow and minimum order quantity, please refer to the Guidelines for Aluminum Electrolytic Capacitors.



Chip Type, Low ESR,  
Higher Capacitance



- Low ESR, Higher Capacitance, High ripple current.
- Load life of 2000 hours at 105°C.
- SMD type : Lead free reflow soldering condition at 260°C peak correspondence.
- Compliant to the RoHS directive (2011/65/EU,(EU)2015/863).
- AEC-Q200 Qualified. Please contact us for details.

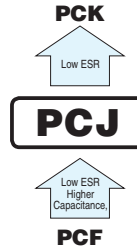

■ Specifications

Item	Performance Characteristics									
Category Temperature Range	-55 to +105°C									
Rated Voltage Range	2.5 to 16V									
Rated Capacitance Range	33 to 2700µF									
Capacitance Tolerance	±20% at 120Hz, 20°C									
Tangent of loss angle (tan δ)	Less than or equal to the specified value at 120Hz, 20°C									
ESR (※ 1)	Less than or equal to the specified value at 100kHz, 20°C									
Leakage Current (※ 2)	Less than or equal to the specified value . After 2 minutes' application of rated voltage at 20°C									
Temperature Characteristics (Max.Impedance Ratio)	$Z(+105^{\circ}\text{C}) / Z(+20^{\circ}\text{C}) \leq 1.25$ (100kHz) $Z(-55^{\circ}\text{C}) / Z(+20^{\circ}\text{C}) \leq 1.25$									
Endurance	The specifications listed at right shall be met when the capacitors are restored to 20°C after the rated voltage is applied for 2000 hours at 105°C.	<table border="1"> <tr><td>Capacitance change</td><td>Within ± 20% of the initial capacitance value (※ 3)</td></tr> <tr><td>tan δ</td><td>150% or less than the initial specified value</td></tr> <tr><td>ESR (※ 1)</td><td>150% or less than the initial specified value</td></tr> <tr><td>Leakage current (※ 2)</td><td>Less than or equal to the initial specified value</td></tr> </table>	Capacitance change	Within ± 20% of the initial capacitance value (※ 3)	tan δ	150% or less than the initial specified value	ESR (※ 1)	150% or less than the initial specified value	Leakage current (※ 2)	Less than or equal to the initial specified value
Capacitance change	Within ± 20% of the initial capacitance value (※ 3)									
tan δ	150% or less than the initial specified value									
ESR (※ 1)	150% or less than the initial specified value									
Leakage current (※ 2)	Less than or equal to the initial specified value									
Damp Heat (Steady State)	The specifications listed at right shall be met when the capacitors are restored to 20°C after the rated voltage is applied for 1000 hours at 60°C, 90% RH.	<table border="1"> <tr><td>Capacitance change</td><td>Within ± 20% of the initial capacitance value (※ 3)</td></tr> <tr><td>tan δ</td><td>150% or less than the initial specified value</td></tr> <tr><td>ESR (※ 1)</td><td>150% or less than the initial specified value</td></tr> <tr><td>Leakage current (※ 2)</td><td>Less than or equal to the initial specified value</td></tr> </table>	Capacitance change	Within ± 20% of the initial capacitance value (※ 3)	tan δ	150% or less than the initial specified value	ESR (※ 1)	150% or less than the initial specified value	Leakage current (※ 2)	Less than or equal to the initial specified value
Capacitance change	Within ± 20% of the initial capacitance value (※ 3)									
tan δ	150% or less than the initial specified value									
ESR (※ 1)	150% or less than the initial specified value									
Leakage current (※ 2)	Less than or equal to the initial specified value									
Resistance to Soldering Heat	After soldering the capacitor under the soldering conditions prescribed here, the capacitor shall meet the specifications listed at right. Pre-heating shall be done at 150 to 200°C and for 60 to 180 sec. The duration for over +230°C temperature at capacitor surface shall not exceed 60 seconds. In case peak temperature is 250°C or less, reflow soldering shall be two times maximum. In case peak temperature is 260°C or less, reflow soldering shall be once. Measurement for solder temperature profile shall be made at the capacitor top.	<table border="1"> <tr><td>Capacitance change</td><td>Within ± 10% of the initial capacitance value (※ 3)</td></tr> <tr><td>tan δ</td><td>130% or less than the initial specified value</td></tr> <tr><td>ESR (※ 1)</td><td>130% or less than the initial specified value</td></tr> <tr><td>Leakage current (※ 2)</td><td>Less than or equal to the initial specified value</td></tr> </table>	Capacitance change	Within ± 10% of the initial capacitance value (※ 3)	tan δ	130% or less than the initial specified value	ESR (※ 1)	130% or less than the initial specified value	Leakage current (※ 2)	Less than or equal to the initial specified value
Capacitance change	Within ± 10% of the initial capacitance value (※ 3)									
tan δ	130% or less than the initial specified value									
ESR (※ 1)	130% or less than the initial specified value									
Leakage current (※ 2)	Less than or equal to the initial specified value									
Marking	Navy blue print on the case top									

- ※ 1 ESR should be measured at both of the terminal ends closest where the terminals protrude through the plastic platform.
- ※ 2 Conditioning : If any doubt arises, measure the leakage current after the voltage treatment of applying DC rated voltage continuously to the capacitor for 120 minutes at 105°C.
- ※ 3 Initial value : The value before test of examination of resistance to soldering.

■ Dimensions

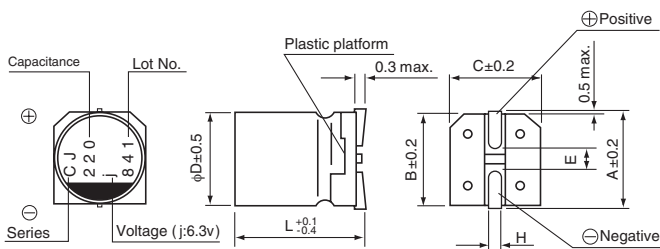

Type numbering system (Example : 6.3V 220µF)

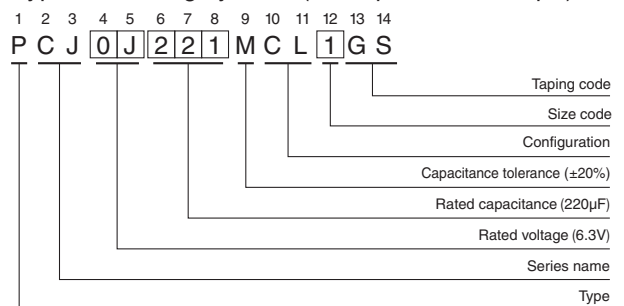

Size	φ5 × 6L	φ6.3 × 6L	φ6.3 × 8L	φ8 × 7L	φ8 × 8L	φ8 × 10L	φ8 × 12L	φ10 × 8L	φ10 × 10L	φ10 × 12.7L
φD	5.0	6.3	6.3	8.0	8.0	8.0	8.0	10.0	10.0	10.0
L	5.9	5.9	7.9	6.9	7.9	9.9	11.9	7.9	9.9	12.6
A	6.0	7.3	7.3	9.0	9.0	9.0	9.0	11.0	11.0	11.0
B	5.3	6.6	6.6	8.3	8.3	8.3	8.3	10.3	10.3	10.3
C	5.3	6.6	6.6	8.3	8.3	8.3	8.3	10.3	10.3	10.3
E	1.6	2.1	2.1	3.2	3.2	3.2	3.2	4.6	4.6	4.6
H	0.5 to 0.8	0.5 to 0.8	0.5 to 0.8	0.8 to 1.1	0.8 to 1.1	0.8 to 1.1	0.8 to 1.1	0.8 to 1.1	0.8 to 1.1	0.8 to 1.1

Voltage

V	2.5	4	6.3	10	16
Code	e	g	j	A	C

● Frequency coefficient of rated ripple current

Frequency	120Hz	1kHz	10kHz	100kHz or more
Coefficient	0.05	0.30	0.70	1.00

● Dimension table in next page.

CAT.8100M



■ Dimensions

Rated Voltage (V) (code)	Surge Voltage (V)	Rated Capacitance (μF)	Case Size φD × L (mm)	tan δ	Leakage Current (μA) (at 20°C after 2 minutes)	ESR (mΩ) (20°C/100kHz)	Rated Ripple (mA <sub>rms</sub> ) (105°C/100kHz)	Part Number
2.5 (0E)	2.8	180	5 × 6	0.12	90	21	2670	PCJ0E181MCL1GS
		390	6.3 × 6	0.12	195	15	3400	PCJ0E391MCL1GS
		470	6.3 × 8	0.12	235	13	3600	PCJ0E471MCL1GS
		560	■ 6.3 × 8	0.12	280	13	3600	PCJ0E561MCL4GS
		560	8 × 7	0.12	280	13	4100	PCJ0E561MCL1GS
		680	8 × 7	0.12	340	13	4100	PCJ0E681MCL1GS
		820	▲ 8 × 8	0.12	410	12	4260	PCJ0E821MCL6GS
		820	8 × 12	0.12	410	9	5400	PCJ0E821MCL1GS
		1000	8 × 8	0.12	500	12	4260	PCJ0E102MCL1GS
		1200	10 × 8	0.12	600	13	4800	PCJ0E122MCL1GS
		1500	▲ 8 × 10	0.12	750	10	5220	PCJ0E152MCL6GS
		1500	8 × 12	0.12	750	9	5400	PCJ0E152MCL1GS
		2200	10 × 10	0.12	1100	10	5500	PCJ0E222MCL1GS
		2700	10 × 12.7	0.12	1350	9	5800	PCJ0E272MCL1GS
4 (0G)	4.6	100	5 × 6	0.12	80	22	2610	PCJ0G101MCL1GS
		150	5 × 6	0.12	120	22	2610	PCJ0G151MCL1GS
		270	6.3 × 6	0.12	216	15	3200	PCJ0G271MCL1GS
		330	6.3 × 6	0.12	264	15	3300	PCJ0G331MCL1GS
		390	6.3 × 8	0.12	312	14	3470	PCJ0G391MCL1GS
		470	8 × 7	0.12	376	14	3950	PCJ0G471MCL1GS
		560	8 × 7	0.12	448	14	4000	PCJ0G561MCL1GS
		560	● 8 × 12	0.12	448	9	5200	PCJ0G561MCL9GS
		680	8 × 8	0.12	544	13	3950	PCJ0G681MCL1GS
		1000	■ 8 × 10	0.12	800	10	5220	PCJ0G102MCL4GS
		1000	10 × 8	0.12	800	13	4300	PCJ0G102MCL1GS
		1200	8 × 12	0.12	960	9	5400	PCJ0G122MCL1GS
		1200	▲ 10 × 10	0.12	960	10	5500	PCJ0G122MCL6GS
		1500	■ 8 × 12	0.12	1200	9	5200	PCJ0G152MCL4GS
		1500	10 × 10	0.12	1200	10	5500	PCJ0G152MCL1GS
		1800	10 × 10	0.12	1440	10	5500	PCJ0G182MCL1GS
		1800	● 10 × 12.7	0.12	1440	9	5600	PCJ0G182MCL9GS
2200	10 × 12.7	0.12	1760	9	5700	PCJ0G222MCL1GS		
6.3 (0J)	7.2	100	5 × 6	0.12	126	24	2500	PCJ0J101MCL1GS
		120	5 × 6	0.12	151	24	2500	PCJ0J121MCL1GS
		220	6.3 × 6	0.12	277	15	3200	PCJ0J221MCL1GS
		270	6.3 × 8	0.12	340	14	3470	PCJ0J271MCL1GS
		330	■ 6.3 × 8	0.12	416	14	3470	PCJ0J331MCL4GS
		330	8 × 7	0.12	416	14	3950	PCJ0J331MCL1GS
		390	8 × 7	0.12	491	14	3950	PCJ0J391MCL1GS
		470	8 × 8	0.12	592	13	3950	PCJ0J471MCL1GS
		820	▲ 8 × 10	0.12	1033	12	4770	PCJ0J821MCL6GS
		820	■ 8 × 12	0.12	1033	10	5150	PCJ0J821MCL4GS
		820	10 × 8	0.12	1033	13	4500	PCJ0J821MCL1GS
		1200	10 × 10	0.12	1512	12	5025	PCJ0J122MCL1GS
		1500	10 × 10	0.12	1890	12	5025	PCJ0J152MCL1GS
		1500	● 10 × 12.7	0.12	1890	10	5500	PCJ0J152MCL9GS
1800	10 × 12.7	0.12	2268	11	5200	PCJ0J182MCL1GS		
10 (1A)	11.5	47	5 × 6	0.12	94	28	2310	PCJ1A470MCL1GS
		56	5 × 6	0.12	112	28	2310	PCJ1A560MCL1GS
		68	5 × 6	0.12	136	28	2310	PCJ1A680MCL1GS
		120	6.3 × 6	0.12	240	25	2530	PCJ1A121MCL1GS
		150	6.3 × 8	0.12	300	21	2880	PCJ1A151MCL1GS
		220	8 × 7	0.12	440	21	3220	PCJ1A221MCL1GS
		270	8 × 7	0.12	540	21	3220	PCJ1A271MCL1GS
		330	8 × 8	0.12	660	19	3390	PCJ1A331MCL1GS
		390	8 × 10	0.12	780	17	4000	PCJ1A391MCL1GS
		470	10 × 8	0.12	940	19	3800	PCJ1A471MCL1GS
680	10 × 10	0.12	1360	13	4820	PCJ1A681MCL1GS		
16 (1C)	18.4	33	5 × 6	0.12	105	35	2070	PCJ1C330MCL1GS
		39	5 × 6	0.12	125	35	2070	PCJ1C390MCL1GS
		68	6.3 × 6	0.12	217	28	2390	PCJ1C680MCL1GS
		82	6.3 × 8	0.12	262	24	2700	PCJ1C820MCL1GS
		100	■ 6.3 × 8	0.12	320	24	2700	PCJ1C101MCL4GS
		100	8 × 7	0.12	320	24	3010	PCJ1C101MCL1GS
		120	8 × 7	0.12	384	24	3010	PCJ1C121MCL1GS
		150	8 × 8	0.12	480	22	3150	PCJ1C151MCL1GS
		180	8 × 10	0.12	576	18	3890	PCJ1C181MCL1GS
		220	■ 8 × 10	0.12	704	18	3890	PCJ1C221MCL4GS
		220	10 × 8	0.12	704	22	3450	PCJ1C221MCL1GS
		270	8 × 12	0.12	864	16	4070	PCJ1C271MCL1GS
330	10 × 10	0.12	1056	16	4350	PCJ1C331MCL1GS		

• For taping specifications, recommended land size/soldering by reflow and minimum order quantity, please refer to the Guidelines for Aluminum Electrolytic Capacitors.

No marked, [1] will be put at 12th digit of type numbering system.  
 ■ : In this case, [4] will be put at 12th digit of type numbering system.  
 ▲ : In this case, [6] will be put at 12th digit of type numbering system.  
 ● : In this case, [9] will be put at 12th digit of type numbering system.

**PCK**

Chip Type, Ultra-low ESR



- Ultra-low ESR, Higher Capacitance, High ripple current.
- Load life of 2000 hours at 105°C.
- SMD type : Lead free reflow soldering condition at 260°C peak correspondence.
- Compliant to the RoHS directive (2011/65/EU,(EU)2015/863).
- AEC-Q200 Qualified. Please contact us for details.

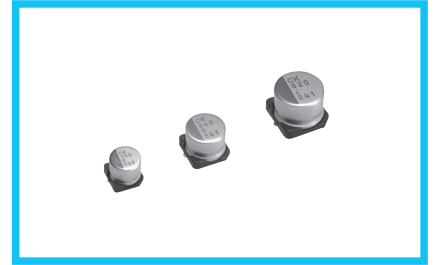

■ Specifications

Item	Performance Characteristics		
Category Temperature Range	-55 to +105°C		
Rated Voltage Range	2.5 to 6.3V		
Rated Capacitance Range	220 to 2200µF		
Capacitance Tolerance	±20% at 120Hz, 20°C		
Tangent of loss angle (tan δ)	Less than or equal to the specified value at 120Hz, 20°C		
ESR (※ 1)	Less than or equal to the specified value at 100kHz, 20°C		
Leakage Current (※ 2)	Less than or equal to the specified value . After 2 minutes' application of rated voltage at 20°C		
Temperature Characteristics (Max.Impedance Ratio)	Z(+105°C) / Z(+20°C) ≤ 1.25 (100kHz) Z(-55°C) / Z(+20°C) ≤ 1.25		
Endurance	The specifications listed at right shall be met when the capacitors are restored to 20°C after the rated voltage is applied for 2000 hours at 105°C.	Capacitance change	Within ± 20% of the initial capacitance value (※ 3)
		tan δ	150% or less than the initial specified value
		ESR (※ 1)	150% or less than the initial specified value
		Leakage current (※ 2)	Less than or equal to the initial specified value
Damp Heat (Steady State)	The specifications listed at right shall be met when the capacitors are restored to 20°C after the rated voltage is applied for 1000 hours at 60°C, 90% RH.	Capacitance change	Within ± 20% of the initial capacitance value (※ 3)
		tan δ	150% or less than the initial specified value
		ESR (※ 1)	150% or less than the initial specified value
		Leakage current (※ 2)	Less than or equal to the initial specified value
Resistance to Soldering Heat	After soldering the capacitor under the soldering conditions prescribed here, the capacitor shall meet the specifications listed at right. Pre-heating shall be done at 150 to 200°C and for 60 to 180 sec. The duration for over +230°C temperature at capacitor surface shall not exceed 60 seconds. In case peak temperature is 250°C or less, reflow soldering shall be two times maximum. In case peak temperature is 260°C or less, reflow soldering shall be once. Measurement for solder temperature profile shall be made at the capacitor top.	Capacitance change	Within ± 10% of the initial capacitance value (※ 3)
		tan δ	130% or less than the initial specified value
		ESR (※ 1)	130% or less than the initial specified value
		Leakage current (※ 2)	Less than or equal to the initial specified value
Marking	Navy blue print on the case top		

- ※ 1 ESR should be measured at both of the terminal ends closest where the terminals protrude through the plastic platform.
- ※ 2 Conditioning : If any doubt arises, measure the leakage current after the voltage treatment of applying DC rated voltage continuously to the capacitor for 120 minutes at 105°C.
- ※ 3 Initial value : The value before test of examination of resistance to soldering.

■ Dimensions

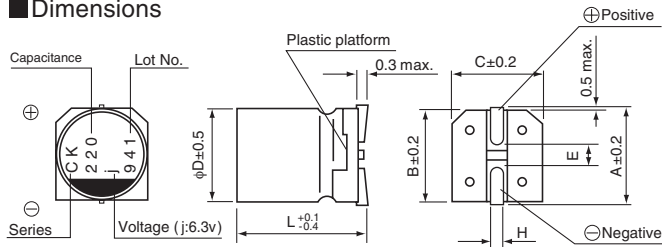

	(mm)			
Size	φ6.3 × 6L	φ8 × 7L	φ10 × 8L	φ10 × 10L
φD	6.3	8.0	10.0	10.0
L	5.9	6.9	7.9	9.9
A	7.3	9.0	11.0	11.0
B	6.6	8.3	10.3	10.3
C	6.6	8.3	10.3	10.3
E	2.1	3.2	4.6	4.6
H	0.5 to 0.8	0.8 to 1.1	0.8 to 1.1	0.8 to 1.1

Voltage			
V	2.5	4	6.3
Code	e	g	j

Type numbering system (Example : 6.3V 220µF)

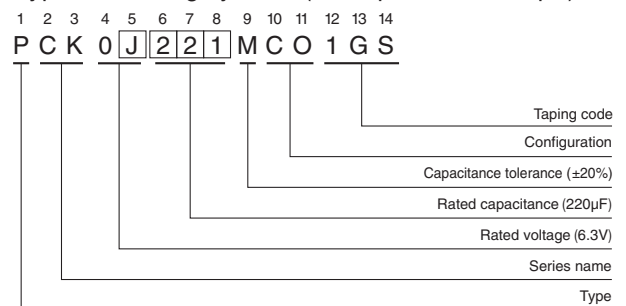

● Frequency coefficient of rated ripple current				
Frequency	120Hz	1kHz	10kHz	100kHz or more
Coefficient	0.05	0.30	0.70	1.00

● Dimension table in next page.

# PCK

■ Dimensions

Rated Voltage (V) (code)	Surge Voltage (V)	Rated Capacitance (μF)	Case Size φD × L (mm)	tan δ	Leakage Current (μA) (at 20°C after 2 minutes)	ESR (mΩ) (20°C/100kHz)	Rated Ripple (mArms) (105°C/100kHz)	Part Number
2.5 (0E)	2.8	390	6.3 × 6	0.12	293	10	3900	PCK0E391MCO1GS
		560	8 × 7	0.12	420	9	4500	PCK0E561MCO1GS
		680	8 × 7	0.12	510	9	4500	PCK0E681MCO1GS
		1200	10 × 8	0.12	900	9	5000	PCK0E122MCO1GS
		2200	10 × 10	0.12	1650	8	6000	PCK0E222MCO1GS
4 (0G)	4.6	330	6.3 × 6	0.12	396	10	3900	PCK0G331MCO1GS
		470	8 × 7	0.12	564	9	4500	PCK0G471MCO1GS
		560	8 × 7	0.12	672	9	4500	PCK0G561MCO1GS
		1000	10 × 8	0.12	1200	9	5000	PCK0G102MCO1GS
		1800	10 × 10	0.12	2160	8	6000	PCK0G182MCO1GS
6.3 (0J)	7.2	220	6.3 × 6	0.12	416	10	3900	PCK0J221MCO1GS
		330	8 × 7	0.12	624	9	4500	PCK0J331MCO1GS
		390	8 × 7	0.12	737	9	4500	PCK0J391MCO1GS
		820	10 × 8	0.12	1550	9	5000	PCK0J821MCO1GS
		1500	10 × 10	0.12	2835	8	6000	PCK0J152MCO1GS

• For taping specifications, recommended land size/soldering by reflow and minimum order quantity, please refer to the Guidelines for Aluminum Electrolytic Capacitors.

**PCG** Chip Type, Higher Capacitance



- Higher Capacitance, Low ESR, High ripple current.
- Load life of 2000 hours at 105°C.
- SMD type : Lead free reflow soldering condition at 260°C peak correspondence.
- Compliant to the RoHS directive (2011/65/EU,(EU)2015/863).
- AEC-Q200 Qualified. Please contact us for details.



■ Specifications

Item	Performance Characteristics		
Category Temperature Range	-55 to +105°C		
Rated Voltage Range	2.5 to 16V		
Rated Capacitance Range	47 to 4700µF		
Capacitance Tolerance	±20% at 120Hz, 20°C		
Tangent of loss angle (tan δ)	Less than or equal to the specified value at 120Hz, 20°C		
ESR (※ 1)	Less than or equal to the specified value at 100kHz, 20°C		
Leakage Current (※ 2)	Less than or equal to the specified value. After 2 minutes' application of rated voltage at 20°C		
Temperature Characteristics (Max.Impedance Ratio)	$Z(+105^{\circ}\text{C}) / Z(+20^{\circ}\text{C}) \leq 1.25$ (100kHz) $Z(-55^{\circ}\text{C}) / Z(+20^{\circ}\text{C}) \leq 1.25$		
Endurance	The specifications listed at right shall be met when the capacitors are restored to 20°C after the rated voltage is applied for 2000 hours at 105°C.	Capacitance change	Within ± 20% of the initial capacitance value (※ 3)
		tan δ	150% or less than the initial specified value
		ESR (※ 1)	150% or less than the initial specified value
		Leakage current (※ 2)	Less than or equal to the initial specified value
Damp Heat (Steady State)	The specifications listed at right shall be met when the capacitors are restored to 20°C after the rated voltage is applied for 1000 hours at 60°C, 90% RH.	Capacitance change	Within ± 20% of the initial capacitance value (※ 3)
		tan δ	150% or less than the initial specified value
		ESR (※ 1)	150% or less than the initial specified value
		Leakage current (※ 2)	Less than or equal to the initial specified value
Resistance to Soldering Heat	After soldering the capacitor under the soldering conditions prescribed here, the capacitor shall meet the specifications listed at right. Pre-heating shall be done at 150 to 200°C and for 60 to 180 sec. The duration for over +230°C temperature at capacitor surface shall not exceed 60 seconds. In case peak temperature is 250°C or less, reflow soldering shall be two times maximum. In case peak temperature is 260°C or less, reflow soldering shall be once. Measurement for solder temperature profile shall be made at the capacitor top.	Capacitance change	Within ± 10% of the initial capacitance value (※ 3)
		tan δ	130% or less than the initial specified value
		ESR (※ 1)	130% or less than the initial specified value
		Leakage current (※ 2)	Less than or equal to the initial specified value
Marking	Navy blue print on the case top		

- ※ 1 ESR should be measured at both of the terminal ends closest where the terminals protrude through the plastic platform.
- ※ 2 Conditioning : If any doubt arises, measure the leakage current after the voltage treatment of applying DC rated voltage continuously to the capacitor for 120 minutes at 105°C.
- ※ 3 Initial value : The value before test of examination of resistance to soldering.

■ Dimensions

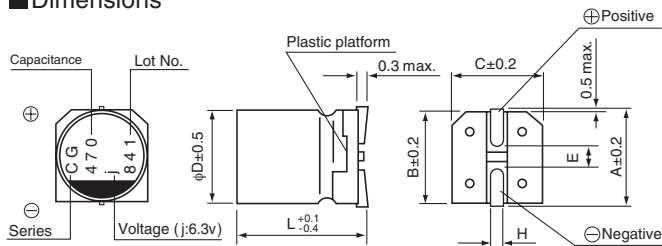

	(mm)					
Size	φ5 × 6L	φ6.3 × 6L	φ8 × 7L	φ10 × 8L	φ10 × 10L	φ10 × 12.7L
φD	5.0	6.3	8.0	10.0	10.0	10.0
L	5.9	5.9	6.9	7.9	9.9	12.6
A	6.0	7.3	9.0	11.0	11.0	11.0
B	5.3	6.6	8.3	10.3	10.3	10.3
C	5.3	6.6	8.3	10.3	10.3	10.3
E	1.6	2.1	3.2	4.6	4.6	4.6
H	0.5 to 0.8	0.5 to 0.8	0.8 to 1.1	0.8 to 1.1	0.8 to 1.1	0.8 to 1.1

● Dimension table in next page.

Type numbering system (Example : 6.3V 470µF)

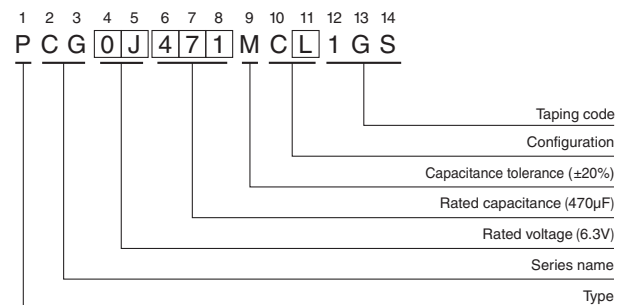

Voltage

V	2.5	4	6.3	10	16
Code	e	g	j	A	C

● Frequency coefficient of rated ripple current

Frequency	120Hz	1kHz	10kHz	100kHz or more
Coefficient	0.05	0.30	0.70	1.00





■ Dimensions

Rated Voltage (V) (code)	Surge Voltage (V)	Rated Capacitance (μF)	Case Size φD × L (mm)	tan δ	Leakage Current (μA) (at 20°C after 2 minutes)	ESR (mΩ) (20°C/100kHz)	Rated Ripple (mArms) (105°C/100kHz)	Part Number
2.5 (0E)	2.8	220	5 × 6	0.12	110	30	2100	PCG0E221MCL1GS
		330	5 × 6	0.12	500	30	2200	PCG0E331MCL1GS
		330	5 × 6	0.12	500	10	3300	PCG0E331MCO1GS
		470	6.3 × 6	0.12	235	20	2900	PCG0E471MCL1GS
		560	6.3 × 6	0.12	280	20	3000	PCG0E561MCL1GS
		820	8 × 7	0.12	410	20	3300	PCG0E821MCL1GS
		1500	10 × 8	0.12	750	17	4100	PCG0E152MCL1GS
		2700	10 × 10	0.12	1350	12	4700	PCG0E272MCL1GS
		3300	10 × 12.7	0.12	1650	10	5500	PCG0E332MCL1GS
		4700	10 × 12.7	0.12	2350	10	5600	PCG0E472MCL1GS
4 (0G)	4.6	180	5 × 6	0.12	144	32	1900	PCG0G181MCL1GS
		220	5 × 6	0.12	300	32	2000	PCG0G221MCL1GS
		220	5 × 6	0.12	300	15	2900	PCG0G221MCO1GS
		390	6.3 × 6	0.12	312	22	2700	PCG0G391MCL1GS
		680	8 × 7	0.12	544	21	3200	PCG0G681MCL1GS
		1200	10 × 8	0.12	960	17	4000	PCG0G122MCL1GS
		2200	10 × 10	0.12	1760	13	4600	PCG0G222MCL1GS
		2700	10 × 12.7	0.12	2160	11	5300	PCG0G272MCL1GS
		3300	10 × 12.7	0.12	2640	11	5400	PCG0G332MCL1GS
6.3 (0J)	7.2	150	5 × 6	0.12	189	33	1800	PCG0J151MCL1GS
		180	5 × 6	0.12	500	33	1900	PCG0J181MCL1GS
		180	5 × 6	0.12	500	17	3000	PCG0J181MCO1GS
		270	6.3 × 6	0.12	340	23	2600	PCG0J271MCL1GS
		330	6.3 × 6	0.12	416	23	2700	PCG0J331MCL1GS
		470	8 × 7	0.12	592	22	3100	PCG0J471MCL1GS
		1000	10 × 8	0.12	1260	18	3800	PCG0J102MCL1GS
		1800	10 × 10	0.12	2268	14	4400	PCG0J182MCL1GS
		2200	10 × 12.7	0.12	2772	12	5000	PCG0J222MCL1GS
2700	10 × 12.7	0.12	3402	12	5100	PCG0J272MCL1GS		
10 (1A)	11.5	82	5 × 6	0.12	164	35	1700	PCG1A820MCL1GS
		100	5 × 6	0.12	250	35	1800	PCG1A101MCL1GS
		150	6.3 × 6	0.12	300	25	2500	PCG1A151MCL1GS
		180	6.3 × 6	0.12	360	25	2600	PCG1A181MCL1GS
		330	8 × 7	0.12	660	23	3100	PCG1A331MCL1GS
		560	10 × 8	0.12	1120	20	3600	PCG1A561MCL1GS
		820	10 × 10	0.12	1640	15	4300	PCG1A821MCL1GS
		1000	10 × 12.7	0.12	2000	13	4800	PCG1A102MCL1GS
		1500	10 × 12.7	0.12	3000	13	4900	PCG1A152MCL1GS
16 (1C)	18.4	47	5 × 6	0.12	150	40	1500	PCG1C470MCL1GS
		56	5 × 6	0.12	240	40	1600	PCG1C560MCL1GS
		82	6.3 × 6	0.12	262	30	2300	PCG1C820MCL1GS
		100	6.3 × 6	0.12	320	30	2400	PCG1C101MCL1GS
		150	8 × 7	0.12	480	28	2800	PCG1C151MCL1GS
		270	10 × 8	0.12	864	25	3300	PCG1C271MCL1GS
		470	10 × 10	0.12	1504	20	3700	PCG1C471MCL1GS
		680	10 × 12.7	0.12	2176	18	4100	PCG1C681MCL1GS
		820	10 × 12.7	0.12	2624	18	4200	PCG1C821MCL1GS

• For taping specifications, recommended land size/soldering by reflow and minimum order quantity, please refer to the Guidelines for Aluminum Electrolytic Capacitors.



Chip Type, LongLife Assurance



- Load life of 5000 hours at 105°C.
- SMD type : Lead free reflow soldering condition at 260°C peak correspondence.
- Compliant to the RoHS directive (2011/65/EU,(EU)2015/863).
- AEC-Q200 Qualified. Please contact us for details.

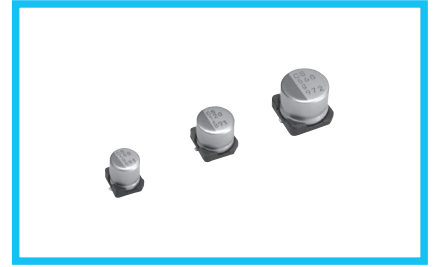

■ Specifications

Item	Performance Characteristics		
Category Temperature Range	-55 to +105°C		
Rated Voltage Range	4 to 16V		
Rated Capacitance Range	22 to 560μF		
Capacitance Tolerance	±20% at 120Hz, 20°C		
Tangent of loss angle (tan δ)	Less than or equal to the specified value at 120Hz, 20°C		
ESR (※ 1)	Less than or equal to the specified value at 100kHz, 20°C		
Leakage Current (※ 2)	Less than or equal to the specified value . After 2 minutes' application of rated voltage at 20°C		
Temperature Characteristics (Max.Impedance Ratio)	Z(+105°C) / Z(+20°C) ≤ 1.25 (100kHz) Z(-55°C) / Z(+20°C) ≤ 1.25		
Endurance	The specifications listed at right shall be met when the capacitors are restored to 20°C after the rated voltage is applied for 5000 hours at 105°C.	Capacitance change	Within ± 20% of the initial capacitance value (※ 3)
		tan δ	150% or less than the initial specified value
		ESR (※ 1)	150% or less than the initial specified value
		Leakage current (※ 2)	Less than or equal to the initial specified value
Damp Heat (Steady State)	The specifications listed at right shall be met when the capacitors are restored to 20°C after the rated voltage is applied for 1000 hours at 60°C, 90% RH.	Capacitance change	Within ± 20% of the initial capacitance value (※ 3)
		tan δ	150% or less than the initial specified value
		ESR (※ 1)	150% or less than the initial specified value
		Leakage current (※ 2)	Less than or equal to the initial specified value
Resistance to Soldering Heat	After soldering the capacitor under the soldering conditions prescribed here, the capacitor shall meet the specifications listed at right. Pre-heating shall be done at 150 to 200°C and for 60 to 180 sec. The duration for over +230°C temperature at capacitor surface shall not exceed 60 seconds. In case peak temperature is 250°C or less, reflow soldering shall be two times maximum. In case peak temperature is 260°C or less, reflow soldering shall be once. Measurement for solder temperature profile shall be made at the capacitor top.	Capacitance change	Within ± 10% of the initial capacitance value (※ 3)
		tan δ	130% or less than the initial specified value
		ESR (※ 1)	130% or less than the initial specified value
		Leakage current (※ 2)	Less than or equal to the initial specified value
Marking	Navy blue print on the case top		

- ※ 1 ESR should be measured at both of the terminal ends closest where the terminals protrude through the plastic platform.
- ※ 2 Conditioning : If any doubt arises, measure the leakage current after the voltage treatment of applying DC rated voltage continuously to the capacitor for 120 minutes at 105°C.
- ※ 3 Initial value : The value before test of examination of resistance to soldering.

■ Dimensions

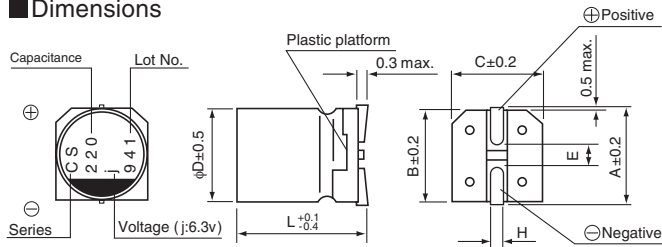

Size	(mm)		
	φ5 × 6L	φ6.3 × 6L	φ8 × 7L
φD	5.0	6.3	8.0
L	5.9	5.9	6.9
A	6.0	7.3	9.0
B	5.3	6.6	8.3
C	5.3	6.6	8.3
E	1.6	2.1	3.2
H	0.5 to 0.8	0.5 to 0.8	0.8 to 1.1

Voltage

V	4	6.3	10	16
Code	g	j	A	C

Type numbering system (Example : 6.3V 220μF)

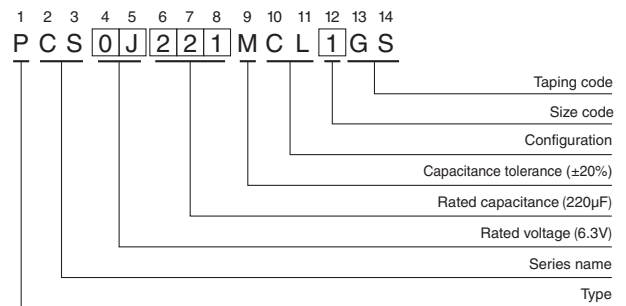

● Frequency coefficient of rated ripple current

Frequency	120Hz	1kHz	10kHz	100kHz or more
Coefficient	0.05	0.30	0.70	1.00

● Dimension table in next page.



■ Dimensions

Rated Voltage (V) (code)	Surge Voltage (V)	Rated Capacitance (μF)	Case Size φD × L (mm)	tan δ	Leakage Current (μA) (at 20°C after 2 minutes)	ESR (mΩ) (20°C/100kHz)	Rated Ripple (mA <sub>rms</sub> ) (105°C/100kHz)	Part Number
4 (0G)	4.6	150	5 × 6	0.12	120	25	2200	PCS0G151MCL1GS
		330	6.3 × 6	0.12	264	20	2800	PCS0G331MCL1GS
		330	● 8 × 7	0.12	264	22	3200	PCS0G331MCL9GS
		560	8 × 7	0.12	448	18	3600	PCS0G561MCL1GS
6.3 (0J)	7.2	47	5 × 6	0.12	100	35	1600	PCS0J470MCL1GS
		100	5 × 6	0.12	126	25	2400	PCS0J101MCL1GS
		100	● 6.3 × 6	0.12	126	22	2800	PCS0J101MCL9GS
		120	● 6.3 × 6	0.12	151	22	2800	PCS0J121MCL9GS
		220	6.3 × 6	0.12	277	20	2800	PCS0J221MCL1GS
		220	● 8 × 7	0.12	277	22	3200	PCS0J221MCL9GS
		390	8 × 7	0.12	491	22	3200	PCS0J391MCL1GS
10 (1A)	11.5	33	5 × 6	0.12	100	40	1300	PCS1A330MCL1GS
		56	● 6.3 × 6	0.12	112	27	2300	PCS1A560MCL9GS
		68	5 × 6	0.12	136	30	2100	PCS1A680MCL1GS
		120	6.3 × 6	0.12	240	27	2300	PCS1A121MCL1GS
		150	● 8 × 7	0.12	300	30	2600	PCS1A151MCL9GS
		270	8 × 7	0.12	540	22	3200	PCS1A271MCL1GS
16 (1C)	18.4	22	5 × 6	0.12	100	45	1100	PCS1C220MCL1GS
		39	5 × 6	0.12	125	35	2000	PCS1C390MCL1GS
		39	● 6.3 × 6	0.12	125	30	2200	PCS1C390MCL9GS
		68	6.3 × 6	0.12	218	30	2200	PCS1C680MCL1GS
		82	● 8 × 7	0.12	262	28	2800	PCS1C820MCL9GS
		120	8 × 7	0.12	384	28	2800	PCS1C121MCL1GS

No marked, [1] will be put at 12th digit of type numbering system.

● : In this case, [9] will be put at 12th digit of type numbering system.

• For taping specifications, recommended land size/soldering by reflow and minimum order quantity, please refer to the Guidelines for Aluminum Electrolytic Capacitors.



Chip Type, Higher Capacitance  
LongLife Assurance



- Long life of 20000 hours at 105°C.
- High reliability, Low ESR, High ripple current.
- SMD type : Lead free reflow soldering condition at 260°C peak correspondence.
- Compliant to the RoHS directive (2011/65/EU,(EU)2015/863).
- AEC-Q200 Qualified. Please contact us for details.



■ Specifications

Item	Performance Characteristics		
Category Temperature Range	-55 to +105°C		
Rated Voltage Range	2.5 to 25V		
Rated Capacitance Range	12 to 3300μF		
Capacitance Tolerance	±20% at 120Hz, 20°C		
Tangent of loss angle (tan δ)	Less than or equal to the specified value at 120Hz, 20°C		
ESR (※ 1)	Less than or equal to the specified value at 100kHz, 20°C		
Leakage Current (※ 2)	Less than or equal to the specified value . After 2 minutes' application of rated voltage at 20°C		
Temperature Characteristics (Max.Impedance Ratio)	$Z(+105^{\circ}\text{C}) / Z(+20^{\circ}\text{C}) \leq 1.25$ (100kHz) $Z(-55^{\circ}\text{C}) / Z(+20^{\circ}\text{C}) \leq 1.25$		
Endurance	The specifications listed at right shall be met when the capacitors are restored to 20°C after the rated voltage is applied for 20000 hours at 105°C.	Capacitance change	Within ± 20% of the initial capacitance value (※ 3)
		tan δ	150% or less than the initial specified value
		ESR (※ 1)	150% or less than the initial specified value
		Leakage current (※ 2)	Less than or equal to the initial specified value
Damp Heat (Steady State)	The specifications listed at right shall be met when the capacitors are restored to 20°C after the rated voltage is applied for 1000 hours at 60°C, 90% RH.	Capacitance change	Within ± 20% of the initial capacitance value (※ 3)
		tan δ	150% or less than the initial specified value
		ESR (※ 1)	150% or less than the initial specified value
		Leakage current (※ 2)	Less than or equal to the initial specified value
Resistance to Soldering Heat	After soldering the capacitor under the soldering conditions prescribed here, the capacitor shall meet the specifications listed at right. Pre-heating shall be done at 150 to 200°C and for 60 to 180 sec. The duration for over +230°C temperature at capacitor surface shall not exceed 60 seconds. In case peak temperature is 250°C or less, reflow soldering shall be two times maximum. In case peak temperature is 260°C or less, reflow soldering shall be once. Measurement for solder temperature profile shall be made at the capacitor top.	Capacitance change	Within ± 10% of the initial capacitance value (※ 3)
		tan δ	130% or less than the initial specified value
		ESR (※ 1)	130% or less than the initial specified value
		Leakage current (※ 2)	Less than or equal to the initial specified value
Marking	Navy blue print on the case top		

- ※ 1 ESR should be measured at both of the terminal ends closest where the terminals protrude through the plastic platform.
- ※ 2 Conditioning : If any doubt arises, measure the leakage current after the voltage treatment of applying DC rated voltage continuously to the capacitor for 120 minutes at 105°C.
- ※ 3 Initial value : The value before test of examination of resistance to soldering.

■ Dimensions

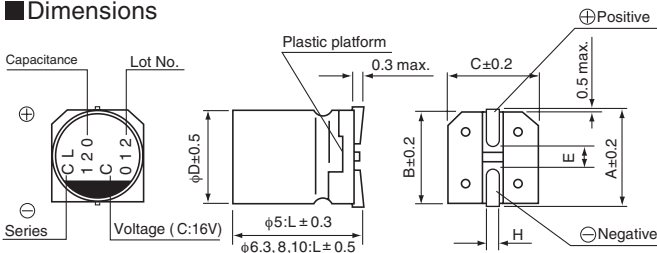

	(mm)						
Size	φ5 × 6L	φ6.3 × 6L	φ8 × 7L	φ8 × 10L	φ8 × 12L	φ10 × 10L	φ10 × 12.7L
φD	5.0	6.3	8.0	8.0	8.0	10.0	10.0
L	5.9	6.0	6.9	9.9	11.9	9.9	12.6
A	6.0	7.3	9.0	9.0	9.0	11.0	11.0
B	5.3	6.6	8.3	8.3	8.3	10.3	10.3
C	5.3	6.6	8.3	8.3	8.3	10.3	10.3
E	1.6	2.1	3.2	3.2	3.2	4.6	4.6
H	0.5 to 0.8	0.5 to 0.8	0.8 to 1.1	0.8 to 1.1	0.8 to 1.1	0.8 to 1.1	0.8 to 1.1

● Dimension table in next page.

Type numbering system (Example : 16V 120μF)

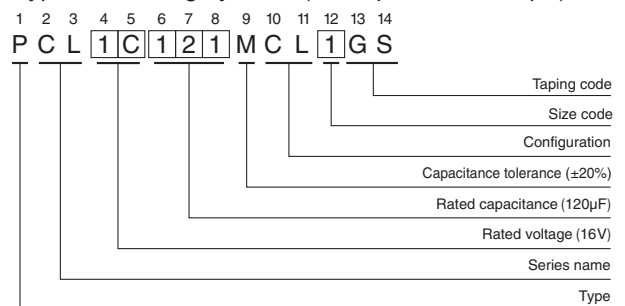

Voltage

V	2.5	4	6.3	10	16	20	25
Code	e	g	j	A	C	D	E

● Frequency coefficient of rated ripple current

Frequency	120Hz	1kHz	10kHz	100kHz or more
Coefficient	0.05	0.30	0.70	1.00



■ Dimensions

Rated Voltage (V) (code)	Surge Voltage (V)	Rated Capacitance (μF)	Case Size φD×L (mm)	tan δ	Leakage Current (μA) (at 20°C after 2 minutes)	ESR (mΩ) (20°C /100kHz)	Rated Ripple (mArms) (105°C /100kHz)	Part Number
2.5 (0E)	2.8	270	5×6	0.12	337	25	2670	PCL0E271MCL1GS
		2200	8×12	0.12	1100	14	5220	PCL0E222MCL1GS
		2700	10×10	0.12	1350	12	5500	PCL0E272MCL1GS
		3300	10×12.7	0.12	1650	11	5500	PCL0E332MCL1GS
4 (0G)	4.6	150	5×6	0.12	300	25	2100	PCL0G151MCL1GS
		180	5×6	0.12	360	25	2300	PCL0G181MCL1GS
		390	6.3×6	0.12	312	24	2700	PCL0G391MCL1GS
		560	8×7	0.12	448	22	3200	PCL0G561MCL1GS
		1200	8×10	0.12	960	15	5400	PCL0G122MCL1GS
		1800	8×12	0.12	1440	14	5500	PCL0G182MCL1GS
		2200	10×10	0.12	1760	12	5400	PCL0G222MCL1GS
6.3 (0J)	7.2	47	5×6	0.12	148	30	1900	PCL0J470MCL1GS
		220	6.3×6	0.12	277	22	2500	PCL0J221MCL1GS
		330	8×7	0.12	415	14	3900	PCL0J331MCL1GS
		680	8×10	0.12	856	12	4600	PCL0J681MCL1GS
		1000	8×12	0.12	1260	11	4800	PCL0J102MCL1GS
		1800	10×12.7	0.12	2268	10	5500	PCL0J182MCL1GS
10 (1A)	11.5	33	5×6	0.12	165	70	1100	PCL1A330MCL1GS
		68	5×6	0.12	340	30	1900	PCL1A680MCL1GS
		120	6.3×6	0.12	240	30	2700	PCL1A121MCL1GS
		150	8×7	0.12	300	21	2880	PCL1A151MCL1GS
		470	8×10	0.12	940	17	3800	PCL1A471MCL1GS
		820	10×10	0.12	1640	15	4300	PCL1A821MCL1GS
		1200	10×12.7	0.12	2400	13	4800	PCL1A122MCL1GS
16 (1C)	18.4	22	5×6	0.12	176	90	1000	PCL1C220MCL1GS
		39	6.3×6	0.12	124	37	2000	PCL1C390MCL1GS
		82	6.3×6	0.12	262	30	2700	PCL1C820MCL1GS
		120	8×7	0.12	384	27	2900	PCL1C121MCL1GS
		270	8×10	0.12	864	20	3600	PCL1C271MCL1GS
		390	8×12	0.12	1248	18	3900	PCL1C391MCL1GS
		470	10×10	0.12	1504	16	4200	PCL1C471MCL1GS
		680	10×12.7	0.12	2176	14	4700	PCL1C681MCL1GS
20 (1D)	23.0	27	6.3×6	0.12	108	60	1400	PCL1D270MCL1GS
		39	8×7	0.12	156	45	2000	PCL1D390MCL1GS
		100	8×12	0.12	400	22	3200	PCL1D101MCL1GS
		180	10×12.7	0.12	720	20	4300	PCL1D181MCL1GS
25 (1E)	28.7	12	6.3×6	0.12	100	70	1200	PCL1E120MCL1GS
		33	8×10	0.12	165	50	2000	PCL1E330MCL1GS
		56	10×10	0.12	280	45	2200	PCL1E560MCL1GS
		82	10×12.7	0.12	410	30	3800	PCL1E820MCL1GS

• For taping specifications, recommended land size/soldering by reflow and minimum order quantity, please refer to the Guidelines for Aluminum Electrolytic Capacitors.

**PCW**

Chip Type,  
125°C Reliability



For SMD



High Ripple Current



Low Impedance



For High Frequency

**NEW**



- Ripple Load Life of 2000h at 125°C.
- High reliability, Low ESR, High ripple current.
- SMD type : Lead free reflow soldering condition at 260°C peak complete correspondence.
- Compliant to the RoHS directive (2011/65/EU,(EU)2015/863).
- AEC-Q200 Qualified. Please contact us for details.

**PCW**

High temperature,  
Ripple current  
superimposition

**PCJ**

■ Specifications

Item	Performance Characteristics								
Category Temperature Range	-55 to +125°C								
Rated Voltage Range	2.5 to 6.3V								
Rated Capacitance Range	150 to 390µF								
Capacitance Tolerance	±20% at 120Hz, 20°C								
Tangent of loss angle (tan δ)	Less than or equal to the specified value at 120Hz, 20°C								
ESR (*1)	Less than or equal to the specified value at 100kHz, 20°C								
Leakage Current (*2)	Less than or equal to the specified value . After 2 minutes' application of rated voltage at 20°C								
Temperature Characteristics (Max.Impedance Ratio)	$Z(+125°C) / Z(+20°C) \leq 1.25$ (100kHz) $Z(-40°C) / Z(+20°C) \leq 1.25$								
Endurance	The specifications listed at right shall be met when the capacitors are restored to 20°C after D.C. bias plus rated ripple current is applied for 2000 hours at 125°C, the peak voltage shall not exceed the rated voltage. <table border="1" style="float: right;"> <tr><td>Capacitance change</td><td>Within ± 20% of the initial capacitance value (*3)</td></tr> <tr><td>tan δ</td><td>150% or less than the initial specified value</td></tr> <tr><td>ESR (*1)</td><td>150% or less than the initial specified value</td></tr> <tr><td>Leakage current (*2)</td><td>Less than or equal to the initial specified value</td></tr> </table>	Capacitance change	Within ± 20% of the initial capacitance value (*3)	tan δ	150% or less than the initial specified value	ESR (*1)	150% or less than the initial specified value	Leakage current (*2)	Less than or equal to the initial specified value
Capacitance change	Within ± 20% of the initial capacitance value (*3)								
tan δ	150% or less than the initial specified value								
ESR (*1)	150% or less than the initial specified value								
Leakage current (*2)	Less than or equal to the initial specified value								
Damp Heat (Steady State)	The specifications listed at right shall be met when the capacitors are restored to 20°C after the rated voltage is applied for 1000 hours at 85°C, 85% RH. <table border="1" style="float: right;"> <tr><td>Capacitance change</td><td>Within ± 20% of the initial capacitance value (*3)</td></tr> <tr><td>tan δ</td><td>150% or less than the initial specified value</td></tr> <tr><td>ESR (*1)</td><td>150% or less than the initial specified value</td></tr> <tr><td>Leakage current (*2)</td><td>Less than or equal to the initial specified value</td></tr> </table>	Capacitance change	Within ± 20% of the initial capacitance value (*3)	tan δ	150% or less than the initial specified value	ESR (*1)	150% or less than the initial specified value	Leakage current (*2)	Less than or equal to the initial specified value
Capacitance change	Within ± 20% of the initial capacitance value (*3)								
tan δ	150% or less than the initial specified value								
ESR (*1)	150% or less than the initial specified value								
Leakage current (*2)	Less than or equal to the initial specified value								
Resistance to Soldering Heat	After soldering the capacitor under the soldering conditions prescribed here, the capacitor shall meet the specifications listed at right. Pre-heating shall be done at 150 to 200°C and for 60 to 180 sec. The duration for over +230°C temperature at capacitor surface shall not exceed 60 seconds. In case peak temperature is 250°C or less, reflow soldering shall be two times maximum. In case peak temperature is 260°C or less, reflow soldering shall be once. The temperature profile measurement shall be the temperature at the top of the capacitor. <table border="1" style="float: right;"> <tr><td>Capacitance change</td><td>Within ± 10% of the initial capacitance value (*3)</td></tr> <tr><td>tan δ</td><td>130% or less than the initial specified value</td></tr> <tr><td>ESR (*1)</td><td>130% or less than the initial specified value</td></tr> <tr><td>Leakage current (*2)</td><td>Less than or equal to the initial specified value</td></tr> </table>	Capacitance change	Within ± 10% of the initial capacitance value (*3)	tan δ	130% or less than the initial specified value	ESR (*1)	130% or less than the initial specified value	Leakage current (*2)	Less than or equal to the initial specified value
Capacitance change	Within ± 10% of the initial capacitance value (*3)								
tan δ	130% or less than the initial specified value								
ESR (*1)	130% or less than the initial specified value								
Leakage current (*2)	Less than or equal to the initial specified value								
Marking	Navy blue print on the case top								

- \*1 ESR should be measured at both of the terminal ends closest where the terminals protrude through the plastic platform.
- \*2 Conditioning : If any doubt arises, measure the leakage current after the voltage treatment of applying DC rated voltage continuously to the capacitor for 120 minutes at 105°C.
- \*3 Initial value : The value before test of examination of resistance to soldering.

■ Dimensions

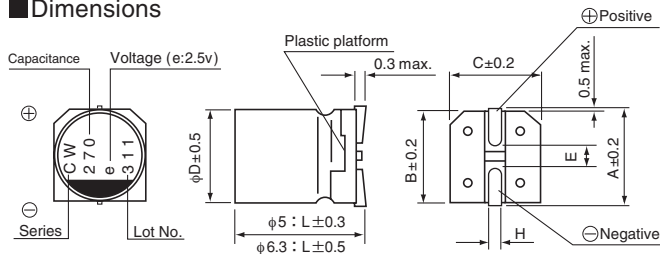

(mm)		
Size	φ5 × 6L	φ6.3 × 6L
φD	5.0	6.3
L	5.9	6.0
A	6.0	7.3
B	5.3	6.6
C	5.3	6.6
E	1.6	2.1
H	0.5 to 0.8	0.5 to 0.8

Voltage			
V	2.5	4	6.3
Code	e	g	j

Type numbering system (Example : 2.5V 270µF)

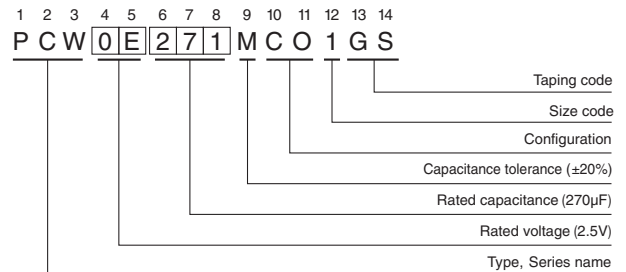

● Frequency coefficient of rated ripple current				
Frequency	120Hz	1kHz	10kHz	100kHz or more
Coefficient	0.05	0.30	0.70	1.00

● Dimension table in next page.

# PCW

■ Dimensions

Rated Voltage (V) (code)	Surge Voltage (V)	Rated Capacitance (μF)	Case Size φD×L (mm)	tan δ	Leakage Current (μA) (at 20°C after 2 minutes)	ESR (mΩ) (20°C /100kHz)	Rated Ripple (mArms) (125°C /100kHz)	Part Number
2.5 (0E)	2.8	270	5×6	0.08	270	16	1800	PCW0E271MCO1GS
		390	6.3×6	0.08	292	15	1890	PCW0E391MCO1GS
4 (0G)	4.6	180	5×6	0.08	288	17	1720	PCW0G181MCO1GS
		330	6.3×6	0.08	396	16	1800	PCW0G331MCO1GS
6.3 (0J)	7.2	150	5×6	0.08	378	18	1580	PCW0J151MCO1GS
		220	6.3×6	0.08	415	16	1800	PCW0J221MCO1GS

• For taping specifications, recommended land size/soldering by reflow and minimum order quantity, please refer to the Guidelines for Aluminum Electrolytic Capacitors.

**PCV** Chip Type, High Voltage / Long Life



- High voltage (to 125V), Low ESR, High ripple current.
- Load life of 3000 hours at 105°C.
- SMD type : Lead free reflow soldering condition at 260°C peak correspondence.
- Compliant to the RoHS directive (2011/65/EU,(EU)2015/863).
- AEC-Q200 Qualified. Please contact us for details.



PCV ← High Temperature → PCV

■ Specifications

Item	Performance Characteristics	
Category Temperature Range	-55 to +105°C	
Rated Voltage Range	16 to 125V	
Rated Capacitance Range	5.6 to 680μF	
Capacitance Tolerance	±20% at 120Hz, 20°C	
Tangent of loss angle (tan δ)	Less than or equal to the specified value at 120Hz, 20°C	
ESR (※ 1)	Less than or equal to the specified value at 100kHz, 20°C	
Leakage Current (※ 2)	Less than or equal to the specified value . After 2 minutes' application of rated voltage at 20°C	
Temperature Characteristics (Max.Impedance Ratio)	Z(+105°C) / Z(+20°C) ≤ 1.25 (100kHz) Z(-55°C) / Z(+20°C) ≤ 1.25	
Endurance	The specifications listed at right shall be met when the capacitors are restored to 20°C after the rated voltage is applied for 3000 hours at 105°C.	Capacitance change Within ± 20% of the initial capacitance value (※ 3)
		tan δ 150% or less than the initial specified value
		ESR (※ 1) 150% or less than the initial specified value
		Leakage current (※ 2) Less than or equal to the initial specified value
Damp Heat (Steady State)	The specifications listed at right shall be met when the capacitors are restored to 20°C after the rated voltage is applied for 1000 hours at 60°C, 90% RH.	Capacitance change Within ± 20% of the initial capacitance value (※ 3)
		tan δ 150% or less than the initial specified value
		ESR (※ 1) 150% or less than the initial specified value
		Leakage current (※ 2) Less than or equal to the initial specified value
Resistance to Soldering Heat	After soldering the capacitor under the soldering conditions prescribed here, the capacitor shall meet the specifications listed at right. Pre-heating shall be done at 150 to 200°C and for 60 to 180 sec. The duration for over +230°C temperature at capacitor surface shall not exceed 60 seconds. In case peak temperature is 250°C or less, reflow soldering shall be two times maximum. In case peak temperature is 260°C or less, reflow soldering shall be once. Measurement for solder temperature profile shall be made at the capacitor top.	Capacitance change Within ± 10% of the initial capacitance value (※ 3)
		tan δ 130% or less than the initial specified value
		ESR (※ 1) 130% or less than the initial specified value
		Leakage current (※ 2) Less than or equal to the initial specified value
Marking	Navy blue print on the case top	

- ※ 1 ESR should be measured at both of the terminal ends closest where the terminals protrude through the plastic platform.
- ※ 2 Conditioning : If any doubt arises, measure the leakage current after the voltage treatment of applying DC rated voltage continuously to the capacitor for 120 minutes at 105°C.
- ※ 3 Initial value : The value before test of examination of resistance to soldering.

■ Dimensions

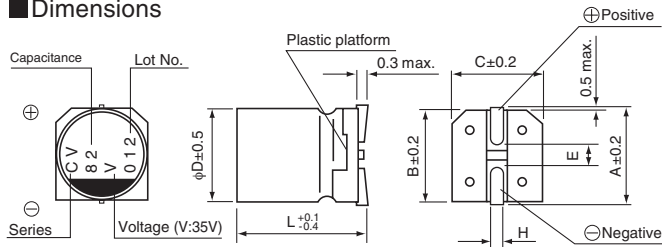

Type numbering system (Example : 35V 82μF)

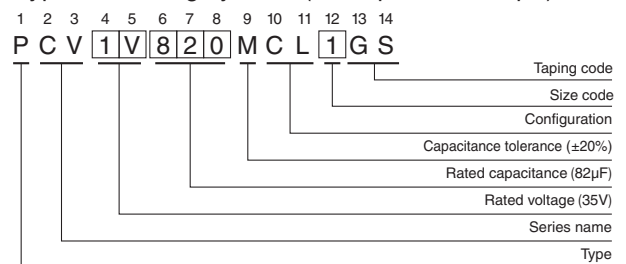

Size	φ6.3x6L	φ8x7L	φ8x10L	φ8x12L	φ10x8L	φ10x10L	φ10x12.7L
φD	6.3	8.0	8.0	8.0	10.0	10.0	10.0
L	5.9	6.9	9.9	11.9	7.9	9.9	12.6
A	7.3	9.0	9.0	9.0	11.0	11.0	11.0
B	6.6	8.3	8.3	8.3	10.3	10.3	10.3
C	6.6	8.3	8.3	8.3	10.3	10.3	10.3
E	2.1	3.2	3.2	3.2	4.6	4.6	4.6
H	0.5 to 0.8	0.8 to 1.1	0.8 to 1.1	0.8 to 1.1	0.8 to 1.1	0.8 to 1.1	0.8 to 1.1

Voltage

V	16	20	25	35	50	63	80	100	125
Code	C	D	E	V	H	J	K	2A	2B

● Frequency coefficient of rated ripple current

Frequency	120Hz	1kHz	10kHz	100kHz or more
Coefficient	0.05	0.30	0.70	1.00

● Dimension table in next page.





■ Dimensions

Rated Voltage (V) (code)	Surge Voltage (V)	Rated Capacitance (μF)	Case Size φD × L (mm)	tan δ	Leakage Current (μA) (at 20°C after 2 minutes)	ESR (mΩ) (20°C/100kHz)	Rated Ripple (mArms) (105°C/100kHz)	Part Number
16 (1C)	18.4	56	6.3 × 6	0.12	179	50	1000	PCV1C560MCL1GS
		82	△ 6.3 × 6	0.12	262	47	1300	PCV1C820MCL2GS
		100	8 × 7	0.12	320	36	1500	PCV1C101MCL1GS
		150	△ 8 × 7	0.12	480	34	1700	PCV1C151MCL2GS
		220	▲ 8 × 10	0.12	704	27	2000	PCV1C221MCL6GS
		220	10 × 8	0.12	704	31	2000	PCV1C221MCL1GS
		270	□ 8 × 10	0.12	864	21	3800	PCV1C271MCL7GS
		270	8 × 12	0.12	864	26	2300	PCV1C271MCL1GS
		270	△ 10 × 8	0.12	864	24	3200	PCV1C271MCL2GS
		330	10 × 10	0.12	1056	26	2400	PCV1C331MCL1GS
		390	△ 8 × 12	0.12	1248	20	4100	PCV1C391MCL2GS
		470	△ 10 × 10	0.12	1504	21	3900	PCV1C471MCL2GS
		470	10 × 12.7	0.12	1504	25	2800	PCV1C471MCL1GS
		680	△ 10 × 12.7	0.12	2176	19	4400	PCV1C681MCL2GS
20 (1D)	23.0	47	6.3 × 6	0.12	188	55	1000	PCV1D470MCL1GS
		56	△ 6.3 × 6	0.12	224	48	1300	PCV1D560MCL2GS
		68	8 × 7	0.12	272	45	1300	PCV1D680MCL1GS
		100	△ 8 × 7	0.12	400	42	1400	PCV1D101MCL2GS
		150	▲ 8 × 10	0.12	600	28	2000	PCV1D151MCL6GS
		150	10 × 8	0.12	600	33	1900	PCV1D151MCL1GS
		180	△ 10 × 8	0.12	720	25	3100	PCV1D181MCL2GS
		220	□ 8 × 10	0.12	880	22	3700	PCV1D221MCL7GS
		220	8 × 12	0.12	880	27	2300	PCV1D221MCL1GS
		270	△ 8 × 12	0.12	1080	21	4000	PCV1D271MCL2GS
		270	10 × 10	0.12	1080	27	2300	PCV1D271MCL1GS
		330	△ 10 × 10	0.12	1320	22	3800	PCV1D331MCL2GS
		330	10 × 12.7	0.12	1320	26	2700	PCV1D331MCL1GS
		470	△ 10 × 12.7	0.12	1880	20	4300	PCV1D471MCL2GS
25 (1E)	28.7	33	6.3 × 6	0.12	165	60	1000	PCV1E330MCL1GS
		47	△ 6.3 × 6	0.12	235	49	1300	PCV1E470MCL2GS
		56	8 × 7	0.12	280	50	1300	PCV1E560MCL1GS
		82	△ 8 × 7	0.12	410	47	1400	PCV1E820MCL2GS
		120	▲ 8 × 10	0.12	600	29	1900	PCV1E121MCL6GS
		120	10 × 8	0.12	600	35	1800	PCV1E121MCL1GS
		150	□ 8 × 10	0.12	750	23	3600	PCV1E151MCL7GS
		150	8 × 12	0.12	750	28	2200	PCV1E151MCL1GS
		150	△ 10 × 8	0.12	750	26	3000	PCV1E151MCL2GS
		180	10 × 10	0.12	900	28	2300	PCV1E181MCL1GS
		220	△ 8 × 12	0.12	1100	22	3800	PCV1E221MCL2GS
		270	△ 10 × 10	0.12	1350	23	3700	PCV1E271MCL2GS
		270	10 × 12.7	0.12	1350	27	2700	PCV1E271MCL1GS
		390	△ 10 × 12.7	0.12	1950	21	4200	PCV1E391MCL2GS
35 (1V)	40.2	18	6.3 × 6	0.12	126	64	900	PCV1V180MCL1GS
		22	△ 6.3 × 6	0.12	154	50	1300	PCV1V220MCL2GS
		27	8 × 7	0.12	189	55	1200	PCV1V270MCL1GS
		39	△ 8 × 7	0.12	273	52	1400	PCV1V390MCL2GS
		56	8 × 10	0.12	392	31	1900	PCV1V560MCL1GS
		68	10 × 8	0.12	476	37	1800	PCV1V680MCL1GS
		82	□ 8 × 10	0.12	574	24	3600	PCV1V820MCL7GS
		82	8 × 12	0.12	574	29	2200	PCV1V820MCL1GS
		82	△ 10 × 8	0.12	574	27	3000	PCV1V820MCL2GS
		100	10 × 10	0.12	700	29	2200	PCV1V101MCL1GS
		120	□ 8 × 12	0.12	840	23	3800	PCV1V121MCL7GS
		120	△ 10 × 10	0.12	840	24	3700	PCV1V121MCL2GS
		150	10 × 12.7	0.12	1050	28	2600	PCV1V151MCL1GS
		180	△ 10 × 12.7	0.12	1260	22	4100	PCV1V181MCL2GS



■ Dimensions

Rated Voltage (V) (code)	Surge Voltage (V)	Rated Capacitance (μF)	Case Size φD × L (mm)	tan δ	Leakage Current (μA) (at 20°C after 2 minutes)	ESR (mΩ) (20°C/100kHz)	Rated Ripple (mArms) (105°C/100kHz)	Part Number
50 (1H)	57.5	8.2	6.3×6	0.12	82	81	800	PCV1H8R2MCL1GS
		12	△ 6.3×6	0.12	120	55	1200	PCV1H120MCL2GS
		15	8×7	0.12	150	63	1100	PCV1H150MCL1GS
		22	△ 8×7	0.12	220	60	1300	PCV1H220MCL2GS
		33	▲ 8×10	0.12	330	36	1700	PCV1H330MCL6GS
		33	10×8	0.12	330	49	1500	PCV1H330MCL1GS
		39	8×12	0.12	390	34	2000	PCV1H390MCL1GS
		47	□ 8×10	0.12	470	29	3300	PCV1H470MCL7GS
		47	△ 10×8	0.12	470	37	2600	PCV1H470MCL2GS
		47	10×10	0.12	470	30	2200	PCV1H470MCL1GS
		56	△ 8×12	0.12	560	28	3400	PCV1H560MCL2GS
		68	△ 10×10	0.12	680	29	3400	PCV1H680MCL2GS
		68	10×12.7	0.12	680	29	2600	PCV1H680MCL1GS
100	△ 10×12.7	0.12	1000	27	3600	PCV1H101MCL2GS		
63 (1J)	72.4	5.6	6.3×6	0.12	71	105	700	PCV1J5R6MCL1GS
		8.2	△ 6.3×6	0.12	103	56	1200	PCV1J8R2MCL2GS
		10	8×7	0.12	126	75	1000	PCV1J100MCL1GS
		12	△ 8×7	0.12	151	70	1100	PCV1J120MCL2GS
		22	▲ 8×10	0.12	277	37	1700	PCV1J220MCL6GS
		22	10×8	0.12	277	56	1400	PCV1J220MCL1GS
		27	□ 8×10	0.12	340	30	3200	PCV1J270MCL7GS
		27	8×12	0.12	340	35	2000	PCV1J270MCL1GS
		27	△ 10×8	0.12	340	38	2500	PCV1J270MCL2GS
		33	10×10	0.12	416	31	2200	PCV1J330MCL1GS
		39	△ 8×12	0.12	491	29	3400	PCV1J390MCL2GS
		47	△ 10×10	0.12	592	30	3300	PCV1J470MCL2GS
		47	10×12.7	0.12	592	30	2500	PCV1J470MCL1GS
56	△ 10×12.7	0.12	706	28	3400	PCV1J560MCL2GS		
80 (1K)	92.0	10	8×10	0.12	160	43	1600	PCV1K100MCL1GS
		12	8×12	0.12	192	41	1800	PCV1K120MCL1GS
		15	10×10	0.12	240	39	1900	PCV1K150MCL1GS
		22	10×12.7	0.12	352	38	2200	PCV1K220MCL1GS
100 (2A)	115	6.8	8×10	0.12	136	48	1500	PCV2A6R8MCL1GS
		10	8×12	0.12	200	45	1700	PCV2A100MCL1GS
		12	10×10	0.12	240	42	1900	PCV2A120MCL1GS
		18	10×12.7	0.12	360	41	2100	PCV2A180MCL1GS
125 (2B)	143	6.8	8×10	0.12	170	93	1100	PCV2B6R8MCL1GS
		8.2	8×12	0.12	205	84	1300	PCV2B8R2MCL1GS
		12	10×10	0.12	300	69	1400	PCV2B120MCL1GS
		15	10×12.7	0.12	375	48	2000	PCV2B150MCL1GS

No marked, [1] will be put at 12th digit of type numbering system.  
 △ : In this case, [2] will be put at 12th digit of type numbering system.  
 ▲ : In this case, [6] will be put at 12th digit of type numbering system.  
 □ : In this case, [7] will be put at 12th digit of type numbering system.

• For taping specifications, recommended land size/soldering by reflow and minimum order quantity, please refer to the Guidelines for Aluminum Electrolytic Capacitors.

**PCX** Chip Type, High Voltage / Long Life



- High reliability, High voltage (to 50V).
- Low ESR, High ripple current.
- Long life of 1500 to 3000 hours at 125°C.
- SMD type : Lead free reflow soldering condition at 260°C peak complete correspondence.
- Compliant to the RoHS directive (2011/65/EU,(EU)2015/863).
- AEC-Q200 Qualified. Please contact us for details.

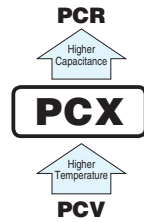

■ Specifications

Item	Performance Characteristics								
Category Temperature Range	-55 to +125°C								
Rated Voltage Range	16 to 50V								
Rated Capacitance Range	5.6 to 390µF								
Capacitance Tolerance	±20% at 120Hz, 20°C								
Tangent of loss angle (tan δ)	Less than or equal to the specified value at 120Hz, 20°C								
ESR (※ 1)	Less than or equal to the specified value at 100kHz, 20°C								
Leakage Current (※ 2)	Less than or equal to the specified value . After 2 minutes' application of rated voltage at 20°C								
Temperature Characteristics (Max.Impedance Ratio)	Z(+125°C) / Z(+20°C) ≤ 1.25 (100kHz) Z(-55°C) / Z(+20°C) ≤ 1.25								
Endurance	<p>The specifications listed at right shall be met when the capacitors are restored to 20°C after the rated voltage is applied for 3000 hours (φD = 6.3:1500hours) at 125°C.</p> <table border="1"> <tr><td>Capacitance change</td><td>Within ± 20% of initial capacitance value (※3)</td></tr> <tr><td>tan δ</td><td>150% or less of the initial specified value</td></tr> <tr><td>ESR (※ 1)</td><td>150% or less of the initial specified value</td></tr> <tr><td>Leakage current (※ 2)</td><td>Less than or equal to the initial specified value</td></tr> </table>	Capacitance change	Within ± 20% of initial capacitance value (※3)	tan δ	150% or less of the initial specified value	ESR (※ 1)	150% or less of the initial specified value	Leakage current (※ 2)	Less than or equal to the initial specified value
Capacitance change	Within ± 20% of initial capacitance value (※3)								
tan δ	150% or less of the initial specified value								
ESR (※ 1)	150% or less of the initial specified value								
Leakage current (※ 2)	Less than or equal to the initial specified value								
Damp Heat (Steady State)	<p>The specifications listed at right shall be met when the capacitors are restored to 20°C after the rated voltage is applied for 1000 hours at 60°C, 90% RH.</p> <table border="1"> <tr><td>Capacitance change</td><td>Within ± 20% of initial capacitance value (※3)</td></tr> <tr><td>tan δ</td><td>150% or less of the initial specified value</td></tr> <tr><td>ESR (※ 1)</td><td>150% or less of the initial specified value</td></tr> <tr><td>Leakage current (※ 2)</td><td>Less than or equal to the initial specified value</td></tr> </table>	Capacitance change	Within ± 20% of initial capacitance value (※3)	tan δ	150% or less of the initial specified value	ESR (※ 1)	150% or less of the initial specified value	Leakage current (※ 2)	Less than or equal to the initial specified value
Capacitance change	Within ± 20% of initial capacitance value (※3)								
tan δ	150% or less of the initial specified value								
ESR (※ 1)	150% or less of the initial specified value								
Leakage current (※ 2)	Less than or equal to the initial specified value								
Resistance to Soldering Heat	<p>After soldering the capacitor under the soldering conditions prescribed here, the capacitor shall meet the specifications listed at right. Pre-heating shall be done at 150 to 200°C and for 60 to 180 sec. The duration for over +230°C temperature at capacitor surface shall not exceed 60 seconds. In case peak temperature is 250°C or less, reflow soldering shall be two times maximum. In case peak temperature is 260°C or less, reflow soldering shall be once. Measurement for solder temperature profile shall be made at the capacitor top.</p> <table border="1"> <tr><td>Capacitance change</td><td>Within ± 10% of the initial capacitance value (※3)</td></tr> <tr><td>tan δ</td><td>130% or less than the initial specified value</td></tr> <tr><td>ESR (※ 1)</td><td>130% or less than the initial specified value</td></tr> <tr><td>Leakage current (※ 2)</td><td>Less than or equal to the initial specified value</td></tr> </table>	Capacitance change	Within ± 10% of the initial capacitance value (※3)	tan δ	130% or less than the initial specified value	ESR (※ 1)	130% or less than the initial specified value	Leakage current (※ 2)	Less than or equal to the initial specified value
Capacitance change	Within ± 10% of the initial capacitance value (※3)								
tan δ	130% or less than the initial specified value								
ESR (※ 1)	130% or less than the initial specified value								
Leakage current (※ 2)	Less than or equal to the initial specified value								
Marking	Navy blue print on the case top								

- ※ 1 ESR should be measured at both of the terminal ends closest where the terminals protrude through the plastic platform.
- ※ 2 Conditioning : If any doubt arises, measure the leakage current after the voltage treatment of applying DC rated voltage continuously to the capacitor for 120 minutes at 105°C.
- ※ 3 Initial value : The value before test of examination of resistance to soldering.

■ Dimensions

[Standard]

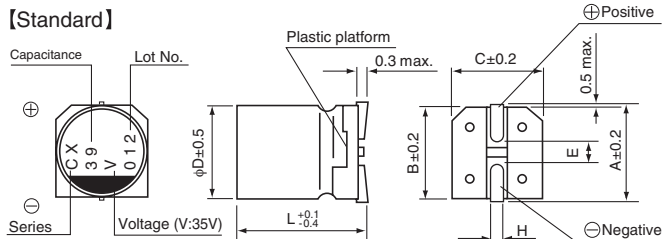

[Vibration Resistance]

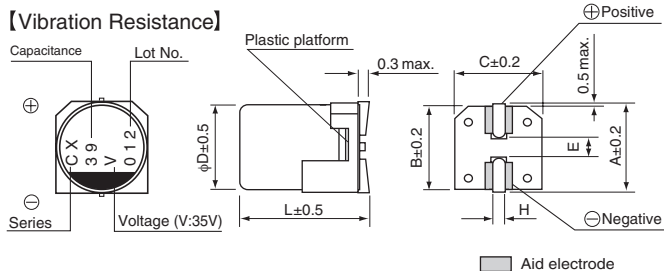

Type numbering system (Example : 35V 39µF)

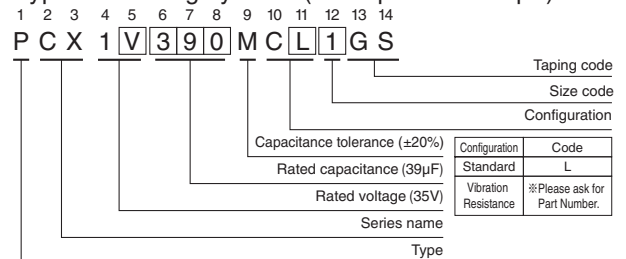

※ φ6.3×8L(φ6.3×8L),φ8×10L(φ8×10.5L),φ10×10L(φ10×10.5L),φ10×12.7L(φ10×13.2L) : The vibration structure-resistant product is also available upon request, please ask for details. ( ) : Size of the vibration structure-resistant product.

Standard		Vibration Resistance (mm)	
Size	φ6.3×6L φ6.3×8L φ8×7L φ8×10L φ8×12L φ10×8L φ10×10L φ10×12.7L	Size	φ6.3×8L φ8×10.5L φ10×13.2L
φD	6.3 6.3 8.0 8.0 8.0 10.0 10.0 10.0	φD	6.3 8.0 10.0 10.0
L	5.9 7.9 6.9 9.9 11.9 7.9 9.9 12.6	L	7.5 10.0 10.0 12.7
A	7.3 7.3 9.0 9.0 9.0 11.0 11.0 11.0	A	7.3 9.0 11.0 11.0
B	6.6 6.6 8.3 8.3 8.3 10.3 10.3 10.3	B	6.6 8.3 10.3 10.3
C	6.6 6.6 8.3 8.3 8.3 10.3 10.3 10.3	C	6.6 8.3 10.3 10.3
E	2.1 2.1 3.2 3.2 3.2 4.6 4.6 4.6	E	2.5 3.1 4.6 4.6
H	0.5 to 0.8 0.5 to 0.8 0.8 to 1.1 0.8 to 1.1 0.8 to 1.1 0.8 to 1.1 0.8 to 1.1 0.8 to 1.1	H	0.5 to 0.8 1.1 to 1.5 1.1 to 1.5 1.1 to 1.5

Voltage

V	16	20	25	35	50
Code	C	D	E	V	H

● Frequency coefficient of rated ripple current

Frequency	120Hz	1kHz	10kHz	100kHz or more
Coefficient	0.05	0.30	0.70	1.00

● Dimension table in next page.



■ Dimensions

Rated Voltage (V) (code)	Surge Voltage (V)	Rated Capacitance (μF)	Case Size φD×L (mm)	tan δ	Leakage Current (μA) (at 20°C after 2 minutes)	ESR (mΩ) (20°C/100kHz)	Rated Ripple (mArms/100kHz)		Part Number
							≤105°C (*3)	105°C < ≤125°C (*3)	
16 (1C)	18.4	47	6.3×6	0.12	150	55	1000	390	PCX1C470MCL1GS
		82	8×7	0.12	262	45	1300	530	PCX1C820MCL1GS
		100	6.3×8	0.12	320	33	1500	460	PCX1C101MCL1GS
		150	▲8×10	0.12	480	28	2000	780	PCX1C151MCL6GS
		150	10×8	0.12	480	33	1900	830	PCX1C151MCL1GS
		220	8×12	0.12	704	27	2300	870	PCX1C221MCL1GS
		270	10×10	0.12	864	27	2300	830	PCX1C271MCL1GS
		390	10×12.7	0.12	1248	26	2700	1040	PCX1C391MCL1GS
20 (1D)	23.0	33	6.3×6	0.12	132	60	900	380	PCX1D330MCL1GS
		56	8×7	0.12	224	50	1300	500	PCX1D560MCL1GS
		68	6.3×8	0.12	272	34	1450	470	PCX1D680MCL1GS
		120	▲8×10	0.12	480	29	1900	770	PCX1D121MCL6GS
		120	10×8	0.12	480	35	1800	810	PCX1D121MCL1GS
		150	8×12	0.12	600	28	2200	860	PCX1D151MCL1GS
		180	10×10	0.12	720	28	2300	800	PCX1D181MCL1GS
		270	10×12.7	0.12	1080	27	2700	1020	PCX1D271MCL1GS
25 (1E)	28.7	22	6.3×6	0.12	110	65	900	360	PCX1E220MCL1GS
		39	8×7	0.12	195	55	1200	480	PCX1E390MCL1GS
		56	6.3×8	0.12	280	35	1400	450	PCX1E560MCL1GS
		82	▲8×10	0.12	410	30	1900	760	PCX1E820MCL6GS
		82	10×8	0.12	410	36	1800	800	PCX1E820MCL1GS
		120	▲8×12	0.12	600	29	2200	850	PCX1E121MCL6GS
		120	10×10	0.12	600	29	2200	790	PCX1E121MCL1GS
		180	10×12.7	0.12	900	28	2600	1010	PCX1E181MCL1GS
35 (1V)	40.2	10	6.3×6	0.12	70	85	800	310	PCX1V100MCL1GS
		18	8×7	0.12	126	60	1100	450	PCX1V180MCL1GS
		27	6.3×8	0.12	189	45	1300	450	PCX1V270MCL1GS
		39	▲8×10	0.12	273	35	1800	700	PCX1V390MCL6GS
		39	10×8	0.12	273	41	1700	750	PCX1V390MCL1GS
		56	8×12	0.12	392	33	2000	780	PCX1V560MCL1GS
		68	10×10	0.12	476	30	2200	740	PCX1V680MCL1GS
		100	10×12.7	0.12	700	29	2600	990	PCX1V101MCL1GS
50 (1H)	57.5	5.6	6.3×6	0.12	56	105	700	280	PCX1H5R6MCL1GS
		10	8×7	0.12	100	75	1000	410	PCX1H100MCL1GS
		12	6.3×8	0.12	120	65	1100	380	PCX1H120MCL1GS
		22	▲8×10	0.12	220	37	1700	680	PCX1H220MCL6GS
		22	10×8	0.12	220	56	1400	730	PCX1H220MCL1GS
		27	8×12	0.12	270	35	2000	760	PCX1H270MCL1GS
		33	10×10	0.12	330	31	2200	630	PCX1H330MCL1GS
		47	10×12.7	0.12	470	30	2500	970	PCX1H470MCL1GS

(\*3) Ambient temperature of a capacitor

No marked, [1] will be put at 12th digit of type numbering system.

▲ : In this case, [6] will be put at 12th digit of type numbering system.

• For taping specifications, recommended land size/soldering by reflow and minimum order quantity, please refer to the Guidelines for Aluminum Electrolytic Capacitors.

**PCR** Chip Type, High Reliability



- High reliability, High voltage (to 80V).
- Low ESR, High ripple current.
- Long life of 4000 hours at 125°C.
- SMD type : Lead free reflow soldering condition at 260°C peak complete correspondence.
- Compliant to the RoHS directive (2011/65/EU,(EU)2015/863).
- ESR after Endurance at -40°C.
- AEC-Q200 Qualified. Please contact us for details.

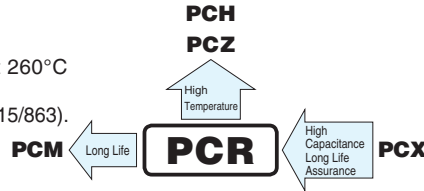

■ Specifications

Item	Performance Characteristics									
Category Temperature Range	-55 to +125°C									
Rated Voltage Range	16 to 80V									
Rated Capacitance Range	22 to 1000μF									
Capacitance Tolerance	±20% at 120Hz, 20°C									
Tangent of loss angle (tan δ)	Less than or equal to the specified value at 120Hz, 20°C									
ESR (※ 1)	Less than or equal to the specified value at 100kHz, 20°C									
Leakage Current (※ 2)	After 2 minutes' application of rated voltage, leakage current is not more than 0.03CV or 3(μA), whichever is greater. ※									
Temperature Characteristics (Max.Impedance Ratio)	Z(+125°C) / Z(+20°C) ≤ 1.25 (100kHz) Z(-55°C) / Z(+20°C) ≤ 1.25									
Endurance	The specifications listed at right shall be met when the capacitors are restored to 20°C after the rated voltage is applied for 4000 hours at 125°C.	<table border="1"> <tr><td>Capacitance change</td><td>Within ± 20% of initial capacitance value (※3)</td></tr> <tr><td>tan δ</td><td>150% or less of the initial specified value</td></tr> <tr><td>ESR (※ 1)</td><td>200% or less of the initial specified value</td></tr> <tr><td>Leakage current (※ 2)</td><td>Less than or equal to the initial specified value</td></tr> </table>	Capacitance change	Within ± 20% of initial capacitance value (※3)	tan δ	150% or less of the initial specified value	ESR (※ 1)	200% or less of the initial specified value	Leakage current (※ 2)	Less than or equal to the initial specified value
Capacitance change	Within ± 20% of initial capacitance value (※3)									
tan δ	150% or less of the initial specified value									
ESR (※ 1)	200% or less of the initial specified value									
Leakage current (※ 2)	Less than or equal to the initial specified value									
Shelf Life	After storing the capacitors under no load at 125°C for 1000 hours and then performing voltage treatment based on JIS C 5101-4 clause 4.1 at 20°C, they shall meet the specified values for the endurance characteristics listed above.									
ESR after Endurance (※ 1)	Less than or equal to the specified value at 100kHz, -40°C									
Damp Heat (Steady State)	The specifications listed at right shall be met when the capacitors are restored to 20°C after the rated voltage is applied for 1000 hours at 85°C, 85% RH.	<table border="1"> <tr><td>Capacitance change</td><td>Within ± 20% of initial capacitance value (※3)</td></tr> <tr><td>tan δ</td><td>150% or less of the initial specified value</td></tr> <tr><td>ESR (※ 1)</td><td>200% or less of the initial specified value</td></tr> <tr><td>Leakage current (※ 2)</td><td>Less than or equal to the initial specified value</td></tr> </table>	Capacitance change	Within ± 20% of initial capacitance value (※3)	tan δ	150% or less of the initial specified value	ESR (※ 1)	200% or less of the initial specified value	Leakage current (※ 2)	Less than or equal to the initial specified value
Capacitance change	Within ± 20% of initial capacitance value (※3)									
tan δ	150% or less of the initial specified value									
ESR (※ 1)	200% or less of the initial specified value									
Leakage current (※ 2)	Less than or equal to the initial specified value									
Resistance to Soldering Heat	After soldering the capacitor under the soldering conditions prescribed here, the capacitor shall meet the specifications listed at right. Pre-heating shall be done at 150 to 200°C and for 60 to 180 sec. The duration for over +230°C temperature at capacitor surface shall not exceed 60 seconds. In case peak temperature is 260°C or less, reflow soldering shall be two times maximum. Measurement for solder temperature profile shall be made at the capacitor top.	<table border="1"> <tr><td>Capacitance change</td><td>Within ± 10% of the initial capacitance value (※3)</td></tr> <tr><td>tan δ</td><td>130% or less than the initial specified value</td></tr> <tr><td>ESR (※ 1)</td><td>130% or less than the initial specified value</td></tr> <tr><td>Leakage current (※ 2)</td><td>Less than or equal to the initial specified value</td></tr> </table>	Capacitance change	Within ± 10% of the initial capacitance value (※3)	tan δ	130% or less than the initial specified value	ESR (※ 1)	130% or less than the initial specified value	Leakage current (※ 2)	Less than or equal to the initial specified value
Capacitance change	Within ± 10% of the initial capacitance value (※3)									
tan δ	130% or less than the initial specified value									
ESR (※ 1)	130% or less than the initial specified value									
Leakage current (※ 2)	Less than or equal to the initial specified value									
Marking	Navy blue print on the case top									

- ※ 1 ESR should be measured at both of the terminal ends closest where the terminals protrude through the plastic platform.
- ※ 2 Conditioning : If any doubt arises, measure the leakage current after the voltage treatment of applying DC rated voltage continuously to the capacitor for 120 minutes at 105°C.
- ※ 3 Initial value : The value before test of examination of resistance to soldering.

※ I : Leakage Current (μA), C : Rated Capacitance (μF), V : Rated Voltage (V)

Type numbering system (Example : 35V 150μF)

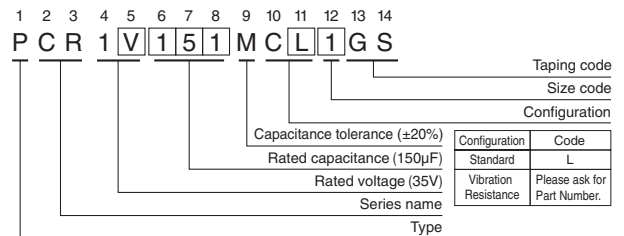

■ Dimensions

[Standard]

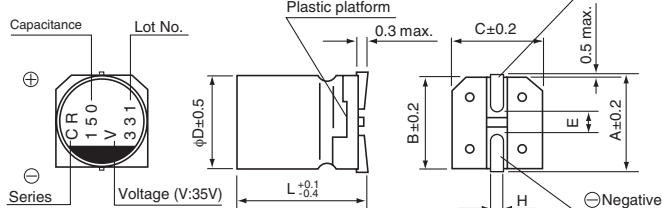

[Vibration Resistance]

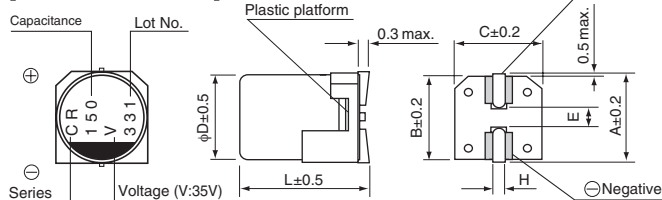

● Dimension table in next page.

■ Aid electrode

Standard (mm) Vibration Resistance (mm)

Size	φ8 × 7L	φ8 × 10L	φ8 × 12L	φ10 × 8L	φ10 × 10L	φ10 × 12.7L	Size	φ8 × 10.5L	φ10 × 10.5L	φ10 × 13.2L
φD	8.0	8.0	8.0	10.0	10.0	10.0	φD	8.0	10.0	10.0
L	6.9	9.9	11.9	7.9	9.9	12.6	L	10.0	10.0	12.7
A	9.0	9.0	9.0	11.0	11.0	11.0	A	9.0	11.0	11.0
B	8.3	8.3	8.3	10.3	10.3	10.3	B	8.3	10.3	10.3
C	8.3	8.3	8.3	10.3	10.3	10.3	C	8.3	10.3	10.3
E	3.2	3.2	3.2	4.6	4.6	4.6	E	3.1	4.6	4.6
H	0.8 to 1.1	0.8 to 1.1	0.8 to 1.1	0.8 to 1.1	0.8 to 1.1	0.8 to 1.1	H	1.1 to 1.5	1.1 to 1.5	1.1 to 1.5

Voltage

V	16	20	25	35	50	63	80
Code	C	D	E	V	H	J	K

● Frequency coefficient of rated ripple current

Frequency	120Hz	1kHz	10kHz	100kHz or more
Coefficient	0.05	0.30	0.70	1.00

※ φ8 × 10L (φ8 × 10.5L), φ10 × 10L (φ10 × 10.5L), φ10 × 12.7L (φ10 × 13.2L) : The vibration structure-resistant product is also available upon request, please ask for details. ( ) : Size of the vibration structure-resistant product.



■ Dimensions

Rated Voltage (V) (code)	Surge Voltage (V)	Rated Capacitance (μF)	Case Size φD×L (mm)	tan δ	Leakage Current (μA) (at 20°C after 2 minutes)	Initial ESR (mΩ) (20°C/100kHz)	Low temp. ESR after Endurance (mΩ) (-40°C /100kHz)	Rated Ripple (mArms) (125°C /100kHz)	Part Number
16 (1C)	20	220	8×7	0.08	105	30	60	1500	PCR1C221MCL1GS
		470	▲8×10	0.08	225	17	34	3400	PCR1C471MCL6GS
		470	10×8	0.08	225	32	64	2200	PCR1C471MCL1GS
		560	8×12	0.08	268	16	32	3800	PCR1C561MCL1GS
		680	10×10	0.08	326	19	38	3200	PCR1C681MCL1GS
		1000	10×12.7	0.08	480	13	26	4300	PCR1C102MCL1GS
20 (1D)	25	150	8×7	0.08	90	39	78	1200	PCR1D151MCL1GS
		330	▲8×10	0.08	198	19	38	3300	PCR1D331MCL6GS
		330	10×8	0.08	198	33	66	2100	PCR1D331MCL1GS
		470	8×12	0.08	282	18	36	3500	PCR1D471MCL1GS
		560	10×10	0.08	336	20	40	3100	PCR1D561MCL1GS
		680	10×12.7	0.08	408	14	28	4200	PCR1D681MCL1GS
25 (1E)	31	100	8×7	0.08	75	41	82	1200	PCR1E101MCL1GS
		220	▲8×10	0.08	165	20	40	3200	PCR1E221MCL6GS
		220	10×8	0.08	165	33	66	2100	PCR1E221MCL1GS
		270	8×12	0.08	202	19	38	3300	PCR1E271MCL1GS
		330	10×10	0.08	247	20	40	3100	PCR1E331MCL1GS
		470	10×12.7	0.08	352	15	30	4100	PCR1E471MCL1GS
35 (1V)	43	68	8×7	0.08	71	44	88	1200	PCR1V680MCL1GS
		150	▲8×10	0.08	157	22	44	3100	PCR1V151MCL6GS
		150	10×8	0.08	157	33	66	2100	PCR1V151MCL1GS
		220	8×12	0.08	231	21	42	3300	PCR1V221MCL1GS
		270	10×10	0.08	283	20	40	3100	PCR1V271MCL1GS
		330	10×12.7	0.08	346	16	32	3900	PCR1V331MCL1GS
50 (1H)	63	39	8×7	0.08	58	45	90	1300	PCR1H390MCL1GS
		82	▲8×10	0.08	123	26	52	2900	PCR1H820MCL6GS
		82	10×8	0.08	123	42	84	1900	PCR1H820MCL1GS
		120	△8×12	0.08	180	25	50	2900	PCR1H121MCL2GS
		120	10×10	0.08	180	25	50	3000	PCR1H121MCL1GS
		180	10×12.7	0.08	270	19	38	3500	PCR1H181MCL1GS
63 (1J)	79	22	8×7	0.08	41	48	96	1100	PCR1J220MCL1GS
		39	8×10	0.08	73	28	56	2700	PCR1J390MCL1GS
		47	10×8	0.08	88	47	94	1800	PCR1J470MCL1GS
		56	8×12	0.08	105	27	54	2900	PCR1J560MCL1GS
		68	10×10	0.08	128	28	56	2800	PCR1J680MCL1GS
		100	10×12.7	0.08	189	24	48	3000	PCR1J101MCL1GS
80 (1K)	100	27	8×10	0.08	64	38	76	1400	PCR1K270MCL1GS
		39	8×12	0.08	93	35	70	1600	PCR1K390MCL1GS
		47	10×10	0.08	112	33	66	1700	PCR1K470MCL1GS
		68	10×12.7	0.08	163	28	56	2100	PCR1K680MCL1GS

No marked, [1] will be put at 12th digit of type numbering system.  
 △ : In this case, [2] will be put at 12th digit of type numbering system.  
 ▲ : In this case, [6] will be put at 12th digit of type numbering system.

• For taping specifications, recommended land size/soldering by reflow and minimum order quantity, please refer to the Guidelines for Aluminum Electrolytic Capacitors.

**PCM** Chip Type, Higher Capacitance  
High Temperature Range



- High reliability, Low ESR, High ripple current.
- Long life of 8000 hours at 125°C.
- SMD type : Lead free reflow soldering condition at 260°C peak complete correspondence.
- Compliant to the RoHS directive (2011/65/EU,(EU)2015/863).
- ESR after Endurance at -40°C.
- AEC-Q200 Qualified. Please contact us for details.



■ Specifications

Item	Performance Characteristics									
Category Temperature Range	-55 to +125°C									
Rated Voltage Range	16 to 80V									
Rated Capacitance Range	12 to 1000μF									
Capacitance Tolerance	±20% at 120Hz, 20°C									
Tangent of loss angle (tan δ)	Less than or equal to the specified value at 120Hz, 20°C									
ESR (*1)	Less than or equal to the specified value at 100kHz, 20°C									
Leakage Current (*2)	After 2 minutes' application of rated voltage, leakage current is not more than 0.03CV or 3(μA), whichever is greater. ※									
Temperature Characteristics (Max.Impedance Ratio)	$Z(+125^{\circ}\text{C}) / Z(+20^{\circ}\text{C}) \leq 1.25$ (100kHz) $Z(-55^{\circ}\text{C}) / Z(+20^{\circ}\text{C}) \leq 1.25$									
Endurance	The specifications listed at right shall be met when the capacitors are restored to 20°C after the rated voltage is applied for 8000 hours (φD = 6.3:6000hours) at 125°C.	<table border="1"> <tr> <td>Capacitance change</td> <td>Within ± 20% of initial capacitance value (*3)</td> </tr> <tr> <td>tan δ</td> <td>150% or less of the initial specified value</td> </tr> <tr> <td>ESR (*1)</td> <td>200% or less of the initial specified value</td> </tr> <tr> <td>Leakage current (*2)</td> <td>Less than or equal to the initial specified value</td> </tr> </table>	Capacitance change	Within ± 20% of initial capacitance value (*3)	tan δ	150% or less of the initial specified value	ESR (*1)	200% or less of the initial specified value	Leakage current (*2)	Less than or equal to the initial specified value
Capacitance change	Within ± 20% of initial capacitance value (*3)									
tan δ	150% or less of the initial specified value									
ESR (*1)	200% or less of the initial specified value									
Leakage current (*2)	Less than or equal to the initial specified value									
Shelf Life	After storing the capacitors under no load at 125°C for 1000 hours and then performing voltage treatment based on JIS C 5101-4 clause 4.1 at 20°C, they shall meet the specified values for the endurance characteristics listed above.									
ESR after Endurance (*1)	Less than or equal to the specified value at 100kHz, -40°C									
Damp Heat (Steady State)	The specifications listed at right shall be met when the capacitors are restored to 20°C after the rated voltage is applied for 2000 hours at 85°C, 85% RH.	<table border="1"> <tr> <td>Capacitance change</td> <td>Within ± 20% of initial capacitance value (*3)</td> </tr> <tr> <td>tan δ</td> <td>150% or less of the initial specified value</td> </tr> <tr> <td>ESR (*1)</td> <td>200% or less of the initial specified value</td> </tr> <tr> <td>Leakage current (*2)</td> <td>Less than or equal to the initial specified value</td> </tr> </table>	Capacitance change	Within ± 20% of initial capacitance value (*3)	tan δ	150% or less of the initial specified value	ESR (*1)	200% or less of the initial specified value	Leakage current (*2)	Less than or equal to the initial specified value
Capacitance change	Within ± 20% of initial capacitance value (*3)									
tan δ	150% or less of the initial specified value									
ESR (*1)	200% or less of the initial specified value									
Leakage current (*2)	Less than or equal to the initial specified value									
Resistance to Soldering Heat	After soldering the capacitor under the soldering conditions prescribed here, the capacitor shall meet the specifications listed at right. Pre-heating shall be done at 150 to 200°C and for 60 to 180 sec. The duration for over +230°C temperature at capacitor surface shall not exceed 60 seconds. In case peak temperature is 260°C or less, reflow soldering shall be two times maximum. Measurement for solder temperature profile shall be made at the capacitor top.	<table border="1"> <tr> <td>Capacitance change</td> <td>Within ± 10% of the initial capacitance value (*3)</td> </tr> <tr> <td>tan δ</td> <td>130% or less than the initial specified value</td> </tr> <tr> <td>ESR (*1)</td> <td>130% or less than the initial specified value</td> </tr> <tr> <td>Leakage current (*2)</td> <td>Less than or equal to the initial specified value</td> </tr> </table>	Capacitance change	Within ± 10% of the initial capacitance value (*3)	tan δ	130% or less than the initial specified value	ESR (*1)	130% or less than the initial specified value	Leakage current (*2)	Less than or equal to the initial specified value
Capacitance change	Within ± 10% of the initial capacitance value (*3)									
tan δ	130% or less than the initial specified value									
ESR (*1)	130% or less than the initial specified value									
Leakage current (*2)	Less than or equal to the initial specified value									
Marking	Navy blue print on the case top									

- \*1 ESR should be measured at both of the terminal ends closest where the terminals protrude through the plastic platform.
- \*2 Conditioning : If any doubt arises, measure the leakage current after the voltage treatment of applying DC rated voltage continuously to the capacitor for 120 minutes at 105°C.
- \*3 Initial value : The value before test of examination of resistance to soldering.

\* I : Leakage Current (μA), C : Rated Capacitance (μF), V : Rated Voltage (V)

Type numbering system (Example : 35V 150μF)

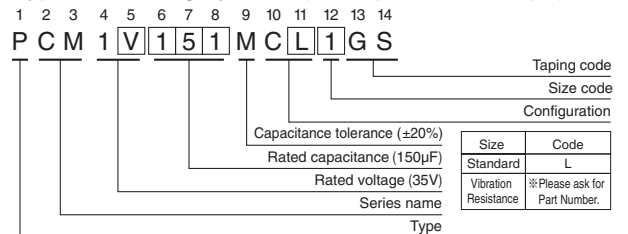

■ Dimensions [Standard]

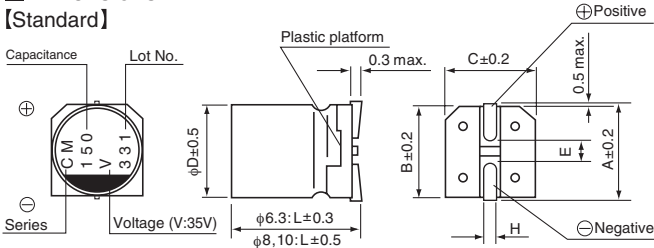

■ [Vibration Resistance]

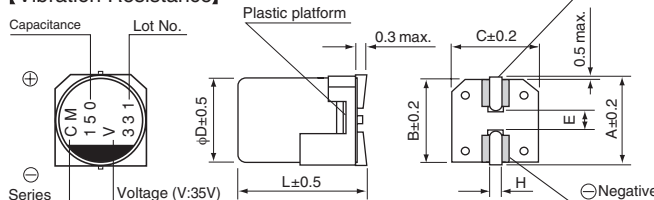

● Dimension table in next page.

■ Aid electrode

※ φ6.3x8L(φ6.3x8L), φ8x10L(φ8x10.5L), φ10x10L(φ10x10.5L), φ10x12.7L(φ10x13.2L) : The vibration structure-resistant product is also available upon request, please ask for details. ( ) : Size of the vibration structure-resistant product.

Standard	(mm)								Vibration Resistance (mm)				
	Size	φ6.3x6L	φ6.3x8L	φ8x7L	φ8x10L	φ8x12L	φ10x8L	φ10x10L	φ10x12.7L	Size	φ6.3x8L	φ8x10.5L	φ10x10.5L
φD	6.3	6.3	8.0	8.0	8.0	10.0	10.0	10.0	10.0	6.3	8.0	10.0	10.0
L	5.9	7.9	6.9	9.9	11.9	7.9	9.9	12.6	12.6	7.5	10.0	10.0	12.7
A	7.3	7.3	9.0	9.0	9.0	11.0	11.0	11.0	11.0	7.3	9.0	11.0	11.0
B	6.6	6.6	8.3	8.3	8.3	10.3	10.3	10.3	10.3	6.6	8.3	10.3	10.3
C	6.6	6.6	8.3	8.3	8.3	10.3	10.3	10.3	10.3	6.6	8.3	10.3	10.3
E	2.1	2.1	3.2	3.2	3.2	4.6	4.6	4.6	4.6	2.5	3.1	4.6	4.6
H	0.5 to 0.8	0.5 to 0.8	0.8 to 1.1	0.8 to 1.1	0.8 to 1.1	0.8 to 1.1	0.8 to 1.1	0.8 to 1.1	0.8 to 1.1	0.5 to 0.8	1.1 to 1.5	1.1 to 1.5	1.1 to 1.5

Voltage		● Frequency coefficient of rated ripple current										
V	16	20	25	35	50	63	80	Frequency	120Hz	1kHz	10kHz	100kHz or more
Code	C	D	E	V	H	J	K	Coefficient	0.05	0.30	0.70	1.00



■ Dimensions

Rated Voltage (V) (code)	Surge Voltage (V)	Rated Capacitance (μF)	Case Size φD×L (mm)	tan δ	Leakage Current (μA) (at 20°C after 2 minutes)	Initial ESR (mΩ) (20°C/100kHz)	Low temp. ESR after Endurance (mΩ) (-40°C /100kHz)	Rated Ripple (mArms) (125°C /100kHz)	Part Number
16 (1C)	20	120	6.3×6	0.08	57	36	72	1200	PCM1C121MCL1GS
		220	■ 6.3×8	0.08	105	23	46	1700	PCM1C221MCL4GS
		220	8×7	0.08	105	30	60	1500	PCM1C221MCL1GS
		470	▲ 8×10	0.08	225	17	34	2400	PCM1C471MCL6GS
		470	10×8	0.08	225	22	44	1900	PCM1C471MCL1GS
		560	8×12	0.08	268	16	32	2700	PCM1C561MCL1GS
		680	10×10	0.08	326	19	38	2300	PCM1C681MCL1GS
		1000	10×12.7	0.08	480	13	26	2800	PCM1C102MCL1GS
20 (1D)	25	100	6.3×6	0.08	60	41	82	1200	PCM1D101MCL1GS
		150	■ 6.3×8	0.08	90	25	50	1700	PCM1D151MCL4GS
		150	8×7	0.08	90	39	78	1700	PCM1D151MCL1GS
		330	▲ 8×10	0.08	198	19	38	2400	PCM1D331MCL6GS
		330	10×8	0.08	198	23	46	2000	PCM1D331MCL1GS
		470	8×12	0.08	282	18	36	2800	PCM1D471MCL1GS
		560	10×10	0.08	336	20	40	2500	PCM1D561MCL1GS
		680	10×12.7	0.08	408	14	28	3500	PCM1D681MCL1GS
25 (1E)	31	56	6.3×6	0.08	42	43	86	1200	PCM1E560MCL1GS
		100	■ 6.3×8	0.08	75	27	54	1700	PCM1E101MCL4GS
		100	8×7	0.08	75	41	82	1700	PCM1E101MCL1GS
		220	▲ 8×10	0.08	165	20	40	2400	PCM1E221MCL6GS
		220	10×8	0.08	165	24	48	2000	PCM1E221MCL1GS
		270	8×12	0.08	202	19	38	2800	PCM1E271MCL1GS
		330	10×10	0.08	247	20	40	2500	PCM1E331MCL1GS
		470	10×12.7	0.08	352	15	30	3500	PCM1E471MCL1GS
35 (1V)	43	47	6.3×6	0.08	49	48	96	1200	PCM1V470MCL1GS
		68	■ 6.3×8	0.08	71	31	62	1700	PCM1V680MCL4GS
		68	8×7	0.08	71	44	88	1700	PCM1V680MCL1GS
		150	▲ 8×10	0.08	157	22	44	2400	PCM1V151MCL6GS
		150	10×8	0.08	157	25	50	2000	PCM1V151MCL1GS
		220	8×12	0.08	231	21	42	2800	PCM1V221MCL1GS
		270	10×10	0.08	283	20	40	2500	PCM1V271MCL1GS
		330	10×12.7	0.08	346	16	32	3500	PCM1V331MCL1GS
50 (1H)	63	22	6.3×6	0.08	33	50	100	1000	PCM1H220MCL1GS
		39	■ 6.3×8	0.08	58	36	72	1200	PCM1H390MCL4GS
		39	8×7	0.08	58	45	90	1600	PCM1H390MCL1GS
		82	▲ 8×10	0.08	123	26	52	2100	PCM1H820MCL6GS
		82	10×8	0.08	123	34	68	2000	PCM1H820MCL1GS
		120	△ 8×12	0.08	180	25	50	2500	PCM1H121MCL2GS
		120	10×10	0.08	180	25	50	2500	PCM1H121MCL1GS
		180	10×12.7	0.08	270	19	38	3200	PCM1H181MCL1GS
63 (1J)	79	12	6.3×6	0.08	22	51	102	1000	PCM1J120MCL1GS
		22	■ 6.3×8	0.08	41	45	90	1200	PCM1J220MCL4GS
		22	8×7	0.08	41	48	96	1600	PCM1J220MCL1GS
		39	8×10	0.08	73	28	56	2100	PCM1J390MCL1GS
		47	10×8	0.08	88	35	70	2000	PCM1J470MCL1GS
		56	8×12	0.08	105	27	54	2500	PCM1J560MCL1GS
		68	10×10	0.08	128	28	56	2500	PCM1J680MCL1GS
		100	10×12.7	0.08	189	24	48	3200	PCM1J101MCL1GS
80 (1K)	100	12	6.3×8	0.08	28	50	100	1000	PCM1K120MCL1GS
		27	8×10	0.08	64	38	76	1400	PCM1K270MCL1GS
		39	8×12	0.08	93	35	70	1800	PCM1K390MCL1GS
		47	10×10	0.08	112	33	66	1800	PCM1K470MCL1GS
		68	10×12.7	0.08	163	28	56	2200	PCM1K680MCL1GS

• For taping specifications, recommended land size/soldering by reflow and minimum order quantity, please refer to the Guidelines for Aluminum Electrolytic Capacitors.

No marked, [1] will be put at 12th digit of type numbering system.  
 △ : In this case, [2] will be put at 12th digit of type numbering system.  
 ■ : In this case, [4] will be put at 12th digit of type numbering system.  
 ▲ : In this case, [6] will be put at 12th digit of type numbering system.



**PCH** Chip Type, Higher Capacitance  
High Temperature Range



- High reliability, High voltage (to 80V).
- Low ESR, High ripple current.
- Long life of 4000 hours at 135°C.
- SMD type : Lead free reflow soldering condition at 260°C peak complete correspondence.
- Compliant to the RoHS directive (2011/65/EU, (EU)2015/863).
- ESR after Endurance at -40°C.
- AEC-Q200 Qualified. Please contact us for details.

**Specifications**

Item	Performance Characteristics									
Category Temperature Range	-55 to +135°C									
Rated Voltage Range	16 to 80V									
Rated Capacitance Range	12 to 1000µF									
Capacitance Tolerance	±20% at 120Hz, 20°C									
Tangent of loss angle (tan δ)	Less than or equal to the specified value at 120Hz, 20°C									
ESR (※ 1)	Less than or equal to the specified value at 100kHz, 20°C									
Leakage Current (※ 2)	After 2 minutes' application of rated voltage, leakage current is not more than 0.03CV or 3(µA), whichever is greater. ※									
Temperature Characteristics (Max.Impedance Ratio)	$Z(-55^{\circ}\text{C}) / Z(+20^{\circ}\text{C}) \leq 1.25$ (100kHz)									
Endurance	The specifications listed at right shall be met when the capacitors are restored to 20°C after the rated voltage is applied for 4000 hours at 135°C.	<table border="1"> <tr><td>Capacitance change</td><td>Within ± 20% of initial capacitance value (※3)</td></tr> <tr><td>tan δ</td><td>150% or less of the initial specified value</td></tr> <tr><td>ESR (※ 1)</td><td>200% or less of the initial specified value</td></tr> <tr><td>Leakage current (※ 2)</td><td>Less than or equal to the initial specified value</td></tr> </table>	Capacitance change	Within ± 20% of initial capacitance value (※3)	tan δ	150% or less of the initial specified value	ESR (※ 1)	200% or less of the initial specified value	Leakage current (※ 2)	Less than or equal to the initial specified value
Capacitance change	Within ± 20% of initial capacitance value (※3)									
tan δ	150% or less of the initial specified value									
ESR (※ 1)	200% or less of the initial specified value									
Leakage current (※ 2)	Less than or equal to the initial specified value									
Shelf Life	After storing the capacitors under no load at 135°C for 1000 hours and then performing voltage treatment based on JIS C 5101-4 clause 4.1 at 20°C, they shall meet the specified values for the endurance characteristics listed above.									
ESR after Endurance (※ 1)	Less than or equal to the specified value at 100kHz, -40°C									
Damp Heat (Steady State)	The specifications listed at right shall be met when the capacitors are restored to 20°C after the rated voltage is applied for 2000 hours at 85°C, 85% RH.	<table border="1"> <tr><td>Capacitance change</td><td>Within ± 20% of initial capacitance value (※3)</td></tr> <tr><td>tan δ</td><td>150% or less of the initial specified value</td></tr> <tr><td>ESR (※ 1)</td><td>200% or less of the initial specified value</td></tr> <tr><td>Leakage current (※ 2)</td><td>Less than or equal to the initial specified value</td></tr> </table>	Capacitance change	Within ± 20% of initial capacitance value (※3)	tan δ	150% or less of the initial specified value	ESR (※ 1)	200% or less of the initial specified value	Leakage current (※ 2)	Less than or equal to the initial specified value
Capacitance change	Within ± 20% of initial capacitance value (※3)									
tan δ	150% or less of the initial specified value									
ESR (※ 1)	200% or less of the initial specified value									
Leakage current (※ 2)	Less than or equal to the initial specified value									
Resistance to Soldering Heat	After soldering the capacitor under the soldering conditions prescribed here, the capacitor shall meet the specifications listed at right. Pre-heating shall be done at 150 to 200°C and for 60 to 180 sec. The duration for over +230°C temperature at capacitor surface shall not exceed 60 seconds. In case peak temperature is 260°C or less, reflow soldering shall be two times maximum. Measurement for solder temperature profile shall be made at the capacitor top.	<table border="1"> <tr><td>Capacitance change</td><td>Within ± 10% of the initial capacitance value (※3)</td></tr> <tr><td>tan δ</td><td>130% or less than the initial specified value</td></tr> <tr><td>ESR (※ 1)</td><td>130% or less than the initial specified value</td></tr> <tr><td>Leakage current (※ 2)</td><td>Less than or equal to the initial specified value</td></tr> </table>	Capacitance change	Within ± 10% of the initial capacitance value (※3)	tan δ	130% or less than the initial specified value	ESR (※ 1)	130% or less than the initial specified value	Leakage current (※ 2)	Less than or equal to the initial specified value
Capacitance change	Within ± 10% of the initial capacitance value (※3)									
tan δ	130% or less than the initial specified value									
ESR (※ 1)	130% or less than the initial specified value									
Leakage current (※ 2)	Less than or equal to the initial specified value									
Marking	Navy blue print on the case top									

- ※ 1 ESR should be measured at both of the terminal ends closest where the terminals protrude through the plastic platform.
- ※ 2 Conditioning : If any doubt arises, measure the leakage current after the voltage treatment of applying DC rated voltage continuously to the capacitor for 120 minutes at 105°C.
- ※ 3 Initial value : The value before test of examination of resistance to soldering.

※ I : Leakage Current (µA), C : Rated Capacitance (µF), V : Rated Voltage (V)

**Type numbering system (Example : 35V 150µF)**

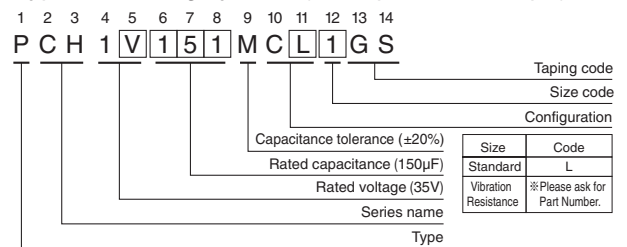

※ φ6.3x8L(φ6.3x8L), φ8x10L(φ8x10.5L), φ10x10L(φ10x10.5L), φ10x12.7L(φ10x13.2L) : The vibration structure-resistant product is also available upon request, please ask for details.  
( ) : Size of the vibration structure-resistant product.

**Dimensions**

**[Standard]**

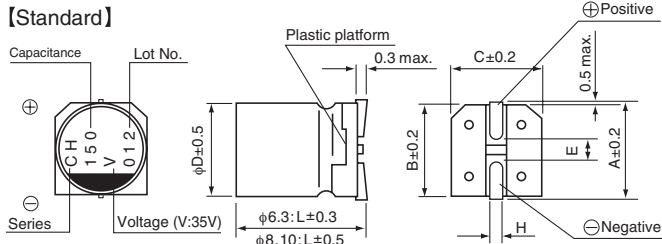

**[Vibration Resistance]**

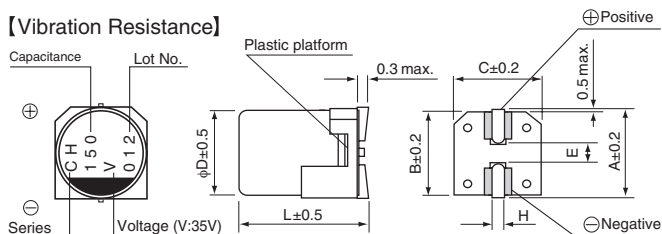

■ Aid electrode

● Dimension table in next page.

Standard		(mm)							Vibration Resistance					
Size		φ6.3x6L	φ6.3x8L	φ8x7L	φ8x10L	φ8x12L	φ10x8L	φ10x10L	φ10x12.7L	Size	φ6.3x8L	φ8x10.5L	φ10x10.5L	φ10x13.2L
φD	6.3	6.3	8.0	8.0	8.0	8.0	10.0	10.0	10.0	φD	6.3	8.0	10.0	10.0
L	5.9	7.9	6.9	9.9	11.9	7.9	9.9	12.6		L	7.5	10.0	10.0	12.7
A	7.3	7.3	9.0	9.0	9.0	11.0	11.0	11.0		A	7.3	9.0	11.0	11.0
B	6.6	6.6	8.3	8.3	8.3	10.3	10.3	10.3		B	6.6	8.3	10.3	10.3
C	6.6	6.6	8.3	8.3	8.3	10.3	10.3	10.3		C	6.6	8.3	10.3	10.3
E	2.1	2.1	3.2	3.2	3.2	4.6	4.6	4.6		E	2.5	3.1	4.6	4.6
H	0.5 to 0.8	0.5 to 0.8	0.8 to 1.1	0.8 to 1.1	0.8 to 1.1	0.8 to 1.1	0.8 to 1.1	0.8 to 1.1		H	0.5 to 0.8	1.1 to 1.5	1.1 to 1.5	1.1 to 1.5

Voltage		Frequency coefficient of rated ripple current				
V		Frequency	120Hz	1kHz	10kHz	100kHz or more
V	16 20 25 35 50 63 80	Coefficient	0.05	0.30	0.70	1.00
Code	C D E V H J K					



■ Dimensions

Rated Voltage (V) (code)	Surge Voltage (V)	Rated Capacitance (μF)	Case Size φD×L (mm)	tan δ	Leakage Current (μA) (at 20°C after 2 minutes)	Initial ESR (mΩ) (20°C/100kHz)	Low temp. ESR after Endurance (mΩ) (-40°C /100kHz)	Rated Ripple (mArms) (135°C /100kHz)	Part Number
16 (1C)	20	120	6.3×6	0.08	57	36	72	900	PCH1C121MCL1GS
		220	■ 6.3×8	0.08	105	23	46	1500	PCH1C221MCL4GS
		220	8×7	0.08	105	30	60	1100	PCH1C221MCL1GS
		470	▲ 8×10	0.08	225	17	34	2400	PCH1C471MCL6GS
		470	10×8	0.08	225	22	44	1900	PCH1C471MCL1GS
		560	8×12	0.08	268	16	32	2700	PCH1C561MCL1GS
		680	10×10	0.08	326	19	38	2300	PCH1C681MCL1GS
		1000	10×12.7	0.08	480	13	26	2500	PCH1C102MCL1GS
20 (1D)	25	100	6.3×6	0.08	60	41	82	900	PCH1D101MCL1GS
		150	■ 6.3×8	0.08	90	25	50	1200	PCH1D151MCL4GS
		150	8×7	0.08	90	39	78	800	PCH1D151MCL1GS
		330	▲ 8×10	0.08	198	19	38	2300	PCH1D331MCL6GS
		330	10×8	0.08	198	23	46	1800	PCH1D331MCL1GS
		470	8×12	0.08	282	18	36	2500	PCH1D471MCL1GS
		560	10×10	0.08	336	20	40	2200	PCH1D561MCL1GS
		680	10×12.7	0.08	408	14	28	3000	PCH1D681MCL1GS
25 (1E)	31	56	6.3×6	0.08	42	43	86	900	PCH1E560MCL1GS
		100	■ 6.3×8	0.08	75	27	54	1100	PCH1E101MCL4GS
		100	8×7	0.08	75	41	82	800	PCH1E101MCL1GS
		220	▲ 8×10	0.08	165	20	40	2300	PCH1E221MCL6GS
		220	10×8	0.08	165	24	48	1800	PCH1E221MCL1GS
		270	8×12	0.08	202	19	38	2300	PCH1E271MCL1GS
		330	10×10	0.08	247	20	40	2200	PCH1E331MCL1GS
		470	10×12.7	0.08	352	15	30	2900	PCH1E471MCL1GS
35 (1V)	43	47	6.3×6	0.08	49	48	96	800	PCH1V470MCL1GS
		68	■ 6.3×8	0.08	71	31	62	1100	PCH1V680MCL4GS
		68	8×7	0.08	71	44	88	800	PCH1V680MCL1GS
		150	▲ 8×10	0.08	157	22	44	2200	PCH1V151MCL6GS
		150	10×8	0.08	157	25	50	1800	PCH1V151MCL1GS
		220	8×12	0.08	231	21	42	2300	PCH1V221MCL1GS
		270	10×10	0.08	283	20	40	2200	PCH1V271MCL1GS
		330	10×12.7	0.08	346	16	32	2800	PCH1V331MCL1GS
50 (1H)	63	22	6.3×6	0.08	33	50	100	700	PCH1H220MCL1GS
		39	■ 6.3×8	0.08	58	36	72	900	PCH1H390MCL4GS
		39	8×7	0.08	58	45	90	900	PCH1H390MCL1GS
		82	▲ 8×10	0.08	123	26	52	2100	PCH1H820MCL6GS
		82	10×8	0.08	123	34	68	1600	PCH1H820MCL1GS
		120	△ 8×12	0.08	180	25	50	2100	PCH1H121MCL2GS
		120	10×10	0.08	180	25	50	2100	PCH1H121MCL1GS
		180	10×12.7	0.08	270	19	38	2500	PCH1H181MCL1GS
63 (1J)	79	12	6.3×6	0.08	22	51	102	700	PCH1J120MCL1GS
		22	■ 6.3×8	0.08	41	45	90	800	PCH1J220MCL4GS
		22	8×7	0.08	41	48	96	800	PCH1J220MCL1GS
		39	8×10	0.08	73	28	56	1900	PCH1J390MCL1GS
		47	10×8	0.08	88	35	70	1500	PCH1J470MCL1GS
		56	8×12	0.08	105	27	54	2100	PCH1J560MCL1GS
		68	10×10	0.08	128	28	56	2000	PCH1J680MCL1GS
		100	10×12.7	0.08	189	24	48	2100	PCH1J101MCL1GS
80 (1K)	100	12	6.3×8	0.08	28	50	100	800	PCH1K120MCL1GS
		27	8×10	0.08	64	38	76	1000	PCH1K270MCL1GS
		39	8×12	0.08	93	35	70	1100	PCH1K390MCL1GS
		47	10×10	0.08	112	33	66	1200	PCH1K470MCL1GS
		68	10×12.7	0.08	163	28	56	1500	PCH1K680MCL1GS

• For taping specifications, recommended land size/soldering by reflow and minimum order quantity, please refer to the Guidelines for Aluminum Electrolytic Capacitors.

No marked, [1] will be put at 12th digit of type numbering system.  
 △: In this case, [2] will be put at 12th digit of type numbering system.  
 ■: In this case, [4] will be put at 12th digit of type numbering system.  
 ▲: In this case, [6] will be put at 12th digit of type numbering system.

**PCZ** Chip Type, Higher Capacitance  
High Temperature Range



- High reliability.
- Low ESR, High ripple current.
- Long life of 2000 hours at 150°C.
- SMD type : Lead free reflow soldering condition at 260°C peak complete correspondence.
- Compliant to the RoHS directive (2011/65/EU,(EU)2015/863).
- ESR after Endurance at -40°C.
- AEC-Q200 Qualified. Please contact us for details.



■ Specifications

Item	Performance Characteristics								
Category Temperature Range	-55 to +150°C								
Rated Voltage Range	16 to 63V								
Rated Capacitance Range	12 to 1000μF								
Capacitance Tolerance	±20% at 120Hz, 20°C								
Tangent of loss angle (tan δ)	Less than or equal to the specified value at 120Hz, 20°C								
ESR (※ 1)	Less than or equal to the specified value at 100kHz, 20°C								
Leakage Current (※ 2)	After 2 minutes' application of rated voltage, leakage current is not more than 0.03CV or 3(μA), whichever is greater. ※								
Temperature Characteristics (Max.Impedance Ratio)	$Z(-55^{\circ}\text{C}) / Z(+20^{\circ}\text{C}) \leq 1.25$ (100kHz)								
Endurance	<p>The specifications listed at right shall be met when the capacitors are restored to 20°C after the rated voltage is applied for 2000 hours at 150°C.</p> <table border="1"> <tr><td>Capacitance change</td><td>Within ± 20% of initial capacitance value (※3)</td></tr> <tr><td>tan δ</td><td>150% or less of the initial specified value</td></tr> <tr><td>ESR (※ 1)</td><td>200% or less of the initial specified value</td></tr> <tr><td>Leakage current (※ 2)</td><td>Less than or equal to the initial specified value</td></tr> </table>	Capacitance change	Within ± 20% of initial capacitance value (※3)	tan δ	150% or less of the initial specified value	ESR (※ 1)	200% or less of the initial specified value	Leakage current (※ 2)	Less than or equal to the initial specified value
Capacitance change	Within ± 20% of initial capacitance value (※3)								
tan δ	150% or less of the initial specified value								
ESR (※ 1)	200% or less of the initial specified value								
Leakage current (※ 2)	Less than or equal to the initial specified value								
ESR after Endurance (※ 1)	Less than or equal to the specified value at 100kHz, -40°C								
Damp Heat (Steady State)	<p>The specifications listed at right shall be met when the capacitors are restored to 20°C after the rated voltage is applied for 2000 hours at 85°C , 85% RH.</p> <table border="1"> <tr><td>Capacitance change</td><td>Within ± 20% of initial capacitance value (※3)</td></tr> <tr><td>tan δ</td><td>150% or less of the initial specified value</td></tr> <tr><td>ESR (※ 1)</td><td>200% or less of the initial specified value</td></tr> <tr><td>Leakage current (※ 2)</td><td>Less than or equal to the initial specified value</td></tr> </table>	Capacitance change	Within ± 20% of initial capacitance value (※3)	tan δ	150% or less of the initial specified value	ESR (※ 1)	200% or less of the initial specified value	Leakage current (※ 2)	Less than or equal to the initial specified value
Capacitance change	Within ± 20% of initial capacitance value (※3)								
tan δ	150% or less of the initial specified value								
ESR (※ 1)	200% or less of the initial specified value								
Leakage current (※ 2)	Less than or equal to the initial specified value								
Resistance to Soldering Heat	<p>After soldering the capacitor under the soldering conditions prescribed here, the capacitor shall meet the specifications listed at right.</p> <p>Pre-heating shall be done at 150 to 200°C and for 60 to 180 sec. The duration for over +230°C temperature at capacitor surface shall not exceed 60 seconds.</p> <p>In case peak temperature is 260°C or less, reflow soldering shall be two times maximum.</p> <p>Measurement for solder temperature profile shall be made at the capacitor top.</p> <table border="1"> <tr><td>Capacitance change</td><td>Within ± 10% of the initial capacitance value (※3)</td></tr> <tr><td>tan δ</td><td>130% or less than the initial specified value</td></tr> <tr><td>ESR (※ 1)</td><td>130% or less than the initial specified value</td></tr> <tr><td>Leakage current (※ 2)</td><td>Less than or equal to the initial specified value</td></tr> </table>	Capacitance change	Within ± 10% of the initial capacitance value (※3)	tan δ	130% or less than the initial specified value	ESR (※ 1)	130% or less than the initial specified value	Leakage current (※ 2)	Less than or equal to the initial specified value
Capacitance change	Within ± 10% of the initial capacitance value (※3)								
tan δ	130% or less than the initial specified value								
ESR (※ 1)	130% or less than the initial specified value								
Leakage current (※ 2)	Less than or equal to the initial specified value								
Marking	Navy blue print on the case top								

- ※ 1 ESR should be measured at both of the terminal ends closest where the terminals protrude through the plastic platform.
- ※ 2 Conditioning : If any doubt arises, measure the leakage current after the voltage treatment of applying DC rated voltage continuously to the capacitor for 120 minutes at 105°C.
- ※ 3 Initial value : The value before test of examination of resistance to soldering.

※ I : Leakage Current (μA), C : Rated Capacitance (μF), V : Rated Voltage (V)

■ Dimensions  
[Standard]

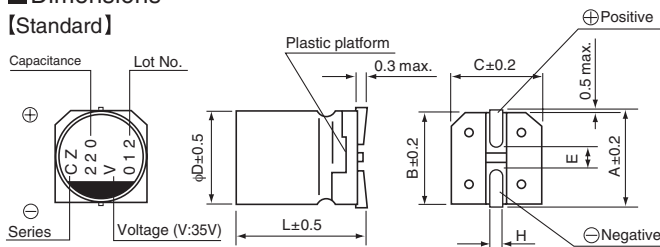

[Vibration Resistance]

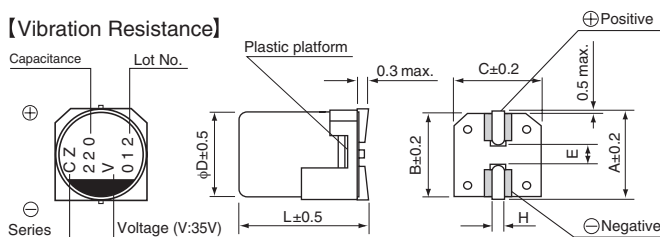

● Dimension table in next page.

Type numbering system (Example : 35V 220μF)

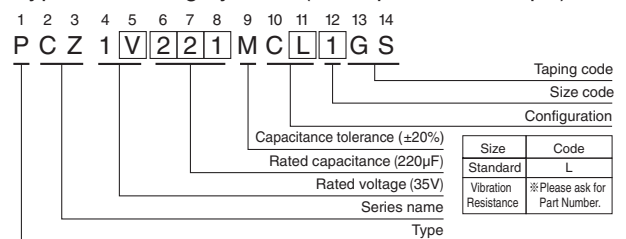

※ φ8×10L(φ8×10.5L), φ10×10L(φ10×10.5L), φ10×12.7L(φ10×13.2L) :  
The vibration structure-resistant product is also available upon request, please ask for details.  
( ) : Size of the vibration structure-resistant product.

Standard (mm)							Vibration Resistance (mm)			
Size	φ8×7L	φ8×10L	φ8×12L	φ10×8L	φ10×10L	φ10×12.7L	Size	φ8×10.5L	φ10×10.5L	φ10×13.2L
φD	8.0	8.0	8.0	10.0	10.0	10.0	φD	8.0	10.0	10.0
L	6.9	9.9	11.9	7.9	9.9	12.6	L	10.0	10.0	12.7
A	9.0	9.0	9.0	11.0	11.0	11.0	A	9.0	11.0	11.0
B	8.3	8.3	8.3	10.3	10.3	10.3	B	8.3	10.3	10.3
C	8.3	8.3	8.3	10.3	10.3	10.3	C	8.3	10.3	10.3
E	3.2	3.2	3.2	4.6	4.6	4.6	E	3.1	4.6	4.6
H	0.8 to 1.1	0.8 to 1.1	0.8 to 1.1	0.8 to 1.1	0.8 to 1.1	0.8 to 1.1	H	1.1 to 1.5	1.1 to 1.5	1.1 to 1.5

Voltage						Frequency coefficient of rated ripple current					
V	16	20	25	35	50	63	Frequency	120Hz	1kHz	10kHz	100kHz or more
Code	C	D	E	V	H	J	Coefficient	0.05	0.30	0.70	1.00



■ Dimensions

Rated Voltage (V) (code)	Surge Voltage (V)	Rated Capacitance (μF)	Case Size φD×L (mm)	tan δ	Leakage Current (μA) (at 20°C after 2 minutes)	Initial ESR (mΩ) (20°C/100kHz)	Low temp. ESR after Endurance (mΩ) (-40°C /100kHz)	Rated Ripple (mArms) (150°C /100kHz)	Part Number
16 (1C)	20	220	8×7	0.08	105	30	60	800	PCZ1C221MCL1GS
		470	▲8×10	0.08	225	17	34	1900	PCZ1C471MCL6GS
		470	10×8	0.08	225	32	64	1400	PCZ1C471MCL1GS
		560	△8×12	0.08	268	16	32	2000	PCZ1C561MCL2GS
		680	10×10	0.08	326	19	38	1900	PCZ1C681MCL1GS
		1000	10×12.7	0.08	480	13	26	2200	PCZ1C102MCL1GS
20 (1D)	25	100	8×7	0.08	60	39	78	600	PCZ1D101MCL1GS
		220	▲8×10	0.08	132	20	40	1800	PCZ1D221MCL6GS
		220	10×8	0.08	132	33	66	1400	PCZ1D221MCL1GS
		270	△8×12	0.08	162	18	36	1900	PCZ1D271MCL2GS
		330	10×10	0.08	198	20	40	1800	PCZ1D331MCL1GS
		470	10×12.7	0.08	282	15	30	2100	PCZ1D471MCL1GS
25 (1E)	31	68	8×7	0.08	51	41	82	600	PCZ1E680MCL1GS
		150	▲8×10	0.08	112	20	40	1800	PCZ1E151MCL6GS
		150	10×8	0.08	112	33	66	1400	PCZ1E151MCL1GS
		180	△8×12	0.08	135	19	38	1900	PCZ1E181MCL2GS
		270	10×10	0.08	202	20	40	1800	PCZ1E271MCL1GS
		330	10×12.7	0.08	247	15	30	2100	PCZ1E331MCL1GS
35 (1V)	43	47	8×7	0.08	49	44	88	600	PCZ1V470MCL1GS
		100	▲8×10	0.08	105	22	44	1700	PCZ1V101MCL6GS
		100	10×8	0.08	105	33	66	1400	PCZ1V101MCL1GS
		150	△8×12	0.08	157	21	42	1800	PCZ1V151MCL2GS
		180	10×10	0.08	189	20	40	1800	PCZ1V181MCL1GS
		220	10×12.7	0.08	231	16	32	2000	PCZ1V221MCL1GS
50 (1H)	63	22	8×7	0.08	33	48	96	600	PCZ1H220MCL1GS
		47	▲8×10	0.08	70	28	56	1500	PCZ1H470MCL6GS
		47	10×8	0.08	70	35	70	1300	PCZ1H470MCL1GS
		56	△8×12	0.08	84	27	54	1500	PCZ1H560MCL2GS
		68	10×10	0.08	102	28	56	1500	PCZ1H680MCL1GS
		100	10×12.7	0.08	150	24	48	1600	PCZ1H101MCL1GS
63 (1J)	79	12	8×7	0.08	22	52	104	400	PCZ1J120MCL1GS
		27	▲8×10	0.08	51	38	76	1300	PCZ1J270MCL6GS
		27	10×8	0.08	51	37	74	1300	PCZ1J270MCL1GS
		39	△8×12	0.08	73	35	70	1300	PCZ1J390MCL2GS
		47	10×10	0.08	88	33	66	1400	PCZ1J470MCL1GS
		68	10×12.7	0.08	128	28	56	1500	PCZ1J680MCL1GS

No marked, [1] will be put at 12th digit of type numbering system.  
 △: In this case, [2] will be put at 12th digit of type numbering system.  
 ▲: In this case, [6] will be put at 12th digit of type numbering system.

• For taping specifications, recommended land size/soldering by reflow and minimum order quantity, please refer to the Guidelines for Aluminum Electrolytic Capacitors.

**PLF**

Radial Lead Type, Standard



- Low ESR, High ripple current.
- Load life of 2000 hours at 105°C.
- Radial lead type :  
Lead free flow soldering condition correspondence.
- Compliant to the RoHS directive (2011/65/EU,(EU)2015/863).
- AEC-Q200 Qualified. Please contact us for details.

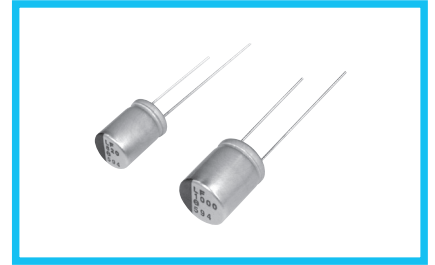
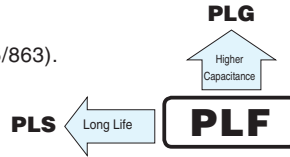

■ Specifications

Item	Performance Characteristics									
Category Temperature Range	-55 to +105°C									
Rated Voltage Range	2.5 to 25V									
Rated Capacitance Range	6.8 to 1500μF									
Capacitance Tolerance	±20% at 120Hz, 20°C									
Tangent of loss angle (tan δ)	Less than or equal to the specified value at 120Hz, 20°C									
ESR (※ 1)	Less than or equal to the specified value at 100kHz, 20°C									
Leakage Current (※ 2)	Less than or equal to the specified value. After 2 minutes' application of rated voltage at 20°C									
Temperature Characteristics (Max.Impedance Ratio)	$Z(+105^{\circ}\text{C}) / Z(+20^{\circ}\text{C}) \leq 1.25$ (100kHz) $Z(-55^{\circ}\text{C}) / Z(+20^{\circ}\text{C}) \leq 1.25$									
Endurance	The specifications listed at right shall be met when the capacitors are restored to 20°C after the rated voltage is applied for 2000 hours at 105°C.	<table border="1"> <tr><td>Capacitance change</td><td>Within ± 20% of the initial capacitance value (※ 3)</td></tr> <tr><td>tan δ</td><td>150% or less than the initial specified value</td></tr> <tr><td>ESR (※ 1)</td><td>150% or less than the initial specified value</td></tr> <tr><td>Leakage current (※ 2)</td><td>Less than or equal to the initial specified value</td></tr> </table>	Capacitance change	Within ± 20% of the initial capacitance value (※ 3)	tan δ	150% or less than the initial specified value	ESR (※ 1)	150% or less than the initial specified value	Leakage current (※ 2)	Less than or equal to the initial specified value
Capacitance change	Within ± 20% of the initial capacitance value (※ 3)									
tan δ	150% or less than the initial specified value									
ESR (※ 1)	150% or less than the initial specified value									
Leakage current (※ 2)	Less than or equal to the initial specified value									
Damp Heat (Steady State)	The specifications listed at right shall be met when the capacitors are restored to 20°C after the rated voltage is applied for 1000 hours at 60°C, 90% RH.	<table border="1"> <tr><td>Capacitance change</td><td>Within ± 20% of the initial capacitance value (※ 3)</td></tr> <tr><td>tan δ</td><td>150% or less than the initial specified value</td></tr> <tr><td>ESR (※ 1)</td><td>150% or less than the initial specified value</td></tr> <tr><td>Leakage current (※ 2)</td><td>Less than or equal to the initial specified value</td></tr> </table>	Capacitance change	Within ± 20% of the initial capacitance value (※ 3)	tan δ	150% or less than the initial specified value	ESR (※ 1)	150% or less than the initial specified value	Leakage current (※ 2)	Less than or equal to the initial specified value
Capacitance change	Within ± 20% of the initial capacitance value (※ 3)									
tan δ	150% or less than the initial specified value									
ESR (※ 1)	150% or less than the initial specified value									
Leakage current (※ 2)	Less than or equal to the initial specified value									
Resistance to Soldering Heat	After soldering the capacitor under the soldering conditions prescribed here as preheat at 150 to 200°C for 60 to 180 seconds and peak temperature at 265°C for 10 seconds or less, the capacitor shall meet the specifications listed at right, provided that its temperature profile is measured at both of terminal ends facing the soldering side.	<table border="1"> <tr><td>Capacitance change</td><td>Within ± 10% of the initial capacitance value (※ 3)</td></tr> <tr><td>tan δ</td><td>130% or less than the initial specified value</td></tr> <tr><td>ESR (※ 1)</td><td>130% or less than the initial specified value</td></tr> <tr><td>Leakage current (※ 2)</td><td>Less than or equal to the initial specified value</td></tr> </table>	Capacitance change	Within ± 10% of the initial capacitance value (※ 3)	tan δ	130% or less than the initial specified value	ESR (※ 1)	130% or less than the initial specified value	Leakage current (※ 2)	Less than or equal to the initial specified value
Capacitance change	Within ± 10% of the initial capacitance value (※ 3)									
tan δ	130% or less than the initial specified value									
ESR (※ 1)	130% or less than the initial specified value									
Leakage current (※ 2)	Less than or equal to the initial specified value									
Marking	Navy blue print on the case top									

- ※ 1 ESR should be measured at both of the terminal ends closest to the capacitor body.
- ※ 2 Conditioning : If any doubt arises, measure the leakage current after the voltage treatment of applying DC rated voltage continuously to the capacitor for 120 minutes at 105°C.
- ※ 3 Initial value : The value before test of examination of resistance to soldering.

■ Dimensions

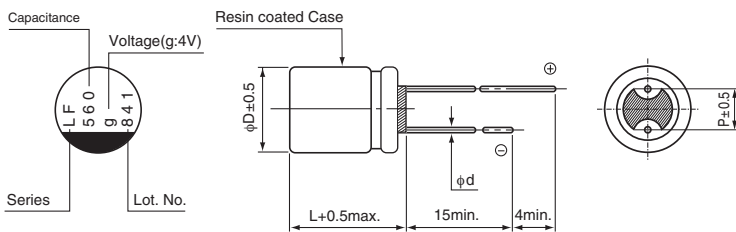

Type numbering system (Example : 4V 560μF)

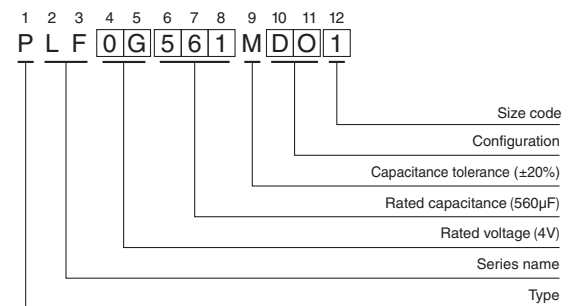

Size	φ6.3 × 6L	φ6.3 × 9L	φ6.3 × 10.5L	φ8 × 7L	φ8 × 9L	φ8 × 12L	φ10 × 8L	φ10 × 10L	φ10 × 13L
φD	6.3	6.3	6.3	8.0	8.0	8.0	10.0	10.0	10.0
L	5.5	8.5	10.0	6.5	8.5	11.5	7.5	9.5	12.5
P	2.5	2.5	2.5	3.5	3.5	3.5	5.0	5.0	5.0
φd	0.45	0.6	0.5	0.6	0.6	0.6	0.6	0.6	0.6

(mm) Voltage

V	2.5	4	6.3	10	16	20	25
Code	e	g	j	A	C	D	E

● Frequency coefficient of rated ripple current

Frequency	120Hz	1kHz	10kHz	100kHz or more
Coefficient	0.05	0.30	0.70	1.00

Please refer to the Guidelines for Aluminum Electrolytic Capacitors for end seal configuration information.

● Dimension table in next page.

PLF

■ Dimensions

Rated Voltage (V) (code)	Surge Voltage (V)	Rated Capacitance (μF)	Case Size φD × L (mm)	tan δ	Leakage Current (μA) (at 20°C after 2 minutes)	ESR (mΩ) (20°C/100kHz)	Rated Ripple (mA <sub>rms</sub> ) (105°C/100kHz)	Part Number
2.5 (0E)	2.8	330	○ 6.3 × 9	0.08	500	7	5600	PLF0E331MCO8
		390	■ 6.3 × 10.5	0.08	195	20	3200	PLF0E391MDL4
		560	○ 6.3 × 9	0.08	500	7	5600	PLF0E561MCO8
		560	8 × 9	0.08	280	6	4800	PLF0E561MCO1
		680	▲ 8 × 9	0.08	340	7	4800	PLF0E681MCO6
		680	8 × 12	0.08	340	6	5700	PLF0E681MDO1
		820	○ 6.3 × 9	0.08	500	7	5600	PLF0E821MCO8
		820	▲ 8 × 9	0.08	410	7	5200	PLF0E821MCO6
		820	8 × 12	0.08	410	6	6200	PLF0E821MDO1
		1000	10 × 13	0.08	500	6	6500	PLF0E102MDO1
		1200	10 × 13	0.08	600	8	5300	PLF0E122MDO1
		1500	▲ 8 × 12	0.08	750	7	6100	PLF0E152MDO6
1500	10 × 13	0.08	750	8	5500	PLF0E152MDO1		
4 (0G)	4.6	270	○ 6.3 × 9	0.08	500	7	5600	PLF0G271MCO8
		270	■ 6.3 × 10.5	0.08	216	20	3200	PLF0G271MDL4
		390	■ 6.3 × 10.5	0.08	312	24	3300	PLF0G391MDL4
		560	▲ 8 × 9	0.08	448	7	5200	PLF0G561MCO6
		560	8 × 12	0.08	448	7	5500	PLF0G561MDO1
		680	8 × 12	0.08	544	6	6200	PLF0G681MDO1
		820	10 × 13	0.08	656	6	6500	PLF0G821MDO1
		1000	10 × 13	0.08	800	6	6640	PLF0G102MDO1
		1200	10 × 13	0.08	960	8	5600	PLF0G122MDO1
6.3 (0J)	7.2	220	■ 6.3 × 10.5	0.08	277	20	3200	PLF0J221MDL4
		330	■ 6.3 × 10.5	0.08	416	24	3300	PLF0J331MDL4
		470	▲ 8 × 9	0.08	592	7	5200	PLF0J471MCO6
		470	8 × 12	0.08	592	7	5500	PLF0J471MDO1
		680	10 × 13	0.08	857	6	6300	PLF0J681MDO1
10 (1A)	11.5	47	■ 6.3 × 10.5	0.08	94	25	2900	PLF1A470MDL4
		68	■ 6.3 × 10.5	0.08	136	25	2900	PLF1A680MDL4
		100	■ 6.3 × 10.5	0.08	200	25	2900	PLF1A101MDL4
		150	■ 6.3 × 10.5	0.08	300	25	2900	PLF1A151MDL4
		270	8 × 12	0.08	540	8	4900	PLF1A271MDO1
		470	10 × 13	0.08	940	7	5700	PLF1A471MDO1
		560	10 × 13	0.08	1120	7	5900	PLF1A561MDO1
		680	10 × 13	0.08	1360	7	6100	PLF1A681MDO1
16 (1C)	18.4	100	■ 6.3 × 10.5	0.08	320	24	2900	PLF1C101MDL4
		180	8 × 12	0.08	576	9	5000	PLF1C181MDO1
		270	8 × 12	0.08	864	9	5100	PLF1C271MDO1
		330	10 × 13	0.08	1056	9	6100	PLF1C331MDO1
		470	10 × 13	0.08	1504	9	6100	PLF1C471MDO1
20 (1D)	23	22	△ 6.3 × 6	0.12	88	50	1700	PLF1D220MCL2
		39	△ 8 × 7	0.12	156	45	2000	PLF1D390MCL2
		47	△ 8 × 7	0.12	188	45	2000	PLF1D470MCL2
		56	△ 10 × 8	0.12	224	40	2400	PLF1D560MCL2
		68	△ 10 × 8	0.12	272	40	2600	PLF1D680MCL2
		82	△ 10 × 8	0.12	328	40	2600	PLF1D820MCL2
		100	△ 8 × 12	0.12	400	22	3320	PLF1D101MDO2
		120	△ 10 × 10	0.12	480	35	2800	PLF1D121MCL2
		150	△ 10 × 13	0.12	600	20	4320	PLF1D151MDO2
25 (1E)	28.7	6.8	△ 6.3 × 6	0.12	85	80	1200	PLF1E6R8MCL2
		10	□ 6.3 × 6	0.12	125	65	1500	PLF1E100MCL7
		10	△ 8 × 7	0.12	125	60	1500	PLF1E100MCL2
		22	□ 8 × 7	0.12	275	50	1800	PLF1E220MCL7
		47	△ 10 × 13	0.12	588	30	3000	PLF1E470MDO2
		56	△ 10 × 13	0.12	700	28	3800	PLF1E560MDO2

No marked, ① will be put at 12th digit of type numbering system.  
 △ : In this case, ② will be put at 12th digit of type numbering system.  
 ■ : In this case, ④ will be put at 12th digit of type numbering system.

▲ : In this case, ⑥ will be put at 12th digit of type numbering system.  
 □ : In this case, ⑦ will be put at 12th digit of type numbering system.  
 ○ : In this case, ⑧ will be put at 12th digit of type numbering system.

• For formed lead or taped product specifications and minimum order quantity, please refer to the Guidelines for Aluminum Electrolytic Capacitors.

CAT.8100M

## PLG Radial Lead Type, Higher Capacitance



- Higher Capacitance, Low ESR, High ripple current.
- Load life of 2000 hours at 105°C.
- Radial lead type :  
Lead free flow soldering condition correspondence
- Compliant to the RoHS directive (2011/65/EU,(EU)2015/863).

**PLG**



### Specifications

Item	Performance Characteristics									
Category Temperature Range	-55 to +105°C									
Rated Voltage Range	2.5 to 16V									
Rated Capacitance Range	330 to 3900μF									
Capacitance Tolerance	±20% at 120Hz, 20°C									
Tangent of loss angle (tan δ)	Less than or equal to the specified value at 120Hz, 20°C									
ESR (※ 1)	Less than or equal to the specified value at 100kHz, 20°C									
Leakage Current (※ 2)	Less than or equal to the specified value. After 2 minutes' application of rated voltage at 20°C									
Temperature Characteristics (Max.Impedance Ratio)	$Z(+105^{\circ}\text{C}) / Z(+20^{\circ}\text{C}) \leq 1.25$ (100kHz) $Z(-55^{\circ}\text{C}) / Z(+20^{\circ}\text{C}) \leq 1.25$									
Endurance	The specifications listed at right shall be met when the capacitors are restored to 20°C after the rated voltage is applied for 2000 hours at 105°C.	<table border="1"> <tr> <td>Capacitance change</td> <td>Within ± 20% of the initial capacitance value (※ 3)</td> </tr> <tr> <td>tan δ</td> <td>150% or less than the initial specified value</td> </tr> <tr> <td>ESR (※ 1)</td> <td>150% or less than the initial specified value</td> </tr> <tr> <td>Leakage current (※ 2)</td> <td>Less than or equal to the initial specified value</td> </tr> </table>	Capacitance change	Within ± 20% of the initial capacitance value (※ 3)	tan δ	150% or less than the initial specified value	ESR (※ 1)	150% or less than the initial specified value	Leakage current (※ 2)	Less than or equal to the initial specified value
Capacitance change	Within ± 20% of the initial capacitance value (※ 3)									
tan δ	150% or less than the initial specified value									
ESR (※ 1)	150% or less than the initial specified value									
Leakage current (※ 2)	Less than or equal to the initial specified value									
Damp Heat (Steady State)	The specifications listed at right shall be met when the capacitors are restored to 20°C after the rated voltage is applied for 1000 hours at 60°C, 90% RH.	<table border="1"> <tr> <td>Capacitance change</td> <td>Within ± 20% of the initial capacitance value (※ 3)</td> </tr> <tr> <td>tan δ</td> <td>150% or less than the initial specified value</td> </tr> <tr> <td>ESR (※ 1)</td> <td>150% or less than the initial specified value</td> </tr> <tr> <td>Leakage current (※ 2)</td> <td>Less than or equal to the initial specified value</td> </tr> </table>	Capacitance change	Within ± 20% of the initial capacitance value (※ 3)	tan δ	150% or less than the initial specified value	ESR (※ 1)	150% or less than the initial specified value	Leakage current (※ 2)	Less than or equal to the initial specified value
Capacitance change	Within ± 20% of the initial capacitance value (※ 3)									
tan δ	150% or less than the initial specified value									
ESR (※ 1)	150% or less than the initial specified value									
Leakage current (※ 2)	Less than or equal to the initial specified value									
Resistance to Soldering Heat	After soldering the capacitor under the soldering conditions prescribed here as preheat at 150 to 200°C for 60 to 180 seconds and peak temperature at 265°C for 10 seconds or less, the capacitor shall meet the specifications listed at right, provided that its temperature profile is measured at both of terminal ends facing the soldering side.	<table border="1"> <tr> <td>Capacitance change</td> <td>Within ± 10% of the initial capacitance value (※ 3)</td> </tr> <tr> <td>tan δ</td> <td>130% or less than the initial specified value</td> </tr> <tr> <td>ESR (※ 1)</td> <td>130% or less than the initial specified value</td> </tr> <tr> <td>Leakage current (※ 2)</td> <td>Less than or equal to the initial specified value</td> </tr> </table>	Capacitance change	Within ± 10% of the initial capacitance value (※ 3)	tan δ	130% or less than the initial specified value	ESR (※ 1)	130% or less than the initial specified value	Leakage current (※ 2)	Less than or equal to the initial specified value
Capacitance change	Within ± 10% of the initial capacitance value (※ 3)									
tan δ	130% or less than the initial specified value									
ESR (※ 1)	130% or less than the initial specified value									
Leakage current (※ 2)	Less than or equal to the initial specified value									
Marking	Navy blue print on the case top									

※ 1 ESR should be measured at both of the terminal ends closest to the capacitor body.

※ 2 Conditioning : If any doubt arises, measure the leakage current after the voltage treatment of applying DC rated voltage continuously to the capacitor for 120 minutes at 105°C.

※ 3 Initial value : The value before test of examination of resistance to soldering.

### Dimensions

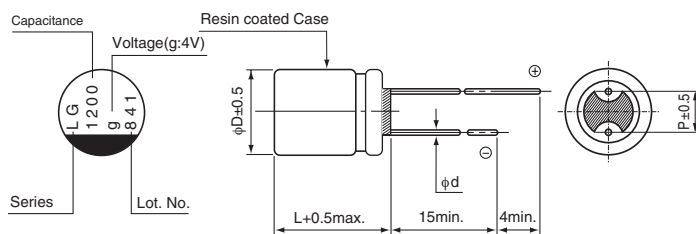

	(mm)		
Size	φ8 × 9L	φ8 × 12L	φ10 × 13L
φD	8.0	8.0	10.0
L	8.5	11.5	12.5
P	3.5	3.5	5.0
φd	0.6	0.6	0.6

Voltage					
V	2.5	4	6.3	10	16
Code	e	g	j	A	C

### Type numbering system (Example : 4V 1200μF)

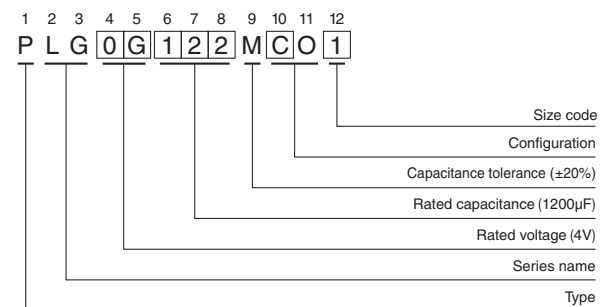

### Frequency coefficient of rated ripple current

Frequency	120Hz	1kHz	10kHz	100kHz or more
Coefficient	0.05	0.30	0.70	1.00

Please refer to the Guidelines for Aluminum Electrolytic Capacitors for end seal configuration information.

● Dimension table in next page.

# PLG

■ Dimensions

Rated Voltage (V) Code	Surge Voltage (V)	Rated Capacitance (μF)	Case Size φD × L (mm)	tan δ	Leakage Current (μA) (at 20°C after 2 minutes)	ESR (mΩ) (20°C/100kHz)	Rated Ripple (mArms) (105°C/100kHz)	Part Number
2.5 (0E)	2.8	1800	8 × 9	0.08	900	9	6000	PLG0E182MCO1
		2200	8 × 12	0.08	1100	8	6700	PLG0E222MDO1
		2700	10 × 13	0.08	1350	8	5560	PLG0E272MDO1
		3900	10 × 13	0.08	1950	8	7000	PLG0E392MDO1
4 (0G)	4.6	1200	8 × 9	0.08	960	9	5900	PLG0G122MCO1
		1800	8 × 12	0.08	1440	9	6500	PLG0G182MDO1
		2700	10 × 13	0.08	2160	8	6900	PLG0G272MDO1
6.3 (0J)	7.2	820	8 × 9	0.08	1033	9	5700	PLG0J821MCO1
		1200	8 × 12	0.08	1512	9	6100	PLG0J122MDO1
		1500	10 × 13	0.08	1890	9	6300	PLG0J152MDO1
		1800	10 × 13	0.08	2268	8	6600	PLG0J182MDO1
10 (1A)	11.5	560	8 × 9	0.08	1120	11	5100	PLG1A561MCO1
		820	8 × 12	0.08	1640	10	5800	PLG1A821MDO1
		1200	10 × 13	0.08	2400	9	6200	PLG1A122MDO1
16 (1C)	18.4	330	8 × 9	0.08	1056	13	4700	PLG1C331MCO1
		470	8 × 12	0.08	1504	11	5400	PLG1C471MDO1
		820	10 × 13	0.08	2624	11	5600	PLG1C821MDO1

• For formed lead or taped product specifications and minimum order quantity, please refer to the Guidelines for Aluminum Electrolytic Capacitors.



**PLS**

Radial Lead Type, Long Life Assurance



- Ultra-low ESR, High ripple current.
- Load life of 5000 hours at 105°C.
- Radial lead type :  
Lead free flow soldering condition correspondence.
- Compliant to the RoHS directive (2011/65/EU,(EU)2015/863).

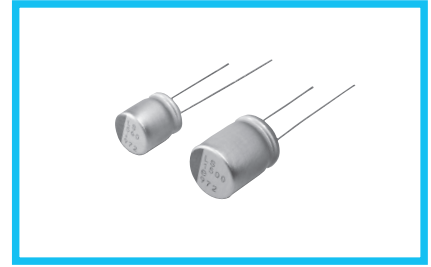

■ Specifications

Item	Performance Characteristics									
Category Temperature Range	-55 to +105°C									
Rated Voltage Range	2.5 to 16V									
Rated Capacitance Range	100 to 1500μF									
Capacitance Tolerance	±20% at 120Hz, 20°C									
Tangent of loss angle (tan δ)	Less than or equal to the specified value at 120Hz, 20°C									
ESR (※ 1)	Less than or equal to the specified value at 100kHz, 20°C									
Leakage Current (※ 2)	Less than or equal to the specified value. After 2 minutes' application of rated voltage at 20°C									
Temperature Characteristics (Max.Impedance Ratio)	$Z(+105^{\circ}\text{C}) / Z(+20^{\circ}\text{C}) \leq 1.25$ (100kHz) $Z(-55^{\circ}\text{C}) / Z(+20^{\circ}\text{C}) \leq 1.25$									
Endurance	The specifications listed at right shall be met when the capacitors are restored to 20°C after the rated voltage is applied for 5000 hours at 105°C.	<table border="1"> <tr><td>Capacitance change</td><td>Within ± 20% of the initial capacitance value (※ 3)</td></tr> <tr><td>tan δ</td><td>150% or less than the initial specified value</td></tr> <tr><td>ESR (※ 1)</td><td>150% or less than the initial specified value</td></tr> <tr><td>Leakage current (※ 2)</td><td>Less than or equal to the initial specified value</td></tr> </table>	Capacitance change	Within ± 20% of the initial capacitance value (※ 3)	tan δ	150% or less than the initial specified value	ESR (※ 1)	150% or less than the initial specified value	Leakage current (※ 2)	Less than or equal to the initial specified value
Capacitance change	Within ± 20% of the initial capacitance value (※ 3)									
tan δ	150% or less than the initial specified value									
ESR (※ 1)	150% or less than the initial specified value									
Leakage current (※ 2)	Less than or equal to the initial specified value									
Damp Heat (Steady State)	The specifications listed at right shall be met when the capacitors are restored to 20°C after the rated voltage is applied for 1000 hours at 60°C, 90% RH.	<table border="1"> <tr><td>Capacitance change</td><td>Within ± 20% of the initial capacitance value (※ 3)</td></tr> <tr><td>tan δ</td><td>150% or less than the initial specified value</td></tr> <tr><td>ESR (※ 1)</td><td>150% or less than the initial specified value</td></tr> <tr><td>Leakage current (※ 2)</td><td>Less than or equal to the initial specified value</td></tr> </table>	Capacitance change	Within ± 20% of the initial capacitance value (※ 3)	tan δ	150% or less than the initial specified value	ESR (※ 1)	150% or less than the initial specified value	Leakage current (※ 2)	Less than or equal to the initial specified value
Capacitance change	Within ± 20% of the initial capacitance value (※ 3)									
tan δ	150% or less than the initial specified value									
ESR (※ 1)	150% or less than the initial specified value									
Leakage current (※ 2)	Less than or equal to the initial specified value									
Resistance to Soldering Heat	After soldering the capacitor under the soldering conditions prescribed here as preheat at 150 to 200°C for 60 to 180 seconds and peak temperature at 265°C for 10 seconds or less, the capacitor shall meet the specifications listed at right, provided that its temperature profile is measured at both of terminal ends facing the soldering side.	<table border="1"> <tr><td>Capacitance change</td><td>Within ± 10% of the initial capacitance value (※ 3)</td></tr> <tr><td>tan δ</td><td>130% or less than the initial specified value</td></tr> <tr><td>ESR (※ 1)</td><td>130% or less than the initial specified value</td></tr> <tr><td>Leakage current (※ 2)</td><td>Less than or equal to the initial specified value</td></tr> </table>	Capacitance change	Within ± 10% of the initial capacitance value (※ 3)	tan δ	130% or less than the initial specified value	ESR (※ 1)	130% or less than the initial specified value	Leakage current (※ 2)	Less than or equal to the initial specified value
Capacitance change	Within ± 10% of the initial capacitance value (※ 3)									
tan δ	130% or less than the initial specified value									
ESR (※ 1)	130% or less than the initial specified value									
Leakage current (※ 2)	Less than or equal to the initial specified value									
Marking	Navy blue print on the case top									

- ※ 1 ESR should be measured at both of the terminal ends closest to the capacitor body.
- ※ 2 Conditioning : If any doubt arises, measure the leakage current after the voltage treatment of applying DC rated voltage continuously to the capacitor for 120 minutes at 105°C.
- ※ 3 Initial value : The value before test of examination of resistance to soldering.

■ Dimensions

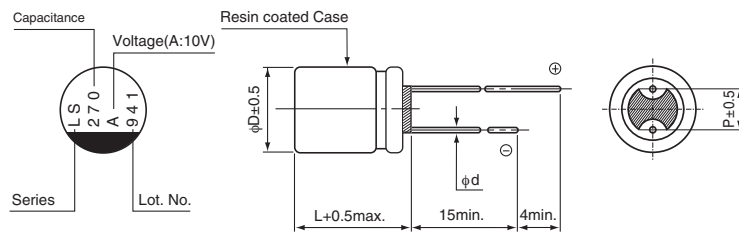

Type numbering system (Example : 10V 270μF)

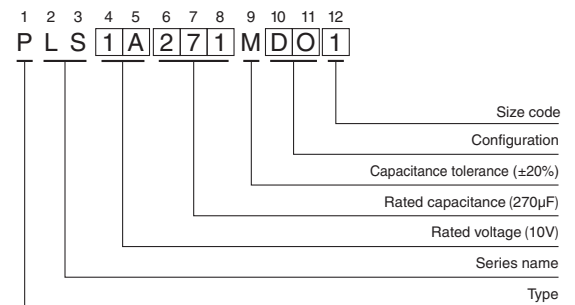

	(mm)					
Size	φ6.3 × 9L	φ6.3 × 10.5L	φ8 × 7L	φ8 × 9L	φ8 × 12L	φ10 × 13L
φD	6.3	6.3	8.0	8.0	8.0	10.0
L	8.5	10.0	6.5	8.5	11.5	12.5
P	2.5	2.5	3.5	3.5	3.5	5.0
φd	0.6	0.5	0.6	0.6	0.6	0.6

Voltage	Voltage				
V	2.5	4	6.3	10	16
Code	e	g	j	A	C

● Frequency coefficient of rated ripple current

Frequency	120Hz	1kHz	10kHz	100kHz or more
Coefficient	0.05	0.30	0.70	1.00

Please refer to the Guidelines for Aluminum Electrolytic Capacitors for end seal configuration information.

● Dimension table in next page.

# PLS

■ Dimensions

Rated Voltage (V) code	Surge Voltage (V)	Rated Capacitance (μF)	Case Size φD × L (mm)	tan δ	Leakage Current (μA) (at 20°C after 2 minutes)	ESR (mΩ) (20°C/100kHz)	Rated Ripple (mArms) (105°C/100kHz)	Part Number
2.5 (0E)	2.8	330	○ 6.3 × 9	0.08	500	8	4800	PLS0E331MCO8
		680	△ 8 × 7	0.08	340	15	3900	PLS0E681MCL2
		820	○ 6.3 × 9	0.08	500	8	4800	PLS0E821MCO8
		820	▲ 8 × 9	0.08	410	7	5200	PLS0E821MCO6
		820	8 × 12	0.08	410	7	5800	PLS0E821MDO1
		1500	10 × 13	0.08	750	8	5500	PLS0E152MDO1
4 (0G)	4.6	270	○ 6.3 × 9	0.08	500	8	4800	PLS0G271MCO8
		560	△ 8 × 7	0.08	448	15	3900	PLS0G561MCL2
		560	▲ 8 × 9	0.08	448	7	5200	PLS0G561MCO6
		680	8 × 12	0.08	544	7	5800	PLS0G681MDO1
		1200	10 × 13	0.08	960	8	5500	PLS0G122MDO1
6.3 (0J)	7.2	330	■ 6.3 × 10.5	0.08	416	20	3000	PLS0J331MDL4
		390	△ 8 × 7	0.08	491	15	3900	PLS0J391MCL2
		470	8 × 12	0.08	592	7	5500	PLS0J471MDO1
		560	○ 6.3 × 9	0.08	706	9	4300	PLS0J561MCO8
		560	▲ 8 × 9	0.08	706	8	5000	PLS0J561MCO6
		820	10 × 13	0.08	1033	8	5500	PLS0J821MDO1
10 (1A)	11.5	150	■ 6.3 × 10.5	0.08	300	20	3000	PLS1A151MDL4
		270	8 × 12	0.08	540	8	4900	PLS1A271MDO1
		470	10 × 13	0.08	940	8	5500	PLS1A471MDO1
16 (1C)	18.4	100	■ 6.3 × 10.5	0.08	320	24	2800	PLS1C101MDL4
		270	8 × 12	0.08	864	9	4500	PLS1C271MDO1
		330	10 × 13	0.08	1056	9	4700	PLS1C331MDO1
		470	10 × 13	0.08	1504	9	4700	PLS1C471MDO1

No marked, [1] will be put at 12th digit of type numbering system.  
 △ : In this case, [2] will be put at 12th digit of type numbering system.  
 ■ : In this case, [4] will be put at 12th digit of type numbering system.  
 ▲ : In this case, [6] will be put at 12th digit of type numbering system.  
 ○ : In this case, [8] will be put at 12th digit of type numbering system.

• For formed lead or taped product specifications and minimum order quantity, please refer to the Guidelines for Aluminum Electrolytic Capacitors.

**PLX** Radial Lead Type, Long Life Assurance



- High reliability, High voltage (to 50V).
- Low ESR, High ripple current.
- Long life of 3000 hours at 125°C.
- Radial lead type:
  - Lead free flow soldering condition correspondence.
- Compliant to the RoHS directive (2011/65/EU,(EU)2015/863).
- AEC-Q200 Qualified. Please contact us for details.

■ Specifications

Item	Performance Characteristics		
Category Temperature Range	-55 to +125°C		
Rated Voltage Range	16 to 50V		
Rated Capacitance Range	22 to 390µF		
Capacitance Tolerance	±20% at 120Hz, 20°C		
Tangent of loss angle (tan δ)	Less than or equal to the specified value at 120Hz, 20°C		
ESR (※ 1)	Less than or equal to the specified value at 100kHz, 20°C		
Leakage Current (※ 2)	Less than or equal to the specified value. After 2 minutes' application of rated voltage at 20°C		
Temperature Characteristics (Max.Impedance Ratio)	$Z(+125^{\circ}\text{C}) / Z(+20^{\circ}\text{C}) \leq 1.25$ (100kHz) $Z(-55^{\circ}\text{C}) / Z(+20^{\circ}\text{C}) \leq 1.25$		
Endurance	The specifications listed at right shall be met when the capacitors are restored to 20°C after the rated voltage is applied for 3000 hours at 125°C.	Capacitance change	Within ± 20% of initial value (※3)
		tan δ	150% or less of the initial specified value
		ESR (※ 1)	150% or less of the initial specified value
		Leakage current (※ 2)	Less than or equal to the initial specified value
Damp Heat (Steady State)	The specifications listed at right shall be met when the capacitors are restored to 20°C after the rated voltage is applied for 1000 hours at 60°C, 90% RH.	Capacitance change	Within ± 20% of initial value (※3)
		tan δ	150% or less of the initial specified value
		ESR (※ 1)	150% or less of the initial specified value
		Leakage current (※ 2)	Less than or equal to the initial specified value
Resistance to Soldering Heat	After soldering the capacitor under the soldering conditions prescribed here as preheat at 150 to 200°C for 60 to 180 seconds and peak temperature at 265°C for 10 seconds or less, the capacitor shall meet the specifications listed at right, provided that its temperature profile is measured at both of terminal ends facing the soldering side.	Capacitance change	Within ± 10% of the initial capacitance value (※3)
		tan δ	130% or less than the initial specified value
		ESR (※ 1)	130% or less than the initial specified value
		Leakage current (※ 2)	Less than or equal to the initial specified value
Marking	Navy blue print on the case top		

- ※ 1 ESR should be measured at both of the terminal ends closest to the capacitor body.
- ※ 2 Conditioning : If any doubt arises, measure the leakage current after the voltage treatment of applying DC rated voltage continuously to the capacitor for 120 minutes at 105°C.
- ※ 3 Initial value : The value before test of examination of resistance to soldering.

■ Dimensions

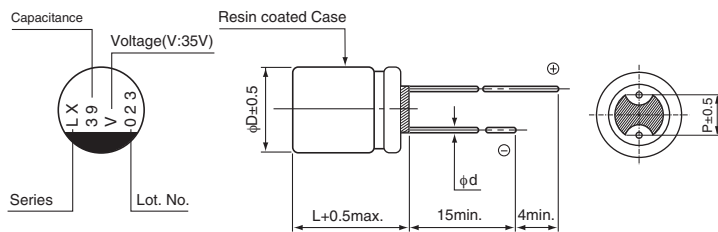

Type numbering system (Example : 35V 39µF)

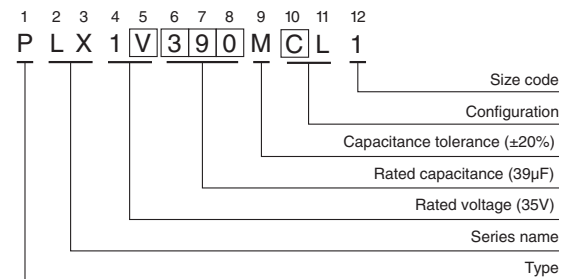

(mm)

Size	φ8 × 9L	φ8 × 12L	φ10 × 13L
φD	8.0	8.0	10.0
L	8.5	11.5	12.5
P	3.5	3.5	5.0
φd	0.6	0.6	0.6

Voltage

V	16	20	25	35	50
Code	C	D	E	V	H

● Frequency coefficient of rated ripple current

Frequency	120Hz	1kHz	10kHz	100kHz or more
Coefficient	0.05	0.30	0.70	1.00

Please refer to the Guidelines for Aluminum Electrolytic Capacitors for end seal configuration information.

● Dimension table in next page.

# PLX

■ Dimensions

Rated Voltage (V)(code)	Surge Voltage (V)	Rated Capacitance (μF)	Case Size φD × L (mm)	tan δ	Leakage Current (μA) (at 20°C after 2 minutes)	ESR (mΩ) (20°C/100kHz)	Rated Ripple (mArms/100kHz)		Part Number
							≤105°C (*3)	105°C < ≤125°C (*3)	
16 (1C)	18.4	150	8 × 9	0.12	480	26	2100	810	PLX1C151MCL1
		220	8 × 12	0.12	704	25	2400	930	PLX1C221MDL1
		390	10 × 13	0.12	1248	23	2900	1130	PLX1C391MDL1
20 (1D)	23.0	120	8 × 9	0.12	480	27	2000	800	PLX1D121MCL1
		150	8 × 12	0.12	600	26	2300	910	PLX1D151MDL1
		270	10 × 13	0.12	1080	24	2800	1110	PLX1D271MDL1
25 (1E)	28.7	82	8 × 9	0.12	410	28	2000	780	PLX1E820MCL1
		120	8 × 12	0.12	600	27	2300	890	PLX1E121MDL1
		180	10 × 13	0.12	900	25	2800	1080	PLX1E181MDL1
35 (1V)	40.2	39	8 × 9	0.12	273	33	1800	720	PLX1V390MCL1
		56	8 × 12	0.12	392	31	2100	830	PLX1V560MDL1
		100	10 × 13	0.12	700	28	2700	1040	PLX1V101MDL1
50 (1H)	57.5	22	8 × 9	0.12	220	35	1800	700	PLX1H220MCL1
		27	8 × 12	0.12	270	33	2000	810	PLX1H270MDL1
		47	10 × 13	0.12	470	29	2600	1020	PLX1H470MDL1

(\*3) Ambient temperature of a capacitor

• For formed lead or taped product specifications and minimum order quantity, please refer to the Guidelines for Aluminum Electrolytic Capacitors.