



# Photocoupler

## Product Data Sheet

### LTV-715F

(M, S, S-TA, S-TA1) series

Spec No.: DS-70-99-0006

Effective Date: 07/28/2016

Revision: C

**LITE-ON DCC**

**RELEASE**

BNS-OD-FC001/A4

## Photocoupler LTV-715F (M, S, S-TA, S-TA1) series

### 1. DESCRIPTION

#### 1.1 Features

- Current transfer ratio ( CTR : MIN. 600% at  $I_F = 1\text{mA}$ ,  $V_{CE} = 2\text{V}$  )
- High input-output isolation voltage ( $V_{ISO}=5,000\text{Vrms}$ )
- Dual-in-line package  
LTV-715F
- Wide lead spacing package  
LTV-715FM
- Surface mounting package  
LTV-715FS
- Tape and reel packaging  
LTV-715FS-TA, LTV-715FS-TA1
- Safety approval
  - \* UL approved (No. E113898)
  - \* TUV approved (No. R9653630)
  - \* CSA approved (No. CA91533-1)
  - \* FIMKO approved (No. 202944)
  - \* NEMKO approved (No. P98101737)
  - \* DEMKO approved (No. 307925)
  - \* SEMKO approved (No. 9833170 / 01)
  - \* VDE approved (No. 094722)
- RoHS Compliance  
All materials be used in device are followed EU RoHS directive (No.2002/95/EC).
- ESD pass HBM 8000V/MM2000V
  
- MSL class1

## Photocoupler LTV-715F (M, S, S-TA, S-TA1) series

### 2. PACKAGE DIMENSIONS

#### 2.1 LTV-715F

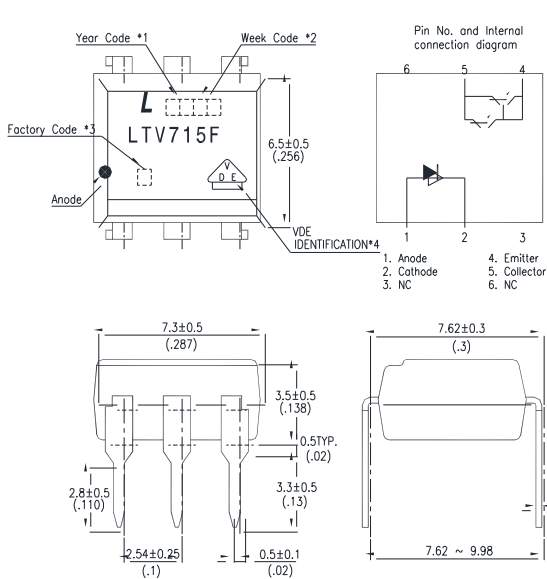

#### 2.2 LTV-715FM

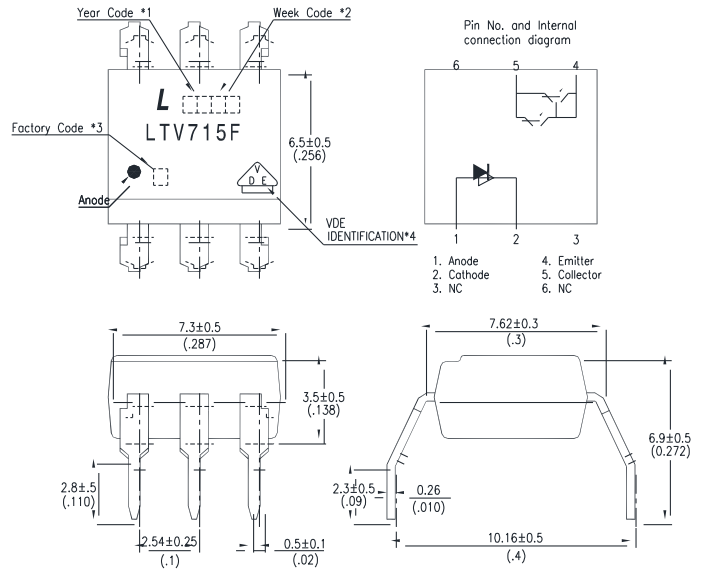

#### 2.3 LTV-715FS

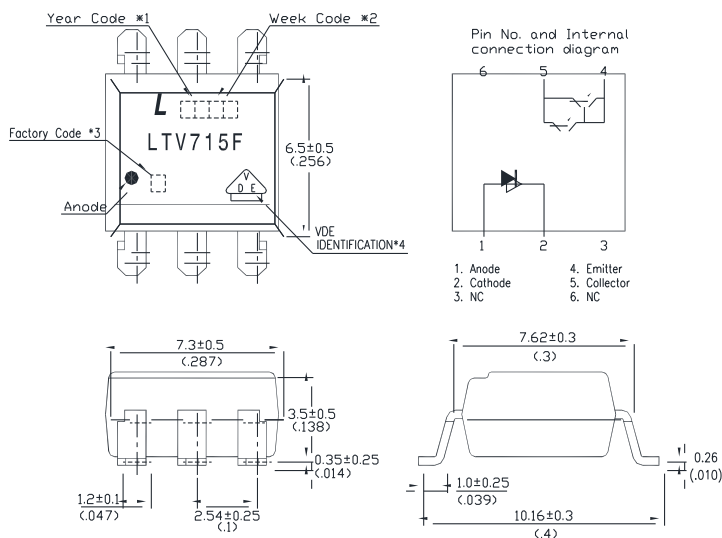

#### Notes :

1. Year date code.
2. 2-digit work week.
3. Factory identification mark shall be marked (Y: Thailand, W: China-CZ).
4. For VDE option.

Dimensions in millimeters (inches)

# Photocoupler LTV-715F (M, S, S-TA, S-TA1) series

## 3. TAPING DIMENSIONS

### 3.1 LTV-715FS-TA

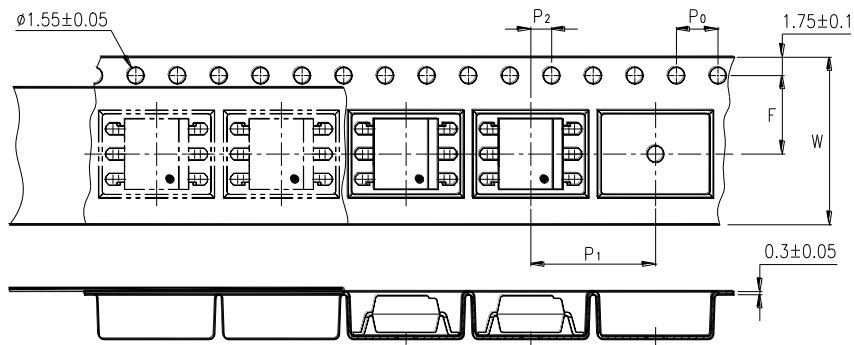

### 3.2 LTV-715FS-TA1

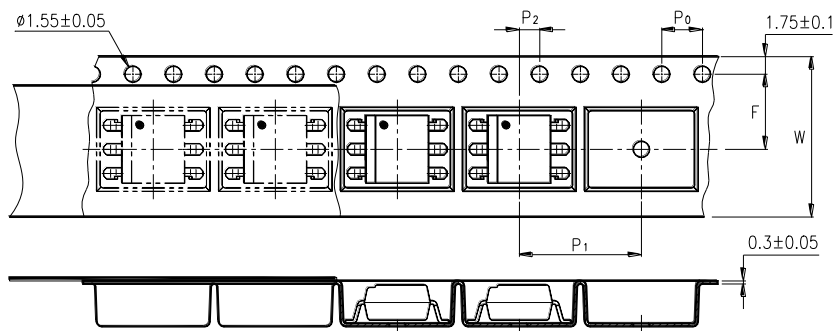

Description	Symbol	Dimension in mm (inch)
Tape wide	W	16±0.3 (0.63)
Pitch of sprocket holes	P <sub>0</sub>	4±0.1 (0.15)
Distance of compartment	F	7.5±0.1 (0.295)
	P <sub>2</sub>	2±0.1 (0.079)
Distance of compartment to compartment	P <sub>1</sub>	12±0.1 (0.472)

### 3.3 Quantities Per Reel

Package Type	TA / TA1
Quantities (pcs)	1000

## Photocoupler LTV-715F (M, S, S-TA, S-TA1) series

### 4. RATING AND CHARACTERISTICS

#### 4.1 Absolute Maximum Ratings at Ta=25°C

	Parameter	Symbol	Rating	Unit
Input	Forward Current	$I_F$	50	mA
	Reverse Voltage	$V_R$	6	V
	Power Dissipation	$P$	70	mW
	Junction Temperature	$T_J$	125	°C
Output	Collector - Emitter Voltage	$V_{CEO}$	35	V
	Emitter - Collector Voltage	$V_{ECO}$	6	V
	Collector Current	$I_C$	80	mA
	Collector Power Dissipation	$P_C$	150	mW
	Total Power Dissipation	$P_{tot}$	170	mW
1.	Isolation Voltage	$V_{iso}$	5000	$V_{rms}$
	Operating Temperature	$T_{opr}$	-25 ~ +100	°C
	Storage Temperature	$T_{stg}$	-40 ~ +125	°C
2.	Soldering Temperature	$T_{sol}$	260	°C

1. AC For 1 Minute, R.H. = 40 ~ 60%

Isolation voltage shall be measured using the following method.

- (1) Short between anode and cathode on the primary side and between collector and emitter on the secondary side.
- (2) The isolation voltage tester with zero-cross circuit shall be used.
- (3) The waveform of applied voltage shall be a sine wave.

2. For 10 Seconds

## Photocoupler LTV-715F (M, S, S-TA, S-TA1) series

### 4.2 ELECTRICAL OPTICAL CHARACTERISTICS at Ta=25°C

Parameter		Symbol	Min.	Typ.	Max.	Unit	Test Condition
Input	Forward Voltage	$V_F$	—	1.2	1.4	V	$I_F=10\text{mA}$
	Reverse Current	$I_R$	—	—	10	$\mu\text{A}$	$V_R=4\text{V}$
	Terminal Capacitance	C	—	30	250	pF	$V=0, f=1\text{MHz}$
Output	Collector Dark Current	$I_{CEO}$	—	—	1000	nA	$V_{CE}=10\text{V}, I_{F5}=0$
	Collector-Emitter Breakdown Voltage	$BV_{CEO}$	35	—	—	V	$I_C=0.1\text{mA}, I_F=0$
	Emitter-Collector Breakdown Voltage	$BV_{ECO}$	6	—	—	V	$I_E=10\mu\text{A}, I_F=0$
Couple	Collector Current	$I_C$	6	16	75	mA	$I_F=1\text{mA}, V_{CE}=2\text{V}$
	1. Current Transfer Ratio	CTR	600	1600	7500	%	
	Collector-Emitter Saturation Voltage	$V_{CE(sat)}$	—	—	1.0	V	$I_F=20\text{mA}$ $I_C=5\text{mA}$
	Isolation Resistance	$R_{ISO}$	$5 \times 10^{10}$	$10^{11}$	—	$\Omega$	DC500V, 40 ~ 60%.R.H.
	Floating Capacitance	$C_f$	—	0.6	1	pF	$V=0, f=1\text{MHz}$
	Cut-Off Frequency	$f_c$	—	6	—	kHz	$V_{CE}=2\text{V}, I_C=20\text{mA}$ $R_L=100\Omega, -3\text{dB}$
	Response Time (Rise)	$t_r$	—	60	250	$\mu\text{s}$	$V_{CE}=2\text{V}, I_C=10\text{mA}$
	Response Time (Fall)	$t_f$	—	53	250	$\mu\text{s}$	$R_L=100\Omega$

$$1. \text{ CTR} = \frac{I_C}{I_F} \times 100\%$$

# Photocoupler LTV-715F (M, S, S-TA, S-TA1) series

## 5. CHARACTERISTICS CURVES

Fig.1 Forward Current vs. Ambient Temperature

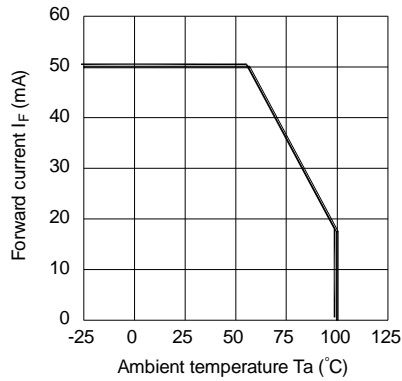

Fig.2 Collector Power Dissipation vs. Ambient Temperature

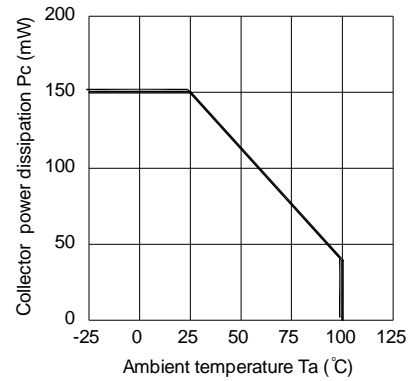

Fig.3 Current Transfer Ratio vs. Forward Current

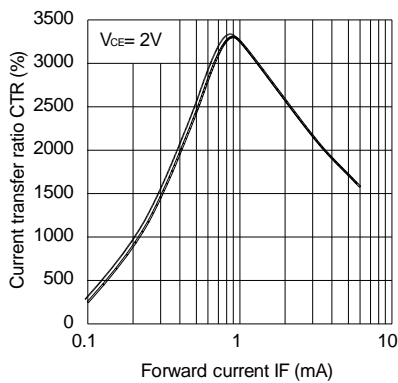

Fig.4 Forward Current vs. Forward Voltage

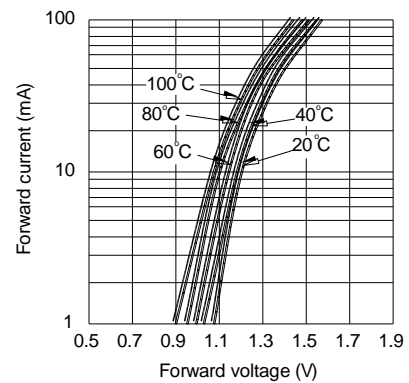

Fig.5 Collector Current vs. Collector-emitter Voltage

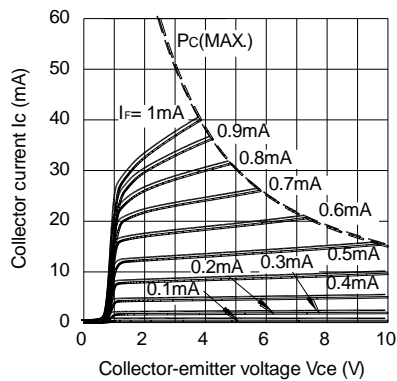
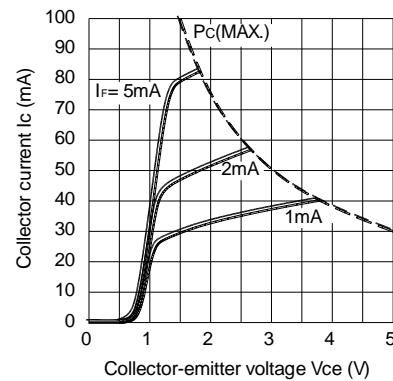

Fig.6 Collector Current vs. Collector-emitter Voltage



## Photocoupler LTV-715F (M, S, S-TA, S-TA1) series

Fig.7 Relative Current Transfer Ratio vs. Ambient Temperature

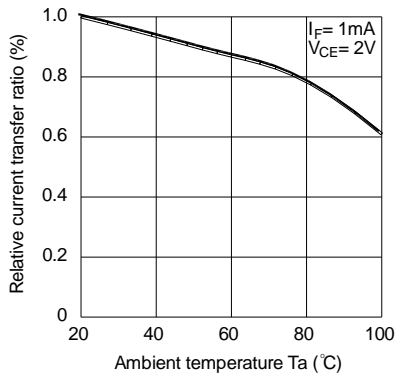

Fig.8 Collector-emitter Saturation Voltage vs. Ambient Temperature

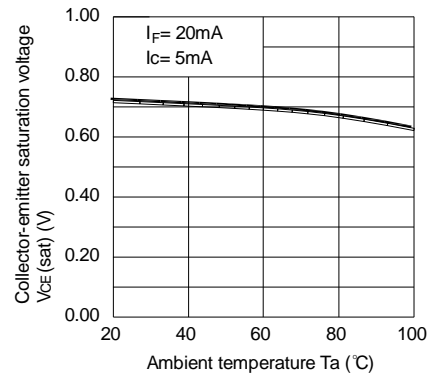

Fig.9 Collector Dark Current vs. Ambient Temperature

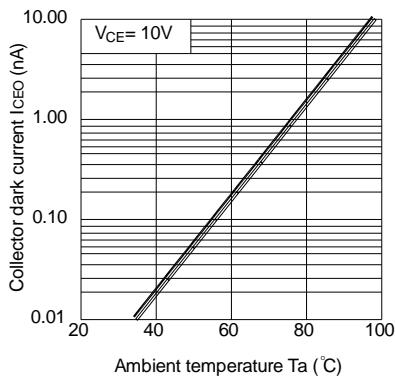

Fig.10 Response Time vs. Load Resistance

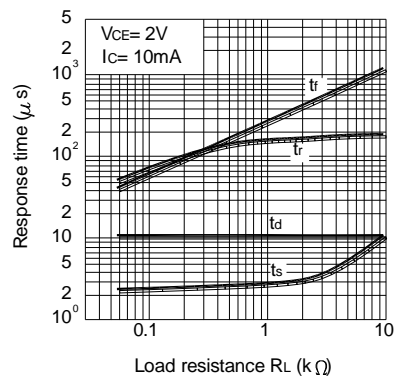
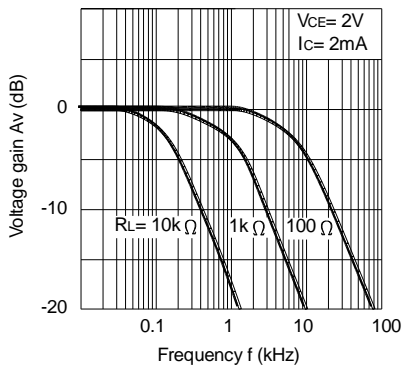
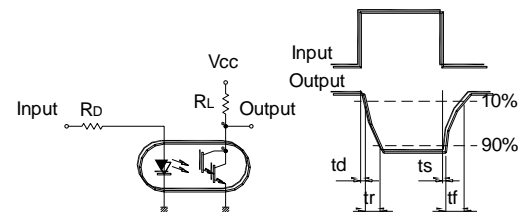

Fig.11 Frequency Response



Test Circuit for Response Time



Test Circuit for Frequency Response

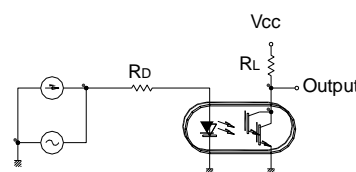



# Photocoupler LTV-715F (M, S, S-TA, S-TA1) series

## 6. TEMPERATURE PROFILE OF SOLDERING

### 6.1 IR Reflow soldering (JEDEC-STD-020C compliant)

One time soldering reflow is recommended within the condition of temperature and time profile shown below. Do not solder more than three times.

Profile item	Conditions
Preheat	
- Temperature Min ( $T_{Smin}$ )	150°C
- Temperature Max ( $T_{Smax}$ )	200°C
- Time (min to max) (ts)	90±30 sec
Soldering zone	
- Temperature ( $T_L$ )	217°C
- Time ( $t_L$ )	60 sec
Peak Temperature ( $T_P$ )	260°C
Ramp-up rate	3°C / sec max.
Ramp-down rate	3~6°C / sec

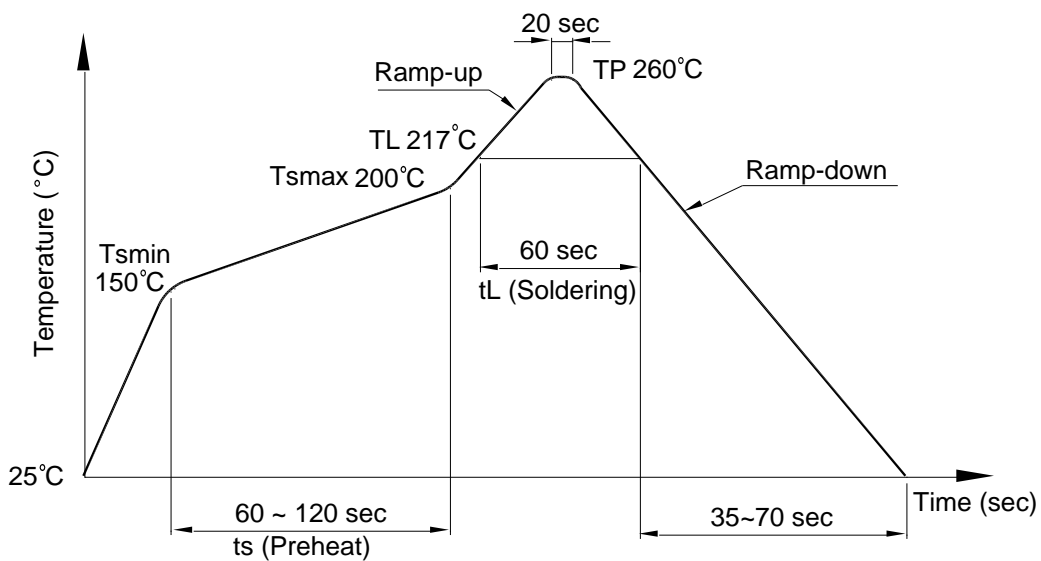

## Photocoupler LTV-715F (M, S, S-TA, S-TA1) series

### 6.2 Wave soldering (JEDEC22A111 compliant)

One time soldering is recommended within the condition of temperature.

Temperature:  $260 \pm 0 / -5^{\circ}\text{C}$

Time: 10 sec.

Preheat temperature: 25 to  $140^{\circ}\text{C}$

Preheat time: 30 to 80 sec.

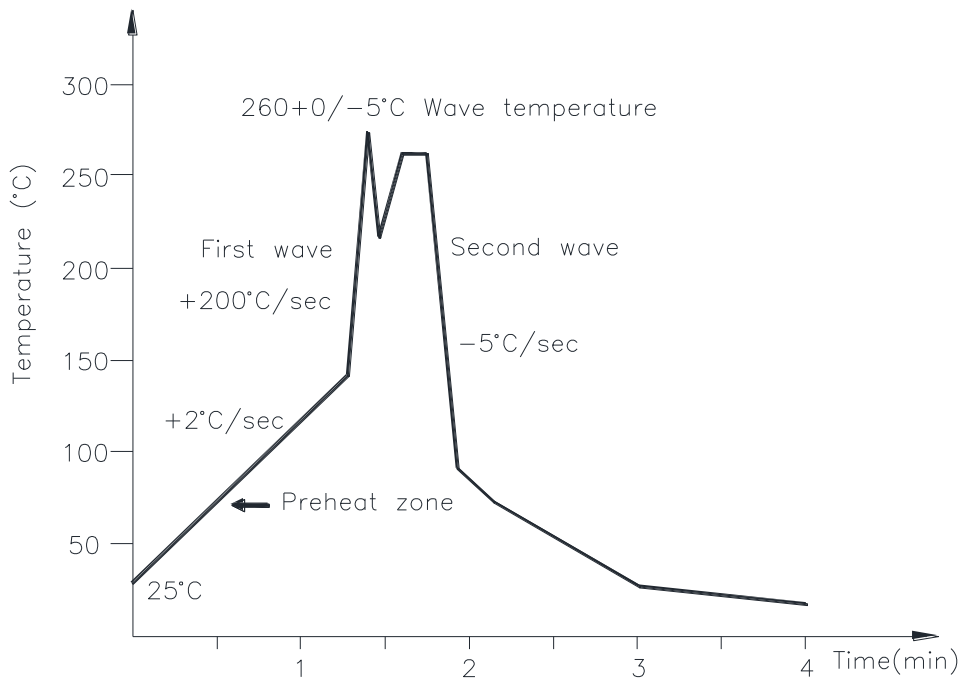

### 6.3 Hand soldering by soldering iron

Allow single lead soldering in every single process. One time soldering is recommended.

Temperature:  $380 \pm 0 / -5^{\circ}\text{C}$

Time: 3 sec max.

**Photocoupler**  
**LTV-715F (M, S, S-TA, S-TA1) series**

**7. RRECOMMENDED FOOT PRINT PATTERNS (MOUNT PAD)**

Unit: mm

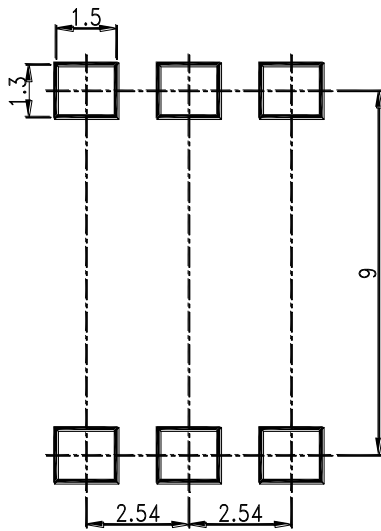

**Photocoupler**  
**LTV-715F (M, S, S-TA, S-TA1) series**

**8. NAMING RULE**

**LTV-715F(1)-(2)**

DEVICE PART NUMBER

- (1) No suffix = Dual-in-Line package
- M = Wide lead spacing package
- S = Surface mounting package

(2) TAPING TYPE (TA, TA1)

Please refer to orientation of taping on Page: 3

Example : LTV-715FS-TA1

**LTV715F(1)(2)-V**

DEVICE PART NUMBER

- (1) No suffix = Dual-in-Line package
- M = Wide lead spacing package
- S = Surface mounting package

(2) TAPING TYPE (TA, TA1)

Please refer to orientation of taping on Page: 3

(3) VDE order option

Example : LTV715FSTA1-V

## Photocoupler LTV-715F (M, S, S-TA, S-TA1) series

### 9. NOTES

- LiteOn is continually improving the quality, reliability, function or design and LiteOn reserves the right to make changes without further notices.
- The products shown in this publication are designed for the general use in electronic applications such as office automation equipment, communications devices, audio/visual equipment, electrical application and instrumentation.
- For equipment/devices where high reliability or safety is required, such as space applications, nuclear power control equipment, medical equipment, etc, please contact our sales representatives.
- When requiring a device for any "specific" application, please contact our sales in advice.
- If there are any questions about the contents of this publication, please contact us at your convenience.
- The contents described herein are subject to change without prior notice.
- Immerge unit's body in solder paste is not recommended.

# Mouser Electronics

Authorized Distributor

Click to View Pricing, Inventory, Delivery & Lifecycle Information:

[Lite-On:](#)

[LTV-715F](#) [LTV-715FM](#) [LTV-715FS-TA1](#) [LTV-715FS-TA](#)