



**C | 16-3<sup>®</sup>**  
**C | 16-L**

**Circular Connectors**



# Note from the CEO



**Ladies and Gentlemen,**

For over 75 years Amphenol has enjoyed success as the interconnection technology provider of choice to industry-leading companies around the world. One of our key strategic areas of focus has been and is the Industrial market. Our organization works with leading manufacturers across a wide range of applications - including Energy Generation & Distribution, Transportation, Heavy Equipment, Factory Automation, Wireless Outdoor, ChipCard Readers - enabling smarter, faster and better technologies to connect products to customer solutions.

The Industrial market footprint of Amphenol covers over facilities in more than 12 different European countries and more than 30 countries worldwide. Our successful expansion into new regions as well as new industrial applications is a direct reflection of our agile, entrepreneurial management team and our unwavering commitment to execute Amphenol's strategies for the benefit of our customers, shareholders and employees.

Thank you for partnering with Amphenol. Our entire organization is at your service.

A handwritten signature in black ink, appearing to read 'R. Adam Norwitt'. The signature is fluid and stylized, with a large initial 'R' and 'A'.

R. Adam Norwitt  
President and CEO, Amphenol Corporation

# Make use of the best

## Use our global resources

“Think global, act local!” Independently from where you are in Europe, we offer you our global expertise and great variety of products and technologies. And in comfort with your personal contact. Our numerous European offices are your access to our global resources.

### ● OUR OFFICES IN EUROPE AND WORLDWIDE

---

FRANCE	CHINA	AUSTRALIA	SOUTH AFRICA
GERMANY	KOREA	MEXICO	INDIA
UNITED KINGDOM	TAIWAN	USA	ITALY

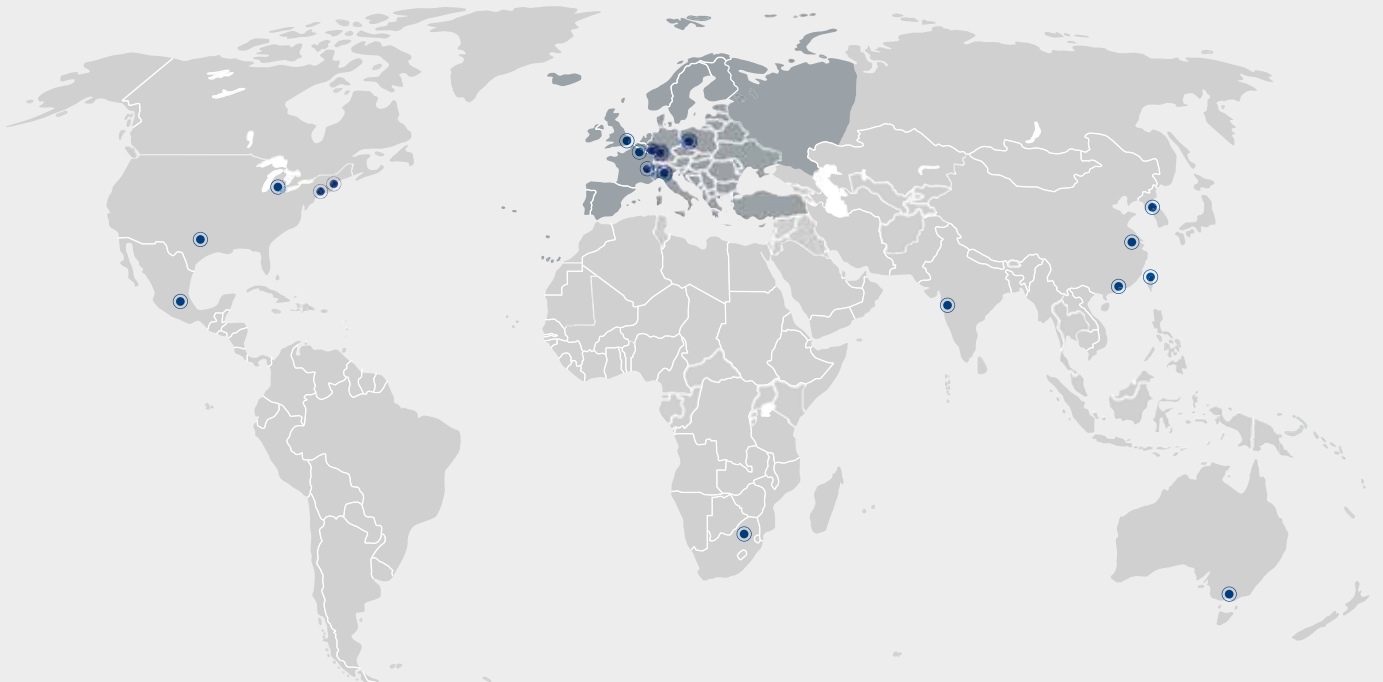



SECURITY, RELIABILITY AND COMFORTABLE SERVICE FROM ONE SOURCE.

# More time for important things: benefit from our service and diversity

Enjoy security, reliability and comfortable service from one source. INDUSTRIAL@AMPHENOL offers one of the most individual and most diversified service programmes in the market – exclusively for industrial customers. Access all possibilities of the Amphenol group through your personal expert adviser.



## WIDE PRODUCT RANGE

Take advantage of a choice of Amphenol products. Our broad product portfolio offers individual solutions from more than 85 member companies in the global Amphenol group.



## EXCLUSIVENESS AND FLEXIBILITY

One face to the customer: every inquiry is handled on an individual service level by your personal key account service partner. This ensures maximum transparency and best-in-class flexibility in the whole process.



## QUALITY

Interconnect systems need reliability, speed and flawless data transmission. We continuously test and guarantee the required standard in our products – and also in our personal services.



## INDIVIDUAL SOLUTIONS

Your project requires an individual solution that is not available off-the-shelf? As your think tank and discussion partner we provide engineering support and solution-oriented development for your tailor-made Amphenol product.



## SPEED AND AVAILABILITY

Smart and intelligent processes are the secret behind our service programme. Flexible planning and distribution, perfect logistics and highest availability are our key factors for best customer service.



## GLOBAL KEY ACCOUNT SERVICE

Our key account service is your individual entrance to global know-how, products and services. More than 85 Amphenol companies around the world offer an extensive range of technologies and products. We offer access to our worldwide resources through one individual contact person.



## Content

## Page

### Serie C 16-3



#### Product description

8

Order information Approvals

9

Kodiersystem

10

Technical data

11

Derating curves

13

View of connector style

14

#### Shell size 1

Male cable connectors

15

Female receptacles

16

Female cable connectors

Male receptacles

17

Accessories

#### Shell size 2

Male cable connectors

18

Female receptacles

Female cable connectors

19

Male receptacles

Accessories

20

#### Special type 2 + PE (Shell size 1)

21

### Serie C 16-3



### Serie C 16-L



#### Special type 4 + PE (Shell size 2)

22

Crimp contacts pin

23

Crimp contacts socket

24

Part No. system for crimp contacts

25

Assembly instruction

26

Technical Information

27

Remarks / Safety classification

30

Summary of Part Numbers

31



## Product description

When there are rough environmental conditions the series C16-3 is in. The program includes a variety of housing types and a wide range of contact arrangements and contact technologies. Solutions up to 900V or 50A can be realized. The housing made of high performance composite material is extremely robust and allows a low weight of the connector. There are versions with the proven screw terminals for easy field installation and crimp versions for cost-effective machine processing. The bayonet quick release allows an easy and reliable handling of the connectors.

## More features and advantages of Serie C16-3

- Up to 20 contacts in one connector
- Hybrid inserts for combined power and signal wires
- Protection degree IP65 in mated position
- Wire gauge up to max. 6mm<sup>2</sup> / AWG10
- Encoding without loss of contact position (on angular position of the insert)
- High-quality molded materials acc. UL94-V0
- VDE, UL and CSA approvals



## C 16-3

Product description  
Order information  
Approvals

### Order information

#### Colour coding

Upon request the coupling ring of the plugs and the housing of the receptacles can be delivered in the colour red, green, blue, yellow and grey.

#### Polarization

Depending on the contact arrangements the polarization of this connector series can be varied. The contact inserts can be mounted in alternate positions. The order number in the catalogue refers always to position 1. The position of the contact inserts can also be changed by the customer using a disassembly tool (see page 17 and 20) to remove the insert and remount it in the required position (see page 10)

#### Crimp version

Order numbers do not include crimp contacts. Please order separately (page 23 / 24)

#### Crimp tooling

Ask for our catalogue "Tools".

### Testhouse

### Approvals

### Approval No.

VDE



3964

UL <sup>1)</sup>



E 63093

CSA



48932

In general approvals refer to representative versions of the connector series and the number of contacts 8, 14, 17 and 12 + 3 for shell size 1 and 5, 12, 14 and 19 for shell size 2. Test report upon request.

<sup>1)</sup>Please refer to the „Conditions of Acceptability“.

**Polarization**

Depending on the contact arrangements the polarization of this connector series can be varied. Please take care of the housing and contact insert characteristics.

Shell size 1			Shell size 2		
No of contacts	No of coding possibil.	Position	No of contacts	No of coding possibil.	Position
3 + PE	4	1,3,5,7	4 + PE	-	-
8 + PE	4	1, 3, 5, 7	5 + PE	6	1, 2, 3, 4, 6, 7
14 + PE	7	1, 2, 3, 4, 5, 6, 7	14 + PE	7	1, 2, 3, 4, 5, 6, 7
17 + PE	6	1, 2, 3, 4, 5, 7	12 + PE	7	1, 2, 3, 4, 5, 6, 7
12 + 3 + PE	4	1, 3, 5, 7	19 + PE	6	1, 3, 4, 5, 6, 7

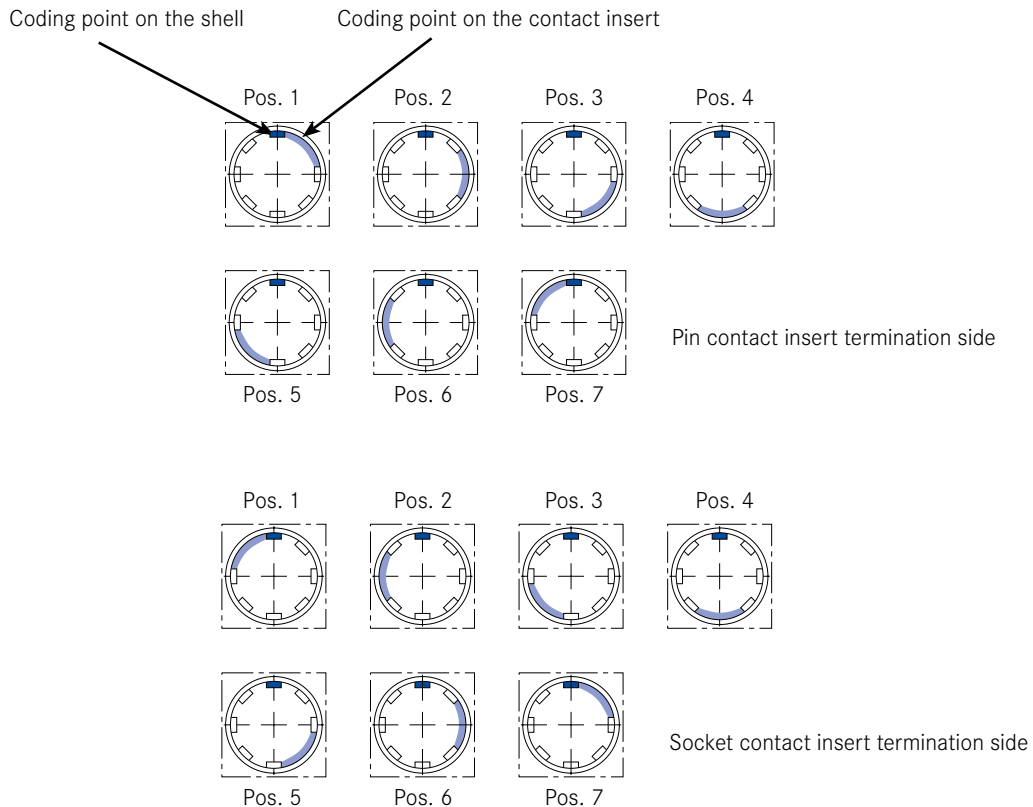

**Disassembly of contact inserts with disassembly tool (see page 17 and 20)**

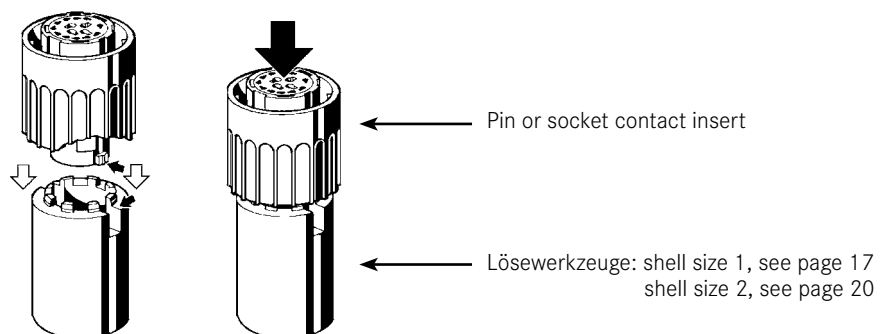

# C 16-3

## Technical data Shell size 1



General Characteristics	Standard	Technical data					
		Shell size 1					
Number of contacts		2 + PE	3 + PE	8 + PE	14 + PE	12 + 3 + PE	17 + PE
View on termination side of male contact insert							
<b>Electrical Characteristics</b>							
Rated voltage	DIN EN 60664-1 <sup>1)</sup>	750 V	900 V	400 V	100 V	3x320V, 12x24V	100 V
	UL 1977, CSA 22.2	-	-	400 V	3x250V, 11x250V	3x250V, 12x24V	250 V
Rated impulse withstand voltage	DIN EN 60664-1 <sup>1)</sup>	6000 V	8000 V	6000 V		3x4000V, 12x800V	3000 V
Pollution degree	DIN EN 60664-1 <sup>1)</sup>	3	3	3	3	3	3
Installation (overvoltage) category	DIN EN 60664-1 <sup>1)</sup>	III	III	III	III	III	III
Material group	DIN EN 60664-1 <sup>1)</sup>	III	II	II	II	II	II
Current carrying capacity at +55°C	DIN EN 60512-5-2, Test 5b	36 A	23 A	12 A	3x 16 A, 11x 6 A	3x 12 A, 12x 6 A	6 A
	UL 1977, CSA 22.2	-	-	10 A	3x 12A, 11x 4A	3x 10 A, 12x 5 A	5 A
Insulation resistance	DIN EN 60512-3-1, Test 3a	≥ 10 <sup>8</sup> Ω					
Contact resistance	DIN EN 60512-2-1, Test 2a	≤ 5 mΩ					
<b>Climatic Characteristics</b>							
Climatic category	DIN EN 60068-1	40 / 125 / 56					
Operating temperature		-40°C ... +125°C					
<b>Mechanical Characteristics</b>							
Degree of protection	DIN EN 60529	IP 65					
Insertion and withdrawal force	DIN EN 60512-13-2, test 13b	≤ 25 N	≤ 30 N	≤ 25 N	≤ 30 N	≤ 25 N	≤ 22 N
Mechanical operation	IEC 60512, test 9a	≥ 500 mating cycles					
<b>Materials</b>							
Housing material		Polyamide 6.6					
Dielectric material		Polyamide 6.6					
Gasket material		Neoprene					
Contact plating		silver plated / gold plated					
<b>Other Characteristics</b>							
Termination technique		crimp					
Wire gauge AWG		1.5-6.0 mm <sup>2</sup> 16 - 10	0.5-4.0 mm <sup>2</sup> 20 - 12	0.14-2.5 mm <sup>2</sup> 26 - 14	0.09-2.5 mm <sup>2</sup> 28 - 14	0.09-2.5 mm <sup>2</sup> 28 - 14	0.09-1.0 mm <sup>2</sup> 28 - 18
Flammability	UL 94	VO					
Locking system		Bajonett					



The stated technical values refer to the use as connector.

If these components are used as plug and socket device a reduced current carrying capacity has to be considered.

# C 16-3

## Technical data Shell size 2



General Characteristics	Standard	Technical data				
		Shell size 1				
Number of contacts		4 + PE	5 + PE	12 + PE	14 + PE	19 + PE
View on termination side of male contact insert						
<b>Electrical Characteristics</b>						
Rated impulse withstand voltage	DIN EN 60664-1 <sup>1)</sup>	600 V	400 V	3 x 500 V, 9 x 300 V	400 V	250 V
	UL 1977, CSA 22.2	-	400 V	3 x 400 V, 9 x 250 V	10 x 400 V, 4 x 250 V	250 V
Rated impulse withstand voltage	DIN EN 60664-1 <sup>1)</sup>	6000 V	6000 V	3 x 6000 V, 9 x 4000 V	6000 V	4000 V
Pollution degree	DIN EN 60664-1 <sup>1)</sup>	3	3	3	3	3
Installation (overvoltage) category	DIN EN 60664-1 <sup>1)</sup>	III	III	III	III	III
Material group	DIN EN 60664-1 <sup>1)</sup>	II	II	II	II	II
Current carrying capacity at +55°C	DIN EN 60512-5-2, Test 5b	36 A	21 A	3 x 21 A, 9 x 11 A	4 x 6 A, 10 x 12 A	6 A
	UL 1977, CSA 22.2	-	16 A	3 x 10 A, 9 x 5 A	10 x 10 A, 4 x 5 A	5 A
Insulation resistance	DIN EN 60512-3-1, Test 3a	≥ 10 <sup>8</sup> Ω				
Contact resistance	DIN EN 60512-2-1, Test 2a	≤ 5 mΩ				
<b>Climatic Characteristics</b>						
Climatic category	DIN EN 60068-1	25 / 100 / 56	40 / 100 / 56	40 / 125 / 56		
Operating temperature		-25°C...+100°C		-40°C ... +125°C (5 + PE: +100°C)		
<b>Mechanical Characteristics</b>						
Degree of protection	DIN EN 60529	IP 65				
Insertion and withdrawal force	DIN EN 60512-13-2, test 13b	≤ 50 N	≤ 15 N	≤ 25 N	≤ 30 N	≤ 25 N
Mechanical operation	DIN EN 60512-9-1, test 9a	≥ 250 mating cycles	≥ 500 mating cycles			
<b>Materials</b>						
Housing material		Polyamide 6.6				
Dielectric material		Polyamide 6.6				
Gasket material		Neoprene				
Contact plating		versilbert / vergoldet				
<b>Other Characteristics</b>						
Termination technique		screw		crimp		
Wire gauge AWG		2.5 - 6.0 mm <sup>2</sup> 14 - 10	4 mm <sup>2</sup> 12	0.09 - 2.5 mm <sup>2</sup> 28 - 14	0.09 - 2.5 mm <sup>2</sup> 28 - 14	0.09 - 1.0 mm <sup>2</sup> 28 - 18
Flammability	UL 94	VO				
Locking system		bayonet				



The stated technical values refer to the use as connector.

If these components are used as plug and socket device a reduced current carrying capacity has to be considered.

Shell size 1

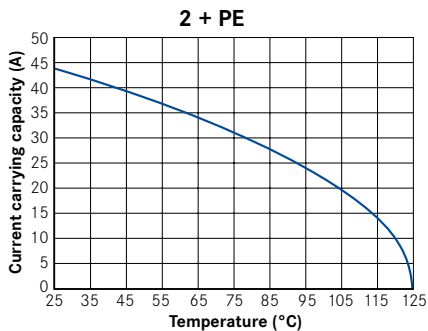

all contacts  $\varnothing$  2,5 mm  
Pin 4mm<sup>2</sup> - Socket 6mm<sup>2</sup>

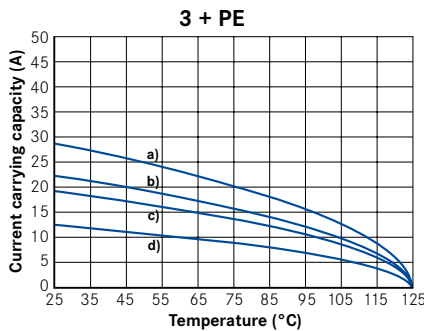

all contacts  $\varnothing$  2,5 mm  
a) wire 4,0 mm<sup>2</sup>      c) wire 1,5 mm<sup>2</sup>  
b) wire 2,5 mm<sup>2</sup>      d) wire 0,5 mm<sup>2</sup>

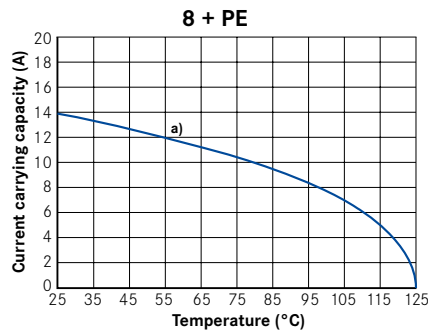

all contacts  $\varnothing$  1,6 mm  
a) wire gauge 1,5 mm<sup>2</sup>

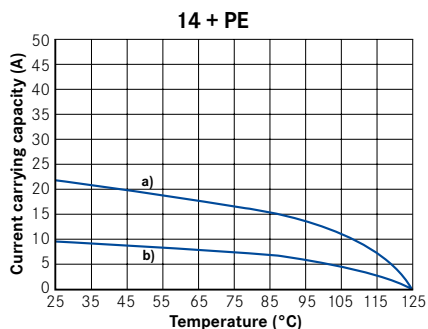

a) 4 contacts  $\varnothing$  2,5 mm, wire gauge 1,5 mm<sup>2</sup>  
b) 11 contacts  $\varnothing$  1,5 mm, wire gauge 0,5 mm<sup>2</sup>

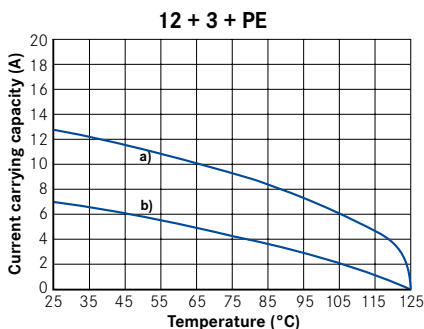

a) 4 contacts  $\varnothing$  1,6 mm, wire gauge 1,5 mm<sup>2</sup>  
b) 12 contacts  $\varnothing$  1,5mm, wire gauge 0,5 mm<sup>2</sup>

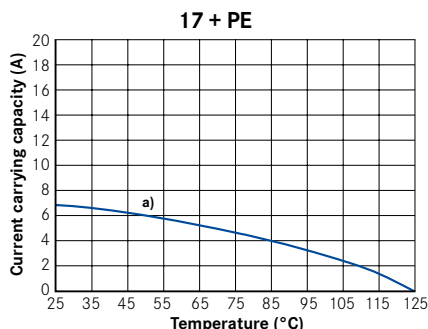

all contacts  $\varnothing$  1,5 mm  
a) wire gauge 0,5 mm<sup>2</sup>

Shell size 2

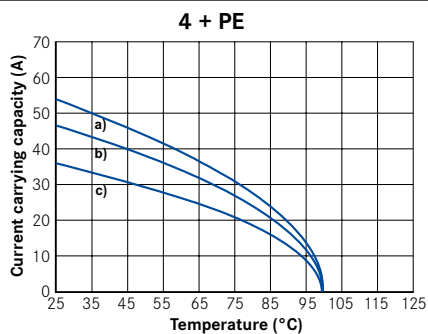

all contacts  $\varnothing$  2,5 mm  
a) 4 contacts loaded 6mm<sup>2</sup>    b) 4 contacts loaded 4mm<sup>2</sup>  
c) 4 contacts loaded 2,5mm<sup>2</sup>

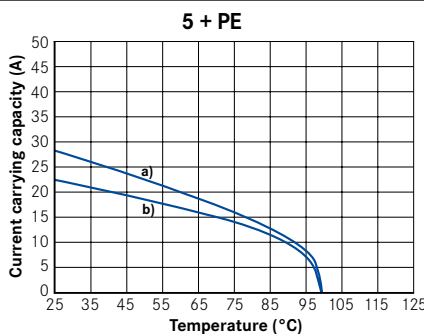

all contacts  $\varnothing$  2,5 mm  
a) wire gauge 4,0 mm<sup>2</sup>  
b) wire gauge 2,5 mm<sup>2</sup>

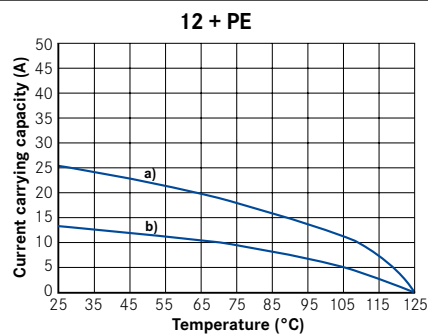

a) 4 contacts  $\varnothing$  2,5 mm, wire gauge 2,5 mm<sup>2</sup>  
b) 9 contacts  $\varnothing$  1,6 mm, wire gauge 2,5 mm<sup>2</sup>

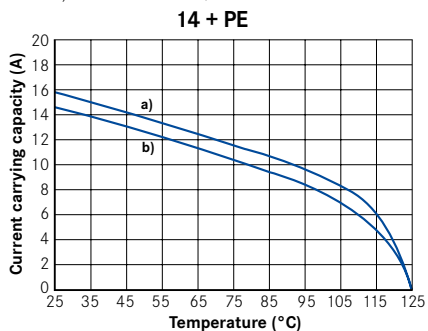

a) 11 contacts  $\varnothing$  1,6 mm, wire gauge 1,5 mm<sup>2</sup>  
b) 4 contacts  $\varnothing$  1,5mm, wire gauge 0,5 mm<sup>2</sup>

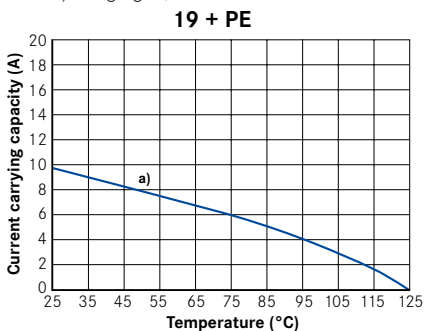

all contacts  $\varnothing$  1,5 mm  
a) wire gauge 0,5 mm<sup>2</sup>

## C 16-3

View of connector style,  
Shell size 1 und 2

C 16-3 Special type, 2 + PE  
see page 21

C 16-L Special type, 4 + PE  
see page 22

Identification	Figure	Description	Conn. Style	Page	
				Size 1	Size 2
Male cable connector		Long version with internal cable clamp	<b>I</b>	15	18
		Short version, with clamping ring	<b>H</b>	15	18
		Right-angled, with clamping ring	<b>K</b>	15	18
Female cable connector		Long version with internal cable clamp	<b>E</b>	16	19
		Short version, with clamping ring	<b>D</b>	16	19
		Right-angled, with clamping ring	<b>F</b>	16	19
Female receptacle		Flange mounting, with mounted gasket	<b>G</b>	16	18
		Panel mounting with ring nut, with gasket	<b>N</b>	16	-
Male receptacle		Flange mounting, with mounted gasket	<b>C</b>	17	19

# C 16-3

## Shell size 1 Male cable connectors



Description	Drawing	No. of cont.	Contacts <sup>2)</sup>	Part No.	
				Cable outlet	
				Ø 10-12	Ø 12-14
Male cable connector for crimp contacts, style I, without contacts <sup>1)</sup> with internal cable clamp		3 + PE	.N 01 025 00...	C016 10I003 002 1	C016 10I003 003 1
		8 + PE	.N 01 016 00...	C016 10I008 002 1	C016 10I008 003 1
		14 + PE	11 x .N 01 015 00... 4 x .N 01 025 00...	C016 10I014 002 1	C016 10I014 003 1
		12+3+PE	12 x .N 01 015 00... 4 x .N 01 016 00...	C016 10I015 002	C016 10I015 003 1
		17 + PE	.N 01 015 00...	C016 10I017 002 1	C016 10I017 003 1
				Cable outlet	
				Ø 8-10	Ø 10-12
Male cable connector for crimp contacts, style H, without contacts <sup>1)</sup> with clamping ring		3 + PE	.N 01 025 00...	C016 10H003 002 1	C016 10H003 003 1
		8 + PE	.N 01 016 00...	C016 10H008 002 1	C016 10H008 003 1
		14 + PE	11 x .N 01 015 00... 4 x .N 01 025 00...	C016 10H014 002 1	C016 10H014 003 1
		12+3+PE	12 x .N 01 015 00... 4 x .N 01 016 00...	C016 10H015 002 1	C016 10H015 003 1
		17 + PE	.N 01 015 00...	C016 10H017 002 1	C016 10H017 003 1
Male cable connector for crimp contacts, style K, without contacts <sup>1)</sup> with clamping ring		3 + PE	.N 01 025 00...	C016 10K003 002 1	C016 10K003 003 1
		8 + PE	.N 01 016 00...	C016 10K008 002 1	C016 10K008 003 1
		14 + PE	11 x .N 01 015 00... 4 x .N 01 025 00...	C016 10K014 002 1	C016 10K014 003 1
		12+3+PE	12 x .N 01 015 00... 4 x .N 01 016 00...	C016 10K015 002 1	C016 10K015 003 1
		17 + PE	.N 01 015 00...	C016 10K017 002 1	C016 10K017 003 1

## C 16-3

### Shell size 1 Female receptacles

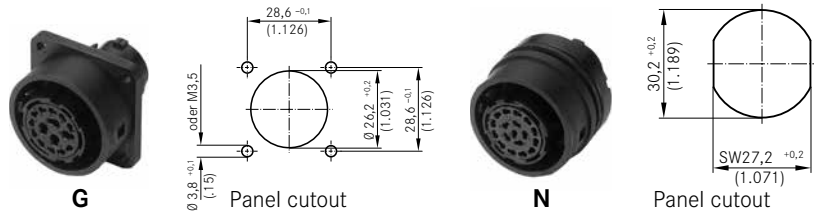

Mounting hole  $\varnothing$  26.2 without conception. Suitable sealing for fixing screws must be provided.

Description	Drawing	No. of cont.	Contacts <sup>2)</sup>	Part No.
Female receptacle for crimp contacts, style G, without contacts <sup>1)</sup>		3 + PE	.N 02 025 00...	C016 10G003 000 1
		8 + PE	.N 02 016 00...	C016 10G008 000 1
		14 + PE	11 x .N 02 015 00... 4 x .N 02 025 00...	C016 10G014 000 1
		12 + 3 + PE	12 x .N 02 015 00... 4 x .N 02 016 00...	C016 10G015 000 1
		17 + PE	.N 02 015 00...	C016 10G017 000 1
Female receptacle for crimp contacts, style N, without contacts <sup>1)</sup>		3 + PE	.N 02 025 00...	C016 10N003 006 1
		8 + PE	.N 02 016 00...	C016 10N008 006 1
		14 + PE	11 x .N 02 015 00... 4 x .N 02 025 00...	C016 10N014 006 1
		12 + 3 + PE	12 x .N 02 015 00... 4 x .N 02 016 00...	C016 10N015 006 1
		17 + PE	.N 02 015 00...	C016 10N017 006 1

## C 16-3

### Shell size 1 Female cable connectors



Description	Drawing	No. of cont.	Contacts <sup>2)</sup>	Part No.	
				Cable outlet $\varnothing$ 10-12	$\varnothing$ 12-14
Female cable connector for crimp contacts, style E, without contacts <sup>1)</sup> , with internal strain relief		3 + PE	.N 02 025 00...	C016 10E003 002 1	C016 10E 003 003 1
		8 + PE	.N 02 016 00...	C016 10E008 002 1	C016 10E008 003 1
		14 + PE	11 x .N 02 015 00... 4 x .N 02 025 00...	C016 10E014 002 1	C016 10E014 003 1
		12 + 3 + PE	12 x .N 02 015 00... 4 x .N 02 016 00...	C016 10E015 002 1	C016 10E015 003 1
		17 + PE	.N 02 015 00...	C016 10E017 002 1	C016 10E017 003 1
Female cable connector for crimp contacts, style D, without contacts <sup>1)</sup> , with clamping ring		3 + PE	.N 02 025 00...	C016 10D003 002 1	C016 10D 003 003 1
		8 + PE	.N 02 016 00...	C016 10D008 002 1	C016 10D008 003 1
		14 + PE	11 x .N 02 015 00... 4 x .N 02 025 00...	C016 10D014 002 1	C016 10D014 003 1
		12 + 3 + PE	12 x .N 02 015 00... 4 x .N 02 016 00...	C016 10D015 002 1	C016 10D015 003 1
		17 + PE	.N 02 015 00...	C016 10D017 002 1	C016 10D017 003 1
Female cable connector for crimp contacts, style F, without contacts <sup>1)</sup> , with clamping ring		3 + PE	.N 02 025 00...	C016 10F003 002 1	C016 10F003 003 1
		8 + PE	.N 02 016 00...	C016 10F008 002 1	C016 10F008 003 1
		14 + PE	11 x .N 02 015 00... 4 x .N 02 025 00...	C016 10F014 002 1	C016 10F014 003 1
		12 + 3 + PE	12 x .N 02 015 00... 4 x .N 02 016 00...	C016 10F015 002 1	C016 10F015 003 1
		17 + PE	.N 02 015 0005	C016 10F017 002 1	C016 10F017 003 1



## C 16-3

### Shell size 1 Male receptacles

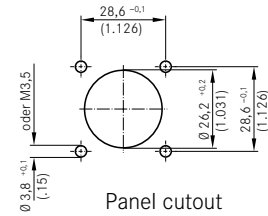

Mounting hole  $\varnothing$  26.2 without conception. Suitable sealing for fixing screws must be provided.

Description	Drawing	No. of cont.	Contacts <sup>2)</sup>	Part No.
Male receptacle for crimp contacts, style C, without contacts <sup>1)</sup>		3 + PE	.N 01 025 00...	C016 10C003 000 1
		8 + PE	.N 01 016 00...	C016 10C008 000 1
		14 + PE	11 x .N 01 015 00... 4 x .N 01 025 00...	C016 10C014 000 1
		12 + 3 + PE	12 x .N 01 015 00... 4 x .N 01 016 00...	C016 10C015 000 1
		17 + PE	.N 01 015 00...	C016 10C017 000 1

## C 16-3

### Shell size 1 Accessories



for male receptacle



for male cable connector

Beschreibung	Maßzeichnung	Part No.	
Protective cap for male cable connector and male receptacle		for male cable connector C016 00U000 001 1	for male receptacle C016 00U000 021 1
Protective cap for female cable connector and female receptacle		for male cable connector C016 00V000 001 1	for male receptacle C016 00V000 021 1
Disassembly tool for pin- and socket inserts		FH 0000-016	

## C 16-3

### Shell size 2 Male cable connectors



Description	Drawing	No. of cont.	Contacts <sup>2)</sup>	Part No.		
				Cable outlet		
				Ø 12-14	Ø 14-16	Ø 19-21
Male cable connector, style I, 5 + PE screw termination, 12 + PE-, 14 + PE and 19 + PE-version without contacts <sup>1)</sup> , with internal strain relief		5 + PE	inkl.	C016 20I005 103 2	C016 20I005 104 2	C016 20I005 105 2
		12 + PE	9 x .N 01 016 00... 4 x .N 01 025 00...	C016 10I012 003 2	C016 10I012 004 2	C016 10I012 005 2
		14 + PE	4 x .N 01 015 00... 11 x .N 01 016 00...	C016 10I014 003 2	C016 10I014 004 2	C016 10I014 005 2
		19 + PE	.N 01 015 000...	C016 10I019 003 2	C016 10I019 004 2	C016 10I019 005 2
				Cable outlet		
				Ø 10-12	Ø 12-14	Ø 14-18
Male cable connector, style H 5 + PE screw termination, 12 + PE-, 14 + PE and 19 + PE-version without contacts <sup>1)</sup> , with clamping ring,		5 + PE	inkl.	C016 20H005 103 2	C016 20H005 104 2	-
		12 + PE	9 x .N 01 016 00... 4 x .N 01 025 00...	C016 10H012 003 2	C016 10H012 004 2	-
		14 + PE	4 x .N 01 015 00... 11 x .N 01 016 00...	C016 10H014 003 2	C016 10H014 004 2	C016 10H014 005 2
		19 + PE	.N 01 015 00...	C016 10H019 003 2	C016 10H019 004 2	-
Male cable connector, style K 5 + PE screw termination, 12 + PE-, 14 + PE and 19 + PE-version without contacts <sup>1)</sup> , with clamping ring		5 + PE	inkl.	-	C016 20K005 104 2	-
		12 + PE	9 x .N 01 016 00... 4 x .N 01 025 00...	-	C016 10K012 004 2	-
		14 + PE	4 x .N 01 015 00... 11 x .N 01 016 00...	-	C016 10K014 004 2	-
		19 + PE	.N 01 015 00...	-	C016 10K019 004 2	-

## C 16-3

### Shell size 2 Female receptacle

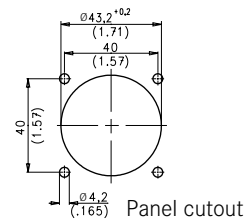

Mounting hole Ø 43.2 without conception. Suitable sealing for fixing screws must be provided.

Description	Drawing	No. of cont.	Contacts <sup>2)</sup>	Part No.
Female receptacle, style G, 5 + PE screw termination, 12 + PE-, 14 + PE and 19 + PE version without contacts <sup>1)</sup>		5 + PE	inkl.	C016 20G005 100 2
		12 + PE	9 x .N 02 016 00... 4 x .N 02 025 00...	C016 10G012 000 2
		14 + PE	4 x .N 02 015 00... 11 x .N 02 016 00...	C016 10G014 000 2
		19 + PE	.N 02 015 00...	C016 10G019 000 2

## C 16-3

### Shell size 2 Female cable connectors



Description	Drawing	No. of cont.	Contacts <sup>2)</sup>	Part No.		
				Cable outlet		
				Ø 12-14	Ø 14-16	Ø 19-21
Female cable connector, style E, 5 + PE screw termination, 12 + PE-, 14 + PE and 19 + PE-version without contacts <sup>1)</sup> , with internal strain relief		5 + PE	incl.	C016 20E005 103 2	C016 20E005 104 2	C016 20E005 105 2
		12 + PE	9 x.N 02 016 00... 4 x.N 02 025 00...	C016 10E012 003 2	C016 10E012 004 2	C016 10E012 005 2
		14 + PE	4 x.N 02 015 00... 11 x.N 02 016 00...	C016 10E014 003 2	C016 10E014 004 2	C016 10E014 005 2
		19 + PE	.N 02 015 00...	C016 10E019 003 2	C016 10E019 004 2	C016 10E019 005 2
				Cable outlet		
				Ø 10-12	Ø 12-14	
Female cable connector, style D 5 + PE screw termination, 12 + PE-, 14 + PE and 19 + PE-version without contacts <sup>1)</sup> , with clamping ring		5 + PE	incl.	C016 20D005 103 2	C016 20D005 104 2	-
		12 + PE	9 x.N 02 016 00... 4 x.N 02 025 00...	C016 10D012 003 2	C016 10D012 004 2	-
		14 + PE	4 x.N 02 015 00... 11 x.N 02 016 00...	C016 10D014 003 2	C016 10D014 004 2	-
		19 + PE	.N 02 015 00...	C016 10D019 003 2	C016 10D019 004 2	-
Female cable connector, style F 5 + PE screw termination, 12 + PE-, 14 + PE and 19 + PE-version without contacts <sup>1)</sup> , with clamping ring		5 + PE	incl.	-	C016 20F005 104 2	-
		12 + PE	9 x.N 02 016 00... 4 x.N 02 025 00...	-	C016 10F012 004 2	-
		14 + PE	4 x.N 02 015 00... 11 x.N 02 016 00...	-	C016 10F014 004 2	-
		19 + PE	.N 02 015 00...	-	C016 10F019 004 2	-

## C 16-3

### Shell size 2 Male receptacle



C

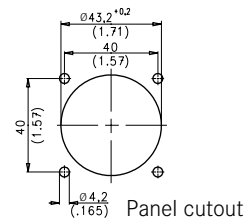

Mounting hole Ø 43.2 without conception. Suitable sealing for fixing screws must be provided.

Description	Drawing	No. of cont.	Contacts <sup>2)</sup>	Part No.
Male receptacle, style C, 5 + PE screw termination, 12 + PE-, 14 + PE and 19 + PE-version without contacts <sup>1)</sup>		5 + PE	incl.	C016 20C005 100 2
		12 + PE	9 x.N 01 016 00... 4 x.N 01 025 00...	C016 10C012 000 2
		14 + PE	4 x.N 01 015 00... 11 x.N 01 016 00...	C016 10C014 000 2
		19 + PE	.N 01 015 00...	C016 10C019 000 2

# C 16-3



## Shell size 2 Accessories



for male  
receptacle

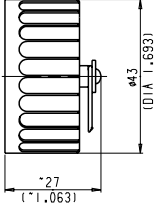
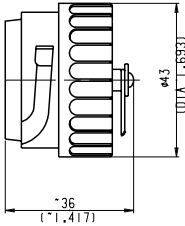

for male  
cable connector

Description	Figure	Part No.	
Protective cap for male cable connector and male receptacle		for male cable connector  C016 00U000 011 2	for male receptacle  C016 00U000 001 2
Protective cap for female cable connector and female receptacle		for female cable connector  C016 00V000 011 2	for female receptacle  C016 00V000 001 2
Disassembly tool for pin-and socket inserts		FH 0002-016	

# C 16-3 2 + PE



Product description	Main features and advantages of Serie C16-3 2 + PE
<p>The C16-3 2 + PE combines the advantages of two contact technologies: screw terminals for quick and easy (field) assembly of the female cable connector as well as economic crimp contacts for the male receptacle, which can be processed automatically. Based on shell size 1 the version with 3 contacts provides an optimized bayonet lock for IP67 in mated position and is also UV-resistant. Because of that the up to 35A and 750V connector is particularly for outside applications e. g. solar.</p>	<ul style="list-style-type: none"> <li>• 2 + PE with screw termination for female cable connector and crimp termination of the male receptacle</li> <li>• Up to 40A (at 40° C) and 750V</li> <li>• Bayonet quick lock</li> <li>• Protection degree IP67 in mated position</li> <li>• Wire gauge 2.5 mm<sup>2</sup> to 6 mm<sup>2</sup> (AWG 14 - 10) for female cable connector and 1.5 mm<sup>2</sup> to 4 mm<sup>2</sup> (AWG 16 - 12) for male receptacle</li> <li>• Cable diameter of 8 to 14mm<sup>2</sup></li> <li>• UV resistant</li> <li>• Optional locking mechanism that prevents an easy opening of the plug connection (Secured Locking)</li> <li>• VDE approval</li> </ul>

Description	Drawing	Polzahl	Contacts <sup>2)</sup>	Part No.		
				8-10mm	10-12mm	12-14mm
Female cable connector		2 + PE	incl.	C016 20E002 801 1	C016 20E002 800 1	C016 20E002 802 1
Male receptable <sup>1)</sup>		2 + PE	.N 01 025 00...	C016 10P002 800 1		



Product description	Main Features
<p>C16-L connectors are based on C16-3 housing size 2 with 5 poles and were developed especially for 3-phase solar inverters. The connectors are designed for up to 50A/600V and offer an optional locking mechanism to avoid unintended release. The screw contacts support a fast and easy assembly in the field. Wire gauge is up to 8,3mm<sup>2</sup> (AWG 8). Another advantage is the compact design with a diameter of only 43mm that allows a comfortable handling of the connector.</p>	<ul style="list-style-type: none"> <li>• 4 + PE for screw termination</li> <li>• Up to 50A (at +40°C) and 600V</li> <li>• Bayonet locking</li> <li>• IP65 when locked</li> <li>• Wire gauges 2.5mm<sup>2</sup> - 8.3mm<sup>2</sup> / AWG 14 - 8</li> <li>• For cable diameter of 11-20mm</li> <li>• UV resistant</li> <li>• Optional locking mechanism</li> <li>• VDE approval</li> </ul>

Description	Drawing	No of contacts	Contacts <sup>2)</sup>	Part No.	
				ohne Verriegelung	mit Verriegelung
Female cable connector Connector Style L		4 + PE	incl.	C016 20E004 800 2	C016 20E004 801 2
Male receptable Connector Style L		4 + PE	incl.	C016 20P004 800 2	C016 20P004 801 2

# 16-3

## Crimp contacts Pin

Stamped single contacts



Stamped contacts on reel  
for hand crimping tools



100 resp. 200 pcs

Stamped contacts on reel for crimp machines



2000 pcs.  
(feeding left or  
right hand side)

Contact Ø in mm	Isulation Ø in mm	No. of cont.	Shell size	Wire gauge in mm <sup>2</sup> / AWG	Supplied as	pcs.	Part No. Contact plating		
							silver	gold	
1.5	0.7 - 1.6	14 + PE	1	0.09 - 0.25 mm <sup>2</sup>	single contact	100	VN 01 015 0052 (1)	VN 01 015 0052 (2)	
		12 + 3 + PE	1	28 - 24	contacts on reel	200	ZN 01 015 0052 (1)	ZN 01 015 0052 (2)	
		17 + PE	1		right	2000	HN 01 015 0052 (1)	HN 01 015 0052 (2)	
		14 + PE	2		left	2000	TN 01 015 0052 (1)	TN 01 015 0052 (2)	
		19 + PE	2						
1.5	1.3 - 2.0	14 + PE	1	0.35 - 0.5 mm <sup>2</sup>	single contact	100	VN 01 015 0046 (1)	VN 01 015 0046 (2)	
		12 + 3 + PE	1	22 - 20	contacts on reel	200	ZN 01 015 0046 (1)	ZN 01 015 0046 (2)	
		17 + PE	1		right	2000	HN 01 015 0046 (1)	HN 01 015 0046 (2)	
		14 + PE	2		left	2000	TN 01 015 0046 (1)	TN 01 015 0046 (2)	
		19 + PE	2						
1.5	1.6 - 2.1	14 + PE	1	0.75 - 1.0 mm <sup>2</sup>	single contact	100	VN 01 015 0047 (1)	VN 01 015 0047 (2)	
		12 + 3 + PE	1	18	contacts on reel	200	ZN 01 015 0047 (1)	ZN 01 015 0047 (2)	
		17 + PE	1		right	2000	HN 01 015 0047 (1)	HN 01 015 0047 (2)	
		14 + PE	2		left	2000	TN 01 015 0047 (1)	TN 01 015 0047 (2)	
		19 + PE	2						
1.6	1.0 - 2.0	8 + PE	1	0.14 - 0.5 mm <sup>2</sup>	single contact	100	VN 01 016 0003 (1)	VN 01 016 0003 (2)	
		12 + 3 + PE	1	26 - 20	contacts on reel	200	ZN 01 016 0003 (1)	ZN 01 016 0003 (2)	
		12 + PE	2		right	2000	HN 01 016 0003 (1)	HN 01 016 0003 (2)	
		14 + PE	2		left	2000	TN 01 016 0003 (1)	TN 01 016 0003 (2)	
1.6	1.8 - 2.8	8 + PE	1	0.5 - 1.5 mm <sup>2</sup>	single contact	100	VN 01 016 0002 (1)	VN 01 016 0002 (2)	
		12 + 3 + PE	1	20 - 16	contacts on reel	100	ZN 01 016 0002 (1)	ZN 01 016 0002 (2)	
		12 + PE	2		right	2000	HN 01 016 0002 (1)	HN 01 016 0002 (2)	
		14 + PE	2		left	2000	TN 01 016 0002 (1)	TN 01 016 0002 (2)	
1.6	2.5 - 3.5	8 + PE	1	1.5 - 2.5 mm <sup>2</sup>	single contact	100	VN 01 016 0005 (1)	VN 01 016 0005 (2)	
		12 + 3 + PE	1	16 - 14	contacts on reel	200	ZN 01 016 0005 (1)	ZN 01 016 0005 (2)	
		12 + PE	2		right	2000	HN 01 016 0005 (1)	HN 01 016 0005 (2)	
		14 + PE	2		left	2000	TN 01 016 0005 (1)	TN 01 016 0005 (2)	
2.5	1.8 - 2.8	3 + PE	1	0,5 - 1,5 mm <sup>2</sup>	single contact	100	VN 01 025 0001 (101)	VN 01 025 0001 (102)	
		14 + PE	1	20 - 16	contacts on reel	100	ZN 01 025 0001 (1)	ZN 01 025 0001 (2)	
		12 + PE	2		right	2000	HN 01 025 0001 (1)	HN 01 025 0001 (2)	
					left	2000	TN 01 025 0001 (1)	TN 01 025 0001 (2)	
	2.5 - 3.5	2 + PE 3 + PE 14 + PE 12 + PE	1	1	1.5 - 2.5 mm <sup>2</sup>	single contact	100	VN 01 025 0010 (101)	VN 01 025 0010 (102)
			1	16 - 14	contacts on reel	200	ZN 01 025 0010 (1)	ZN 01 025 0010 (2)	
			1		right	2000	HN 01 025 0010 (1)	HN 01 025 0010 (2)	
			2		left	2000	TN 01 025 0010 (1)	TN 01 025 0010 (2)	
2.5	3.3 - 4.2	2 + PE	1	2.5 - 4.0mm <sup>2</sup>	single contact	100	VN 01 025 0043(1)		
		3 + PE	1	14-12	contacts on reel	200	ZN 01 025 0043 (1)		
					right	2000	HN 01 025 0043 (1)		
					left	2000	TN 01 025 0043 (1)		

# 16-3

## Crimp contacts Socket

Stamped single contacts



Stamped contacts on reel  
for hand crimping tools



100 resp. 200 pcs

Stamped contacts on reel for crimp machines



2000 pcs.  
(feeding left or  
right hand side)

Contact Ø in mm	Isulation Ø in mm	No. of cont.	Shell size	Wire gauge in mm <sup>2</sup> / AWG	Supplied as	pcs.	Part No. Contact plating	
							silver	gold
1.5	0.7 - 1.6	14 + PE	1	0.09 - 0.25 mm <sup>2</sup>	single contact	100	VN 02 015 0052 (1)	VN 02 015 0052 (2)
		12 + 3 + PE	1	28 - 24	contacts on reel	200	ZN 02 015 0052 (1)	ZN 02 015 0052 (2)
		17 + PE	1		right	2000	HN 02 015 0052 (1)	HN 02 015 0052 (2)
		14 + PE	2		left	2000	TN 02 015 0052 (1)	TN 02 015 0052 (2)
		19 + PE	2					
1.5	1.3 - 2.0	14 + PE	1	0.35 - 0.5 mm <sup>2</sup>	single contact	100	VN 02 015 0046 (1)	VN 02 015 0046 (2)
		12 + 3 + PE	1	22 - 20	contacts on reel	200	ZN 02 015 0046 (1)	ZN 02 015 0046 (2)
		17 + PE	1		right	2000	HN 02 015 0046 (1)	HN 02 015 0046 (2)
		14 + PE	2		left	2000	TN 02 015 0046 (1)	TN 02 015 0046 (2)
		19 + PE	2					
1.5	1.6 - 2.1	14 + PE	1	0.75 - 1.0 mm <sup>2</sup>	single contact	100	VN 02 015 0047 (1)	VN 02 015 0047 (2)
		12 + 3 + PE	1	18	contacts on reel	200	ZN 02 015 0047 (1)	ZN 02 015 0047 (2)
		17 + PE	1		right	2000	HN 02 015 0047 (1)	HN 02 015 0047 (2)
		14 + PE	2		left	2000	TN 02 015 0047 (1)	TN 02 015 0047 (2)
		19 + PE	2					
1.6	1.0 - 2.0	8 + PE	1	0.14 - 0.5 mm <sup>2</sup>	single contact	100	VN 02 016 0003 (1)	VN 02 016 0003 (2)
		12 + 3 + PE	1	26 - 20	contacts on reel	200	ZN 02 016 0003 (1)	ZN 02 016 0003 (2)
		12 + PE	2		right	2000	HN 02 016 0003 (1)	HN 02 016 0003 (2)
		14 + PE	2		left	2000	TN 02 016 0003 (1)	TN 02 016 0003 (2)
1.6	1.8 - 2.8	8 + PE	1	0.5 - 1.5 mm <sup>2</sup>	single contact	100	VN 02 016 0002 (1)	VN 02 016 0002 (2)
		12 + 3 + PE	1	20 - 16	contacts on reel	100	ZN 02 016 0002 (1)	ZN 02 016 0002 (2)
		12 + PE	2		right	2000	HN 02 016 0002 (1)	HN 02 016 0002 (2)
		14 + PE	2		left	2000	TN 02 016 0002 (1)	TN 02 016 0002 (2)
1.6	2.5 - 3.5	8 + PE	1	1.5 - 2.5 mm <sup>2</sup>	single contact	100	VN 02 016 0005 (1)	VN 02 016 0005 (2)
		12 + 3 + PE	1	16 - 14	contacts on reel	200	ZN 02 016 0005 (1)	ZN 02 016 0005 (2)
		12 + PE	2		right	2000	HN 02 016 0005 (1)	HN 02 016 0005 (2)
		14 + PE	2		left	2000	TN 02 016 0005 (1)	TN 02 016 0005 (2)
2.5	1.8 - 2.8	3 + PE	1	0.5 - 1.5 mm <sup>2</sup>	single contact	100	VN 02 025 0001 (101)	VN 02 025 0001 (102)
		14 + PE	1	20 - 16	contacts on reel	100	ZN 02 025 0001 (1)	ZN 02 025 0001 (2)
		12 + PE	2		right	2000	HN 02 025 0001 (1)	HN 02 025 0001 (2)
					left	2000	TN 02 025 0001 (1)	TN 02 025 0001 (2)
	2.5 - 3.5	2 + PE	1	1.5 - 2.5 mm <sup>2</sup>	single contact	100	VN 02 025 0010 (101)	VN 02 025 0010 (102)
		3 + PE	1	16 - 14	contacts on reel	200	ZN 02 025 0010 (1)	ZN 02 025 0010 (2)
		14 + PE	1		right	2000	HN 02 025 0010 (1)	HN 02 025 0010 (2)
		12 + PE	2		left	2000	TN 02 025 0010 (1)	TN 02 025 0010 (2)
2.5	3.3 - 4.2	2 + PE	1	2.5-4.0 mm <sup>2</sup>	single contact	100	VN 02 025 0043 (1)	
		3 + PE	1	14 - 12	contacts on reel	200	ZN 02 025 0043 (1)	
					right	2000	HN 02 025 0043(1)	
					left	2000	TN 02 025 0043 (1)	



**C16-3 Part No. syntax**

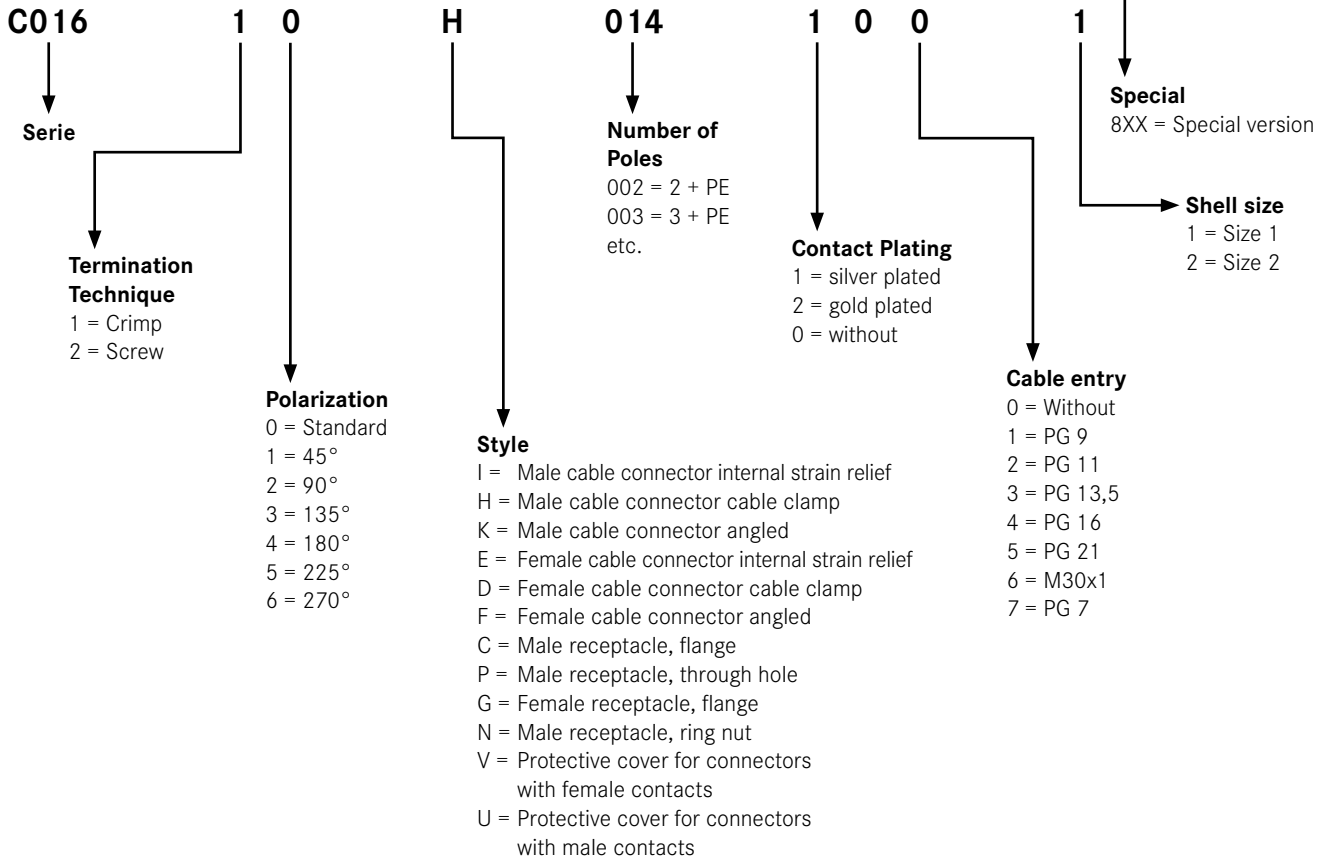

**Part No. syntax contacts**

**VN 01 016 0001 (1)**  
 1) 2) 3) 4) 5)

- 1) supplied as:
  - VN = single contact 100 pcs.
  - ZN = contacts on reel 100 resp. 200 pcs.
  - HN = contacts on reel with 2000 contacts (contact feeding right hand side)
  - TN = contacts on reel with 2000 contacts (contact feeding left hand side)
- 2) Type of contact:
  - 01 = male contact
  - 02 = female contact
- 3) Contact Ø:
  - e. g. 016  $\hat{=}$  1,6 mm
- 4) Connection and wire gauge, e.g.
  - 0052: 0.09 - 0.25 mm<sup>2</sup>
  - 0046: 0.35 - 0.5 mm<sup>2</sup>
  - 0047: 0.75 - 1.0 mm<sup>2</sup>
- 5) Plating:
  - (1) = silver plated
  - (2) = gold plated
  - (4) = gold plated for high performance

**C 16-3**  
Shell size 1 and 2

Torque for back shell and cable screw <sup>1)</sup>  
min. 1 Nm  
max. 2 Nm

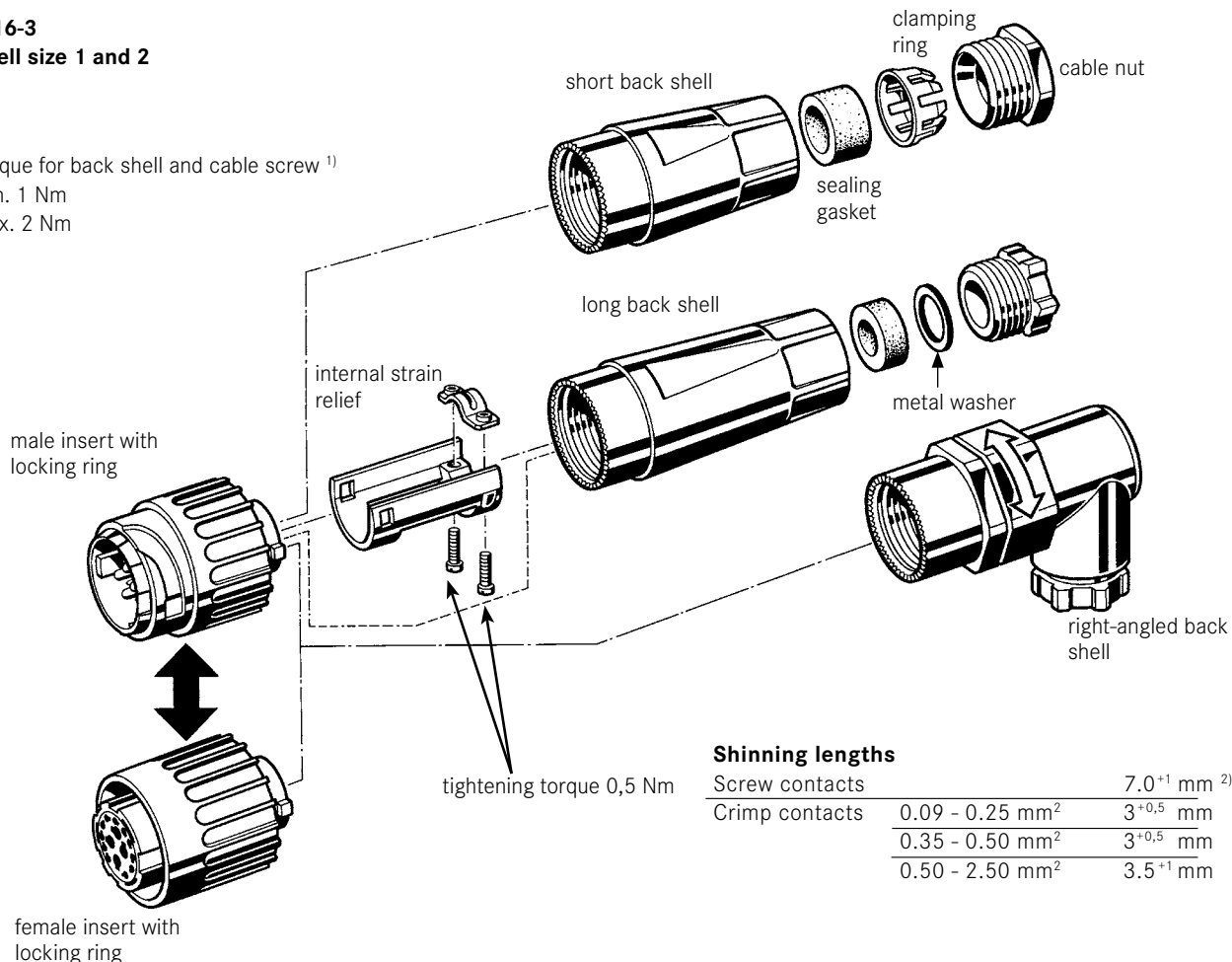

**Shinning lengths**

Screw contacts	7.0 <sup>+1</sup> mm <sup>2)</sup>
Crimp contacts	3 <sup>+0,5</sup> mm
	3 <sup>+0,5</sup> mm
	3.5 <sup>+1</sup> mm

See assembling remarks on page 30.

**C 16-L**

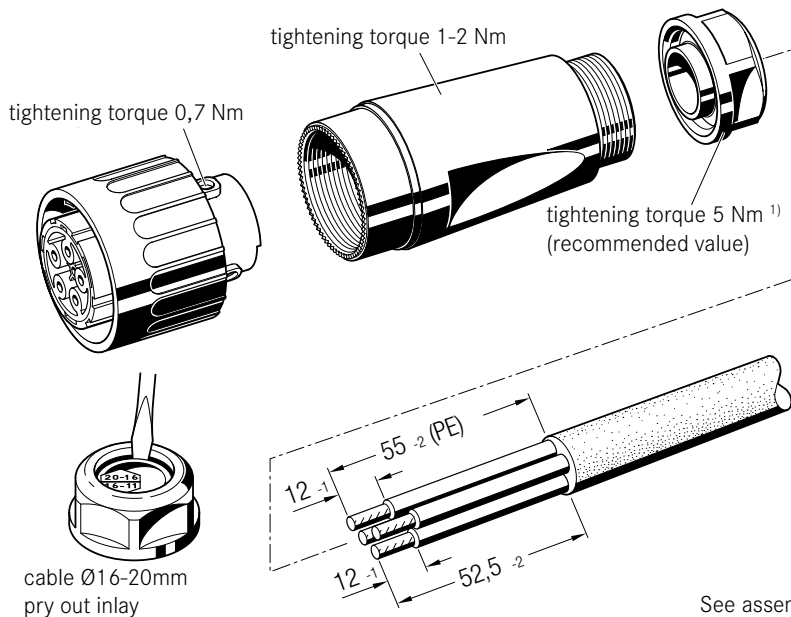

See assembling remarks on page 30.

<sup>1)</sup> The tightening torque are values that may vary depending on the cable.

<sup>2)</sup> End splice recommended

## Termination methods

### • Screw connection

Screw clamps are designed acc. to EN 60999-1 / VDE 609-1.

Chart 1 below shows the screw size depending on wire size and the required clamping and testing torque..

**Chart 1**

Wire size (mm <sup>2</sup> )	max.4
Screw size	M3
Test torque(Ncm)	50

Diagram 1 below shows the range of tensile strength for a screw connection with a clamp screw M3, fastened with a torque of 50 Ncm, depending on the wire size.

**Diagram 1**

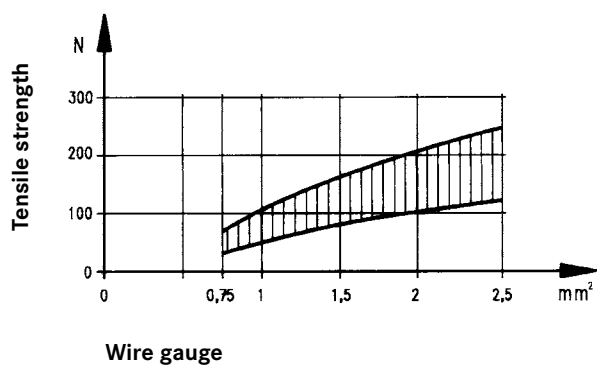

This comparison chart allows a cross reference between American Wire Gauge (AWG) and metric wire sizes (mm<sup>2</sup>).

**Chart 2**

AWG	Wire Composition	Wire diameter	Wire size
30	1 x 0.25	0.25 mm	0.05 mm <sup>2</sup>
	7 x 0.10	0.36 mm	0.06 mm <sup>2</sup>
28	1 x 0.32	0.32 mm	0.08 mm <sup>2</sup>
	7 x 0.13	0.38 mm	0.09 mm <sup>2</sup>
26	1 x 0.40	0.40 mm	0.13 mm <sup>2</sup>
	7 x 0.16	0.48 mm	0.14 mm <sup>2</sup>
	19 x 0.10	0.51 mm	0.15 mm <sup>2</sup>
24	1 x 0.51	0.51 mm	0.21 mm <sup>2</sup>
	7 x 0.20	0.61 mm	0.23 mm <sup>2</sup>
	19 x 0.13	0.64 mm	0.24 mm <sup>2</sup>
22	1 x 0.64	0.64 mm	0.33 mm <sup>2</sup>
	7 x 0.25	0.76 mm	0.36 mm <sup>2</sup>
	19 x 0.16	0.81 mm	0.38 mm <sup>2</sup>
20	1 x 0.81	0.81 mm	0.52 mm <sup>2</sup>
	7 x 0.32	0.97 mm	0.56 mm <sup>2</sup>
	19 x 0.20	1.02 mm	0.62 mm <sup>2</sup>
18	1 x 1.02	1.02 mm	0.79 mm <sup>2</sup>
	19 x 0.25	1.27 mm	0.96 mm <sup>2</sup>
16	19 x 0.29	1.44 mm	1.23 mm <sup>2</sup>
14	19 x 0.36	1.80 mm	1.95 mm <sup>2</sup>
12	19 x 0.46	2.29 mm	3.09 mm <sup>2</sup>
10	37 x 0.40	3.10 mm	4.60 mm <sup>2</sup>
8	133 x 0.29	4.0 mm	8.80 mm <sup>2</sup>
6	133 x 0.36	5.5 mm	13.5 mm <sup>2</sup>

It has to be noted that wires of the same AWG number but with different composition have slightly different mm<sup>2</sup>.

**Chart 3**

Composition and Dimensions of Copper Wires

Wire Size	Wire Composition	Wire diameter
0.09 mm <sup>2</sup>	12 x 0.10	0.48 mm
0.14 mm <sup>2</sup>	18 x 0.10	0.50 mm
0.25 mm <sup>2</sup>	14 x 0.15	0.70 mm
0.34 mm <sup>2</sup>	7 x 0.25	0.78 mm
0.5 mm <sup>2</sup>	16 x 0.20	1.0 mm
0.75 mm <sup>2</sup>	24 x 0.20	1.2 mm
1.0 mm <sup>2</sup>	32 x 0.20	1.4 mm
1.5 mm <sup>2</sup>	30 x 0.25	1.6 mm
2.5 mm <sup>2</sup>	35 x 0.30	2.2 mm
4.0 mm <sup>2</sup>	56 x 0.30	2.8 mm
6.0 mm <sup>2</sup>	19 x 0.64	3.4 mm
10 mm <sup>2</sup>	19 x 0.80	4.3 mm

## • Crimp connection

A crimp connection is a non-detachable electrical connection between a wire and a crimp contact produced with the crimp technology. Precise crimping dies which are matched to the crimp barrel and the wire size and a defined deformation result in a reliable electrical connection.

There are open crimp barrels (stamped contacts) and closed crimp barrels (turned contacts).

- Efficient termination of contacts.
- Reproducible termination achieve consistent electrical and mechanical results

The requirements for crimp connections are defined in DIN EN 60352-2, IEC 60352-2.

An important point of the quality of a crimp connection is the achieved tensile strength of the termination.

Easily measured, the tensile strength is a practicable means for quality control purposes.

Diagram 2 below shows the required minimum tensile strength for open and closed barrels depending on the wire size.

## Assembly instructions

For crimp contacts use the released crimp tool.

The insertion and extraction of crimp contacts shall only be approved with the corresponding insertion / extraction tool.

**A detailed description of the crimp technology can be found in our crimp tooling catalogues.**

**Crimp contacts are in this catalogues on page 23/24.**

Diagram 2

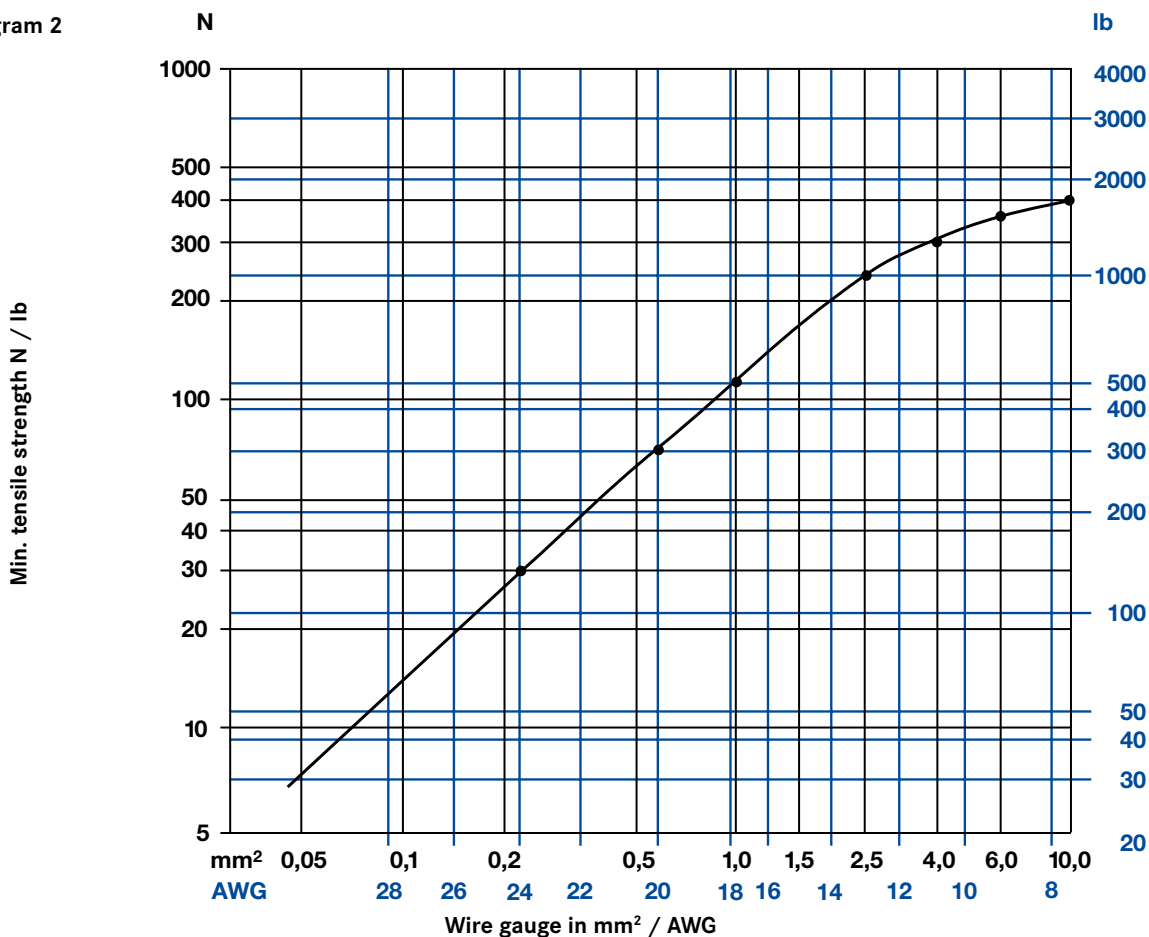

## Degree of protection

Electrical devices to which connectors belong to have to be protected for safety reasons from outside influences like dust, foreign objects, direct contact, moisture and water. This protection is provided on industrial connectors by its housings with their latching devices and sealed cable entries. The degree of protection can be selected depending on the type of intended use. The standard IEC 60529 and/or DIN EN 60529 has specified the degree of protection and divided into several classes.

The degree of protection is indicated in the following way:

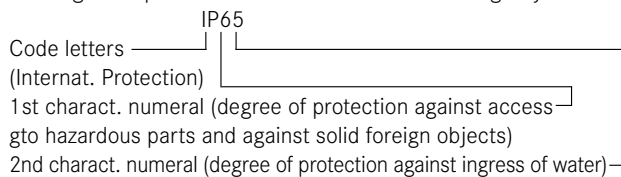

The following charts 4 and 5 give an overview about all protection degrees.

**Chart 4**

1st charact. numeral	Brief description	Definition
0	Non-protected	-
1	Protected against access to hazardous parts with the back of a hand. Protected against solid foreign objects of $\geq 50\text{mm } \varnothing$ .	The probe, sphere of $50\text{mm } \varnothing$ , shall not fully penetrate and shall have adequate clearance from hazardous parts.
2	Protected against access to hazardous parts with a finger. Protected against solid foreign objects of $\geq 12,5\text{mm } \varnothing$ .	The jointed test finger of $12\text{mm } \varnothing$ , $80\text{mm}$ length, shall have adequate clearance from hazardous parts. The probe, sphere of $12,5\text{mm } \varnothing$ , shall not fully penetrate.
3	Protected against access to hazardous parts with a tool. Protected against solid foreign objects of $\geq 2,5\text{mm } \varnothing$ .	The probe of $2,5\text{mm } \varnothing$ shall not penetrate at all.
4	Protected against access to hazardous parts with a wire. Protected against solid foreign objects of $\geq 1\text{mm } \varnothing$ .	The probe of $1\text{mm } \varnothing$ shall not penetrate at all.
5	Protected against access to hazardous parts with a wire. Dust-protected.	The probe of $1\text{mm } \varnothing$ shall not penetrate. Intrusion of dust is not totally prevented, but dust shall not penetrate in a quantity to interfere with satisfactory operation of the device or to impair safety.
6	Protected against access to hazardous parts with a wire. Dust-tight.	The probe of $1\text{mm } \varnothing$ shall not penetrate. No intrusion of dust.

**Chart 5**

2nd charact. numeral	Brief description	Definition
0	Non-protected	-
1	Protected against vertically falling water drops	Vertically falling drops shall have no harmful effects.
2	Protected against vertically falling water drops when enclosure tilted up to $15^\circ$	Vertically falling drops shall have no harmful effects when the enclosure is tilted at any angle up to $15^\circ$ on either side of the vertical.
3	Protected against spraying water	Water sprayed at an angle up to $60^\circ$ on either side of the vertical shall have no harmful effects.
4	Protected against splashing water	Water splashed against the enclosure from any direction shall have no harmful effects.
5	Protected against water jets	Water projected in jets against the enclosure from any direction shall have no harmful effects.
6	Protected against powerful water jets	Water projected in powerful jets against the enclosure from any direction shall have no harmful effects.
7	Protected against the effects of temporary immersion in water	Intrusion of water in quantities causing harmful effects shall not be possible when the enclosure is temporarily immersed in water for 30 min. in $1\text{m}$ depth.
8	Protected against the effects of continuous immersion in water	Intrusion of water in quantities causing harmful effects shall not be possible when the enclosure is continuously immersed in water under conditions which shall be agreed between manufacturer and user but which are more severe than for numeral 7.
9K <sup>1)</sup>	Protected against water during high pressure/ steam jet cleaning	Water projected in powerful jets with high pressure against the enclosure from any direction shall have no harmful effects.



### 1. General Remarks

These connectors are designed and produced in conformity with the low voltage directive (73/23/EWG) respectively Gerätesicherheitsgesetz (German law) and are especially in accordance with the standards DIN EN 61984 / IEC 61984 (VDE 0627); IEC 60664-1 (VSE 0110-1) and IEC 60529. The connectors may be used only within the technical ratings. These connectors with / without breaking capacity are designed and produced according to DIN EN 61984/VDE0627.

All technical data refers to mated connectors under live conditions. The safety of the connector system depends on the correct selection of products, proper assembly of the connector device, and a precise fit of the connectors.

### 2. Application Remarks

Connectors with / without breaking capacity must be used according to specified technical ratings.

The technical data represents the initial value of mated parts under predetermined conditions and length of time. These values could change with different test parameters or product requirements.

The 16-3 Series connectors are used in a wide variety of industries and equipment. Some of these include industrial machines and controls, data processing, instrumentation and test equipment, medical devices, telecommunication's network and equipment, plus outdoor and marine applications.

All rated data for the connectors listed in this catalogues are based on over-voltage category III 1) and pollution degree 3 2) for electronic applications.

Connectors were completely mated according to their respective safety locking mechanism. Selection and testing of connectors with / without breaking capacity to meet specific product or industrial requirements such as rated voltage and the related clearances and creepage distances are the responsibility of the user.

### 3. Assembling Remarks

Protection against electrical shock of the termination of the connectors shall be secured by correct mounting. Connectors of the same or different series being mounted side by side may be protected against incorrect mating by the use of coding options. Care must be taken to ensure the parts are correctly mated and screws are tightened with the proper torque.

### 4. Termination Remarks

Cable connectors are effectively secured when using the internal cable clamp. When the connector contains a simple gland bushing for retention without clamping ring the cable should have a strain relief close behind the connector. All cable properties or specifications must be compatible with the connector design and materials.

Designated wire conductors must be terminated to the correct poles in the connector.

Crimp contacts must be fully inserted into the plastic housing and retention assured with a slight tug on the wire.

Wire should be stripped correctly according to printed specifications to insure no electrical contact can be made between the conductors. There should be no nicked or cut strains during the stripping action.

- <sup>1)</sup> Overvoltage category III: Equipment intended for the use in installations or parts of it in which lightning overvoltages do not need to be considered, however switching overvoltages generated by the equipment, and for cases where the reliability and the availability of the equipment or its dependent circuits are subject to special requirements. Examples are protecting means, switches and sockets.
- <sup>2)</sup> Pollution degree 3: Conductive pollution occurs or dry non-conductive pollution occurs which becomes conductive due to condensation which is to be expected.

## Summary of Part Numbers

Part Number	Page	Part Number	Page	Part Number	Page	Part Number	Page
C016 00U000 001 1	17	C016 10H003 002 1	15	C016 20I005 105 2	18	TN 02 025 0010 (2)	24
C016 00U000 001 2	20	C016 10H003 003 1	15	C016 20K005 104 2	18	TN 02 025 0043 (1)	24
C016 00U000 011 2	20	C016 10H008 002 1	15	C016 20P004 800 2	22	VN 01 015 0046 (1)	23
C016 00U000 021 1	17	C016 10H008 003 1	15	C016 20P004 801 2	22	VN 01 015 0046 (2)	23
C016 00V000 001 1	17	C016 10H012 003 2	18	FH 0000-016	17	VN 01 015 0047 (1)	23
C016 00V000 001 2	20	C016 10H012 004 2	18	FH 0002-016	20	VN 01 015 0047 (2)	23
C016 00V000 011 2	20	C016 10H014 002 1	15	HN 01 015 0046 (1)	23	VN 01 015 0052 (1)	23
C016 00V000 021 1	17	C016 10H014 003 1	15	HN 01 015 0046 (2)	23	VN 01 015 0052 (2)	23
C016 10C003 000 1	17	C016 10H014 003 2	18	HN 01 015 0047 (1)	23	VN 01 016 0002 (1)	23
C016 10C008 000 1	17	C016 10H014 004 2	18	HN 01 015 0047 (2)	23	VN 01 016 0002 (2)	23
C016 10C012 000 2	19	C016 10H014 005 2	18	HN 01 015 0052 (1)	23	VN 01 016 0003 (1)	23
C016 10C014 000 1	17	C016 10H015 002 1	15	HN 01 015 0052 (2)	23	VN 01 016 0003 (2)	23
C016 10C014 000 2	19	C016 10H015 003 1	15	HN 01 016 0002 (1)	23	VN 01 016 0005 (1)	23
C016 10C015 000 1	17	C016 10H017 002 1	15	HN 01 016 0002 (2)	23	VN 01 016 0005 (2)	23
C016 10C017 000 1	17	C016 10H017 003 1	15	HN 01 016 0003 (1)	23	VN 01 025 0001 (101)	23
C016 10C019 000 2	19	C016 10H019 003 2	18	HN 01 016 0003 (2)	23	VN 01 025 0001 (102)	23
C016 10D003 002 1	16	C016 10H019 004 2	18	HN 01 016 0005 (1)	23	VN 01 025 0010 (101)	23
C016 10D 003 003 1	16	C016 10I003 002 1	15	HN 01 016 0005 (2)	23	VN 01 025 0010 (102)	23
C016 10D008 002 1	16	C016 10I003 003 1	15	HN 01 025 0001 (1)	23	VN 01 025 0043(1)	23
C016 10D008 003 1	16	C016 10I008 002 1	15	HN 01 025 0001 (2)	23	VN 02 015 0046 (1)	24
C016 10D012 003 2	19	C016 10I008 003 1	15	HN 01 025 0010 (1)	23	VN 02 015 0046 (2)	24
C016 10D012 004 2	19	C016 10I012 003 2	18	HN 01 025 0010 (2)	23	VN 02 015 0047 (1)	24
C016 10D014 002 1	16	C016 10I012 004 2	18	HN 01 025 0043 (1)	23	VN 02 015 0047 (2)	24
C016 10D014 003 1	16	C016 10I012 005 2	18	HN 02 015 0046 (1)	24	VN 02 015 0052 (1)	24
C016 10D014 003 2	19	C016 10I014 002 1	15	HN 02 015 0046 (2)	24	VN 02 015 0052 (2)	24
C016 10D014 004 2	19	C016 10I014 003 1	15	HN 02 015 0047 (1)	24	VN 02 016 0002 (1)	24
C016 10D015 002 1	16	C016 10I014 003 2	18	HN 02 015 0047 (2)	24	VN 02 016 0002 (2)	24
C016 10D015 003 1	16	C016 10I014 004 2	18	HN 02 015 0052 (1)	24	VN 02 016 0003 (1)	24
C016 10D017 002 1	16	C016 10I014 005 2	18	HN 02 015 0052 (2)	24	VN 02 016 0003 (2)	24
C016 10D017 003 1	16	C016 10I015 002	15	HN 02 016 0002 (1)	24	VN 02 016 0005 (1)	24
C016 10D019 003 2	19	C016 10I015 003 1	15	HN 02 016 0002 (2)	24	VN 02 016 0005 (2)	24
C016 10D019 004 2	19	C016 10I017 002 1	15	HN 02 016 0003 (1)	24	VN 02 025 0001 (101)	24
C016 10E003 002 1	16	C016 10I017 003 1	15	HN 02 016 0003 (2)	24	VN 02 025 0001 (102)	24
C016 10E 003 003 1	16	C016 10I019 003 2	18	HN 02 016 0005 (1)	24	VN 02 025 0010 (101)	24
C016 10E008 002 1	16	C016 10I019 004 2	18	HN 02 016 0005 (2)	24	VN 02 025 0010 (102)	24
C016 10E008 003 1	16	C016 10I019 005 2	18	HN 02 025 0001 (1)	24	VN 02 025 0043 (1)	24
C016 10E012 003 2	19	C016 10K003 002 1	15	HN 02 025 0001 (2)	24	ZN 01 015 0046 (1)	23
C016 10E012 004 2	19	C016 10K003 003 1	15	HN 02 025 0010 (1)	24	ZN 01 015 0046 (2)	23
C016 10E012 005 2	19	C016 10K008 002 1	15	HN 02 025 0010 (2)	24	ZN 01 015 0047 (1)	23
C016 10E014 002 1	16	C016 10K008 003 1	15	HN 02 025 0043(1)	24	ZN 01 015 0047 (2)	23
C016 10E014 003 1	16	C016 10K012 004 2	18	TN 01 015 0046 (1)	23	ZN 01 015 0052 (1)	23
C016 10E014 003 2	19	C016 10K014 002 1	15	TN 01 015 0046 (2)	23	ZN 01 015 0052 (2)	23
C016 10E014 004 2	19	C016 10K014 003 1	15	TN 01 015 0047 (1)	23	ZN 01 016 0002 (1)	23
C016 10E014 005 2	19	C016 10K014 004 2	18	TN 01 015 0047 (2)	23	ZN 01 016 0002 (2)	23
C016 10E015 002 1	16	C016 10K015 002 1	15	TN 01 015 0052 (1)	23	ZN 01 016 0003 (1)	23
C016 10E015 003 1	16	C016 10K015 003 1	15	TN 01 015 0052 (2)	23	ZN 01 016 0003 (2)	23
C016 10E017 002 1	16	C016 10K017 002 1	15	TN 01 016 0002 (1)	23	ZN 01 016 0005 (1)	23
C016 10E017 003 1	16	C016 10K017 003 1	15	TN 01 016 0002 (2)	23	ZN 01 016 0005 (2)	23
C016 10E019 003 2	19	C016 10K019 004 2	18	TN 01 016 0003 (1)	23	ZN 01 025 0001 (1)	23
C016 10E019 004 2	19	C016 10N003 006 1	16	TN 01 016 0003 (2)	23	ZN 01 025 0001 (2)	23
C016 10E019 005 2	19	C016 10N008 006 1	16	TN 01 016 0005 (1)	23	ZN 01 025 0010 (1)	23
C016 10F003 002 1	16	C016 10N014 006 1	16	TN 01 016 0005 (2)	23	ZN 01 025 0010 (2)	23
C016 10F003 003 1	16	C016 10N015 006 1	16	TN 01 025 0001 (1)	23	ZN 01 025 0043 (1)	23
C016 10F008 002 1	16	C016 10N017 006 1	16	TN 01 025 0001 (2)	23	ZN 02 015 0046 (1)	24
C016 10F008 003 1	16	C016 10P002 800 1	21	TN 01 025 0010 (1)	23	ZN 02 015 0046 (2)	24
C016 10F012 004 2	19	C016 20C005 100 2	19	TN 01 025 0010 (2)	23	ZN 02 015 0047 (1)	24
C016 10F014 002 1	16	C016 20D005 103 2	19	TN 01 025 0043 (1)	23	ZN 02 015 0047 (2)	24
C016 10F014 003 1	16	C016 20D005 104 2	19	TN 02 015 0046 (1)	24	ZN 02 015 0052 (1)	24
C016 10F014 004 2	19	C016 20E002 800 1	21	TN 02 015 0046 (2)	24	ZN 02 015 0052 (2)	24
C016 10F015 002 1	16	C016 20E002 801 1	21	TN 02 015 0047 (1)	24	ZN 02 016 0002 (1)	24
C016 10F015 003 1	16	C016 20E002 802 1	21	TN 02 015 0047 (2)	24	ZN 02 016 0002 (2)	24
C016 10F017 002 1	16	C016 20E004 800 2	22	TN 02 015 0052 (1)	24	ZN 02 016 0003 (1)	24
C016 10F017 003 1	16	C016 20E004 801 2	22	TN 02 015 0052 (2)	24	ZN 02 016 0003 (2)	24
C016 10F019 004 2	19	C016 20E005 103 2	19	TN 02 016 0002 (1)	24	ZN 02 016 0005 (1)	24
C016 10G003 000 1	16	C016 20E005 104 2	19	TN 02 016 0002 (2)	24	ZN 02 016 0005 (2)	24
C016 10G008 000 1	16	C016 20E005 105 2	19	TN 02 016 0003 (1)	24	ZN 02 025 0001 (1)	24
C016 10G012 000 2	18	C016 20F005 104 2	19	TN 02 016 0003 (2)	24	ZN 02 025 0001 (2)	24
C016 10G014 000 1	16	C016 20G005 100 2	18	TN 02 016 0005 (1)	24	ZN 02 025 0010 (1)	24
C016 10G014 000 2	18	C016 20H005 103 2	18	TN 02 016 0005 (2)	24	ZN 02 025 0010 (2)	24
C016 10G015 000 1	16	C016 20H005 104 2	18	TN 02 025 0001 (1)	24	ZN 02 025 0043 (1)	24
C016 10G017 000 1	16	C016 20I005 103 2	18	TN 02 025 0001 (2)	24		
C016 10G019 000 2	18	C016 20I005 104 2	18	TN 02 025 0010 (1)	24		

## International

### Argentina

Amphenol Argentina  
Av. Callao 930  
2nd Floor Office B "Plaza"  
C1023 AAP Buenos Aires  
Phone +54 11 4815 68 86  
www.amphenol.com.ar

### Australia

Amphenol Australia Pty. Ltd.  
2 Fiveways Blvd  
Keysborough  
Victoria 31 73  
Phone +61 3 8796 88 88  
www.amphenol.com.au

### Brazil

Amphenol do Brasil Ltda.  
Rua Diogo Moreira 132, 20th Floor  
CEP 05423-101 Sao Paulo SP  
Phone +55 11 3815 10 03  
www.amphenol.com.br

### China

Amphenol-Tuchel Electronics  
China Branch  
20 Tianshan Road  
Changzhou 213022  
Phone +86 519 85 11 03 01  
www.amphenol.info

### France

Amphenol Socapex S.A.S.  
948, Promenade de l'Arve, BP 29  
Thyez Cedex, 74311  
Phone +33 4 5089 28 00  
www.amphenol-socapex.com

### Germany

Amphenol-Tuchel Electronics GmbH  
August-Haeusser-Str. 10  
74080 Heilbronn  
Phone +49 7131 929 0  
www.amphenol.de

### India

Amphenol Interconnect India Pvt Ltd  
105, Bhosari Industrial Area  
Pune - 411 026  
Phone +91 20 2712 04 81  
www.amphenol-in.com

### Italy

Amphenol-Tuchel Italy  
Via Barbaiana n. 5  
20020 Lainate (MI)  
Phone +39 02 9325 41  
www.amphenol.info

### Korea

Amphenol DaeShin Elect and  
Precision Co.,Ltd  
558 Songnae-Dong, Sosa-Gu  
Bucheon-City, Kyunggi-Do  
Korea 422-130  
Phone +82 32 6103 800  
www.amphenol.co.kr

### Mexico

Amphenol Mexico  
Prolongacion Reforma 61 - 6 B2  
Col. Paseo de las Lomas  
C.P. 01330 Mexico D.F.  
Phone +52 55 5258 99 84  
www.amphenolmexico.com

### Singapore

Asia Pacific Sales Operations  
72 Bendemeer Rd, No.03-32/33  
Hiap Huat House, Luzerne, 339941  
Singapore  
Phone +65 6294 2128  
www.amphenol.com

### South Africa

Amphenol International Ltd  
Chislehurst  
30 Impala Road  
2196 Chislehurst  
Sandton, 2146  
Phone +27 11 7839 517  
www.amphenol.co.za

### Spain

Amphenol Espana  
Edificio Burgosal, Oficina 55  
C/Comunidad de Madrid, 35 bis  
Las Rozas (Madrid), 28230  
Phone +34 91 6407 302  
www.amphenol.com

### Taiwan

Amphenol East Asia Limited-Taiwan  
5F, No. 361, Fusing 1st Rd  
Gueishan Township,  
Taoyuan County 333  
Phone +886 3 2647 200  
www.amphenol.com

Amphenol LTW Technology Co., Ltd.  
9F, No. 657-12, Zhongzheng Road  
Xinzhuang Dist., New Taipei City  
242 Taiwan  
Phone +886 2 2908 5626  
sales@ltw-tech.com  
www.amphenolltw.com

### Turkey

Amphenol Turkey  
Sun Plaza Kat: 15  
Maslak Mah. Bilim Sok.No:15  
34398 Sisli - Istanbul  
Phone: +90 2123 679 220  
www.amphenol.com.tr

### United Kingdom

Amphenol Limited  
Thanet Way, Whitstable  
Kent, CT53JF  
Phone +44 1227 773 200  
www.amphenol.co.uk

### USA

Amphenol-Tuchel Electronics /  
Amphenol Sine Systems  
44724 Morley Drive  
48036 Clinton Township, MI  
Phone +1 586 913 8630  
www.amphenol.info

Amphenol Corporation  
Corporate Headquarters  
358 Hall Avenue  
Wallingford, CT 06492  
Phone +1 877 2674 366  
Phone +1 203 2658 900  
www.amphenol.com

More Amphenol companies can be  
found here: [www.amphenol.com](http://www.amphenol.com)



### Important Notice

All technical data have been measured in a laboratory environment and can be different during practical usage of the product. Any product information is for descriptive usage only and not legally binding; particularly the information does not constitute or provide any legal guaranties ("Beschaffensgarantie" or "Haltbarkeitsgarantie").

We reserve the right to change the design due to improvement in quality, development or production requirements. This catalogue must not be used in any form or manner without our prior approval in writing (Copyright Law, Fair Trading Law, Civil Code).

Your engineering sales representative: