

## Description

The F2270 is a 75Ω, low insertion loss voltage variable RF attenuator (VVA) designed for a multitude of wireless and other RF applications. This device covers a broad frequency range from 5MHz to 3000MHz. In addition to providing low insertion loss, the F2270 provides excellent linearity performance over its entire attenuation range.

The F2270 uses a positive supply voltage of 3.3V or 5V. Other features include a  $V_{MODE}$  pin allowing either a positive or negative voltage control slope versus attenuation and multi-directional operation where the RF input can be applied to either the RF1 or RF2 pins. The attenuation control voltage range is from 0V to 5V using either a 3.3V or 5V power supply.

## Competitive Advantage

The F2270 provides extremely low insertion loss and superb IP3, IP2, return loss performance, and slope linearity across the control range. Compared to the previous state-of-the-art for silicon VVAs, this device provides superior performance:

- Operation down to 5MHz
- Insertion loss at 300MHz of 1.1dB
- Typical attenuation slope: 10dB/Volt
- Minimum OIP3 (maximum attenuation): +35dBm
- Minimum IIP2 (maximum attenuation, > 35MHz): +85dBm

## Typical Applications

- CATV/Broadband Applications
  - Headend
  - Fiber/HFC Distribution Nodes
- CATV Test Equipment

## Features

- Frequency range: 5MHz to 3000MHz
- Low insertion loss: 1.1dB at 300MHz
- Typical/Minimum IIP3  $\geq$  50MHz: 62dBm / 46dBm
- Typical/Minimum IIP2  $\geq$  50MHz: 98dBm / 77dBm
- Up to 35dB attenuation range
- Attenuation slope versus  $V_{CTRL}$ : 10dB/Volt
- Bi-directional RF ports
- +36dBm input P1dB
- $V_{MODE}$  pin allows either positive or negative attenuation control response
- Linear-in-dB attenuation characteristic
- Nominal supply voltage: 3.3V or 5V
- $V_{CTRL}$  range: 0V to 5V using 3.3V or 5V supply
- -40°C to +105°C operating temperature range
- 3 × 3 mm, 16-VFQFPN package

## Block Diagram

Figure 1. Block Diagram

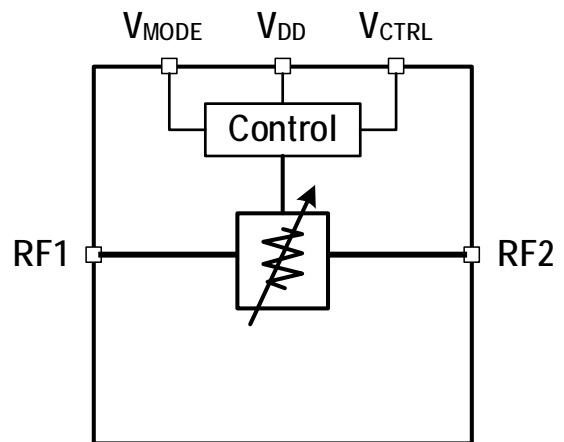

## Pin Assignments

Figure 2. Pin Assignments for 3 x 3 x 0.9 mm 16-VFQFPN Package – Top View

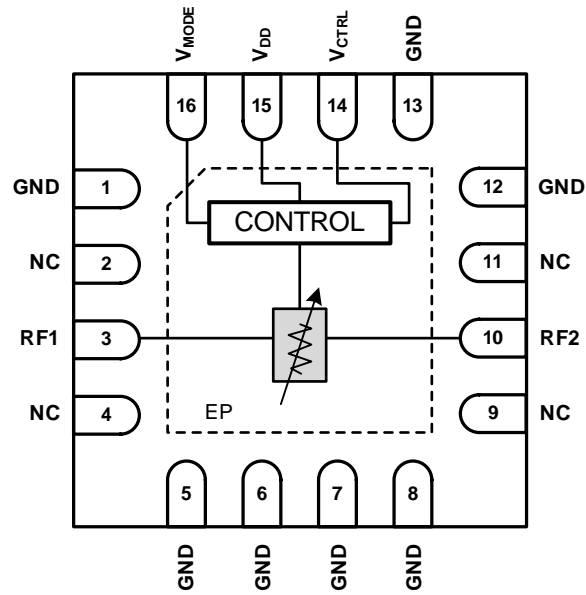

## Pin Descriptions

Table 1. Pin Descriptions

Number	Name	Description
1, 5 – 8, 12, 13	GND	Internally grounded. This pin must be grounded as close to the device as possible.
2, 4, 9, 11	NC	No internal connection. These pins can be left unconnected, have a voltage applied, or be connected to ground (recommended).
3	RF1	RF Port 1. Matched to 75Ω. Since the RF pin internally has DC present, an external AC coupling capacitor <b>must</b> be used. For low-frequency operation, increase the capacitor value to result in a low reactance at the frequency of interest. An external series inductor of 2.4nH can also be used to improve the high frequency match. This inductor, if used, should be placed as close to the device as possible.
10	RF2	RF Port 2. Matched to 75Ω. Since the RF pin internally has DC present, an external AC coupling capacitor <b>must</b> be used. For low-frequency operation, increase the capacitor value to result in a low reactance at the frequency of interest. An external series inductor of 2.8nH can also be used to improve the high frequency match. This inductor, if used, should be placed as close to the device as possible.
14	V <sub>CTRL</sub>	Attenuator control voltage. Apply a voltage in the range specified in under “Recommended Operating Conditions.” See the “Application Information” section for details about V <sub>CTRL</sub> . This pin is connected to an internal 100kΩ series resistor that drives a biased voltage divider network.
15	V <sub>DD</sub>	Power supply input. Bypass to ground (GND) with capacitors as close as possible to the pin.
16	V <sub>MODE</sub>	Attenuator slope control. Set to logic LOW to enable negative attenuation slope (maximum attenuation at maximum V <sub>CTRL</sub> ). Set to logic HIGH to enable positive attenuation slope (maximum attenuation at minimum V <sub>CTRL</sub> ). This pin is internally connected to a 170kΩ pull-down resistor to ground.
	– EPAD	Exposed paddle. Internally connected to ground. Solder this exposed paddle to a printed circuit board (PCB) pad that uses multiple ground vias to provide heat transfer out of the device into the PCB ground planes. These multiple ground vias are also required to achieve the specified RF performance.

## Absolute Maximum Ratings

Stresses above those listed below may cause permanent damage to the device. Functional operation of the device at these or any other conditions above those indicated in the operational section of this specification is not implied. Exposure to absolute maximum rating conditions for extended periods may affect device reliability.

Table 2. Absolute Maximum Ratings

Parameter	Symbol	Minimum	Maximum	Units
$V_{DD}$ to GND	$V_{DD}$	-0.3	6.0	V
$V_{MODE}$ to GND	$V_{MODE}$	-0.3	Lower of ( $V_{DD}$ , 3.9)	V
$V_{CTRL}$ to GND	$V_{CTRL}$	-0.3	Lower of ( $V_{DD} + 3.0$ , 5.3)	V
RF1, RF2 to GND	$V_{RF}$	-0.3	0.3	V
RF1 or RF2 Input Power Applied for 24 Hours Maximum ( $V_{DD}$ applied at 1GHz and $T_{EP}$ [Exposed Paddle] = +85°C, $Z_S = Z_L = 75\Omega$ )	$P_{MAX24}$		+28	dBm
Junction Temperature	$T_{JMAX}$		+150	°C
Storage Temperature Range	$T_{STOR}$	-65	+150	°C
Lead Temperature (soldering, 10s)	$T_{LEAD}$		+260	°C
Electrostatic Discharge – HBM (JEDEC/ESDA JS-001-2012)	$V_{ESDHMB}$		2000 (Class 2)	V
Electrostatic Discharge – CDM (JEDEC 22-C101F)	$V_{ESDHCDM}$		500 (Class C2)	V

## Recommended Operating Conditions

Table 3. Recommended Operating Conditions

Parameter	Symbol	Condition	Minimum	Typical	Maximum	Units
Power Supply Voltage	$V_{DD}$		3.15		5.5	V
Mode Voltage [a]	$V_{MODE}$		0		Lower of ( $V_{DD}$ , 3.6)	V
Control Voltage [a]	$V_{CTRL}$		0		Lower of ( $V_{DD} + 3.0$ , 5.0)	V
Operating Temperature Range	$T_{EP}$	Exposed Paddle	-40		+105	°C
RF Frequency Range	$f_{RF}$		5		3000	MHz
Maximum Input RF Power	$P_{MAX}$	Power can be applied to RF1 or RF2			See Figure 3	dBm
RF1 Port Impedance	$Z_{RF1}$			75		$\Omega$
RF2 Port Impedance	$Z_{RF2}$			75		$\Omega$

[a] The power supply voltage must be applied before all other voltages.

Figure 3. Maximum Operating CW RF Input Power vs. Frequency ( $Z_s = Z_L = 75\Omega$ )

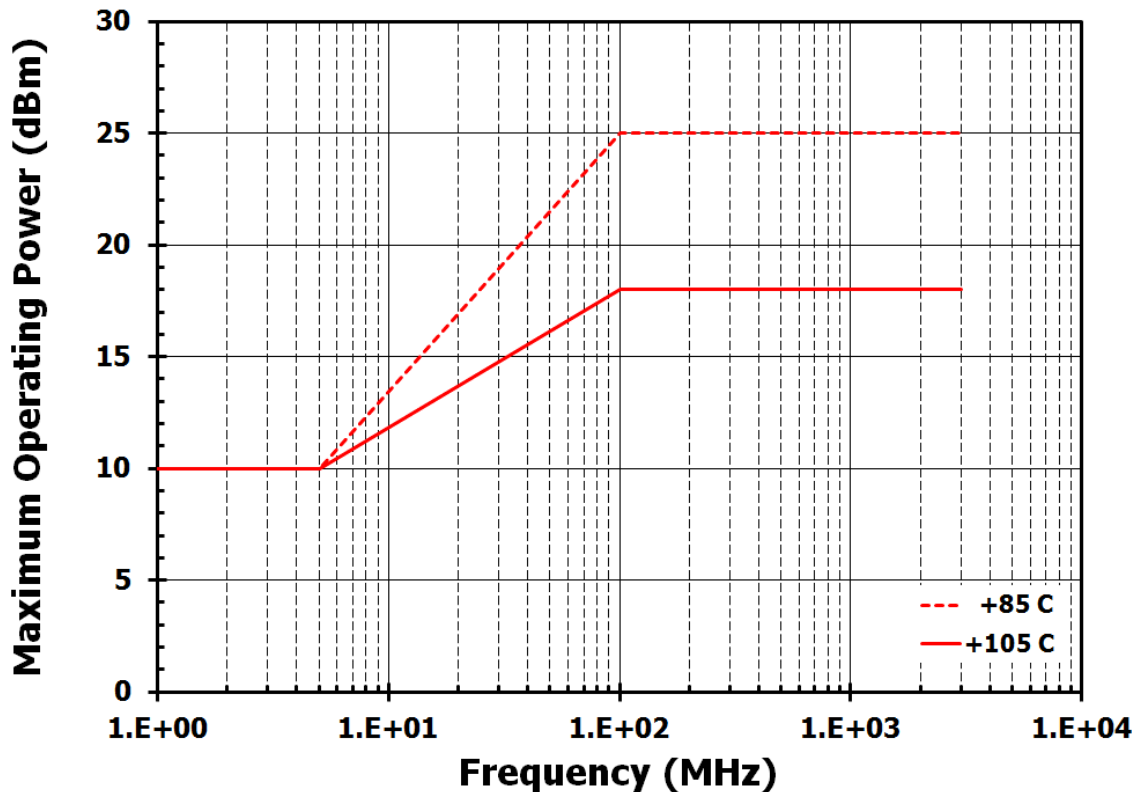

## Electrical Characteristics

Table 4. Electrical Characteristics (General)

Refer to the application circuit in Figure 60 for the required circuit and use  $L1 = L2 = 0\Omega$ . The specifications in this table apply at  $V_{DD} = +5.0V$ ,  $T_{EP} = +25^{\circ}C$ ,  $f_{RF} = 500MHz$ ,  $Z_S = Z_L = 75\Omega$ , signal applied to RF1, minimum attenuation,  $P_{IN} = 0dBm$  for small signal parameters,  $P_{IN} = +20dBm$  per tone for two tone tests,  $V_{MODE}$  is LOW or HIGH, and Evaluation Board (EVKit) trace and connector losses are de-embedded, unless otherwise noted.

Parameter	Symbol	Condition	Minimum	Typical	Maximum	Units
$V_{MODE}$ Logic Input HIGH	$V_{IH}$	$3.9V \leq V_{DD} \leq 5.5V$	<b>1.07</b> [a]		3.6	V
		$V_{DD} < 3.9V$	<b>1.07</b>		$V_{DD} - 0.3$	
$V_{MODE}$ Logic Input LOW	$V_{IL}$		0		<b>0.63</b>	V
$V_{DD}$ Current	$I_{DD}$			1.4	<b>2.5</b>	mA
$V_{MODE}$ Current	$I_{MODE}$			<b>25</b>		$\mu A$
$V_{CTRL}$ Current	$I_{CTRL}$			<b>50</b>		$\mu A$
Attenuation Slope	$ATT_{SLOPE}$	$V_{MODE} = LOW$		10		dB/V
		$V_{MODE} = HIGH$		-10		
Attenuation Variation over Temperature (reference to $+25^{\circ}C$ )	$ATT_{VAR}$	$f_{RF} = 50MHz$ ( $-40^{\circ}C$ to $105^{\circ}C$ , over full signal range of $V_{CTRL}$ )		$\pm 1$		dB
Settling Time	$t_{SETTLE}$	Any 1dB step in the 0dB to 33dB control range, 50% of $V_{CTRL}$ signal to RF settled to within $\pm 0.1dB$		25		$\mu s$

[a] Specifications in the minimum/maximum columns that are shown in **bold italics** are guaranteed by test. Specifications in these columns that are not shown in bold italics are guaranteed by design characterization.

## Electrical Characteristics (continued)

Table 5. Electrical Characteristics (No External RF Tuning)

Refer to the application circuit in Figure 60 for the required circuit and use  $L1 = L2 = 0\Omega$ . The specifications in this table apply at  $V_{DD} = +5.0V$ ,  $T_{EP} = +25^{\circ}C$ ,  $f_{RF} = 500MHz$ ,  $Z_S = Z_L = 75\Omega$ , signal applied to RF1, minimum attenuation,  $P_{IN} = 0dBm$  for small signal parameters,  $P_{IN} = +20dBm$  per tone for two tone tests,  $V_{MODE}$  is LOW or HIGH, and Evaluation Board (EVKit) trace and connector losses are de-embedded, unless otherwise noted.

Parameter	Symbol	Condition	Minimum	Typical	Maximum	Units
Insertion Loss, IL	$A_{MIN}$	Minimum attenuation		1.1	<b>1.8 [a]</b>	dB
Maximum Attenuation	$A_{MAX}$	$f_{RF} = 5MHz$		23		dB
		$f_{RF} = 10MHz$		28		
		$f_{RF} = 500MHz$	<b>33</b>	35		
		$300MHz < f_{RF} \leq 1800MHz$		35		
Attenuation Variation [c]	$A_{VAR}$	$V_{CTRL} = 1.0V, V_{MODE} = LOW$		$\pm 1.5$		dB
		$V_{CTRL} = 2.1V, V_{MODE} = LOW$		$\pm 2.8$		
Relative Insertion Phase	$\Phi_{\Delta MAX}$	At maximum attenuation relative to minimum attenuation		9		deg
RF1 Return Loss (over control voltage range)	$S_{11}$	$5MHz \leq f_{RF} \leq 300MHz$		23		dB
		$300MHz < f_{RF} \leq 1220MHz$		15		
		$1220MHz < f_{RF} \leq 1800MHz$		12		
RF2 Return Loss (over control voltage range)	$S_{22}$	$5MHz \leq f_{RF} \leq 300MHz$		23		dB
		$300MHz < f_{RF} \leq 1220MHz$		15		
		$1220MHz < f_{RF} \leq 1800MHz$		12		
Input Power Compression [b]	IP1dB			36		dBm
Input IP3	IIP3	$f_{RF} = 5MHz, 1MHz$ spacing		45		dBm
		$f_{RF} = 50MHz, 5MHz$ spacing		57		
		$300MHz < f_{RF} < 2GHz,$ 50MHz spacing		60		
Input IP3 over Attenuation	IIP3 <sub>ATTEN</sub>	All attenuation settings		46		dBm
Minimum Output IP3	OIP3 <sub>MIN</sub>	Maximum attenuation		35		dBm
Input IP2	IIP2	IM2 term is $f_1 + f_2$		98		dBm
Minimum Input IP2	IIP2 <sub>MIN</sub>	All attenuation settings		77		dBm
Input 2 <sup>nd</sup> Harmonic Intercept Point	IIP <sub>H2</sub>	$P_{IN} + H2_{dBc}$		82		dBm
Input 3 <sup>rd</sup> Harmonic Intercept Point	IIP <sub>H3</sub>	$P_{IN} + (H3_{dBc} / 2)$		50		dBm

[a] Specifications in the minimum/maximum columns that are shown in **bold italics** are guaranteed by test. Specifications in these columns that are not shown in bold italics are guaranteed by design characterization.

[b] The input 1dB compression point is a linearity figure of merit. Refer to the "Absolute Maximum Ratings" section for the maximum RF input power.

[c] This value is for part to part variation at the given voltage.

## Electrical Characteristics (continued)

Table 6. Electrical Characteristics – Extended Bandwidth Tuning (EBT) using external components  
Refer to the application circuit in Figure 60 for the required circuit and use  $L1 = 2.4\text{nH}$  and  $L2 = 2.8\text{nH}$ . The specifications in this table apply at  $V_{DD} = +5.0\text{V}$ ,  $T_{EP} = +25^\circ\text{C}$ ,  $f_{RF} = 500\text{MHz}$ ,  $Z_S = Z_L = 75\Omega$ , signal applied to RF1, minimum attenuation,  $P_{IN} = 0\text{dBm}$  for small signal parameters,  $P_{IN} = +20\text{dBm}$  per tone for two tone tests,  $V_{MODE}$  is LOW or HIGH, and Evaluation Board (EVKit) trace and connector losses are de-embedded, unless otherwise noted.

Parameter	Symbol	Condition	Minimum	Typical	Maximum	Units
Insertion Loss, IL	$A_{MIN}$	Minimum attenuation		1.1		dB
Maximum Attenuation	$A_{MAX}$	$f_{RF} = 5\text{MHz}$		23		dB
		$f_{RF} = 10\text{MHz}$		28		
		$50\text{MHz} < f_{RF} \leq 300\text{MHz}$		35		
		$300\text{MHz} < f_{RF} \leq 1800\text{MHz}$		35		
Attenuation Variation [c]	$A_{VAR}$	$V_{CTRL} = 1.0\text{V}$ , $V_{MODE} = \text{LOW}$		$\pm 1.5$		dB
		$V_{CTRL} = 2.1\text{V}$ , $V_{MODE} = \text{LOW}$		$\pm 2.8$		
Relative Insertion Phase	$\Phi_{\Delta MAX}$	At maximum attenuation relative to minimum attenuation		9		deg
RF1 Return Loss (over control voltage range)	$S_{11}$	$5\text{MHz} \leq f_{RF} \leq 300\text{MHz}$		23		dB
		$300\text{MHz} < f_{RF} \leq 1220\text{MHz}$		18		
		$1220\text{MHz} < f_{RF} \leq 1800\text{MHz}$		12		
RF2 Return Loss (over control voltage range)	$S_{22}$	$5\text{MHz} \leq f_{RF} \leq 300\text{MHz}$		23		dB
		$300\text{MHz} < f_{RF} \leq 1220\text{MHz}$		18		
		$1220\text{MHz} < f_{RF} \leq 1800\text{MHz}$		12		
Input Power Compression [b]	IP1dB			36		dBm
Input IP3 (Minimum Attenuation)	IIP3	$f_{RF} = 5\text{MHz}$ , 1MHz spacing		45		dBm
		$f_{RF} = 50\text{MHz}$ , 5MHz spacing		57		
		$300\text{MHz} < f_{RF} < 2\text{GHz}$ , 50MHz spacing		60		
Input IP3 over attenuation	IIP3 <sub>ATTEN</sub>	All attenuation settings		46		dBm
Minimum Output IP3	OIP3 <sub>MIN</sub>	Maximum attenuation		35		dBm
Input IP2	IIP2	IM2 term is $f_1 + f_2$		98		dBm
Minimum Input IP2	IIP2 <sub>MIN</sub>	All attenuation settings		77		dBm
Input 2 <sup>nd</sup> Harmonic Intercept Point	IIP <sub>H2</sub>	$P_{IN} + H2_{dBc}$		82		dBm
Input 3 <sup>rd</sup> Harmonic Intercept Point	IIP <sub>H3</sub>	$P_{IN} + (H3_{dBc} / 2)$		50		dBm

- [a] Specifications in the minimum/maximum columns that are shown in **bold italics** are guaranteed by test. Specifications in these columns that are not shown in bold italics are guaranteed by design characterization.
- [b] The input 1dB compression point is a linearity figure of merit. Refer to the “Absolute Maximum Ratings” section for the maximum RF input power.
- [c] This value is for part to part variation at the given voltage.



## Thermal Characteristics

Table 7. Package Thermal Characteristics

Parameter	Symbol	Value	Units
Junction to Ambient Thermal Resistance	$\theta_{JA}$	80.6	°C/W
Junction to Case Thermal Resistance (case is defined as the exposed paddle)	$\theta_{JC-BOT}$	5.1	°C/W
Moisture Sensitivity Rating (Per J-STD-020)		MSL 1	

## Typical Operating Conditions (TOCs)

Unless otherwise noted:

- $V_{DD} = +5.0V$
- $Z_S = Z_L = 75\Omega$
- $T_{EP} = +25^\circ C$
- RF trace and connector losses removed for insertion loss and attenuation results. All other results include the PCB trace and connector losses and mismatched effects.
- $P_{IN} = 0dBm$  for all small signal tests
  - $P_{IN} = +20dBm/$ tone for two tone linearity tests (RF1 port driven)
- Two tone frequency spacing
  - 1MHz for  $5MHz \leq f_{RF} < 50MHz$
  - 5MHz for  $50MHz \leq f_{RF} < 500MHz$
  - 50MHz for  $500MHz \leq f_{RF} < 3500MHz$
- All temperatures are referenced to the exposed paddle.
- Extended band tuning uses  $L1 = 2.4nH$  and  $L2 = 2.8nH$  to improve RF1 and RF2 port match.

Typical Performance Characteristics (No External RF Tuning)

Figure 4. Insertion Loss vs. Frequency  
[V<sub>MODE</sub> = LOW]

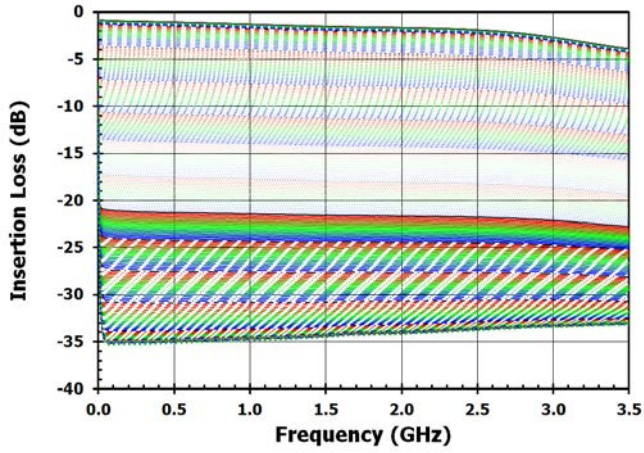

Figure 5. Relative Insertion Loss vs. V<sub>CTRL</sub>  
[V<sub>MODE</sub> = LOW]

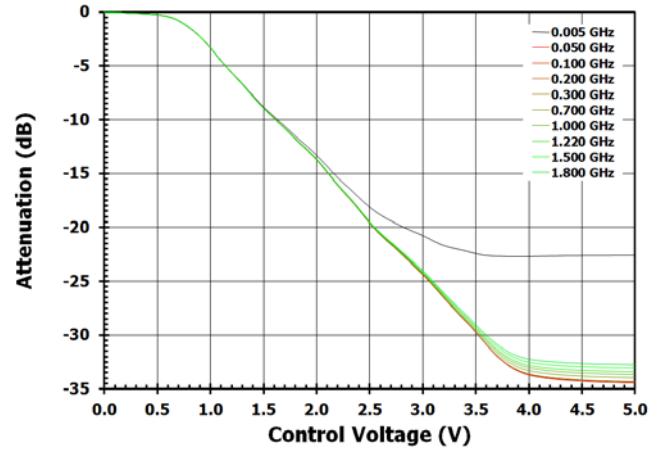

Figure 6. RF1 Return Loss vs. Frequency  
[V<sub>MODE</sub> = LOW]

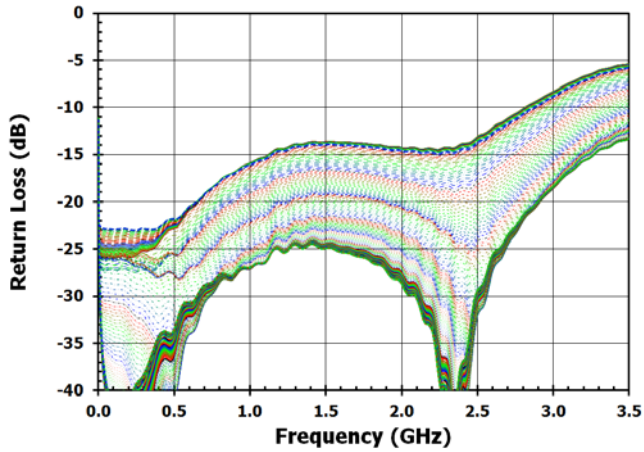

Figure 7. RF1 Return Loss vs. V<sub>CTRL</sub>  
[V<sub>MODE</sub> = LOW]

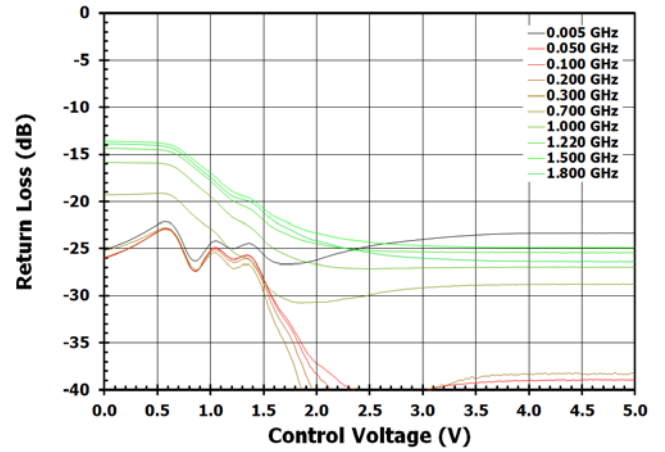

Figure 8. RF2 Return Loss vs. Frequency  
[V<sub>MODE</sub> = LOW]

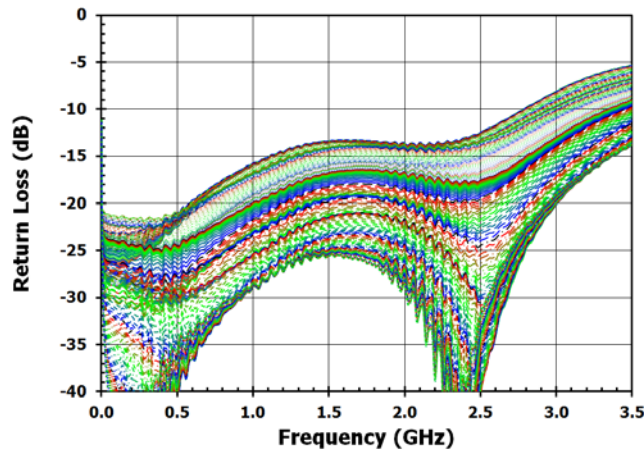
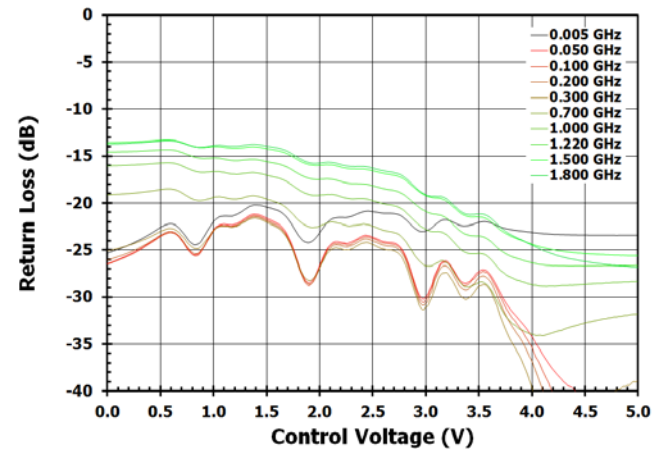

Figure 9. RF2 Return Loss vs. V<sub>CTRL</sub>  
[V<sub>MODE</sub> = LOW]



Typical Performance Characteristics (No External RF Tuning)

Figure 10. Relative Insertion Phase vs. Frequency [ $V_{MODE} = LOW$ ]

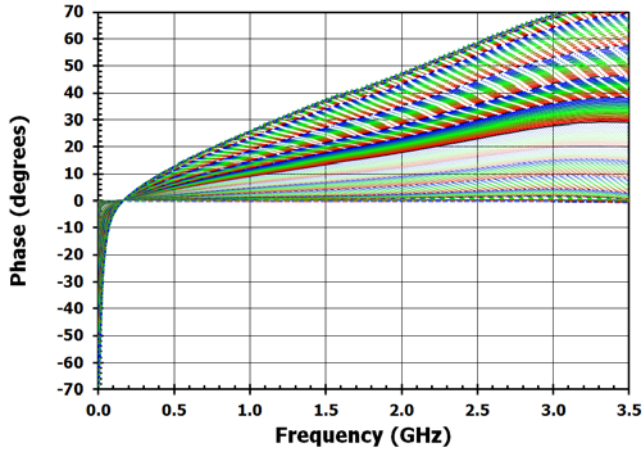

Figure 11. Relative Insertion Phase vs.  $V_{CTRL}$  [ $V_{MODE} = LOW$ ]

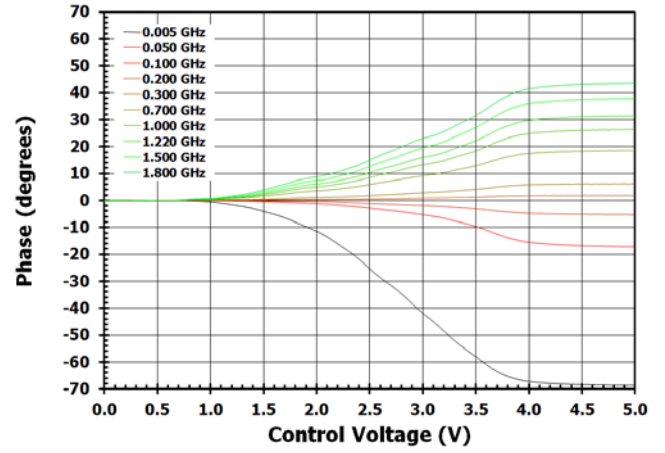

Figure 12. Insertion Loss vs. Frequency

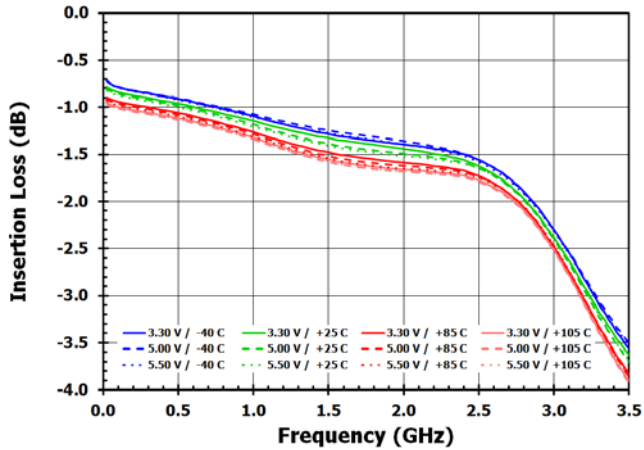
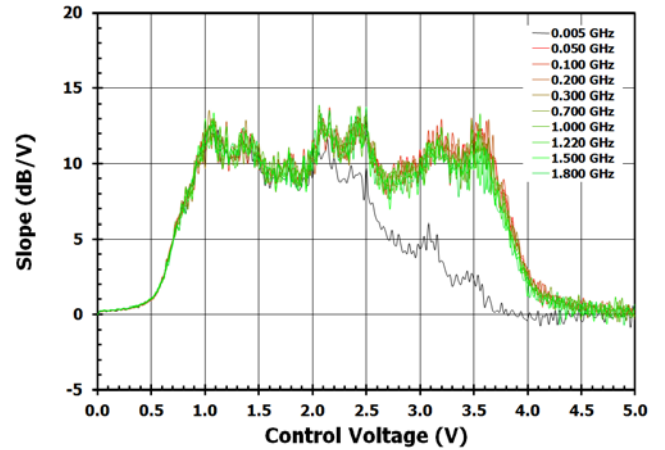

Figure 13. Attenuation Slope vs.  $V_{CTRL}$  [ $V_{MODE} = LOW$ ]



Typical Performance Characteristics (No External RF Tuning)

Figure 14. Insertion Loss vs. Frequency  
[V<sub>MODE</sub> = HIGH]

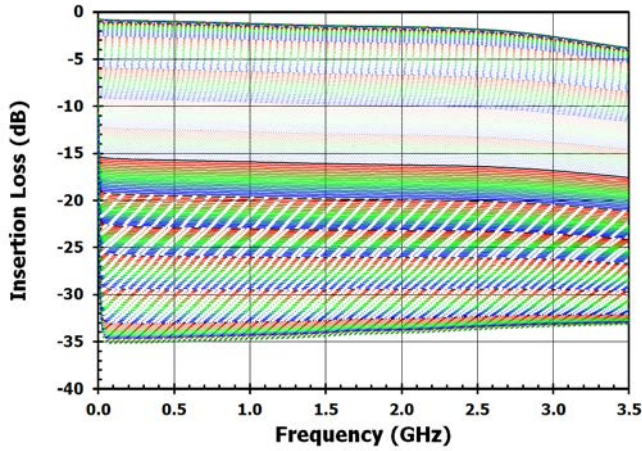

Figure 15. Relative Insertion Loss vs. V<sub>CTRL</sub>  
[V<sub>MODE</sub> = HIGH]

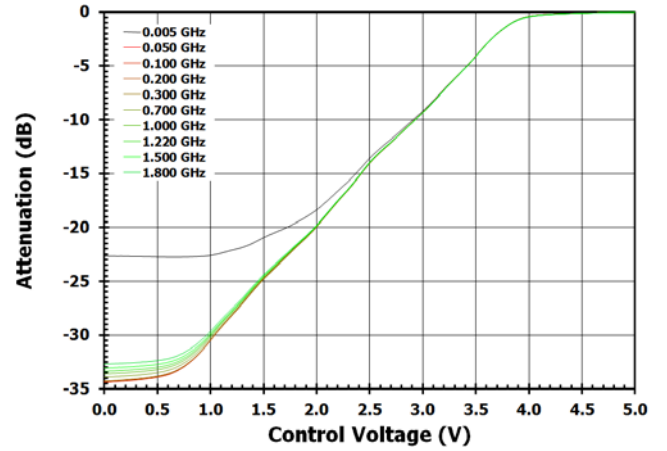

Figure 16. RF1 Return Loss vs. Frequency  
[V<sub>MODE</sub> = HIGH]

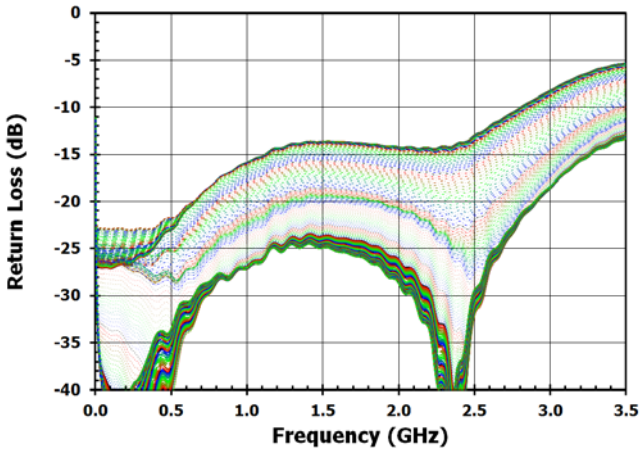

Figure 17. RF1 Return Loss vs. V<sub>CTRL</sub>  
[V<sub>MODE</sub> = HIGH]

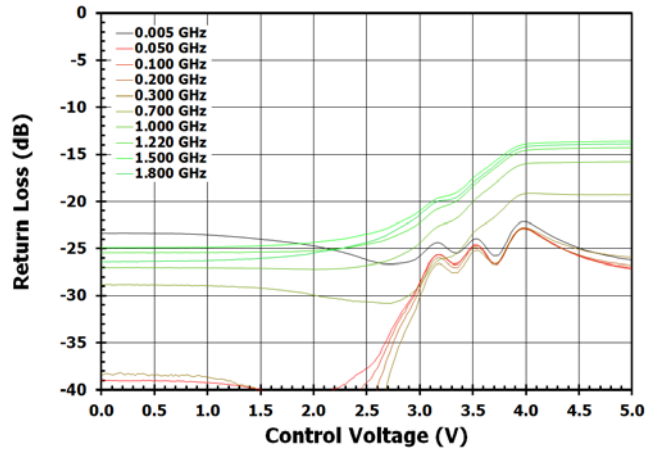

Figure 18. RF2 Return Loss vs. Frequency  
[V<sub>MODE</sub> = HIGH]

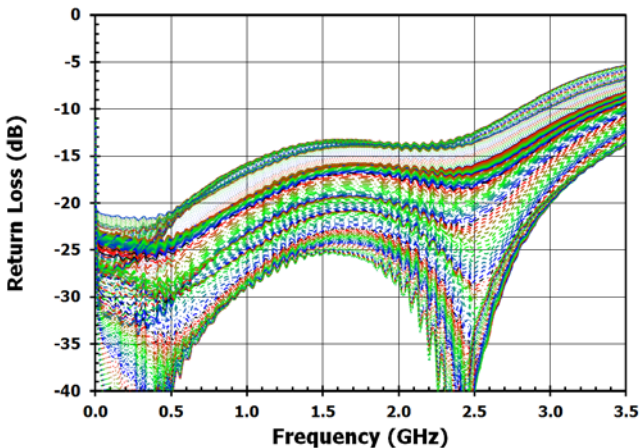
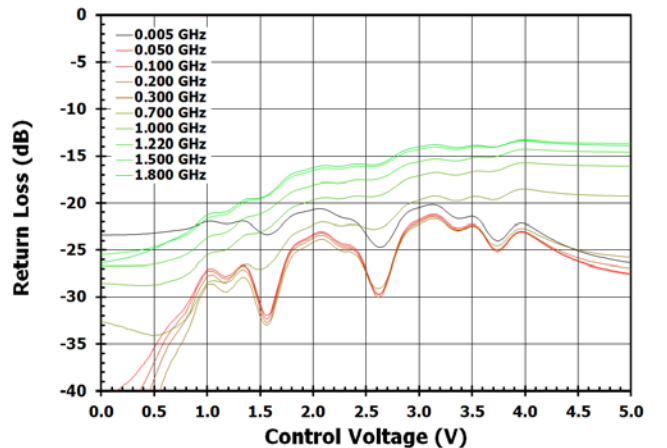

Figure 19. RF2 Return Loss vs. V<sub>CTRL</sub>  
[V<sub>MODE</sub> = HIGH]



Typical Performance Characteristics (No External RF Tuning)

Figure 20. Relative Insertion Phase vs. Frequency [ $V_{MODE} = HIGH$ ]

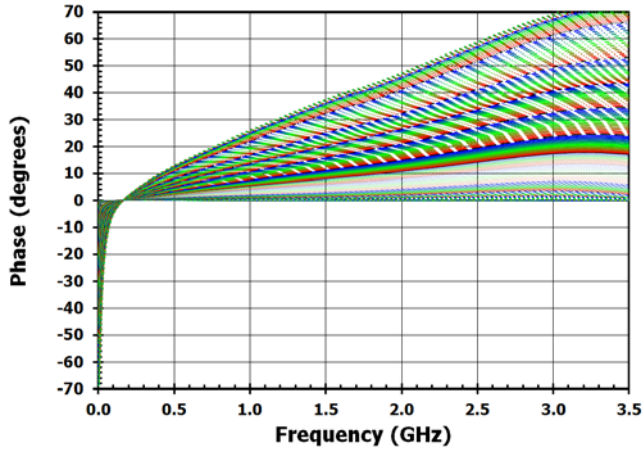

Figure 21. Relative Insertion Phase vs.  $V_{CTRL}$  [ $V_{MODE} = HIGH$ ]

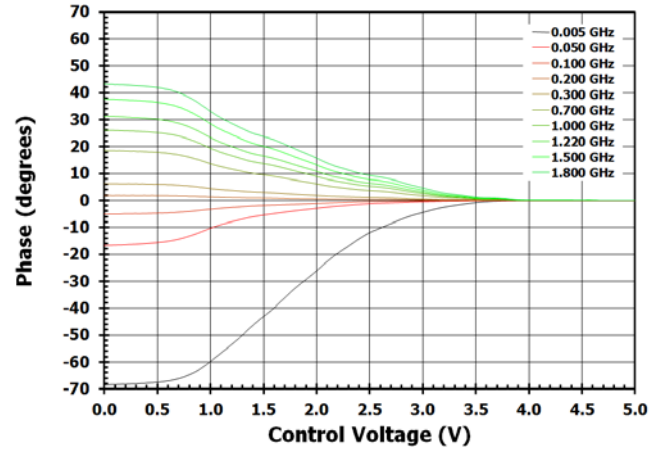
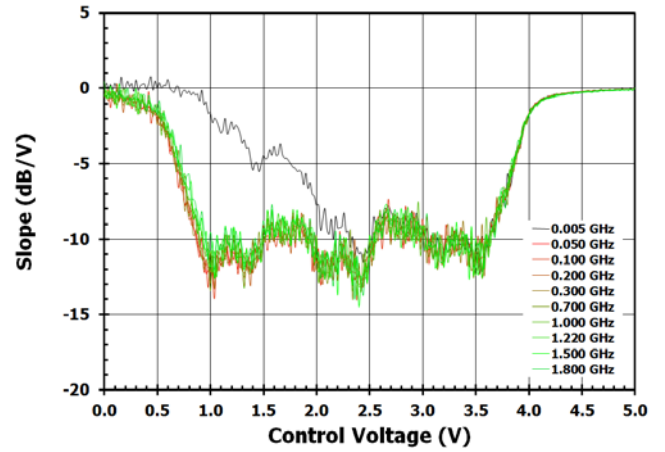

Figure 22. Attenuation Slope vs.  $V_{CTRL}$  [ $V_{MODE} = HIGH$ ]



Typical Performance Characteristics (No External RF Tuning)

Figure 23. Input IP3 vs.  $V_{CTRL}$   
[5MHz,  $V_{MODE} = LOW$ ]

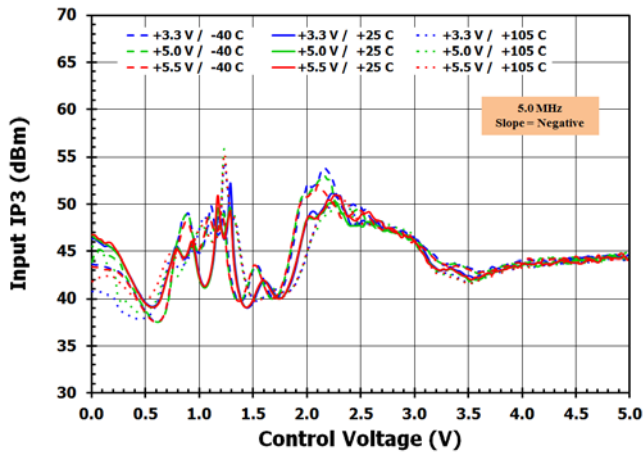

Figure 24. Input IP3 vs.  $V_{CTRL}$   
[5MHz,  $V_{MODE} = HIGH$ ]

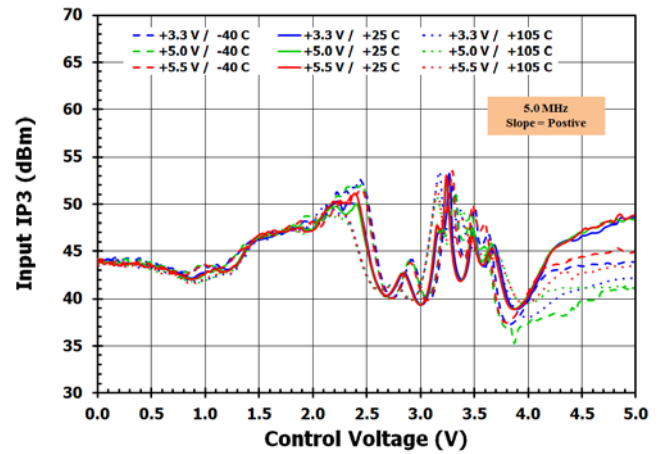

Figure 25. Input IP3 vs.  $V_{CTRL}$   
[50MHz,  $V_{MODE} = LOW$ ]

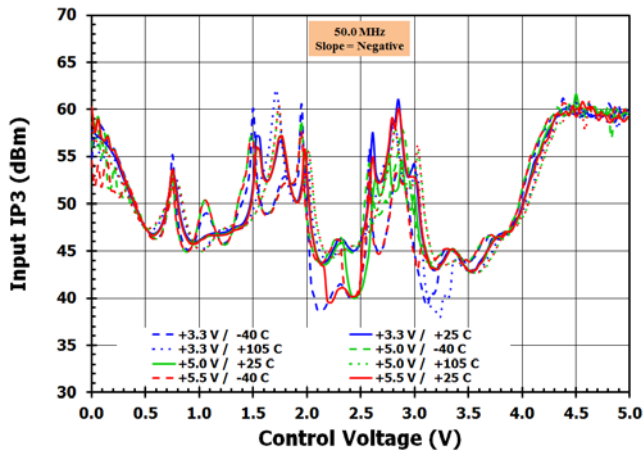

Figure 26. Input IP3 vs.  $V_{CTRL}$   
[50MHz,  $V_{MODE} = HIGH$ ]

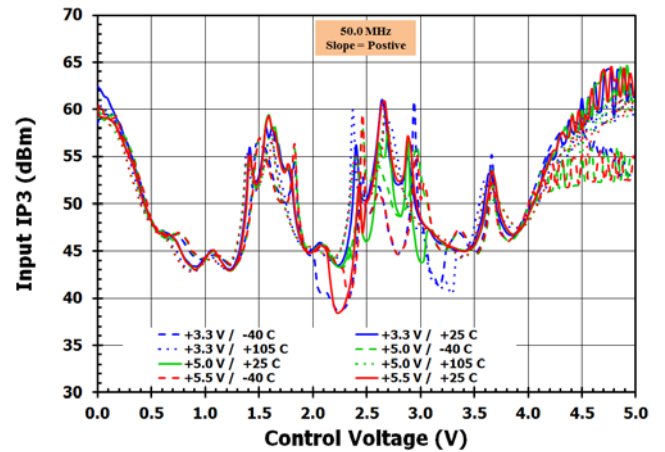

Figure 27. Input IP3 vs.  $V_{CTRL}$   
[1.2GHz,  $V_{MODE} = LOW$ ]

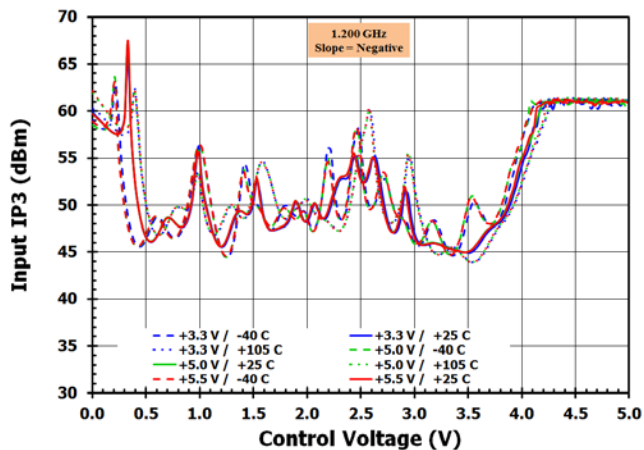
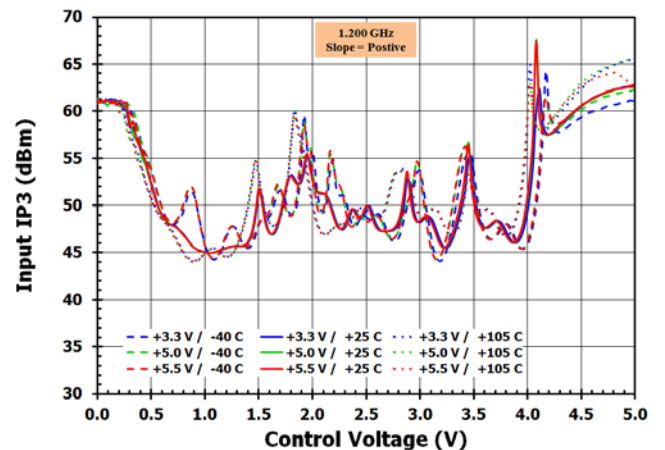

Figure 28. Input IP3 vs.  $V_{CTRL}$   
[1.2GHz,  $V_{MODE} = HIGH$ ]



## Typical Performance Characteristics (No External RF Tuning)

Figure 29. Compression vs. Input Power  
[5MHz,  $V_{MODE} = LOW, V_{CTRL} = 0V$ ]

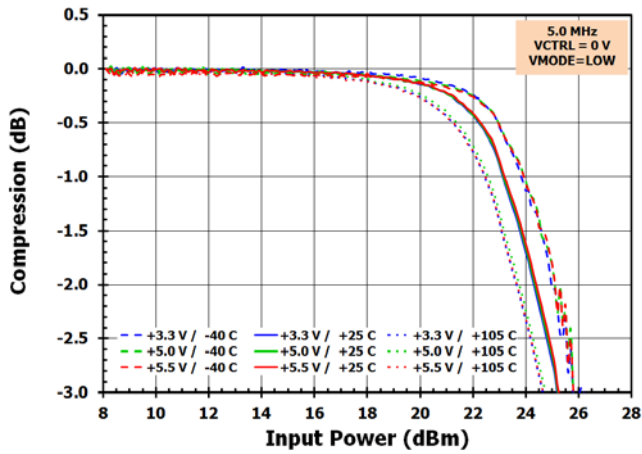

Figure 30. Compression vs. Input Power  
[5MHz,  $V_{MODE} = HIGH, V_{CTRL} = 5V$ ]

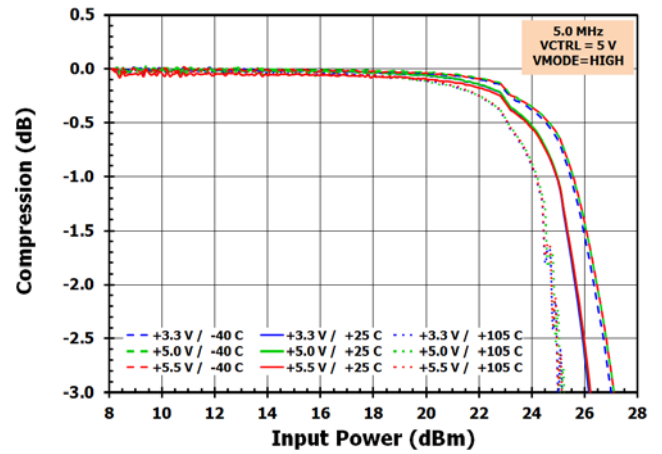

Figure 31. Compression vs. Input Power  
[100MHz,  $V_{MODE} = LOW, V_{CTRL} = 0V$ ]

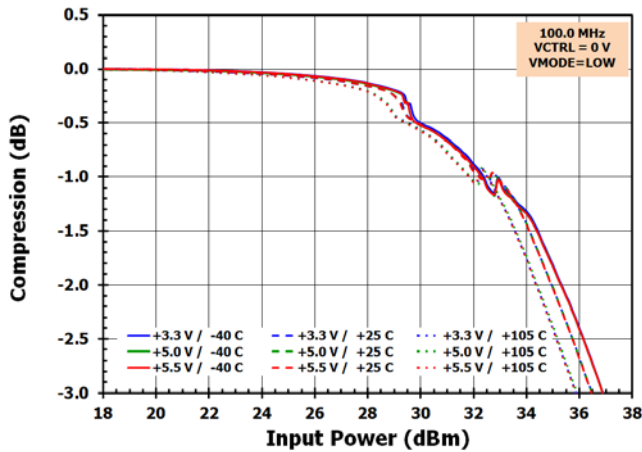

Figure 32. Compression vs. Input Power  
[100MHz,  $V_{MODE} = HIGH, V_{CTRL} = 5V$ ]

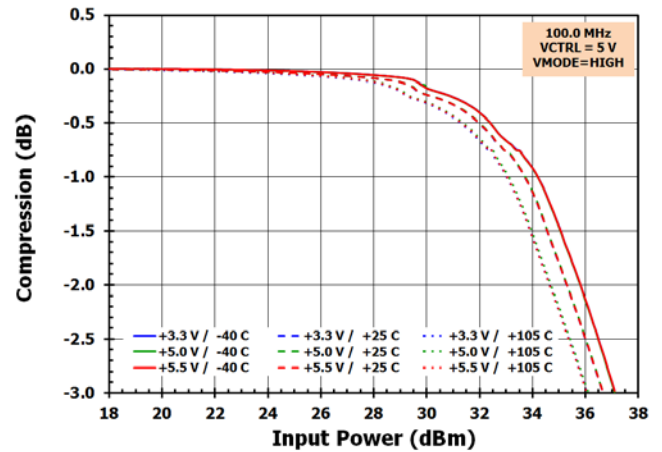

Figure 33. Compression vs. Input Power  
[1.2GHz,  $V_{MODE} = LOW, V_{CTRL} = 0V$ ]

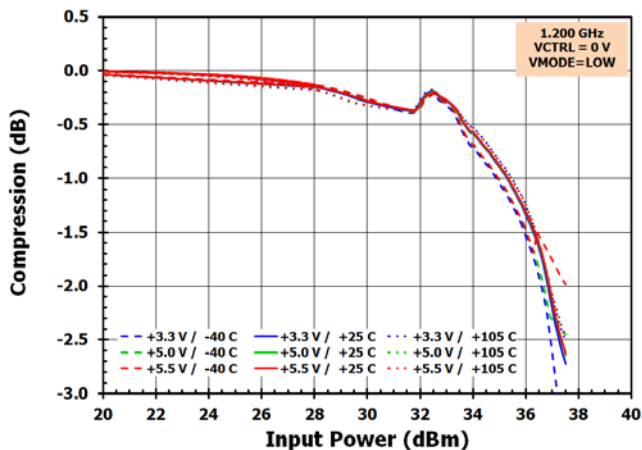
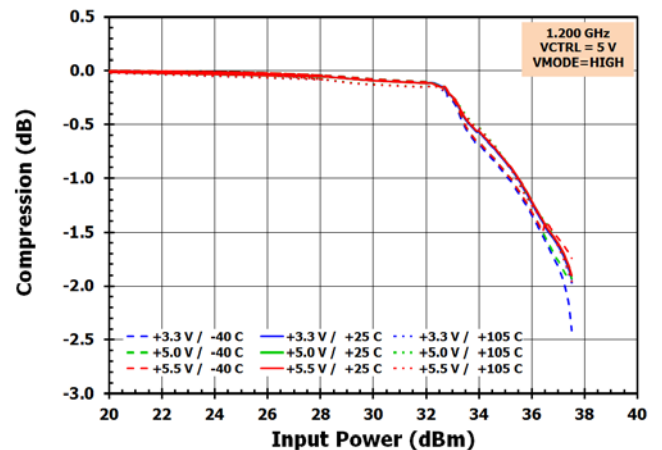

Figure 34. Compression vs. Input Power  
[1.2GHz,  $V_{MODE} = HIGH, V_{CTRL} = 5V$ ]



Typical Performance Characteristics (Extended Bandwidth Tuning)

Figure 35. Insertion Loss vs. Frequency  
[V<sub>MODE</sub> = LOW]

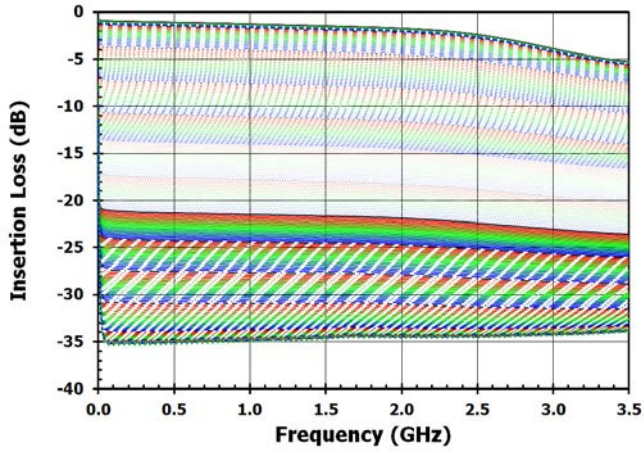

Figure 36. Relative Insertion Loss vs. V<sub>CTRL</sub>  
[V<sub>MODE</sub> = LOW]

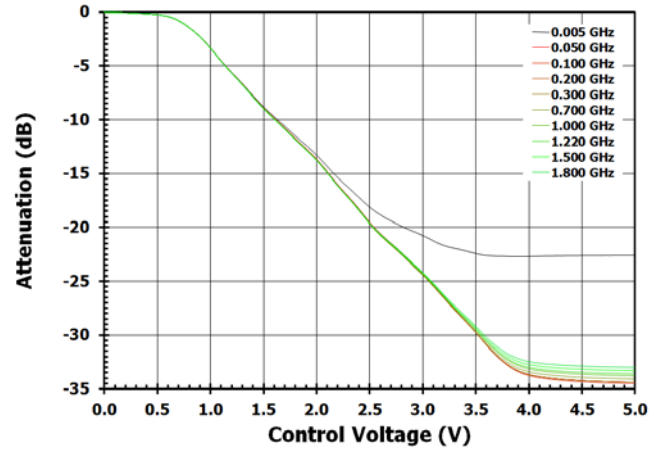

Figure 37. RF1 Return Loss vs. Frequency  
[V<sub>MODE</sub> = LOW]

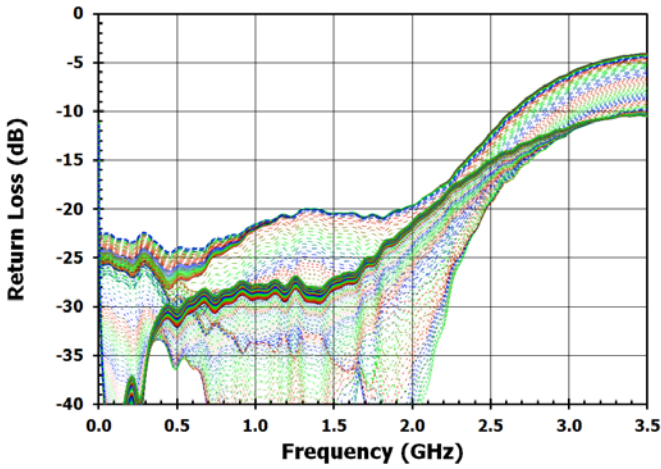

Figure 38. RF1 Return Loss vs. V<sub>CTRL</sub>  
[V<sub>MODE</sub> = LOW]

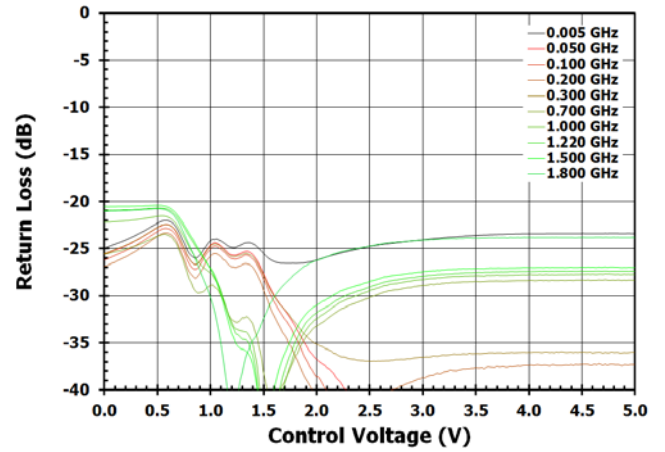

Figure 39. RF2 Return Loss vs. Frequency  
[V<sub>MODE</sub> = LOW]

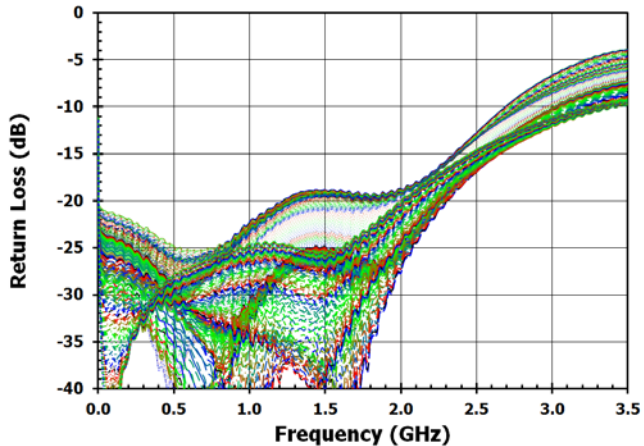
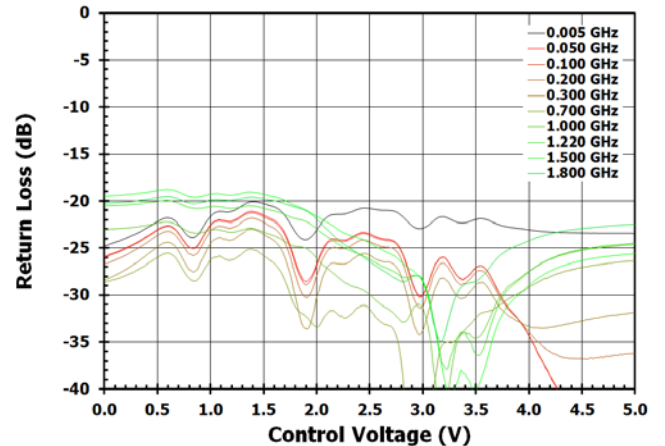

Figure 40. RF2 Return Loss vs. V<sub>CTRL</sub>  
[V<sub>MODE</sub> = LOW]





## Typical Performance Characteristics (Extended Bandwidth Tuning)

Figure 41. Relative Insertion Phase vs. Frequency [ $V_{MODE} = LOW$ ]

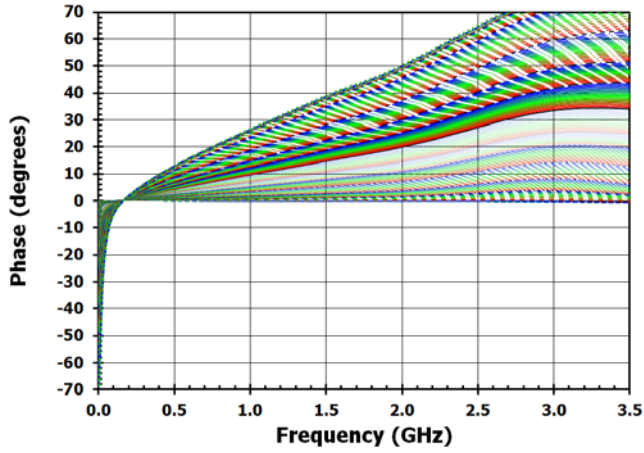

Figure 42. Relative Insertion Phase vs.  $V_{CTRL}$  [ $V_{MODE} = LOW$ ]

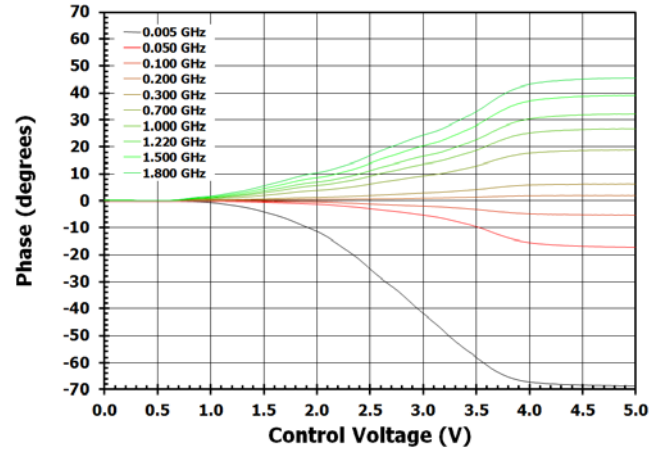

Figure 43. RF1 Return Loss vs. Frequency [ $V_{MODE} = LOW$ ]

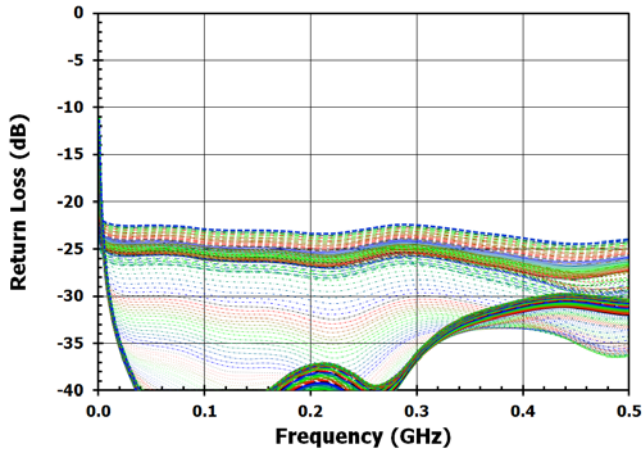

Figure 44. Attenuation Slope vs.  $V_{CTRL}$  [ $V_{MODE} = LOW$ ]

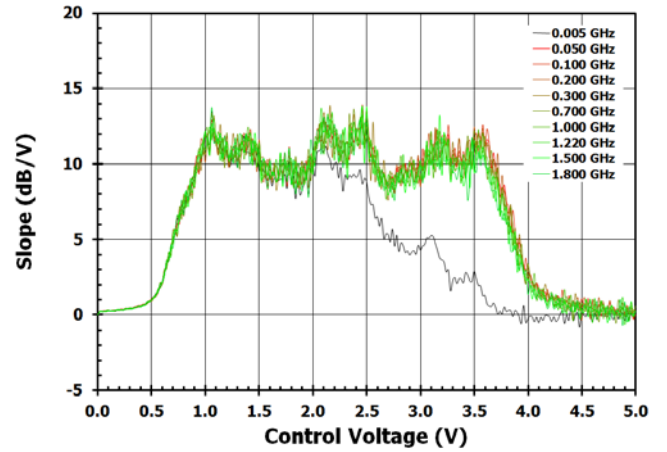
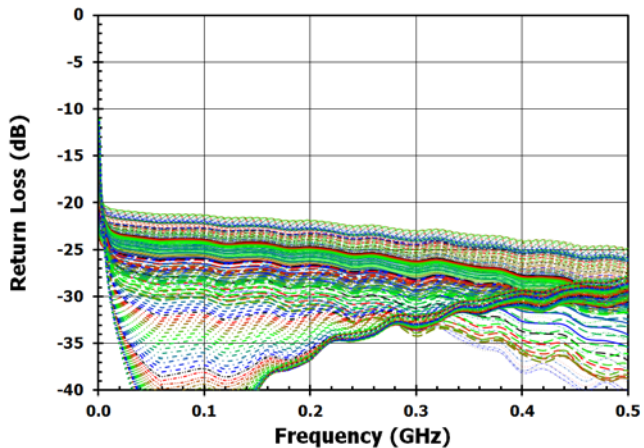

Figure 45. RF2 Return Loss vs. Frequency [ $V_{MODE} = LOW$ ]



Typical Performance Characteristics (Extended Bandwidth Tuning)

Figure 46. Insertion Loss vs. Frequency  
[V<sub>MODE</sub> = HIGH]

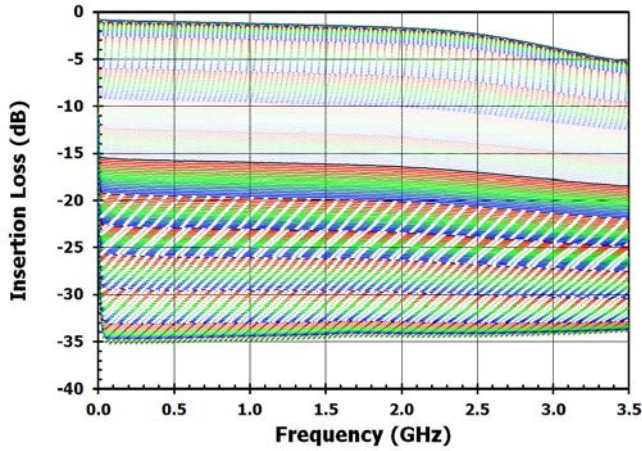

Figure 47. Relative Insertion Loss vs. V<sub>CTRL</sub>  
[V<sub>MODE</sub> = HIGH]

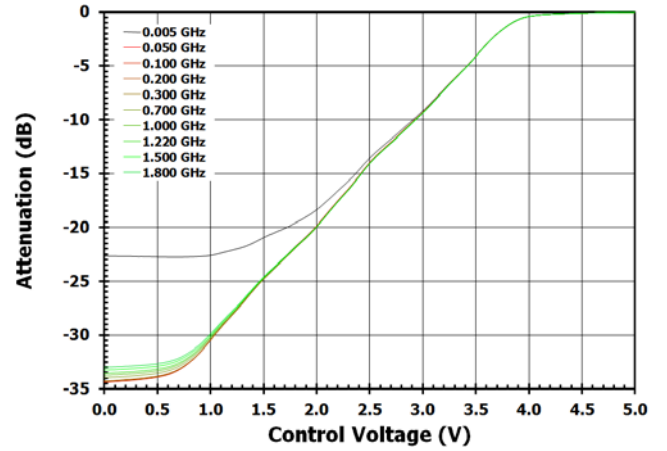

Figure 48. RF1 Return Loss vs. Frequency  
[V<sub>MODE</sub> = HIGH]

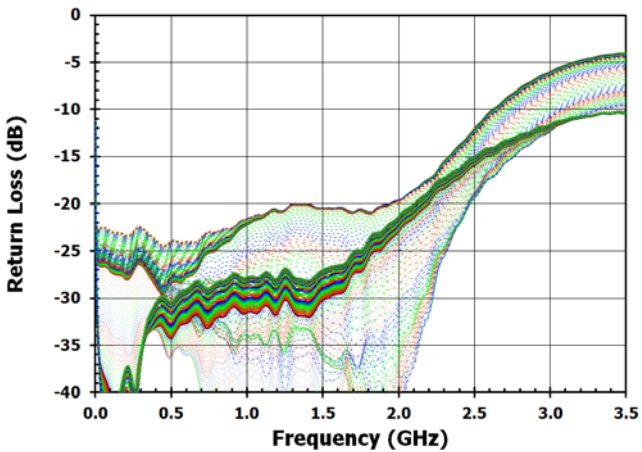

Figure 49. RF1 Return Loss vs. V<sub>CTRL</sub>  
[V<sub>MODE</sub> = HIGH]

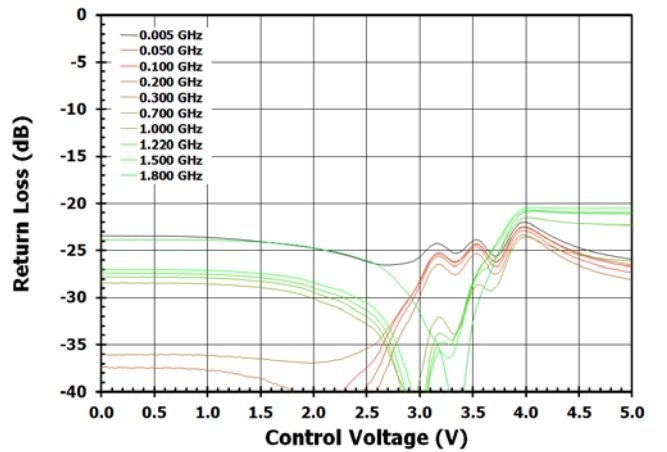

Figure 50. RF2 Return Loss vs. Frequency  
[V<sub>MODE</sub> = HIGH]

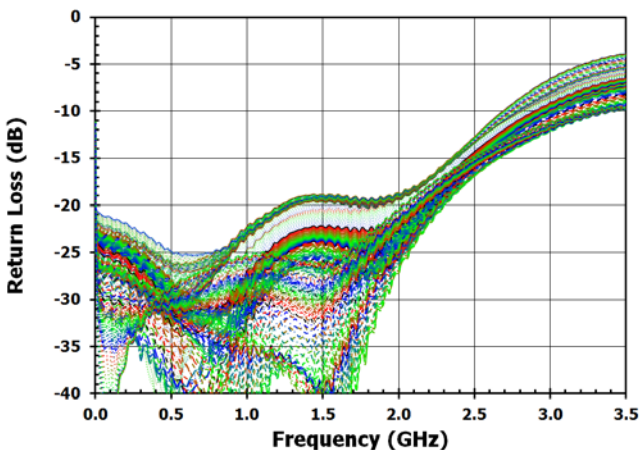
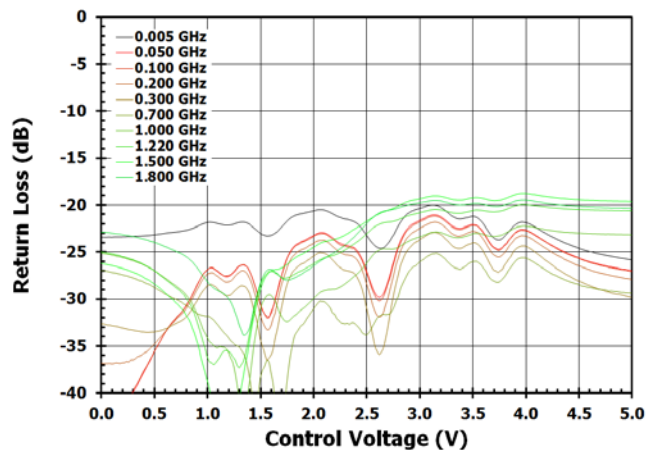

Figure 51. RF2 Return Loss vs. V<sub>CTRL</sub>  
[V<sub>MODE</sub> = HIGH]



Typical Performance Characteristics (Extended Bandwidth Tuning)

Figure 52. Relative Insertion Phase vs. Frequency [ $V_{MODE} = HIGH$ ]

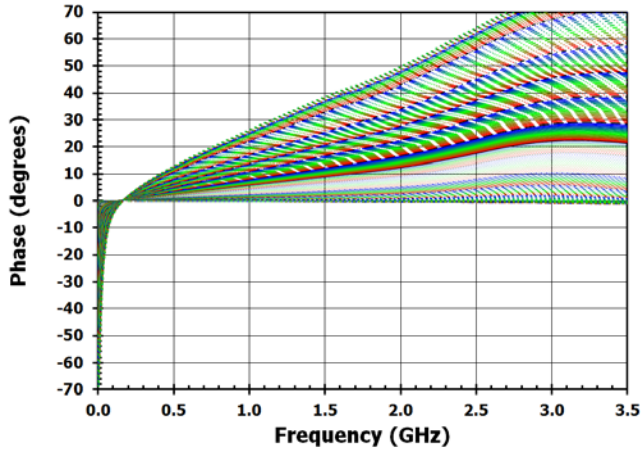

Figure 53. Relative Insertion Phase vs.  $V_{CTRL}$  [ $V_{MODE} = HIGH$ ]

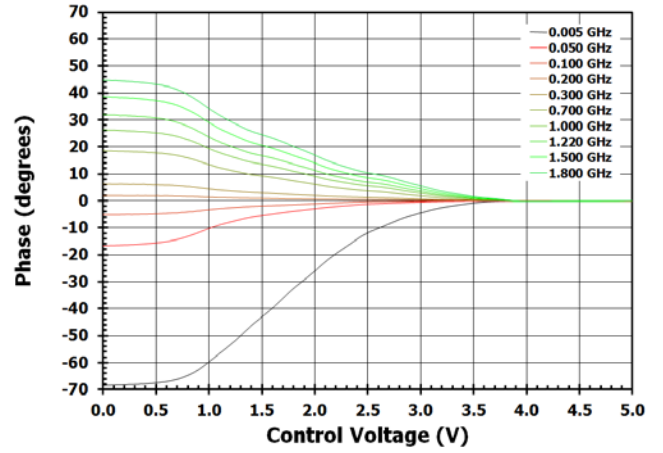

Figure 54. RF1 Return Loss vs. Frequency [ $V_{MODE} = HIGH$ ]

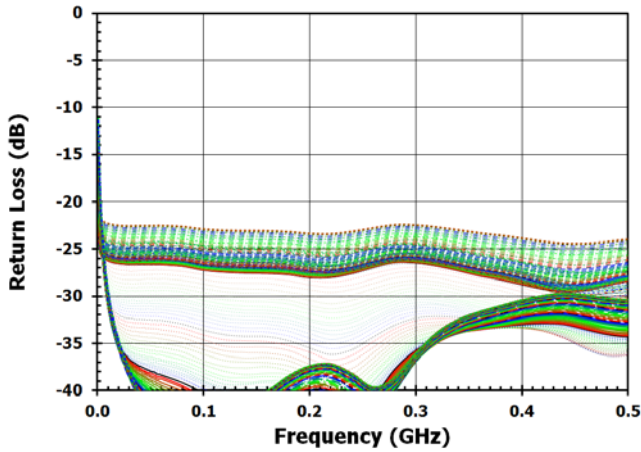

Figure 55. Attenuation Slope vs.  $V_{CTRL}$  [ $V_{MODE} = HIGH$ ]

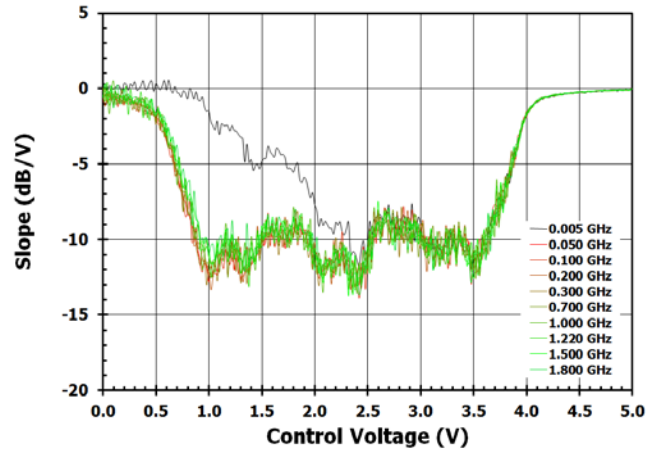
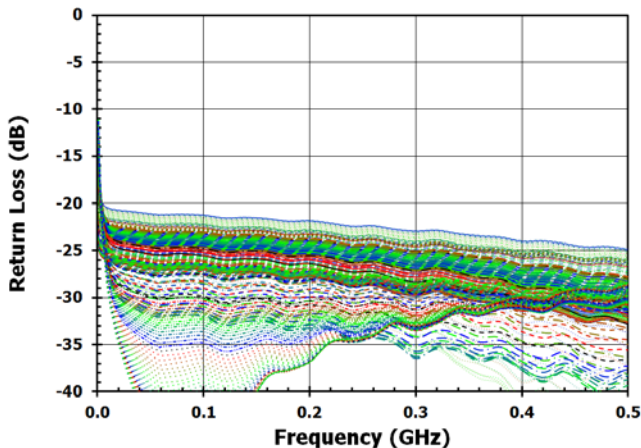

Figure 56. RF2 Return Loss vs. Frequency [ $V_{MODE} = HIGH$ ]



## Application Information

The F2270 has been optimized for use in high performance RF applications from 5MHz to 1800MHz and has a full operating range of 5MHz to 3000MHz.

### Default Start-up

$V_{MODE}$  should be tied to either logic LOW (ground) or logic HIGH. If the  $V_{CTRL}$  pin is left floating, the part will power up in the minimum attenuation state when  $V_{MODE} = LOW$  or in the maximum attenuation state when  $V_{MODE} = HIGH$ .

#### $V_{MODE}$

The  $V_{MODE}$  pin is used to set the slope of the attenuation. The attenuation is varied by  $V_{CTRL}$  as described in the next section. Setting  $V_{MODE}$  to a logic LOW (HIGH) will set the attenuation slope to negative (positive). A negative (positive) slope is defined as an increased (decreased) attenuation with increasing  $V_{CTRL}$  voltage. The Evaluation Kit provides has an on-board jumper to manually set  $V_{MODE}$ . Install a jumper on header J7 from  $V_{MODE}$  to the pin marked Lo (Hi) to set the device for a negative (positive) slope (see Figure 58).

#### $V_{CTRL}$

The voltage level on the  $V_{CTRL}$  pin is used to control the attenuation of the F2270. At  $V_{CTRL} = 0V$ , the attenuation is a minimum (maximum) in the negative (positive) slope mode. An increasing voltage on  $V_{CTRL}$  produces an increasing (decreasing) attenuation respectively. The  $V_{CTRL}$  pin has an on-chip pull-up ESD diode so  $V_{DD}$  should be applied before  $V_{CTRL}$  is applied (see "Recommended Operating Conditions" for details). If this sequencing is not possible, then resistor R5 in the application circuit (see Figure 60) should be set to  $1k\Omega$  to limit the current into the  $V_{CTRL}$  pin.

### RF1 and RF2 Ports

The F2270 is a bi-directional device, allowing RF1 or RF2 to be used as the RF input. RF1 has some enhanced linearity performance, and therefore should be used as the RF input, when possible, for best results. The F2270 has been designed to accept high RF input power levels; therefore,  $V_{DD}$  must be applied prior to the application of RF power to ensure reliability. DC blocking capacitors are required on the RF pins and should be set to a value that results in a low reactance over the frequency range of interest. External series inductors can be added on the RF1 and RF2 lines close to the device to improve the higher frequency match.

### Power Supplies

The  $V_{DD}$  supply pin should be bypassed with external capacitors to minimize noise and fast transients. Supply noise can degrade performance, and fast transients can trigger ESD clamps and cause them to fail. Supply voltage changes or transients should have a slew rate smaller than  $1V/20\mu s$ . In addition, all control pins should remain at  $0V (+/- 0.3V)$  while the supply voltage ramps or while it returns to zero.

### Control Pin Interface

If control signal integrity is a concern and clean signals cannot be guaranteed due to overshoot, undershoot, or ringing, etc., then implementing the circuit shown in Figure 57 at the input of each control pin is recommended. This applies to control pins 14 ( $V_{CTRL}$ ) and 16 ( $V_{MODE}$ ) as shown in Figure 57. Note the recommended resistor and capacitor values do not necessarily match the Evaluation Kit BOM for the case of poor control signal integrity.

### Extended Bandwidth Tuning (EBT)

There are cases where the return loss for the RF ports needs to be better than 18 dB across the frequency range. For this case, adding series inductors just next to the package on the RF ports will accomplish this. The addition of these inductors,  $2.4nH$  on RF1 and  $2.8nH$  on RF2, will degrade the insertion loss and return loss at frequencies above 2GHz.

Figure 57. Control Pin Interface for Signal Integrity

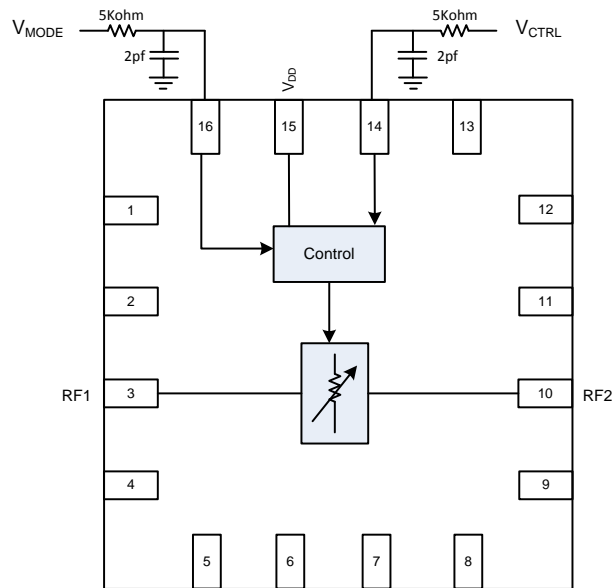

## Evaluation Kit Pictures

Figure 58. Evaluation Kit Top View

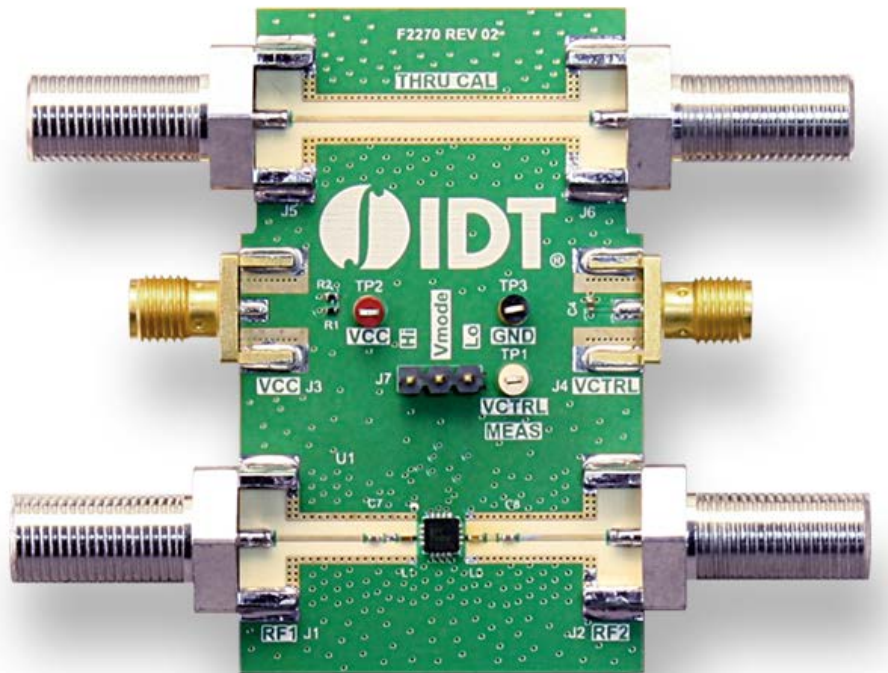
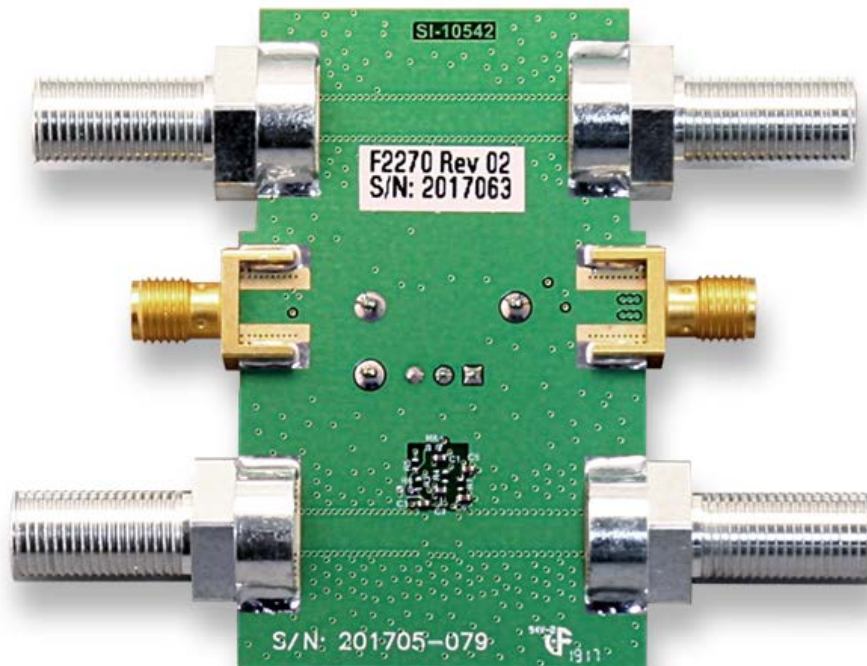

Figure 59. Evaluation Kit Bottom View



# Evaluation Kit / Applications Circuit

Figure 60. Electrical Schematic

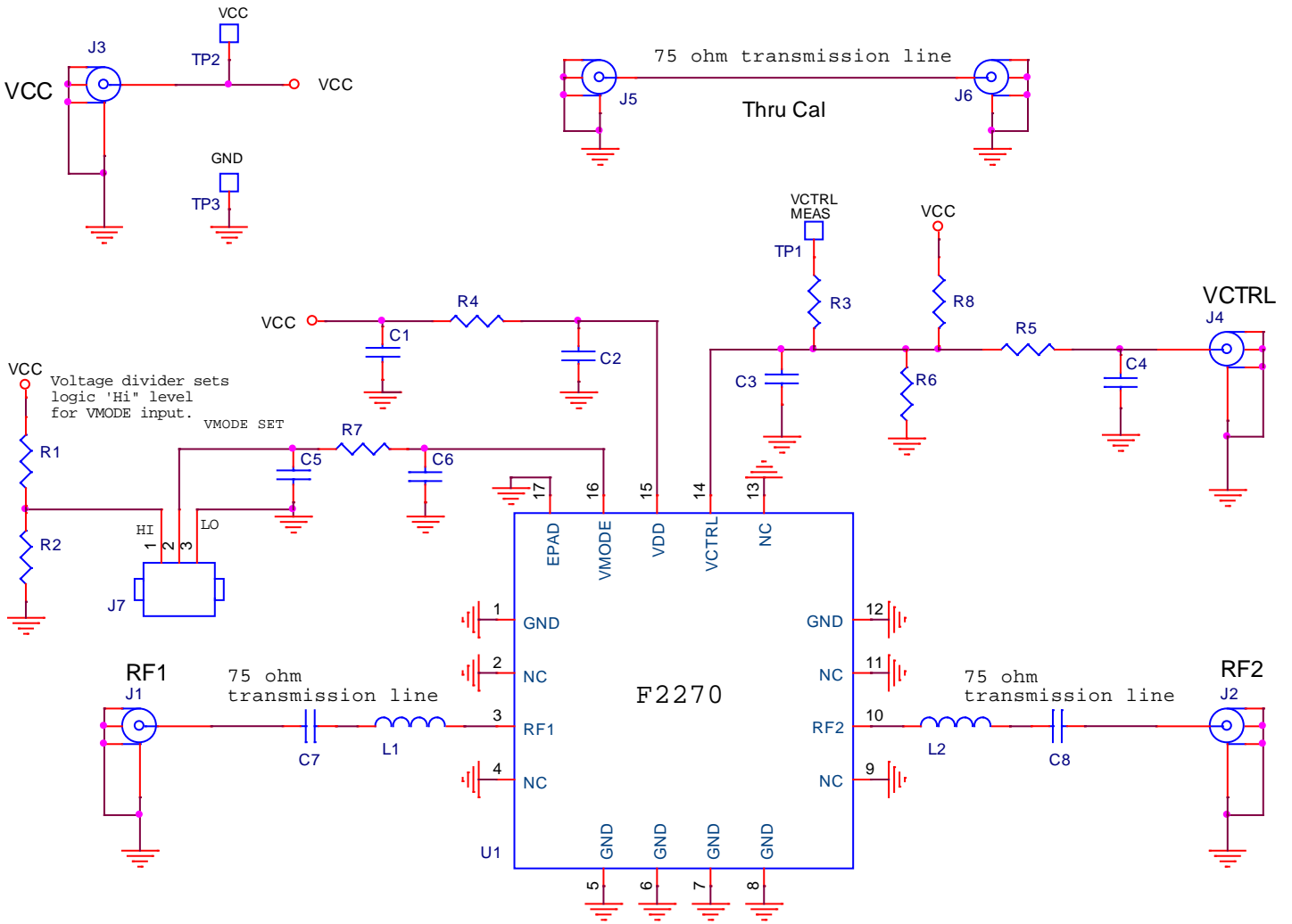

Table 8. Bill of Material (BOM)

Part Reference	QTY	Description	Manufacturer Part #	Manufacturer
C1 – C8	8	0.1 $\mu$ F $\pm$ 10%, 16V, X7R Ceramic Capacitor (0402)	GRM155R71C104K	Murata
R1, R2, R3	3	100k $\Omega$ $\pm$ 1%, 1/10W, Resistor (0402)	ERJ-2RKF1003X	Panasonic
R4	1	10 $\Omega$ $\pm$ 1%, 1/10W, Resistor (0402)	ERJ-2RKF10R0X	Panasonic
R5	1	1k $\Omega$ $\pm$ 1%, 1/10W, Resistor (0402)	ERJ-2RKF1001X	Panasonic
R7	1	100 $\Omega$ $\pm$ 1%, 1/10W, Resistor (0402)	ERJ-2RKF1000X	Panasonic
L1 [a]	0	0 $\Omega$ $\pm$ 1%, 1/10W, Resistor (0402)	ERJ-2GE0R00X	Panasonic
	1	2.4nH $\pm$ 0.1nH, Inductor (0402)	LQP15MN2N4B02D	Murata
L2 [a]	0	0 $\Omega$ $\pm$ 1%, 1/10W, Resistor (0402)	ERJ-2GE0R00X	Panasonic
	1	2.8nH $\pm$ 0.1nH, Inductor (0402)	LQP15MN2N8B02D	Murata
J1, J2, J5, J6	4	Edge Launch F TYPE 75 $\Omega$	222181	Amphenol
J3, J4	2	Edge Launch SMA (0.375 inch pitch ground, tab)	142-0701-851	Emerson Johnson
J7	1	Conn Header Vertical SGL 3 X 1 Pos Gold	961103-6404-AR	3M
TP1	1	Test Point White	5002	Keystone Electronics
TP2	1	Test Point Red	5000	Keystone Electronics
TP3	1	Test Point Black	5001	Keystone Electronics
U1	1	75 $\Omega$ Voltage Variable Attenuator	F2270NLGK	IDT
	1	Printed Circuit Board	F2270 Rev 02	IDT
R6, R8	0	DNP		

[a] Series inductors are added on the RF port to improve the high-frequency port match (extended band). If not required then the 0 $\Omega$  resistor can be used.



## Evaluation Kit Operation

Below is a basic setup procedure for configuring and testing the F2270 Evaluation Kit (EVKit).

### Pre-Configure EVKit

This section is a guide to setting up the EVKit for testing. To configure the board for a negative attenuation slope (increasing attenuation with increasing  $V_{CTRL}$  voltage), install a header-shunt shorting pin 2 (center pin) and pin 3 (labeled Lo) on header J7 (see Figure 58). For a positive slope (decreasing attenuation with increasing  $V_{CTRL}$  voltage), this header-shunt should short pin 1 (labeled Hi) to pin 2 (center pin) on J7.

### Power Supply Setup

Without making any connections to the EVKit, set up one fixed power supply ( $V_{CC}$ ) for 5V with a current limit of 10mA and one variable power supply ( $V_{CTRL}$ ) set to 0V with a current limit of 5mA. Disable both power supplies.

### RF Test Setup

Set the RF test setup to the desired frequency and power ranges within the specified operating limits noted in this datasheet.

Disable the output power of all the RF sources.

Connect EVKit to the test setup.

With the RF sources and power supplies disabled, connect the fixed 5V power supply to connector J3, the variable supply to J4, and the RF connections to the desired RF ports.

### Powering Up the EVKit

Enable the  $V_{CC}$  power supply and observe a DC current of approximately 1.4mA.

Enable the  $V_{CTRL}$  power supply.

Enable the RF sources. Verify that the DC current remains at about 1.4mA.

If the J7 connection is set for a negative (positive) attenuation slope, then increasing the variable supply will produce increased (decreased) attenuation for the attenuator path (J1 to J2).

### Powering Down the EVKit

Disable the RF power applied to the device.

Adjust the  $V_{CTRL}$  power supply down to 0V and disable it.

Disable the  $V_{CC}$  power supply.

Disconnect the EVKit from the RF test setup.

## Package Outline Drawings

The package outline drawings are appended at the end of this document and are accessible from the link below. The package information is the most current data available.

[www.idt.com/document/psc/16-vfqfpn-package-outline-drawing-30-x-30-x-09-mm-05-mm-170-x-170-mm-epad-nlnlg16p2](http://www.idt.com/document/psc/16-vfqfpn-package-outline-drawing-30-x-30-x-09-mm-05-mm-170-x-170-mm-epad-nlnlg16p2)

## Marking Diagram

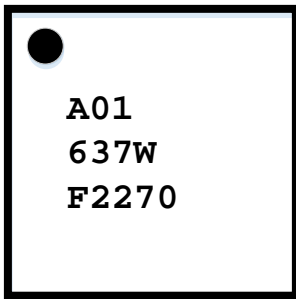

Line 1 "A01" is for lot code.

Line 2 "637" = has one digit for the year and week that the part was assembled.

Line 2 "W" is the assembler code.

Line 3 is the abbreviated part number.

## Ordering Information

Orderable Part Number	Package	MSL Rating	Shipping Packaging	Operating Temperature
F2270NLGK	3.0 × 3.0 × 0.9 mm 16-VFQFPN	1	Tray	-40°C to +105°C
F2270NLGK8	3.0 × 3.0 × 0.9 mm 16-VFQFPN	1	Reel	-40°C to +105°C
F2270EVBI	Evaluation Board			

## Revision History

Revision Date	Description of Change
January 16, 2019	Changed the control pin leakage current to reflect the actual measured values.
July 25, 2017	Initial release

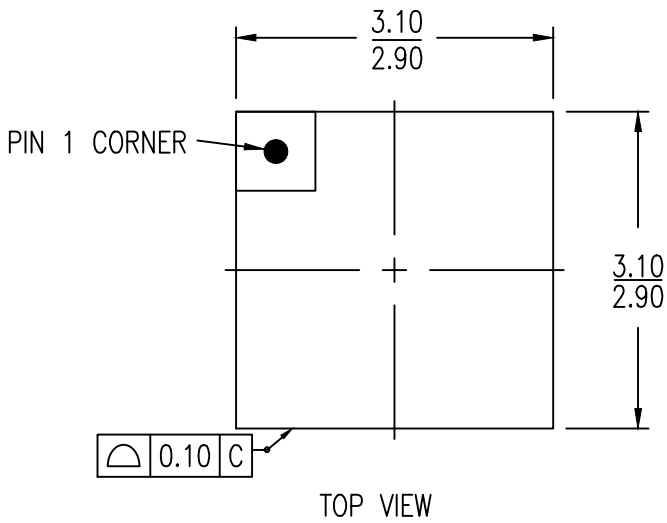

NOTES:  
1. ALL DIMENSIONS ARE IN mm. ANGLES IN DEGREES



RECOMMENDED LAND PATTERN DIMENSION

NOTES:

1. ALL DIMENSIONS ARE IN mm. ANGLES IN DEGREES
2. TOP DOWN VIEW-AS VIEWED ON PCB
3. LAND PATTERN RECOMMENDATION IS PER IPC-7351B GENERIC REQUIREMENT FOR SURFACE MOUNT DESIGN AND LAND PATTERN

Package Revision History		
Date Created	Rev No.	Description
Oct 25, 2017	Rev 04	Remove Bookmak at Pdf Format & Update Thickness Tolerance
Jan 18, 2018	Rev 05	Change QFN to VFQFPN

## IMPORTANT NOTICE AND DISCLAIMER

RENESAS ELECTRONICS CORPORATION AND ITS SUBSIDIARIES (“RENESAS”) PROVIDES TECHNICAL SPECIFICATIONS AND RELIABILITY DATA (INCLUDING DATASHEETS), DESIGN RESOURCES (INCLUDING REFERENCE DESIGNS), APPLICATION OR OTHER DESIGN ADVICE, WEB TOOLS, SAFETY INFORMATION, AND OTHER RESOURCES “AS IS” AND WITH ALL FAULTS, AND DISCLAIMS ALL WARRANTIES, EXPRESS OR IMPLIED, INCLUDING, WITHOUT LIMITATION, ANY IMPLIED WARRANTIES OF MERCHANTABILITY, FITNESS FOR A PARTICULAR PURPOSE, OR NON-INFRINGEMENT OF THIRD PARTY INTELLECTUAL PROPERTY RIGHTS.

These resources are intended for developers skilled in the art designing with Renesas products. You are solely responsible for (1) selecting the appropriate products for your application, (2) designing, validating, and testing your application, and (3) ensuring your application meets applicable standards, and any other safety, security, or other requirements. These resources are subject to change without notice. Renesas grants you permission to use these resources only for development of an application that uses Renesas products. Other reproduction or use of these resources is strictly prohibited. No license is granted to any other Renesas intellectual property or to any third party intellectual property. Renesas disclaims responsibility for, and you will fully indemnify Renesas and its representatives against, any claims, damages, costs, losses, or liabilities arising out of your use of these resources. Renesas' products are provided only subject to Renesas' Terms and Conditions of Sale or other applicable terms agreed to in writing. No use of any Renesas resources expands or otherwise alters any applicable warranties or warranty disclaimers for these products.

(Rev.1.0 Mar 2020)

### Corporate Headquarters

TOYOSU FORESIA, 3-2-24 Toyosu,  
Koto-ku, Tokyo 135-0061, Japan  
[www.renesas.com](http://www.renesas.com)

### Contact Information

For further information on a product, technology, the most up-to-date version of a document, or your nearest sales office, please visit:  
[www.renesas.com/contact/](http://www.renesas.com/contact/)

### Trademarks

Renesas and the Renesas logo are trademarks of Renesas Electronics Corporation. All trademarks and registered trademarks are the property of their respective owners.