



# **MTR105**

## **Rotating Machine Tester**

*User Guide*

**This document is copyright of:**

Megger Limited, Archcliffe Road, Dover, Kent CT17 9EN. ENGLAND  
T +44 (0)1304 502101 F +44 (0)1304 207342 [www.megger.com](http://www.megger.com)

Megger Limited reserves the right to alter the specification of its products from time to time without notice. Although every effort is made to ensure the accuracy of the information contained within this document it is not warranted or represented by Megger Limited to be a complete and up-to-date description.

For Patent information about this instrument refer to the following web site:  
[megger.com/patents](http://megger.com/patents)

This manual supersedes all previous issues of this manual. Please ensure that you are using the most recent issue of this document. Destroy any copies that are of an older issue.

## **Declaration of Conformity**

Hereby, Megger Instruments Limited declares that radio equipment manufactured by Megger Instruments Limited described in this user guide is in compliance with Directive 2014/53/EU. Other equipment manufactured by Megger Instruments Limited described in this user guide is in compliance with Directives 2014/30/EU and 2014/35/EU where they apply.

The full text of Megger Instruments EU declarations of conformity are available at the following internet address:

[megger.com/company/about-us/eu-dofc](http://megger.com/company/about-us/eu-dofc)

# Contents

<b>1. Safety Warnings</b>	<b>2</b>
1.1 Warnings, Cautions and Notes	2
1.1.1 Warnings	2
1.1.2 Cautions	2
1.1.3 Notes	2
1.2 Safety warnings	2
1.2.1 Test lead safety warnings	3
1.3 Product Safety Category - Measurement Connection	3
1.3.1 Voltage	3
1.3.2 CAT IV	3
1.3.3 CAT III	3
1.3.4 CAT II	3
1.4 Safety, Hazard and Warning Symbols on the Instrument	4
1.4.1 Warning Icons	4
<b>2. Introduction</b>	<b>5</b>
2.1 Product Description	5
2.2 Applications	6
2.3 Features	6
2.4 Company web site	6
2.5 In the box	6
2.6 Instrument Controls	7
2.7 Instrument Display	8
2.8 Instrument Controls	9
2.9 Instrument Connections and Leads	10
2.9.1 View on top of MTR105	10
<b>3. Instrument Set up</b>	<b>11</b>
3.1 Warnings and exception conditions	11
3.2 Power	11
3.2.1 First use	11
3.2.2 Turn the instrument on and off	11
3.2.3 Power options	12
3.3 Initial test set up	12
3.3.1 Test Lead connections	13
3.4 Lockout Voltage	15
3.5 Temperature compensation	16
3.5.1 Example for using Temperature compensation	16

<b>4. Insulation Resistance Tests</b>	<b>17</b>
4.1 Insulation test options.....	17
4.2 Two Terminal and Guard.....	17
4.3 Automatic discharge .....	18
4.4 IR Buzzer settings .....	18
4.5 Insulation Resistance test display .....	19
4.6 IR Test sequence.....	20
4.7 3 Phase (3P).....	21
4.8 Polarization Index (PI) .....	22
4.9 Timed (T(s)) Test.....	24
4.10 Dielectric Absorption Ratio (DAR) .....	25
4.11 Variable voltage .....	27
<b>5. Voltmeter</b>	<b>28</b>
5.1 Voltage test display .....	28
5.2 TRMS (True RMS) .....	28
5.3 AC or DC .....	29
5.4 Supply Phase Rotation.....	30
<b>6. Continuity</b>	<b>31</b>
6.1 Continuity test display .....	31
6.2 Uni-direction.....	32
6.3 3 Phase Continuity.....	33
6.4 Bi-direction .....	36
6.5 Diode test.....	37
<b>7. DLRO Digital Low Resistance Ohmmeter</b>	<b>39</b>
7.1 DLRO display .....	39
7.1.1 Uni/Bi-direction test display .....	39
7.1.2 3-Phase test display.....	40
7.2 Manual single direction test.....	40
7.3 Auto Single direction test.....	42
7.4 Manual bi-direction test.....	43
7.5 Auto Bi direction test.....	45
7.6 DLRO 3 Phase.....	46
7.7 Test failure .....	48
7.7.1 Lost connection.....	48

<b>8. Direction of Motor Rotation</b>	<b>49</b>
<b>9. Inductance (L); Capacitance (C); Resistance (R) (LCR)</b>	<b>50</b>
9.1 LCR test display .....	50
9.1.1 Capacitance, Inductance, Auto test display.....	50
9.1.2 3-Phase test display.....	50
9.2 Auto .....	51
9.3 Capacitance or inductance.....	52
9.4 LCR 3 Phase .....	53
9.5 LCR Calibration .....	56
<b>10. Temperature measurement</b>	<b>58</b>
10.1 Thermocouple temperature measurement.....	58
10.2 Manual Temperature measurement.....	60
<b>11. Data management</b>	<b>62</b>
11.1 Creating a new asset ID .....	62
11.2 Using an existing asset ID.....	63
11.3 Deleting an asset .....	64
11.4 Deleting items from within an asset .....	65
11.5 Deleting a single test .....	66
11.6 Exporting entries to USB .....	68
<b>12. Firmware update</b>	<b>71</b>
<b>13. Error and Warning Conditions</b>	<b>73</b>
13.1 Failed export.....	73
13.2 Fuse Failure .....	73
13.3 Battery Low.....	73
<b>14. Settings</b>	<b>74</b>
14.1 Test settings navigation .....	74
14.2 IR test settings .....	75
14.2.1 DAR Settings.....	75
14.2.2 Insulation threshold.....	75
14.2.3 Lock.....	75
14.2.4 Temperature compensation and motor class.....	76
14.2.5 Terminal lock out.....	76
14.2.6 Timed Insulation.....	76
14.2.7 Variable Voltage .....	76
14.3 Continuity Settings.....	77
14.3.1 Continuity temperature compensation .....	77

<b>14.4</b>	<b>General Settings</b> .....	<b>77</b>
14.4.1	Back-light timer.....	77
14.4.2	Battery Technology.....	77
14.4.3	Date.....	78
14.4.4	Instrument information .....	78
14.4.5	Key Press Notification .....	78
14.4.6	Sleep timer.....	78
14.4.7	Time .....	79
14.4.8	Restore factory settings .....	79
14.4.9	Screen shot .....	79
14.4.10	To take a screen shot.....	79
<b>14.5</b>	<b>Language settings</b> .....	<b>80</b>
<b>15.</b>	<b>Maintenance</b> .....	<b>81</b>
15.1	General Maintenance.....	81
15.2	Cleaning.....	81
15.3	Battery.....	81
15.3.1	Battery status .....	81
15.3.2	12 V supply.....	82
15.3.3	Battery Charging.....	82
<b>15.3.4</b>	<b>Battery error screens</b> .....	<b>82</b>
15.4	Battery and Fuse Replacement .....	83
15.4.1	Replace battery cells and remove isolation tab.....	84
15.4.2	To replace the fuses.....	84
<b>16.</b>	<b>Specifications</b> .....	<b>85</b>
<b>17.</b>	<b>Accessories and Equipment</b> .....	<b>88</b>
17.1	Included Accessories.....	88
17.2	Optional Accessories.....	88
<b>18.</b>	<b>Calibration, Repair and Warranty</b> .....	<b>89</b>
18.1	Return procedure .....	89
<b>19.</b>	<b>Decommissioning</b> .....	<b>90</b>
19.1	WEEE Directive .....	90
19.2	Battery disposal .....	90

## 1. Safety Warnings

The safety instructions given in this document are indicative of safe practice and are not be considered exhaustive. Additionally, they are not intended to replace local safety procedures in the region where the instrument is used. If the equipment is used in a manner not specified by the manufacturer, the protection provided by the equipment may be impaired.

### 1.1 Warnings, Cautions and Notes

This user guide follows the internationally recognized definition of warnings, cautions and s. These instructions must be adhered to at all times.

#### 1.1.1 Warnings

Warnings alert the reader to hazardous situations where injury to personnel can occur. They are set in red type to make them stand out. They are placed before the item to which they relate and repeated at each applicable occasion.

#### 1.1.2 Cautions

Cautions alert the reader to situations where equipment damage may result if a process is not followed properly. They are set in bold type. They are placed before the item to which they relate and repeated at each applicable occasion.

#### 1.1.3 Notes

Notes give additional important information that will help the reader. They are not used when a Warning or Caution is applicable. They are not safety related and may be placed either before or after the associated text as required.

### 1.2 Safety warnings

These safety warnings must be read and understood before the instrument is used. Retain for future reference.

**WARNING : This instrument must be operated only by suitably trained and competent people. Protection provided by the instrument may be impaired if it is not used in a manner specified by the manufacturer.**

- Local Health and Safety Legislation requires users of this equipment and their employers to carry out valid risk assessments of all electrical work to identify potential sources of electrical danger and risk of electrical injury such as inadvertent short circuits. Where the assessments show that the risk is significant then the use of fused test leads may be appropriate.
- The voltage indicator and automatic discharge features must be regarded as additional safety features and not a substitute for normal safe working practice which **MUST** be followed.
- The circuit under test must be switched off, de-energized, securely isolated and proved dead before test connections are made unless measuring voltage or phase rotation.
- Circuit connections, exposed conductive parts and other metalwork of an installation or equipment under test must not be touched during testing.
- When inductive loads are measured it is essential that the current carrying leads are securely clamped to the item being tested and that they are not removed before any stored charge has been discharged at the end of the test. Failure to comply with these instructions might result in an arc being produced, which might be dangerous for the instrument and the operator.
- The Voltmeter function will operate only if the instrument is switched on and working correctly.
- After an insulation test, the instrument must be left connected until the circuit has been discharged to a safe voltage.



- The instrument must not be used if any part of it is damaged or if the terminal shutter is missing.
- All test leads, probes and crocodile clips must be in good order, clean and with no broken or cracked insulation.
- Verify the integrity of the test leads before use. Only “Megger” approved test leads must be used with this product.
- The safe maximum limit of a measurement connection is that of the lowest rated component in the measurement circuit formed by the instrument, test leads and any accessory.
- Ensure that hands remain behind finger guards of probes/clips.
- Replacement fuses must be of the correct type and rating. Failure to fit the correctly rated fuse will result in fire and burns hazards and cause damage to the instrument in the event of an overload.
- All covers must be in place whilst conducting tests.
- This product is not intrinsically safe. Do not use in an explosive atmosphere.
- Ensure every cell in the battery compartment is of identical type. Never mix rechargeable and non-chargeable cells.

### 1.2.1 Test lead safety warnings

- The circuit under test must be switched off, de-energized, isolated and checked to be safe before insulation test connections are made. Make sure the circuit is not re-energized while the instrument is connected.
- Test leads, including crocodile clips, must be in good condition, clean, dry and free of broken or cracked insulation. The lead set or its components must not be used if any part of it is damaged.
- The safe maximum limit of a measurement connection is that of the lowest rated component in the measurement circuit formed by the instrument, test leads and any accessories.
- The CAT III 600 V rated thermocouple probe tip and protective ring are conductive. Care must be taken when using the probe on live systems not to short-circuit to adjacent conductors.

## 1.3 Product Safety Category - Measurement Connection

Only Megger supplied test leads designed for this instrument provide the full safety rating.

### 1.3.1 Voltage

The rated measurement connection voltage is the maximum line to earth voltage at which it is safe to connect.

### 1.3.2 CAT IV

Measurement category IV: Equipment connected between the origin of the low-voltage Mains Power supply and the distribution panel.

### 1.3.3 CAT III

Measurement category III: Equipment connected between the distribution panel and the electrical outlets.











### 1.3.4 CAT II

Measurement category II: Equipment connected between the electrical outlets and the User's equipment.

Measurement equipment may be safely connected to circuits at the marked rating or lower. The connection rating is that of the lowest rated component in the measurement circuit.



## 1.4 Safety, Hazard and Warning Symbols on the Instrument

This section details the various safety and hazard icons on the instruments outer case.

Icon	Description
	High Voltage, risk of electric shock.
	Refer to User Guide.
	Equipment complies with current EU directives.
	Equipment complies with current 'C tick' requirements.
	Do not dispose of in the normal waste stream.
	Equipment protected throughout by double insulation.
	Fuse.
<b>CAT III</b> <b>600 V</b> 	CAT rating 600 V AC RMS maximum between terminals and between terminal and earth.
	DC
	Do not use in distribution systems with voltages higher than 1100 V.
<b>IP54</b>	IP rating.

### 1.4.1 Warning Icons

This section details the warning icons that can show on the display.

Icon	Warning	Description
	External Voltage Warning	If an external voltage is applied between the terminals and the instrument is set to On, the High Voltage warning will flash on the display. This is a warning that the item under test is live and might be dangerous and testing is disabled. The High Voltage warning message will flash if more than 50 V potential difference is applied between the Voltage terminals and the Current terminals. This warning will not show if all terminals are at the same high voltage.  The warning will not operate if the instrument is set to Off.
	Internal Error Warning	Internal Error Warning switch off and bACK on. Contact Megger if not cleared.
	Read the User Guide	Refer to the user guide if this message shows.

## 2. Introduction

---

### 2.1 Product Description

This user guide details the operational and functional details of the Megger MTR105 Rotating Machine Tester. Please read this user guide fully before attempting to use the MTR105. The MTR105 instrument is designed to perform a number of tests that are typical for rotating machines.

These tests include

- Insulation resistance
- Voltage measurement
- Continuity
- DLRO, digital low resistance ohmmeter - 4 wire kelvin mΩ
- Motor direction of rotation test
- Capacitance
- Inductance
- Temperature

The MTR105 is powered by six AA alkaline primary cells. As an optional accessory, rechargeable NiMH AA cells can be used with an external power supply and adaptor to charge the batteries whilst in the instrument. Lithium primary (not Lithium Ion) cells can also be used.

For personal safety and to get the maximum benefit from this instrument, make sure that the safety warnings and instructions are read and understood before the instrument is used, see *Refer to 1. Safety Warnings on page 2*.

This user guide must be thoroughly read before attempting to operate the MTR105.

**NOTE :** This manual includes instructions for all MTR105 variants. Some facilities may not be available on your model of this equipment.

The MTR105 takes the test abilities of Megger's proven MIT400 test instruments adding: DLRO four wire tests, inductance and capacitance to provide a versatile motor tester, all packaged in a robust hand held instrument, which up to now has simply not been available.

In addition the MTR105 also incorporates temperature measurement and compensation (for Insulation Resistance and DLRO tests), direction of rotation plus supply phase rotation tests.

All these new test abilities go together to make the MTR105 a real world, versatile, hand held test instrument for rotating machinery.

The MTR105 also comes in an over-moulded case, providing increased protection, robustness and achieving an IP54 rating against moisture and dust ingress.

Refer to the image at *Refer to 2.6 Instrument Controls on page 7* for detail of the MTR105 layout.

For the safety of all personnel and to get the maximum benefit from this instrument, ensure the safety instructions of *Refer to 1. Safety Warnings on page 2* are read and thoroughly understood before the MTR105 is used.

Tests and connections detailed in this user guide are not exhaustive. Refer to the booklet **Guide to Motor Testing** (published by Megger) for further information about motor testing.

## 2.2 Applications

The MTR105 is an OFF LINE motor tester that can be used on small to medium sized rotating machines, typically up to 500 hp.

Typical applications include but are not limited to:

- New manufactured motor – test in production process.
- Refurbished/Repaired motor – test in repair workshop.
- Monitoring and maintenance of in service motors (off line) – workshop or in the field.

Where there is doubt about a particular application, refer to the booklet **Guide to Motor Testing**.

## 2.3 Features

- Guard Terminal to eliminate any surface leakage current.
- Detachable insulation resistance test leads with interchangeable clips and probes for different applications.
- Stores test results for up to 256 motors, which can be downloaded to a USB drive.
- Rotary dial control and full graphic display - simple and easy to use.
- Sealed to IP54, providing protection against moisture and dust ingress, including the battery and fuse compartments.
- Tough housing: A 'rubber over moulding' combines a tough shock absorbing outer protection with excellent grip, on a strong modified ABS housing, providing an almost indestructible case.
- Rechargeable batteries with mains charger kit option.

## 2.4 Company web site.

Occasionally an information bulletin may be issued via the Megger web site. This may be new accessories, new usage instructions or a software update. Please occasionally check on the Megger web site for anything applicable to your Megger instruments.

[www.megger.com](http://www.megger.com)

## 2.5 In the box

Unpack the carton contents carefully. There are important documents that you should read and keep for future reference. Please read the Safety Warning and User Guide before operating the instrument.

In the Box	MTR105 Product USB Contents
■ MTR105	■ User guide
■ Quick start and Safety warnings guide	■ Quick start and Safety warnings guide
■ Product warranty and registration	
■ Certificate of test	
■ Calibration certificate	
■ USB memory stick	
■ Grabber clip leadset	
■ Kelvin clip leadset	
■ Long reach test probe set CAT IV 600 V	
■ Temperature probe CAT III 600V	
■ Hanging hook and strap	
■ Soft pouch	
■ Batteries	



## 2.6 Instrument Controls

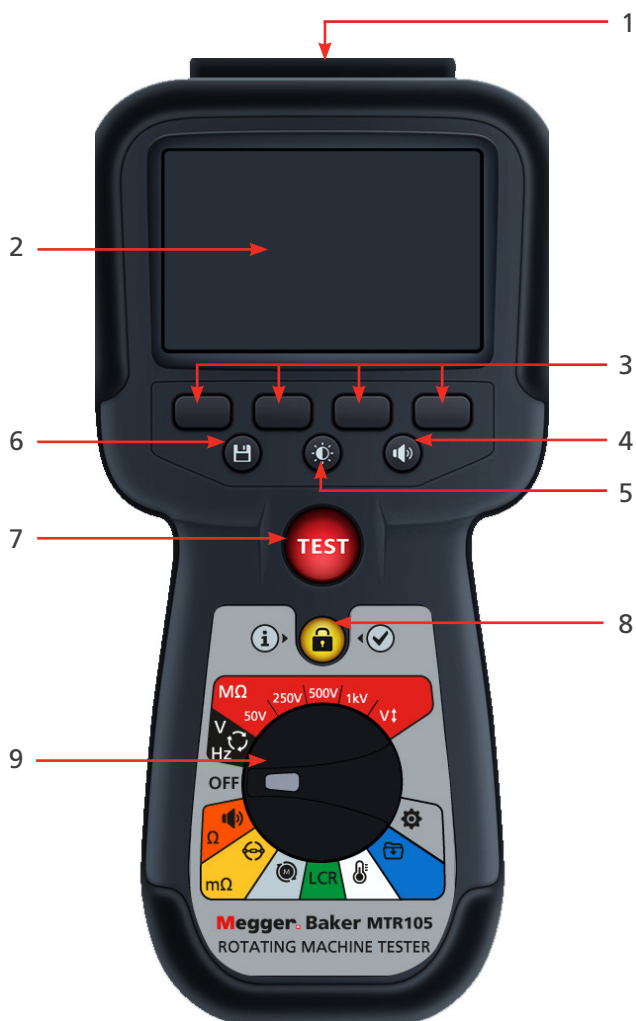

Item	Description	Item	Description
1	External electrical connections	6	Save
2	Display	7	Test
3	Soft keys (multifunction)	8	Information / Lock / OK
4	Buzzer control	9	Rotary selection switch
5	BACK-light control		

## 2.7 Instrument Display



Item	Description	Item	Description
1	Status / Mode	5	Soft key functions
2	Battery indicator	6	Secondary field
3	Primary field	7	Time
4	Status symbols		

## 2.8 Instrument Controls

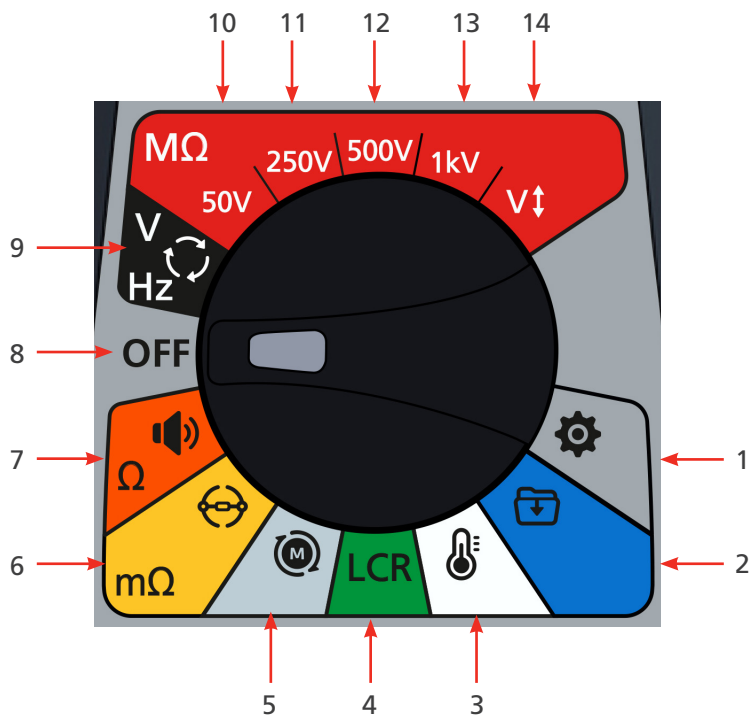

Item	Description	Item	Description
<b>Rotary switch positions</b>			
1	Settings (Grey)	8	Off (Grey)
2	Data management (Blue)	9	Voltmeter, 3 phase supply, direction of rotation and frequency (Black)
3	Temperature (White)	10	Insulation Resistance Test, 50 V (Red)
4	Inductance capacitance and resistance (Green)	11	Insulation Resistance Test, 250 V (Red)
5	Motor direction of rotation (Light grey)	12	Insulation Resistance Test, 500 V (Red)
6	Digital Low Resistance Ohmmeter (Yellow)	13	Insulation Resistance Test, 1 kV (Red)
7	Continuity and diode test (Orange)	14	Insulation Resistance Test, user selectable voltage (Red)

## 2.9 Instrument Connections and Leads

### 2.9.1 View on top of MTR105

Slider to front

Slider to back

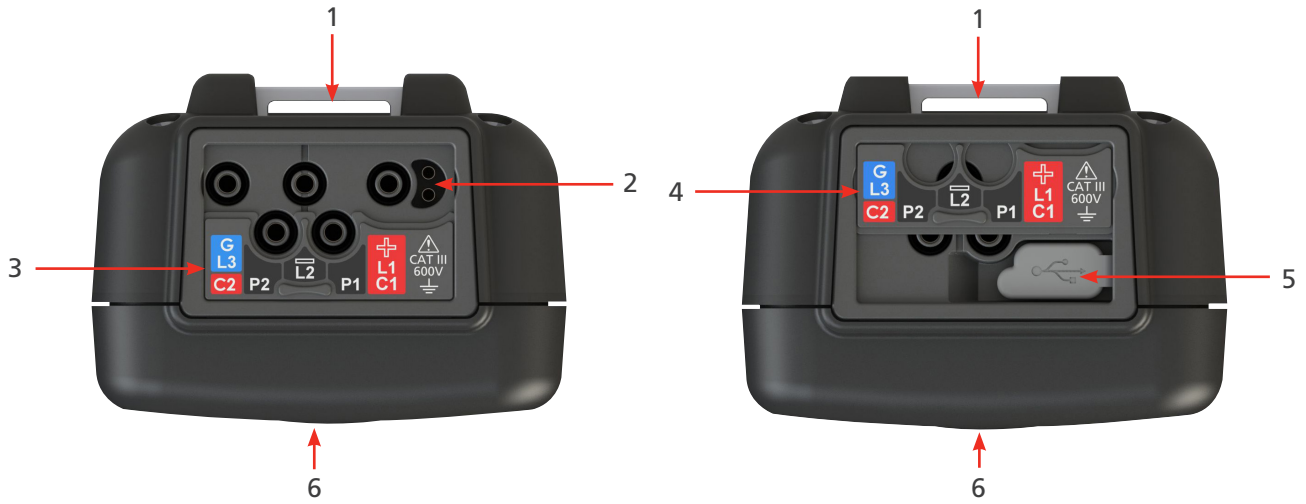

Item	Description	Item	Description
1	Rear attachment point for strap	4	Slider in rear position
2	Battery charger connection / switch probe	5	USB port
3	Slider in front position	6	Front

The external connections are all situated on top of the MTR105. A sliding cover is installed to prevent any other connection being made at the same time as the USB port. Connection to the USB port can only be made when the sliding cover is pushed completely to the back of the instrument.

For charging or connection to any test leads the sliding cover must be in the forward position.

The charger connection is designed so that no other lead can be connected while the battery is being charged in the instrument.



## 3. Instrument Set up

Before each use of the instrument, visually inspect the instrument case, test leads and connectors to confirm their condition is good, with no damaged or broken insulation

### 3.1 Warnings and exception conditions

There are two types of alerts that interrupt the standard process, they are the warnings for an external condition alert and the exception condition for an internal fault alert. The alert message is overlaid on the display screen with the fault message. The images below are examples illustrating the two types of alerts:

Alert for dangerous external fault.

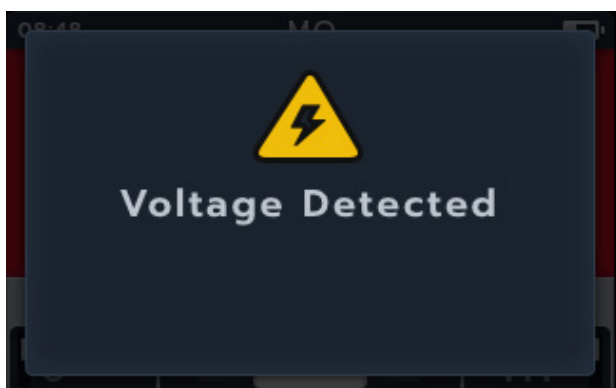

Alert for internal fault.

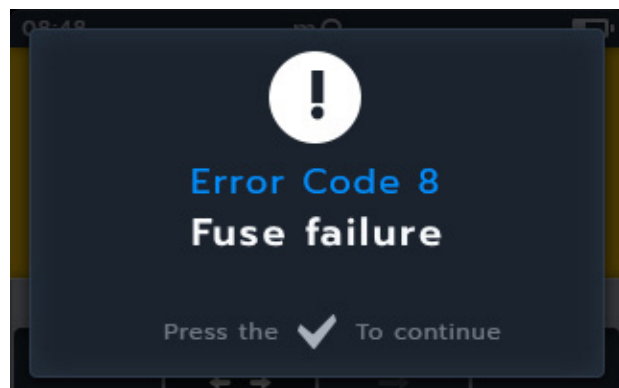

## 3.2 Power

### 3.2.1 First use

**NOTE :** Before the MTR105 can be turned on the battery isolation tab must be removed.

1. Remove the battery cover.
2. Pull the battery isolation tab clear of the battery cells.
3. Replace cover.

For further details on accessing the battery panel, Refer to 15.4 Battery and Fuse Replacement on page 83.

For initial date and time set up, Refer to 14.4.3 Date on page 78 and Refer to 14.4.7 Time on page 79.

**NOTE :** If the MTR should lose the date and time setting, (for example if the batteries have been replaced and the instrument has been without them for more than 3 minutes) the instrument will display a prompt screen when turned on to enter the date and time details - this can appear anytime after first set up.

### 3.2.2 Turn the instrument on and off

1. Turn the instrument ON by turning the rotary switch away from the OFF position to Activate the instrument.

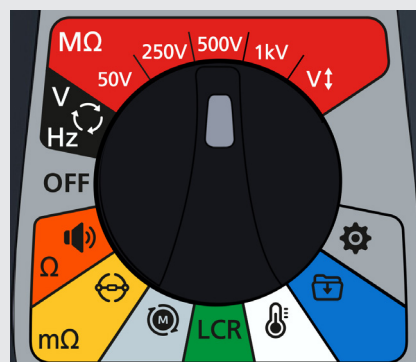

## Instrument Set up

2. Turn the instrument OFF by turning the rotary switch to the OFF position to deactivate the instrument.

**NOTE :** The MTR105 switches off after a period of inactivity, which is user adjustable, *Refer to 14. Settings on page 74.*

To start the instrument again rotate the mode switch to Off and then select a mode or press the TEST button to wake the instrument up.

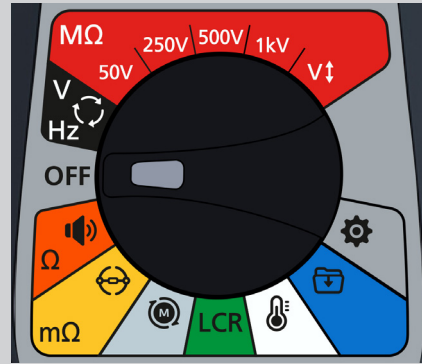

### 3.2.3 Power options

**CAUTION :** Do not attempt to recharge alkaline or Lithium cells, this action is a high potential fire hazard.

The MTR105 is powered by Internal batteries,

- These cells may be used:
  - 6 x LR6 1.5 V Alkaline (AA)
  - 6 x IEC HR6 1.2V NiMH
  - 6 x IEC FR6 1.5 V Lithium (LiFeS2).

The instrument charges using the DC adapter (NiMH cells only), which will work at voltages between 100 and 240 V AC. Charging will only occur if the battery type is set to NiMH.

**WARNING :** Charge NiMH cells only between 0 °C and +40 °C ambient.

The battery cell type is selected from the settings menu, *Refer to 14. Settings on page 74.* It will not charge Alkaline or LiFeS2 cells.

To charge the cells in the instrument, it has to have the mains charger kit plugged into the terminal connections. Testing or access the USB is not possible while the instrument is being charged.

See also *Refer to 16. Specifications on page 85*

### 3.3 Initial test set up

1. Turn on the MTR by rotating the range dial to the test type required.
2. Select the required test mode.

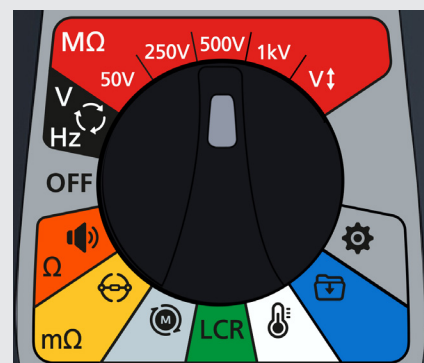

3. Connect the test leads to the MTR105.

3.1. Press the Information (i) button to view the lead set up diagram.

**NOTE :** When the diagram is displayed a test cannot be performed. Press Information (i) button to return to the test screen

This test can also be performed with just the red and the black lead.



4. Connect the test leads to the unit under test.





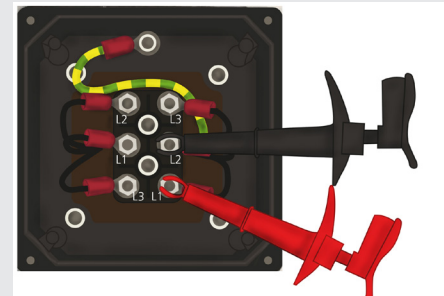

**NOTE :** The connection is for illustrative purposes only

When performing phase to phase measurements, the star or delta configuration has to be disconnected.



### 3.3.1 Test Lead connections

Switch the range dial to the required test mode and press the Information (i) button. Screen shows leads connected to terminal panel for the test.

Test Mode	Test sub-mode	Lead connections
 Insulation Resistance	Insulation resistance 3 Phase Polarisation index Timed Dielectric absorption ratio Variable voltage	
 Voltmeter	True rms AC DC	
 Voltmeter	Supply phase rotation	

## Instrument Set up



Continuity

Uni-directional  
Bi-directional  
Diode



DLRO

Single direction (auto and manual)  
Bi-direction (auto and manual)  
3 Phase



Motor rotation

Single direction (auto and manual)  
Bi-direction (auto and manual)  
3 Phase



LCR

Auto  
Capacitance  
Inductance  
3 Phase



Temperature  
measurement

Thermocouple temperature  
Manual temperature



### 3.4 Lockout Voltage

Before testing, the measurement board will carry out a short pre-test voltage check. If the lockout voltage is exceeded, the user will see an overlay menu showing the current voltage measured. The overlay will disappear if the voltage is lowered below the lockout voltage threshold.

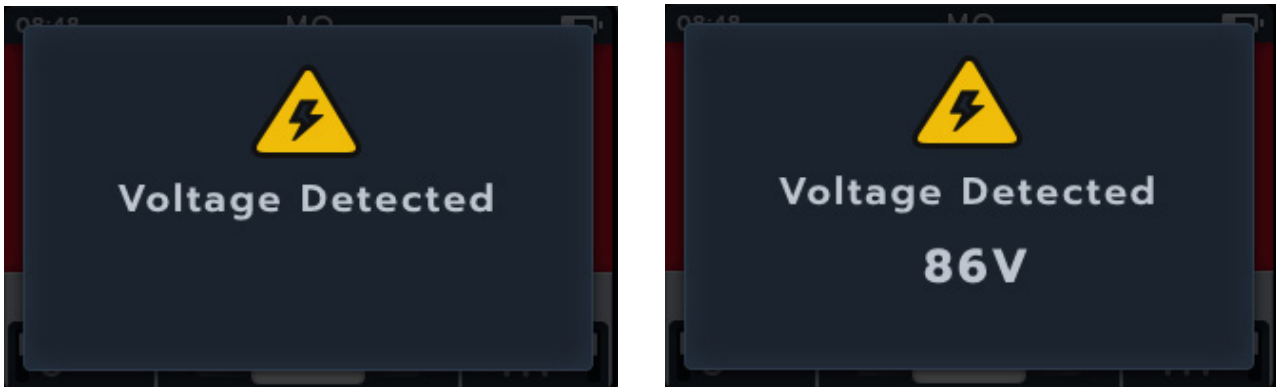

The lockout voltage is active on all test modes. It is hard-coded to Activate at 20 V. The only exception is the insulation resistance tests, where the lockout voltage can be set in the settings (as 20 V, 30 V, 50 V or 75 V).

### 3.5 Temperature compensation

Temperature compensation is available in a selection of test range sub-modes:

- Insulation resistance,
  - IR tests
  - 3 Phase test
  - Timed test
- DLRO
  - Uni-directional
  - Bi-directional
  - 3 phase

Temperature compensation is **OFF** by default.

#### 3.5.1 Example for using Temperature compensation

Turn the temperature compensation on and off by pressing soft key 4

**NOTE :** Before a test can be carried out with temperature compensation enabled, the temperature of the unit under test must be established.

For this procedure Refer to 14.2.4 Temperature compensation and motor class on page 76



If a temperature measurement hasn't been made, the right of the secondary field will show -- °C.

If a test is attempted with temperature compensation enabled the unit will display a Temperature missing pop-up window.

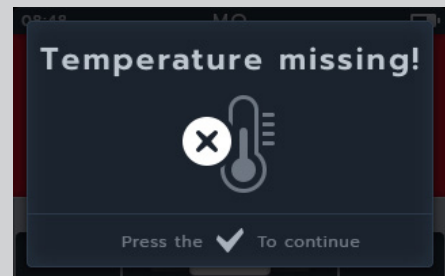

If the temperature reading is more than 30 minutes old, a red time stamp will be displayed in the secondary field above the temperature reading.



## 4. Insulation Resistance Tests

**WARNING :** Hazardous voltages are emitted throughout the insulation resistance tests. Do not touch the test leads while testing is in progress (after test button has been pressed). The warning triangle will flash on the display during these tests.

Insulation resistance tests can be carried out at the following settings 50 V, 250 V, 500 V, 1 kV and variable voltage (  ). These are all coloured red and are positioned across the top of the rotary switch.

The test method for each voltage setting is identical.

Variable voltage is user selectable, Refer to 14. Settings on page 74. The variable voltage setting is configurable between 10 V to 999 V.

### 4.1 Insulation test options

Icon	Description
IR:	Insulation resistance.
PI:	Polarization Index is the ratio between insulation resistance values recorded at 1 minute (assigned t1) and 10 minutes (assigned t2).
DAR:	Dielectric Absorption Ratio, it is the ratio between the insulation resistance values at 15 or 30 seconds (assigned t1) and at 60 second interval (assigned t2). i.e. after 30 seconds and 60 seconds. $DAR = 15 \text{ or } 30 \text{ (default) second value} / 60 \text{ second value}$ .
T(s):	Time IR = Selectable from 1 minute to 10 minutes, in 1 minute increments.
3P	3 Phase. To test insulation resistance phase to phase.

**WARNING :**  This warning triangle flashes when any voltage is being output in the insulation resistance test process.

### 4.2 Two Terminal and Guard

The MTR105 is fitted with a guard terminal. The guard terminal is used to conduct leakage currents away from the measured circuit to reduce errors.

The guard terminal is only used for insulation testing and as an additional connection in 3-phase testing. The lead is coloured blue.



The guard lead (G) is optional. When used, it should be connected to the guard conductor, screen, steel wire armoured conductor, or "user added" conductive wire or wrapper, such as foil.

For further information refer to **Guide to Motor Testing** published by Megger.

### 4.3 Automatic discharge

Following any insulation test, when the TEST button is released, the discharge loop begins to discharge the test piece. The automatic discharge loop will discharge the unit under test, removing any hazardous voltage introduced by the insulation test.

During the automatic discharge loop, the lightning symbol will flash and the falling voltage displayed on the left of the secondary field.

After the automatic discharge loop has finished, the secondary result is displayed in the secondary field again and the buzzer sounds for one second.

### 4.4 IR Buzzer settings

Set the buzzer to the preferred option before starting an Insulation resistance test.



Buzzer status is indicated at the bottom right hand corner of the primary field. The buzzer threshold is shown just above the status indicator.



The buzzer has 3 options and is set by pressing the fixed key.



The options are OFF (default), ON and Optical. Press and release the buzzer key until the desired function is reached.

Visual indicator	Description
	Buzzer off No indication given.
	Buzzer on - loud mode Sound icon will appear on screen and buzzer will sound.
	Buzzer on - optical / silent mode Eye icon will appear on screen.



When running an IR test, buzzer is active, but will not sound unless the limit is achieved or passed . When passed the audio will sound and the background will flash. A pass band is shown in the analogue scale and is highlighted in green.



The insulation threshold buzzer rate can be adjusted in the settings. Refer to 14.2.2 Insulation threshold on page 75

#### 4.5 Insulation Resistance test display

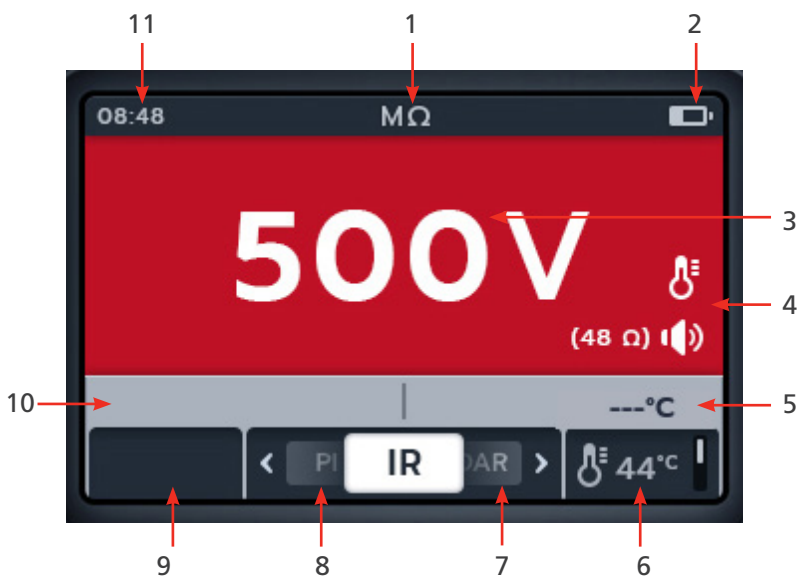

Item	Description	Item	Description
1	Insulation resistance mode	6	Soft key 4 - Temp compensation
2	Battery indicator	7	Soft key 3 - carousel sub mode right
3	Test measurement / results	8	Soft key 2 - carousel sub mode left
4	Buzzer setting details	9	Soft key 1 - not used
5	Secondary field - Temp compensation settings	10	Secondary field - voltage and amps
		11	Time

## 4.6 IR Test sequence

1. The display will show the selected voltage, in this case 500 V.
2. Press soft keys 2 and 3 to move the carousel left or right through sub-modes. IR is default, scroll through to 3P, PI, T(s) DAR.

**NOTE :** The full title text of the sub-mode will appear in the secondary field for a few seconds.



3. If required, press soft key 4 to toggle between temperature compensation on and off.

**NOTE :** This is available in IR, 3 Phase and Timed test mode. To adjust the temperature compensation, Refer to 14.2.4 Temperature compensation and motor class on page 76



4. If required, Turn the buzzer OFF, ON-loud or ON-visual only as required by pressing buzzer button. Refer to 4.4 IR Buzzer settings on page 18

**NOTE :** This is only available in IR, Timed and 3-Phase test mode.

To adjust the insulation threshold, Refer to 14. Settings on page 74



5. Start the test by pressing and holding down the TEST button. The buzzer will sound on test initiation.

- 5.1. To hold the test voltage, press the LOCK button while the TEST button is held. Once the lock symbol is displayed and the buzzer has sounded, the TEST button can be released. This test will continue until the TEST button or the LOCK button is pressed to stop the test. To enable this Refer to 14.2.3 Lock on page 75

**NOTE :** As the test starts the Soft Key Function field disappears, secondary and function fields drop to the bottom of the screen. Sub-mode initials separate the secondary fields.



6. During the tests,
  - Test results in the primary field show the IR value.
  - Status symbols will appear in the bottom right-hand corner of the primary field.
  - The secondary field shows the actual voltage and current.

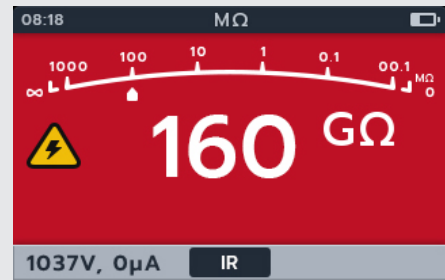

7. The test may be stopped at any time by pressing or releasing the TEST button again
8. When the test has completed the primary field displays the test results. The secondary field displays actual voltage output and the current measured.



9. To save the test result press the SAVE button. A message will inform you the data was saved and which asset ID it was saved to.
10. To restart the test press the TEST button again.

**NOTE :** To set up an asset ID Refer to 14. Settings on page 74



### 4.7 3 Phase (3P)

1. The display will show the selected voltage, in this case 500 V.
2. Press soft keys 2 and 3 to move the carousel left or right through sub-modes to 3P (3 phase).

**NOTE :** The full title text of the sub-mode will appear in the secondary field for a few seconds.

3. If required, press soft key 4 to toggle between temperature compensation on and off.

**NOTE :** This is available in IR, 3 Phase and Timed test mode. To adjust the temperature compensation, Refer to 14.2.4 Temperature compensation and motor class on page 76

4. To start the test press the TEST button.

A warning triangle will flash on screen.

**NOTE :** The test can be stopped at any time by pressing the TEST button.



## Insulation Resistance Tests

5. During the tests:

- The primary field displays a countdown time in seconds, warning triangle and completed phase to phase tests in the three phase sequence. Each phase icon will flash during each test.
- The secondary field displays actual voltage output and the current measured.

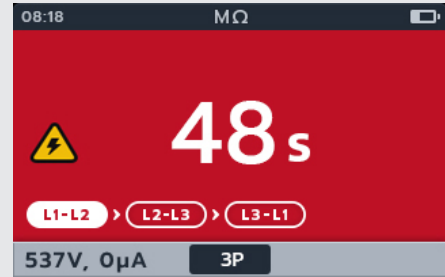

6. When the test has completed:

- The primary field displays the test results and also the actual voltage output and the current measured.
- The secondary field shows the % difference and Temperature compensation



7. The result can be saved by pressing the SAVE button. A message will inform you the data was saved and which asset ID it was saved to.

**NOTE :** If the test was stopped before completion, it cannot be saved.

8. To restart the test press the TEST button again.



## 4.8 Polarization Index (PI)

1. The display will show the selected voltage, in this case 500 V.
2. Press soft keys 2 and 3 to move the carousel left or right through sub-modes to PI (Polarization Index).

**NOTE :** The full title text of the sub-mode will appear in the secondary field for a few seconds.



3. To start the test press the TEST button.

The test will start and the clock will appear in the bottom left of the primary screen. The test will continue for 10 minutes. The clock will countdown the test. An interval result will appear after 1 minute.

A warning triangle will flash on screen.

**NOTE :** The test can be stopped at any time by pressing the TEST button.



4. During the tests,

- The primary field displays the test results.
- The secondary field displays actual voltage output and the current measured.

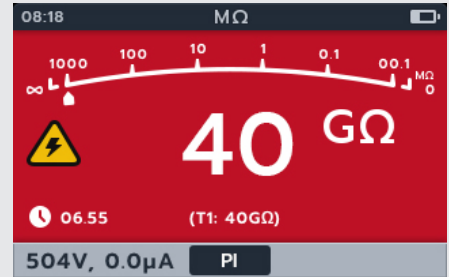

5. When the test has completed,

- The primary field displays the test results.



6. The result can be saved by pressing the SAVE button. A message will inform you the data was saved and which asset ID it was saved to.

**NOTE :** If the test was stopped before completion, it cannot be saved.

7. To restart the test pressing the TEST button again.



### 4.9 Timed (T(s)) Test

1. The display will show the selected voltage, in this case 500 V.
2. Press soft keys 2 and 3 to move the carousel left or right through sub-modes to T(s) (Timed Test).

**NOTE :** The full title text of the sub-mode will appear in the secondary field for a few seconds.

3. If required, press soft key 4 to toggle between temperature compensation on and off.

**NOTE :** This is available in IR, 3 Phase and Timed test mode. To adjust the temperature compensation, Refer to on page 20

4. To start the test press the TEST button.

The clock will appear in the bottom left corner of the primary field. The Timed test is user configurable and can run for 1,2,3,4,5,6,7,8,9, or 10 minutes Refer to 14.2.6 Timed Insulation on page 76

A warning triangle will flash on screen.

**NOTE :** The test can be stopped at any time by pressing the TEST button.

5. During the tests,

- The primary field displays the test results.
- The secondary field displays actual voltage output and the current measured.

6. When the test has completed,

- The primary field displays the test results.
- The secondary field displays actual voltage output and the current measured.

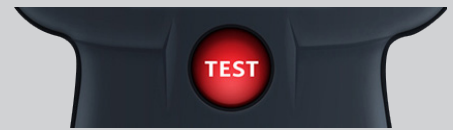

7. The result can be saved by pressing the SAVE button.  
A message will inform you the data was saved and which asset ID it was saved to.
8. To restart the test pressing the TEST button again.



#### 4.10 Dielectric Absorption Ratio (DAR)

1. The display will show the selected voltage, in this case 500 V.
2. Press soft keys 2 and 3 to move the carousel left or right through sub-modes to DAR (Dielectric Absorption Ratio).

**NOTE :** The full title text of the sub-mode will appear in the secondary field for a few seconds.



3. To start the test press the TEST button.

The clock will appear in the bottom left corner of the primary field as the DAR test runs for one minute.

A warning triangle will flash on screen.

**NOTE :** The test can be stopped at any time by pressing the TEST button.



4. During the tests,
  - The primary field displays the test results.
  - The secondary field displays actual voltage output and the current measured.



## Insulation Resistance Tests

5. When the test has completed,

- The primary field displays the test results.
- The secondary field displays actual voltage output and the current measured.

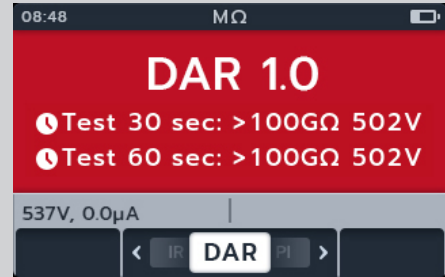

6. The result can be saved by pressing the SAVE button. A message will inform you the data was saved and which asset ID it was saved to.

**NOTE :** If the test was stopped before completion, it cannot be saved.

7. To restart the test pressing the TEST button again.





## 4.11 Variable voltage

1. Turn rotary switch to select variable voltage position.

**NOTE :** Set the voltage required under the variable voltage test setting. Refer to 14.2.7 Variable Voltage on page 76

2. The display will show the selected voltage, in this case 10 V.



3. Press soft keys 2 and 3 to move the carousel left or right through sub-modes. IR is default, scroll through to 3P, PI, T(s) DAR.



4. Run the chosen test as described in the previous sections.

## 5. Voltmeter

### 5.1 Voltage test display

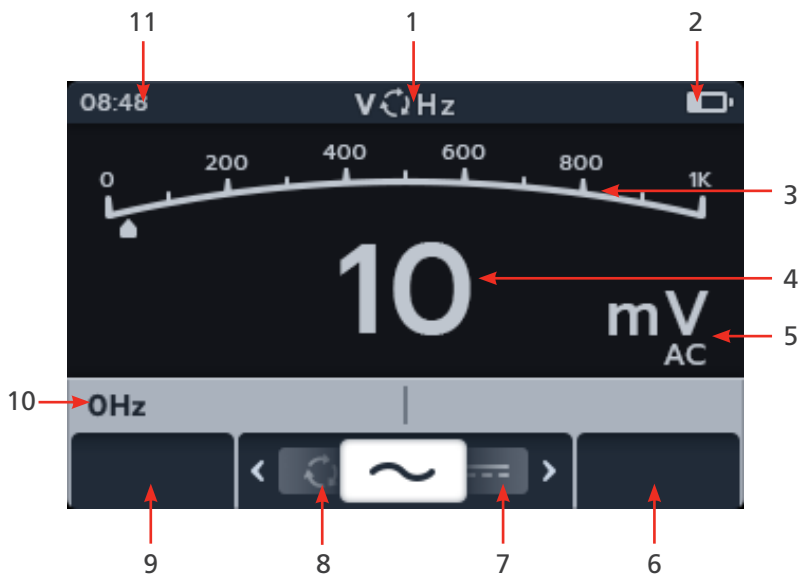

Item	Description	Item	Description
1	Voltage mode	6	Soft key 4 - unused
2	Battery indicator	7	Soft key 3 - carousel sub mode left
3	Analogue test measurement / results	8	Soft key 2 - carousel sub mode right
4	Digital test measurement / results	9	Soft key 1 - unused
5	Result units and setting	10	Secondary field
		11	Time

### 5.2 TRMS (True RMS)

Default is TRMS mode shows true RMS voltage. In TRMS mode the MTR105 will measure both AC and DC components of the supply voltage (AC+DC).

1. Turn rotary switch to select the Voltmeter (V) position.
2. The TRMS test starts automatically.
3. During the tests,
  - The primary field displays the measured voltage.
  - The secondary field displays frequency.



- The result can be saved by pressing the SAVE button. A message will inform you the data was saved and which asset ID it was saved to.



### 5.3 AC or DC

- Turn rotary switch to select the Voltmeter (V) position.
- Press soft keys 2 and 3 to move the carousel left or right through sub-modes to AC or DC as required.

**NOTE :** The full title text of the sub-mode will appear in the secondary field for a few seconds.



- The AC and DC tests start automatically.
- During the AC tests,
  - The primary field displays the measured voltage.
  - The secondary field displays frequency.
- During the DC tests,
  - The primary field displays the measured voltage.



- The result can be saved by pressing the SAVE button. A message will inform you the data was saved and which asset ID it was saved to.



## 5.4 Supply Phase Rotation

1. Turn rotary switch to select the Voltmeter (V) position.
2. Press soft keys 2 and 3 to move the carousel left or right through sub-modes to Supply Phase Rotation.

**NOTE :** The full title text of the sub-mode will appear in the secondary field for a few seconds.



3. This test starts automatically.

**NOTE :** Phase rotation result requires all phases connected before a result can be given.

4. During the tests,
  - The primary field displays the phase rotation sequence of the supply and constantly updating results for each phase sequence of the supply.
  - The secondary field displays frequency.



5. The result can be saved by pressing the SAVE button. A message will inform you the data was saved and which asset ID it was saved to.



## 6. Continuity

### 6.1 Continuity test display



Item	Description	Item	Description
1	Voltage mode	7	Soft key 4 - buzzer (Uni-direction only)
2	Battery indicator	8	Soft key 3 - carousel sub mode right
3	Analogue test measurement / results	9	Soft key 2 - carousel sub mode left
4	Digital test measurement / results	10	Soft key 1 - test current 20 mA / 200 mA
5	Buzzer setting when used	11	Secondary field - present current measured
6	Secondary field left - forward reverse measurement (Bi-direction only)	12	Timed reading
		13	Time

**NOTE :** Results of measurements can be adversely affected by impedances of additional operating circuits connected in parallel or by transient current.

**NOTE :**



Null symbol will show when the leads have been nulled to zero.



Crossed null symbol will show when the leads have not been nulled to zero

NULL the test leads by touching the two test probe ends. Press the TEST button until the NULL (symbol) appears on the screen. The ohmic value on the primary screen will read 0 Ω.

## Continuity

### 6.2 Uni-direction

1. Turn rotary switch to select the Continuity position.
2. If required, turn the buzzer off, on loud or on visual only as required by pressing buzzer button.

**NOTE :** This is only available in uni-direction mode.



3. To adjust the continuity buzzer threshold press soft key 4.

**NOTE :** The buzzer mode bypasses the continuity detection and voltage pretesting.



4. A new screen will open where the threshold can be adjusted pressing soft keys 2 and 3.
5. Press soft key 4 to save and return to the original screen.  
OR  
Press soft key 1 to cancel and return to the original screen.



6. Press soft keys 2 and 3 to move the carousel left or right through sub-modes to uni-direction

**NOTE :** The full title text of the sub-mode will appear in the secondary field for a few seconds.



- The test current can be toggled between 200 mA and 20 mA pressing soft key 1.



- NULL the test leads by touching the two test probe ends. Press the TEST button until the NULL (symbol) appears on the screen. The ohmic value on the primary screen will read 0 Ω.



- Connect the test leads to the unit under test.  
**NOTE :** The connection is for illustrative purposes only showing winding resistance across phase 1.

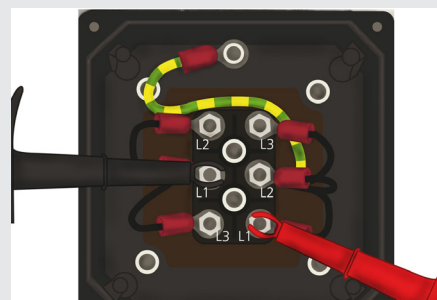

- This test starts automatically when the test leads are connected to the unit under test.
- During the tests,
  - The primary field displays the result of the true resistance of the unit under test.
  - The secondary field displays test current and the previous resistance value in Uni direction.



### 6.3 3 Phase Continuity

- Turn rotary switch to select the DLRO (mΩ) position.
- Press soft keys 2 and 3 to move the carousel left or right through sub-modes to 3 Phase.

**NOTE :** The full title text of the sub-mode will appear in the secondary field for a few seconds.

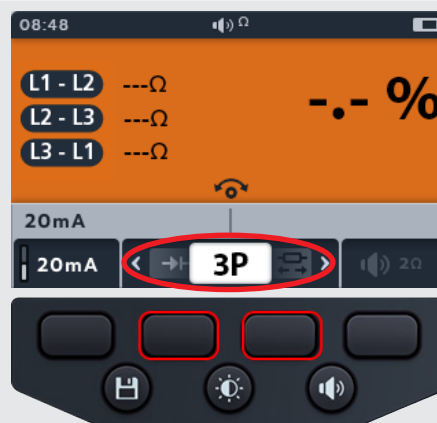

## Continuity

3. Connect the test leads to the unit under test.

**NOTE :** The connection is for illustrative purposes only showing winding resistance across phase 1.

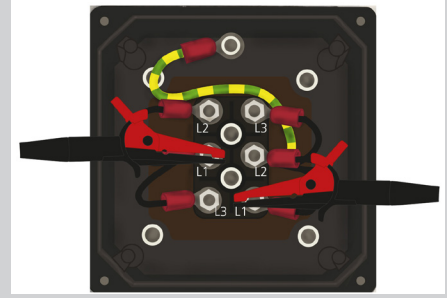

4. The test current can be toggled between 200 mA and 20 mA pressing soft key 1.

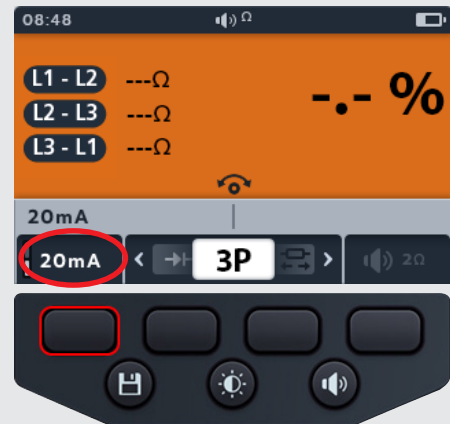

5. Press test



6. Press soft key 1 to assign reading to a phase (or press test before assigning to retest)

7. Move the probes to the next phase

8. Press test

**NOTE :** A result can be assigned to any phase and there is a possibility to change the phase if required.





9. Press soft key 2 to assign reading to a phase (or press test before assigning to retest)
10. Move the probes to the next phase
11. Press test



12. Press soft key 3 to assign reading to a phase

**NOTE :** The percentage difference is calculated from the largest deviation between test readings



13. When the test has completed,

- The primary field displays the result for percentage difference.

**NOTE :** The percentage difference is calculated from the largest deviation between test readings



14. The result can be saved by pressing the SAVE button. A message will inform you the data was saved and which asset ID it was saved to.

**NOTE :** Results can be saved at any point during the 3 Phase test sequence. One, two or three test values can be saved.

15. To restart the test, press soft key 4 then repeat the steps for 3 Phase testing.



## 6.4 Bi-direction

1. Turn rotary switch to select the Continuity position.
2. Press soft keys 2 and 3 to move the carousel left or right through sub-modes to bi-direction

**NOTE :** The full title text of the sub-mode will appear in the secondary field for a few seconds.



3. The test current can be toggled between 200 mA and 20 mA pressing soft key 1.



4. NULL the test leads by touching the two test probe ends. Press the TEST button until the NULL (symbol) appears on the screen. The ohmic value on the primary screen will read 0 Ω.



5. Connect the test leads to the unit under test.

**NOTE :** The connection is for illustrative purposes only showing winding resistance across phase 1.

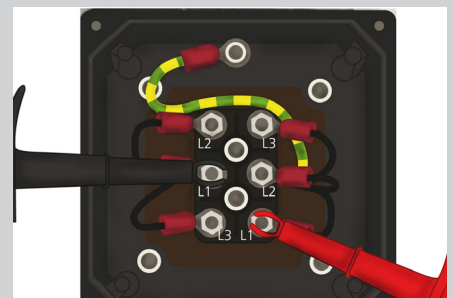

6. This test starts automatically.
7. During the tests,
  - The primary field displays the result of the true resistance of the unit under test
  - The secondary field displays the test current and the resistance values in both directions - highest value shown in Primary.
  - The test in bi-direction mode runs continually



## 6.5 Diode test

1. Turn rotary switch to select the Continuity position.
2. Press soft keys 2 and 3 to move the carousel left or right through sub-modes to Diode test.

**NOTE :** The full title text of the sub-mode will appear in the secondary field for a few seconds.



3. This test starts automatically.
4. During the tests, the primary field displays the voltage drop as it is measured.



- A good forward-biased diode displays a voltage drop ranging from 0.5 to 0.8 V for the most commonly used silicon diodes. Some germanium diodes have a voltage drop ranging from 0.2 to 0.3 V. The voltage drop is also dependent on the test current.
- The meter displays O/C when a good diode is reverse-biased. The O/C reading indicates the diode is functioning as an open switch.
- A bad (open circuit) diode does not allow current to flow in either direction. The meter will display O/C in both directions when the diode is opened.
- A short circuited diode has zero voltage drop reading in both directions.
- If a voltage between 0 V and 3 V is detected, the buzzer will sound and background flash /or background flash depending on what buzzer mode is activated.
- If a voltage above 3 V is detected, the buzzer will NOT sound and the background will not flash, the display will show "OL".

## Continuity



**NOTE :** The user is responsible for connecting test probes across the diode under test. There is no information displayed in the secondary field at this point. The only information to display is the diode drop voltage if the instrument senses a voltage across the device. If no current flows the main display will show "O/C".

## 7. DLRO Digital Low Resistance Ohmmeter

### 7.1 DLRO display

#### 7.1.1 Uni/Bi-direction test display

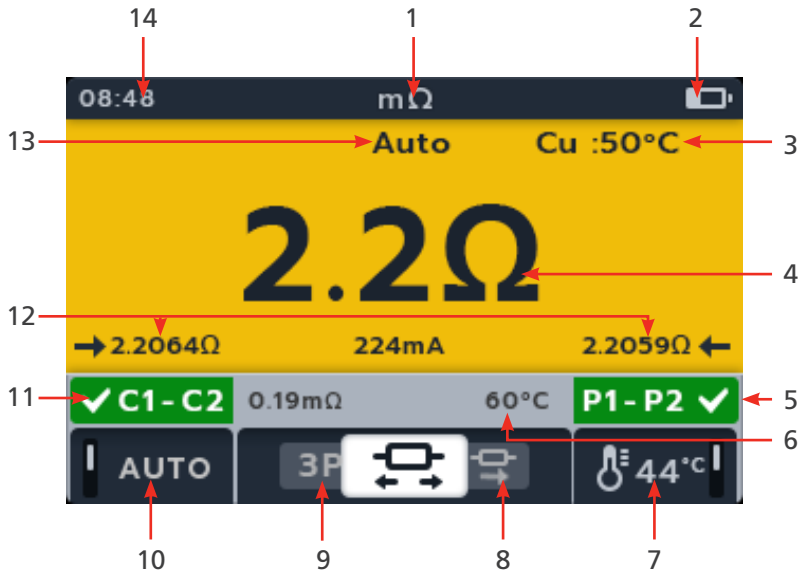

Item	Description	Item	Description
1	DLRO mode	8	Soft key 3 - carousel sub mode right
2	Battery indicator	9	Soft key 2 - carousel sub mode left
3	Cable material (temperature compensation)	10	Soft key 1 - Auto test on/off
4	Digital test measurement / results	11	Secondary field - C1-C2 connection status
5	Secondary field left - P1-P2 connection status	12	Forward reverse readings (Bi directional only)
6	Secondary field left - previous temperature compensation measurement	13	Auto on
7	Soft key 4 - Temperature compensation	14	Time

### 7.1.2 3-Phase test display

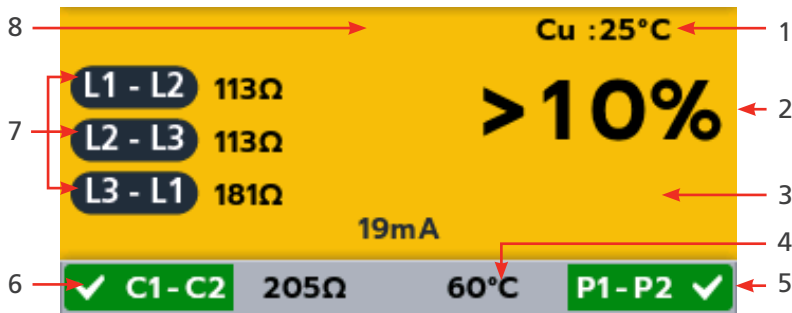

Item	Description	Item	Description
1	Cable material (temperature compensation)	5	Secondary field - P1-P2 connection status
2	Digital test measurement / results	6	Secondary field - C1-C2 connection status
3	Percentage difference	7	3 Phase readings
4	Secondary field left - last recorded temperature of test subject	8	Auto on

### 7.2 Manual single direction test

1. Turn rotary switch to select the DLRO (mΩ) position.
2. Press soft keys 2 and 3 to move the carousel left or right through sub-modes to uni-directional.

**NOTE :** The full title text of the sub-mode will appear in the secondary field for a few seconds.



3. Connect the test leads to the unit under test.

**NOTE :** The connection is for illustrative purposes only showing winding resistance across phase 1.

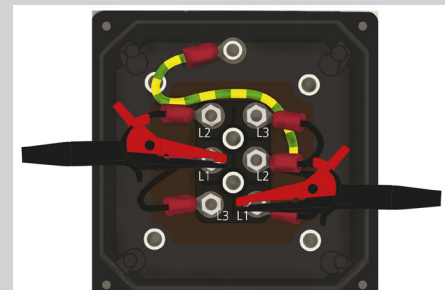

4. If there is a continuity reading detected for C and P connections the secondary fields will display with a tick and background will be green.

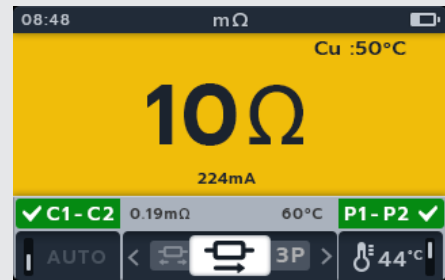

5. To start the test press the TEST button.  
6. The test runs for a few seconds, then automatically stops.



7. During the tests,
- The primary field displays the result with the actual current being delivered. As the resistance gets higher the current will get lower.
  - The secondary field displays the continuity on the Current (C1-C2) and potential (P1-P2) circuits.

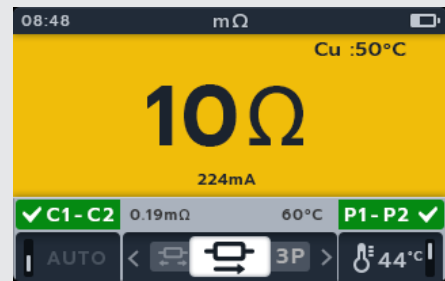

8. The result can be saved by pressing the SAVE button.  
A message will inform you the data was saved and which asset ID it was saved to.  
9. To restart the test, press the TEST button again.



### 7.3 Auto Single direction test

1. Turn rotary switch to select the DLRO (mΩ) position.
2. Press soft keys 2 and 3 to move the carousel left or right through sub-modes to uni-directional

**NOTE :** The full title text of the sub-mode will appear in the secondary field for a few seconds.



3. Connect the test leads to the unit under test.

**NOTE :** The connection is for illustrative purposes only showing winding resistance across phase 1.

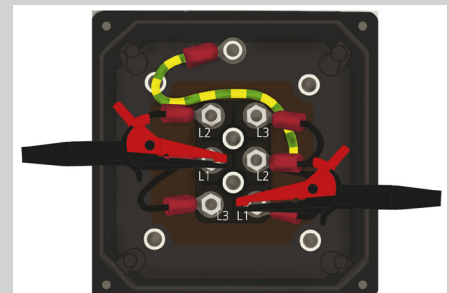

4. Press soft key 1 to enable auto mode.
5. If there is a continuity reading detected for C and P connections the secondary fields will display with a tick and background will be green.

If all the leads are connected correctly, test will start immediately.

6. The test runs for a few seconds then automatically stop



7. During the tests,
  - The primary field displays the result with the actual current being delivered. As the resistance gets higher the current will get lower.
  - The secondary field displays the continuity on the Current (C1-C2) and potential (P1-P2) circuits.





8. The result can be saved by pressing the SAVE button. A message will inform you the data was saved and which asset ID it was saved to.
9. To restart the test, re-connect to a new test piece and the test will start automatically.



## 7.4 Manual bi-direction test

1. Turn rotary switch to select the DLRO (mΩ) position.
2. Press soft keys 2 and 3 to move the carousel left or right through sub-modes bi-directional.

**NOTE :** The full title text of the sub-mode will appear in the secondary field for a few seconds.



3. Connect the test leads to the unit under test.

**NOTE :** The connection is for illustrative purposes only showing winding resistance across phase 1.

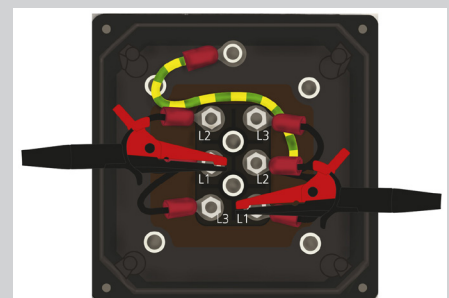

4. If there is a continuity reading detected for C and P connections the secondary fields will display with a tick and background will be green.



## DLRO Digital Low Resistance Ohmmeter

5. To start the test press the TEST button.
6. The test runs for a few seconds, then automatically stop.



7. During the tests,
  - The primary field displays a rotating circle to show a test is underway.
  - The secondary field displays the continuity on the Current (C1-C2) and potential (P1-P2) circuits.



8. When the test has completed,
  - The primary field displays the result for current and resistance in each direction and an average of the two.
  - The secondary field displays the continuity on the Current (C1-C2) and potential (P1-P2) circuits.



9. The result can be saved by pressing the SAVE button. A message will inform you the data was saved and which asset ID it was saved to.

10. To restart the test, press the TEST button again.



## 7.5 Auto Bi direction test

1. Turn rotary switch to select the DLRO (mΩ) position.
2. Press soft keys 2 and 3 to move the carousel left or right through sub-modes to bi-directional.

**NOTE :** The full title text of the sub-mode will appear in the secondary field for a few seconds.



3. Connect the test leads to the unit under test.

**NOTE :** The connection is for illustrative purposes only showing winding resistance across phase 1.

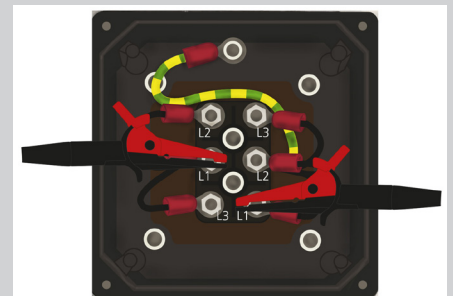

4. Press soft key 1 to enable auto mode.
5. If there is a continuity reading detected for C and P connections the secondary fields will display with a tick and background will be green.
6. If all the leads are connected correctly, test will start immediately, runs for a few seconds and then automatically stop.



7. During the tests,
  - The primary field displays a rotating circle to show a test is underway
  - The secondary field displays the continuity on the Current (C1-C2) and potential (P1-P2) circuits

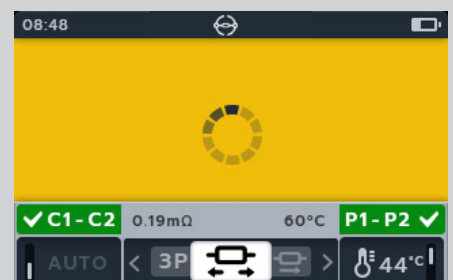

8. When the test has completed,
  - The primary field displays the result for current and resistance in each direction and an average of the two.
  - The secondary field displays the continuity on the Current (C1-C2) and potential (P1-P2) circuits.

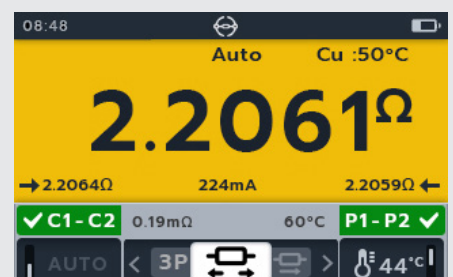

## DLRO Digital Low Resistance Ohmmeter

9. The result can be saved by pressing the SAVE button. A message will inform you the data was saved and which asset ID it was saved to.
10. To restart the test, re-connect to a new test piece and the test will start automatically.



## 7.6 DLRO 3 Phase

1. Turn rotary switch to select the DLRO (mΩ) position.
2. Press soft keys 2 and 3 to move the carousel left or right through sub-modes to 3 Phase.

**NOTE :** The full title text of the sub-mode will appear in the secondary field for a few seconds.



3. Connect the test leads to the unit under test.

**NOTE :** The connection is for illustrative purposes only showing winding resistance across phase 1.

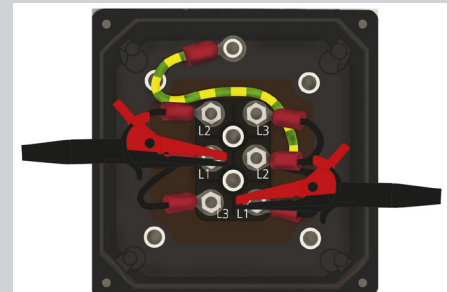

4. Press soft key 1 to enable auto mode.
5. If there is a continuity reading detected for C and P connections the secondary fields will display with a tick and background will be green.
6. If all the leads are connected correctly, test will start immediately, runs for a few seconds and then automatically stop.



7. Press test



8. Press soft key 1 to assign reading to a phase (or press test before assigning to retest)

9. Move the probes to the next phase

10. Press test

**NOTE :** A result can be assigned to any phase and there is a possibility to change the phase if required.

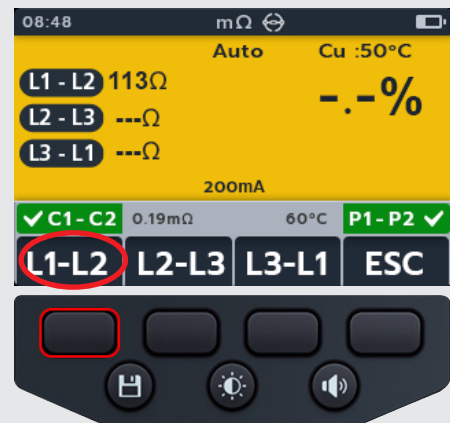

11. Press soft key 2 to assign reading to a phase (or press test before assigning to retest)

12. Move the probes to the next phase

13. Press test



14. Press soft key 3 to assign reading to a phase

**NOTE :** The percentage difference is calculated from the largest deviation between test readings



## DLRO Digital Low Resistance Ohmmeter

15. When the test has completed,

- The primary field displays the result for percentage difference.

**NOTE :** The percentage difference is calculated from the largest deviation between test readings



16. The result can be saved by pressing the SAVE button.

A message will inform you the data was saved and which asset ID it was saved to.

**NOTE :** Results can be saved at any point during the 3 Phase test sequence. One, two or three test values can be saved.

17. To restart the test, press soft key 4 then repeat the steps for 3 Phase testing.



## 7.7 Test failure

### 7.7.1 Lost connection

Should the connection be lost during the test the MTR105 will notify the user. The user can re-make the connection then restart the test after a few seconds by pressing the test button or by reconnecting to a test piece.

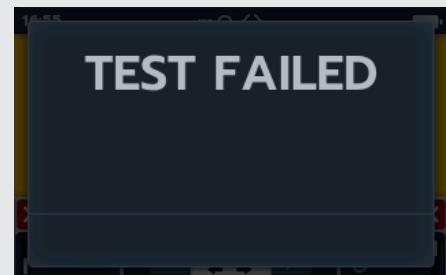

## 8. Direction of Motor Rotation

1. Turn on the MTR by rotating the range dial to the test type required.
2. Turn rotary switch to select direction of motor rotation position.

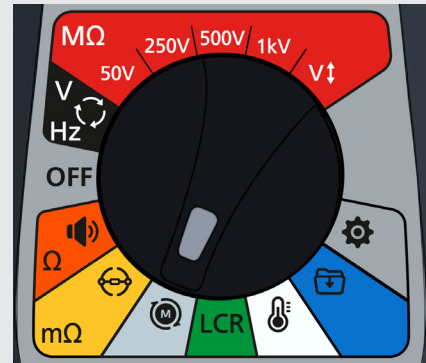

3. Connect the test leads to the MTR105.
  - 3.1. Press the Information (i) button to view the lead set up diagram.
    - Connect L1 to phase 1
    - Connect L2 to phase 2
    - Connect L3 to phase 3



**CAUTION :** Please ensure the motor is configured for star (Y) or delta configuration before performing the test.

**NOTE :** When the diagram is displayed a test cannot be performed. Press Information (i) button to return to the test screen.

4. Connect the test leads to the unit under test.

**NOTE :** The connection is for illustrative purposes only.

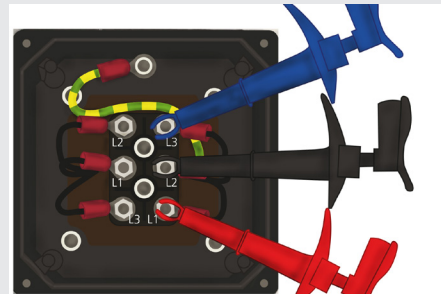

5. Rotate the motor in one direction. Check if display matches L1 L2 L3 correct phases of rotation.

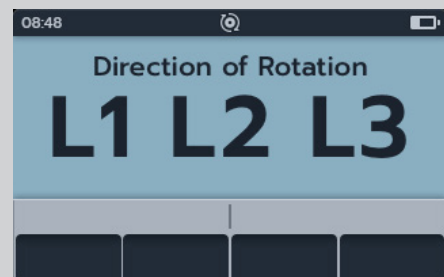

6. Rotate the motor in opposite direction. Check if display matches L3 L2 L1 correct phases of rotation

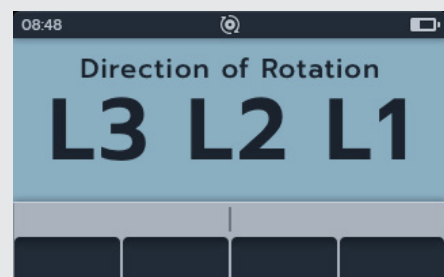

## 9. Inductance (L); Capacitance (C); Resistance (R) (LCR)

### 9.1 LCR test display

#### 9.1.1 Capacitance, Inductance, Auto test display

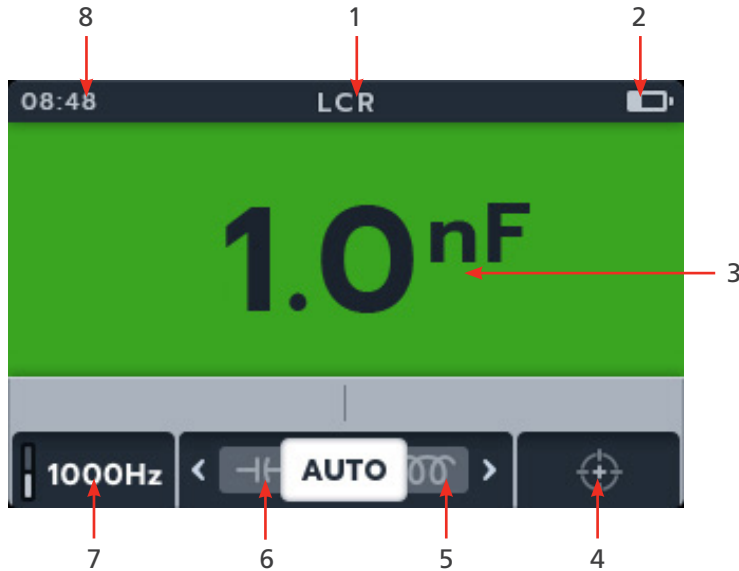

Item	Description	Item	Description
1	LCR mode	5	Soft key 3 - Carousel sub mode right
2	Battery indicator	6	Soft key 2 - Carousel sub mode left
3	Digital test measurement / results	7	Soft key 1 - Hertz settings
4	Soft key 4 - Inductance calibration	8	Time

#### 9.1.2 3-Phase test display

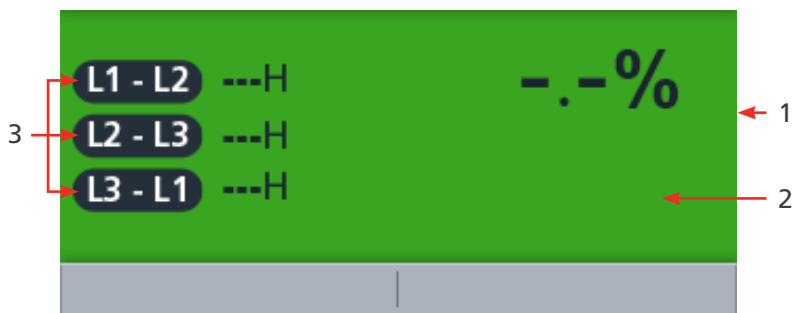

Item	Description	Item	Description
1	Digital test measurement / results	3	3 Phase readings
2	Percentage difference		

**NOTE :** Results of measurements can be adversely affected by impedances of additional operating circuits connected in parallel or by transient current.



## 9.2 Auto

1. Turn rotary switch to select the LCR position.
2. Connect the test leads to the unit under test.

**NOTE :** The connection is for illustrative purposes only showing connection across phase 1.

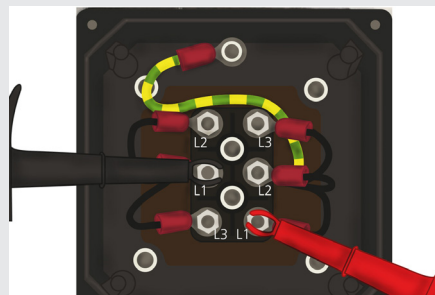

3. Press soft keys 2 and 3 to move the carousel left or right through sub-modes to auto capacitance / inductance test.

**NOTE :** The full title text of the sub-mode will appear in the secondary field for a few seconds.



4. Press soft keys 1 to toggle between 120 Hz and 1000 Hz.



5. To start the test press the TEST button.

The MTR105 determines if the load is inductive, capacitive or resistive automatically.



6. During the tests,

- The primary field displays the result for the reactive component. (This could be capacitance, inductance or resistance).
- The secondary field displays the frequency.



### 9.3 Capacitance or inductance

1. Turn rotary switch to select the LCR position.
2. Press soft keys 2 and 3 to move the carousel left or right through sub-modes to capacitance or inductance test.

**NOTE :** The full title text of the sub-mode will appear in the secondary field for a few seconds.

**NOTE :** (—|—) Capacitance

**NOTE :** (∞) Inductance



3. Connect the test leads to the unit under test.

**NOTE :** The connection is for illustrative purposes only showing connections across phase 1.

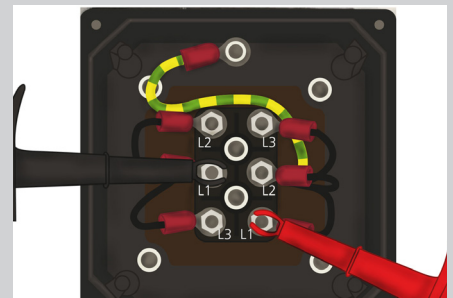

4. Press soft keys 1 to toggle between 120 Hz and 1000 Hz.



5. To start the test press the TEST button.

The MTR105 determines if the load is inductive, capacitive or resistive automatically.

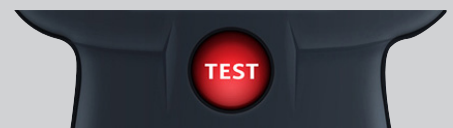

6. During the tests,
  - The primary field displays a rotating circle to show a test is underway.
  - The secondary field displays the frequency.

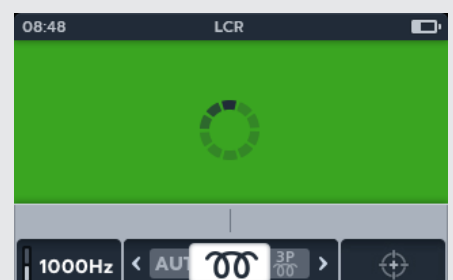

7. During the tests,

- The primary field displays the result for the reactive component. (This could be capacitance, inductance or resistance).
- The secondary field displays the frequency.



## 9.4 LCR 3 Phase

1. Turn rotary switch to select the LCR position.
2. Press soft keys 2 and 3 to move the carousel left or right through sub-modes to 3 Phase.

**NOTE :** The full title text of the sub-mode will appear in the secondary field for a few seconds.



3. Connect the test leads to the unit under test.

**NOTE :** The connection is for illustrative purposes only showing winding resistance across phase 1.

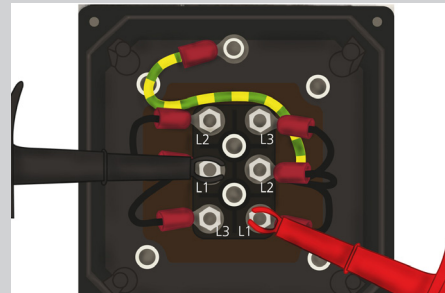

4. Press soft keys 1 to toggle between 120 Hz and 1000 Hz.



## Inductance (L); Capacitance (C); Resistance (R) (LCR)

5. Press test

**NOTE :** Press soft Key 4 ESC to exit 3 Phase testing at any point



6. Press soft key 1 to assign reading to a phase (or press test before assigning to retest)

7. Move the probes to the next phase

8. Press test

**NOTE :** A result can be assigned to any phase and there is a possibility to change the phase if required.



9. Press soft key 2 to assign reading to a phase (or press test before assigning to retest)

10. Move the probes to the next phase

11. Press test



12. Press soft key 3 to assign reading to a phase



13. When the test has completed,

- The primary field displays the result for percentage difference.

**NOTE :** The percentage difference is calculated from the largest deviation between test readings



14. The result can be saved by pressing the SAVE button.

A message will inform you the data was saved and which asset ID it was saved to.

**NOTE :** Results can be saved at any point during the 3 Phase test sequence. One, two or three test values can be saved.

15. To restart the test, press soft key 4 then repeat the steps for 3 Phase testing.

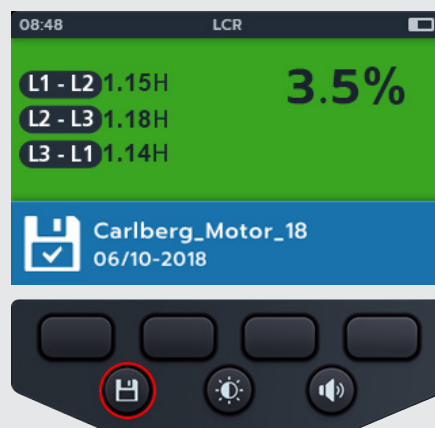

## 9.5 LCR Calibration

**NOTE :** For full MTR105 re-calibration procedure Refer to 18. Calibration, Repair and Warranty on page 89.

1. Inductance calibration can be accessed from any sub-mode within the LCR family by pressing soft key 4.



2. The open circuit calibration screen appears. The icon on soft key 4 will flash
3. With the leads connected to the instrument but the circuit kept open (separated).
4. Press soft key 4 again to begin calibration. The icon will appear solid
5. Calibration will run for about 14 seconds (progress animation will show).



6. After calibration the confirmation screen will appear.
7. Continue by pressing the tick button (✓) or Soft key 4.

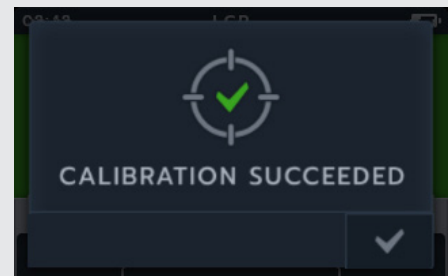

8. The closed circuit calibration screen appears.
9. With the leads connected to the instrument, close the circuit (short circuit)
10. Press soft key 4 to begin calibration.
11. Calibration will run for about 14 seconds (progress animation will show).



12. After calibration the confirmation screen will appear.
13. Press the tick button (✓) or soft key 4 to return to the last LCR test mode.

The MTR105 has been successfully recalibrated and is ready for use. The new calibration will be stored.

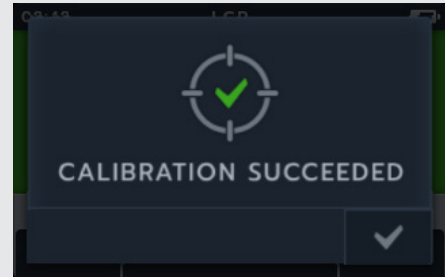

14. If calibration fails, 2 options appear:
  - Press soft key 1 to go bACK
  - or
  - Press the tick button (✓) or soft key 4 to try again

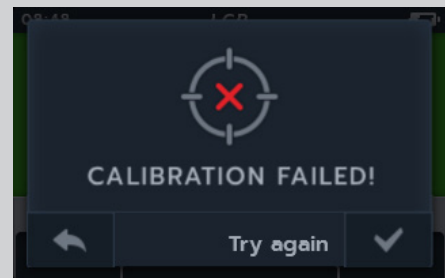

## 10. Temperature measurement

Thermocouple connected, type “T” is set as default, the MTR105 can also be configured for “J” and “K” type thermocouples.

Before an insulation resistance test can be carried out with temperature compensation enabled a temperature measurement must be carried out to establish the temperature of the unit under test.

1. Temperature measurement screen will display O/C when the thermocouple is not detected and there is not a previous temperature measurement reordered.



2. Two options are displayed:
  - 2.1. Connect the thermocouple for an accurate temperature measurement.
  - 2.2. Press soft key 4 for a manual temperature measurement.

### 10.1 Thermocouple temperature measurement

1. Turn rotary switch to select the Thermometer position.
2. Connect the thermocouple test leads to the MTR105.
  - 2.1. Press the Information (i) button to view the lead set up diagram.

**NOTE :** When the diagram is displayed a test cannot be performed. Press Information (i) button to return to the test screen.

**NOTE :** The thermocouples are sensitive to polarity.



3. Press soft keys 2 and 3 to move the carousel left or right to choose thermocouple type T, K or J.

A thermocouple symbol appears in the bottom left of the primary screen, alongside the type of thermocouple selected.





- Press soft key 1 to toggle between °C (Centigrade) or °F (Fahrenheit).

**NOTE :** This will change the temperature units of measure for all temperature reading within the MTR test and measurement results.



- Place the thermocouple against the test piece and allow the thermocouple to rise to a stable temperature.
- The unit starts measuring the temperature as soon as it detects the probe is connected.

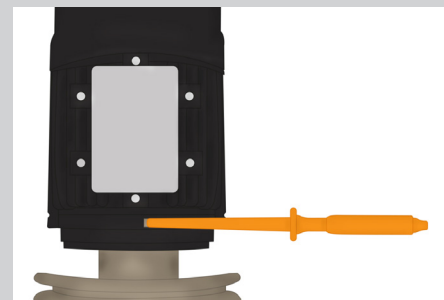

- During the test the primary field displays the measured temperature.

**NOTE :** If the thermocouple is not connected or is damaged the primary field will display "O/C"



- The result can be saved by pressing the SAVE button. A message will inform you the data was saved and which asset ID it was saved to.



## 10.2 Manual Temperature measurement

1. Turn rotary switch to select the Thermometer position.

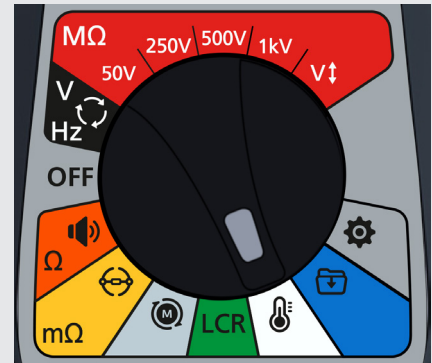

2. Press soft key 4.



3. Press soft keys 2 and 3 to select a positive or negative temperature.
4. Press soft key 4 to confirm or soft key 1 to cancel.



5. Press soft key 2 and 3 to scroll through the digits.
6. Press soft key 4 to accept the first digit and move to the next.
7. Press soft key 2 and 3 to scroll through the digits.
8. Press soft key 4 to accept the second digit and move to the next.
9. Press soft key 2 and 3 to scroll through the digits.
10. Press soft key 4 to accept the third digit and move to the next.
11. Press soft key 2 and 3 to scroll through the digits.
12. Press soft key 4 to accept the temperature value.
13. Press soft key 1 to cancel and return to the previous menu at any point.

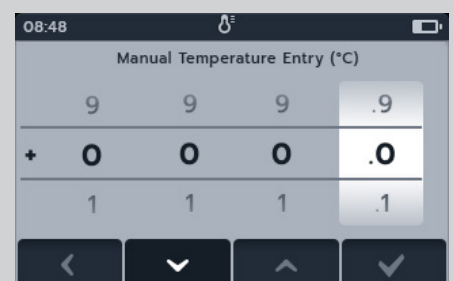

14. The new temperature will be displayed.  
The result can be saved by pressing the SAVE button.  
A message will inform you the data was saved and which asset ID it was saved to.



## 11. Data management

Use data management mode to view saved test results and transfer saved test results to USB drive or PC.

### 11.1 Creating a new asset ID

1. Turn rotary switch to select the data management position.

The primary field shows list of Assets stored on the MTR.

The secondary field shows the amount of entries, the total storage available are shown in the left hand field and the number of entries under the selected asset are shown in the right hand field.

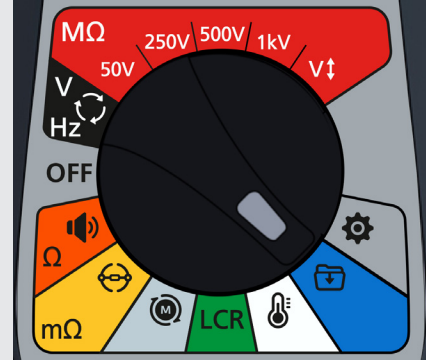

2. Press soft keys 2 and 3 to scroll up and down through the asset list.

**NOTE :** Assets are save and sorted in an ascending order. The chosen asset for saved information is held at the top of the display while scrolling through the list.



3. Press soft key 1 to type in a new asset. The relevant language keyboard screen will appear.



4. Press soft keys 1, 2, 3 and 4 to navigate the keyboard
5. Press the tick button (✓) to type the selected character into the title space in secondary field.
  - Upper case can be selected via the shift key.
  - Select the 123 key for numbers and other symbols.
6. Press the save button to create the asset  
or  
To cancel the entry select back character (←) and press the tick button (✓).



## 11.2 Using an existing asset ID

1. Turn rotary switch to select the data management position.

The primary field shows list of assets stored on the MTR.

The secondary field shows the amount of entries, the total storage available are shown in the left hand field and the number of entries under the selected asset are shown in the right hand field.

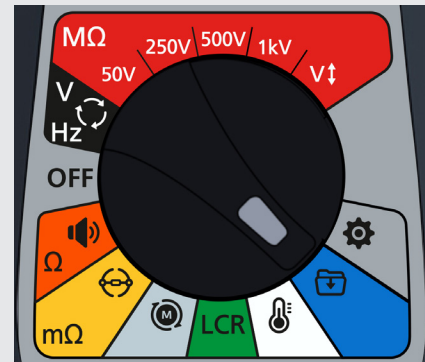

2. Press soft keys 2 and 3 to scroll up and down through the asset list



3. Press the SAVE button to assign the next measurements to this asset.



### 11.3 Deleting an asset

1. Turn rotary switch to select the data management position.

The primary field shows list of Assets stored on the MTR.

The secondary field shows the amount of entries, the total storage available are shown in the left hand field and the number of entries under the selected asset are shown in the right hand field.

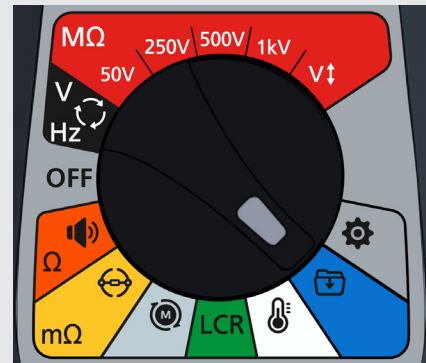

2. Press soft keys 2 and 3 to scroll up and down through the asset list.



3. Press soft key 4 to delete chosen asset and all its entries.



4. Press soft key 4 to confirm  
or  
Soft key 1 to cancel.



## 11.4 Deleting items from within an asset

1. Turn rotary switch to select the data management position.

The primary field shows list of Assets stored on the MTR.

The secondary field shows the amount of entries, the total storage available are shown in the left hand field and the number of entries under the selected asset are shown in the right hand field.

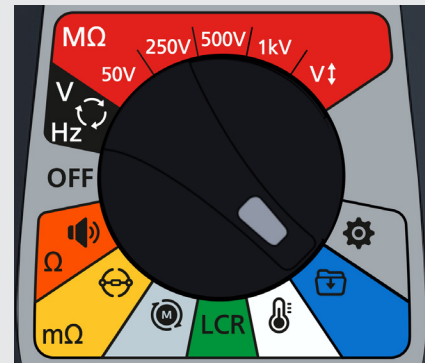

2. Press soft keys 2 and 3 to scroll up and down through the asset list.



3. Press the tick button (✓) to open the chosen asset and all its entries.



4. Press soft keys 2 and 3 to scroll up and down through the list.
5. Press soft key 4 to delete chosen date and all its entries.



## Data management

- Press soft key 4 to confirm or Soft key 1 to cancel.



### 11.5 Deleting a single test

- Turn rotary switch to select the data management position.

The primary field shows list of assets stored on the MTR

The secondary field shows the amount of entries, the total storage available are shown in the left hand field and the number of entries under the selected asset are shown in the right hand field.

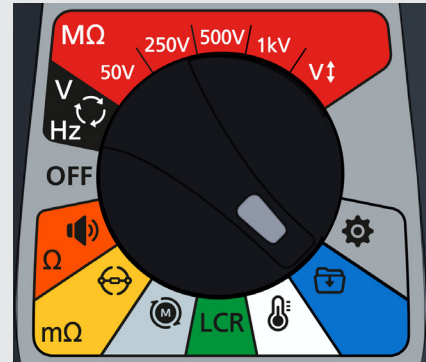

- Press soft keys 2 and 3 to scroll up and down through the asset list.



- Press the tick button (✓) to open the chosen asset and all its entries.





4. Press soft keys 2 and 3 to scroll up and down through the list.
5. Press the tick button (✓) to open the chosen date and all its entries.

The date opens out into colour - coded text (these are the same colours in use on the MTR105 rotary switch).

A number, in parenthesis, to the right hand side of the text line shows the number of results of that type of test saved to that asset, on that date. If no number is present, there are no results saved against this test type.



6. Press soft keys 2 and 3 to scroll up and down through the list.
7. Press the tick button (✓) to open to select the test type required.

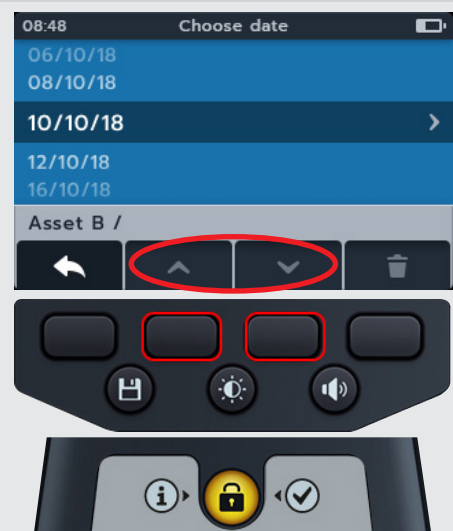

8. Press soft keys 2 and 3 to scroll up and down through the list of test types.



9. Press soft keys 2 and 3 to scroll up and down through the individual test list.
10. Press soft key 4 to delete the entry.

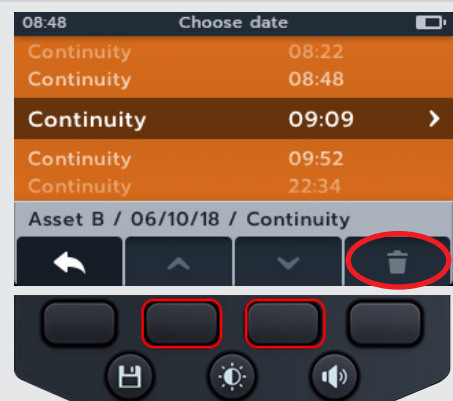

## Data management

11. Press soft key 4 to confirm or Soft key 1 to cancel.



## 11.6 Exporting entries to USB

1. Turn rotary switch to select the data management position.

The primary field shows list of assets stored on the MTR.

The secondary field shows the amount of entries and the total storage available are shown in the left hand field and the number of entries under the selected asset are shown in the right hand field.

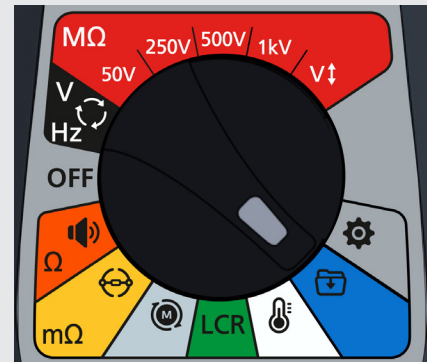

2. Connect a USB Memory stick to the MTR.

A USB type A socket is provided on the top of the MTR105 for transferring test results. The position is clearly marked with a USB symbol, the slider must be in the backward position.

**NOTE :** When a USB memory stick is recognised, the icon for soft key 1 will change from a plus (+) to the download symbol (↓).



3. Use soft keys 2 and 3 to scroll up and down through the asset list.

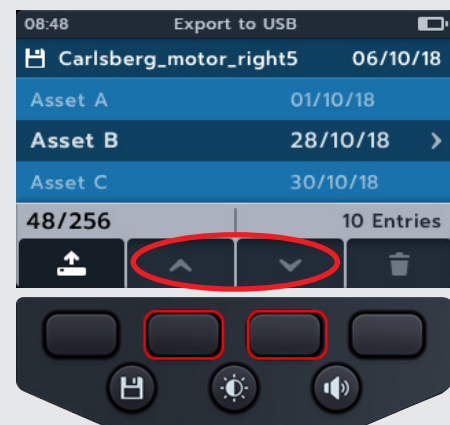

4. Press soft key 1 to begin upload.

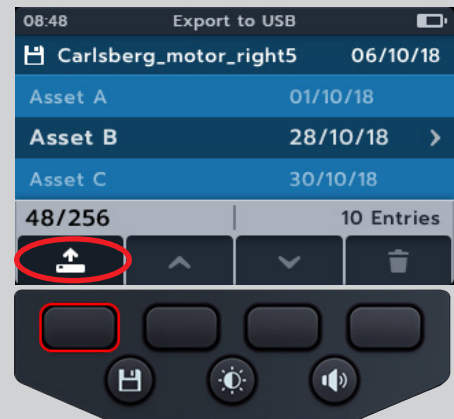

5. Press soft key 2 to upload the single asset ID and its measurement entries  
or  
Press soft key 3 to upload all saved assets and measurements  
or  
Press soft key 1 to cancel.

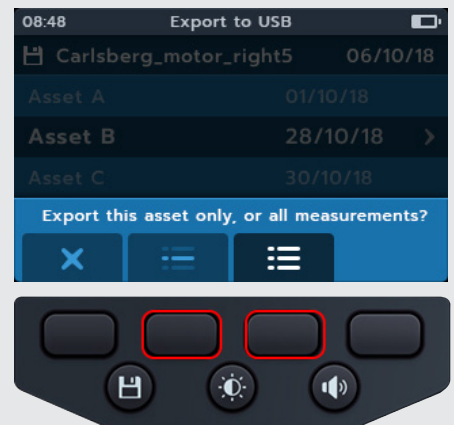

6. If matching names already exist in the storage device the user is asked if the MTR105 should overwrite them.

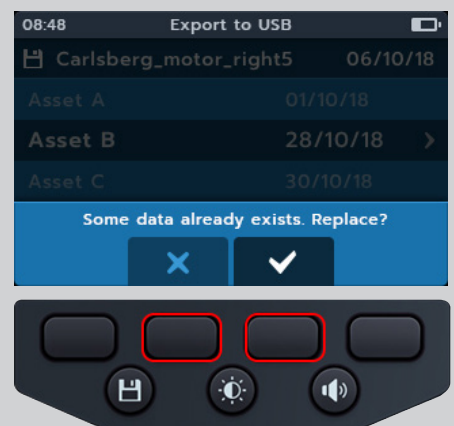

7. As the data is uploading, a message appears and blocks navigation in the secondary field. No other work can be carried out while uploading is in progress.



## Data management

- When the export is successful the MTR105 will notify the user.



## 12. Firmware update

Connect a USB flash drive to the MTR105 with the firmware update file in the root directory. The MTR105 will start the update process when the instrument is turned on if a firmware update is available.

1. Ensure the rotary switch is in the off position.
2. Plug the USB pen drive in to the USB slot at the top of the instrument.
3. The boot loader screen will be displayed when the instrument starts up.
4. Press [OK] to upgrade firmware or [TEST] to cancel.
5. The will progress through various stages.



```

2018-10-24 08:01
-- Firmware update--

Installation media found

Press [OK] to upgrade firmware
or [TEST] to cancel

Progress: --
  
```

```

2018-10-24 08:01
--Firmware Upgrade--

Copying update to internal
storage...

Progress: 50%
  
```

```

2018-10-24 08:01
--Firmware Upgrade--

Verifying update...

Progress: 50%
  
```

```

2018-10-24 08:01
--Firmware Upgrade--

Preparing to install new
firmware...

Progress: 50%
  
```

```

2018-10-24 08:01
--Firmware Upgrade--

Performing firmware upgrade...

Progress: 50%
  
```

6. When complete, return the range dial to off position.
7. Remove the USB.
8. Restart the MTR by turning the rotary switch to any test position.

```

2018-10-24 08:01
-- Success!--

Firmware upgrade complete!

Please remove the USB Drive
and restart the device

Progress: Done!
  
```

## Firmware update

9. The firmware update screen will display while the update in progress.
10. "Date and time is not set. Remind me later message" will appear. Press soft key 4 to continue.
11. The instrument will reboot after the update is complete.

**NOTE :** Steps 10 and 11 will only appear if the update file contains an update for the measurement processor, otherwise it will be skipped.



**NOTE :** If "Date and time is not set. Remind me later message" is received, Refer to 14.4.3 Date on page 78 and Refer to 14.4.7 Time on page 79 to update

## 13. Error and Warning Conditions

If an error code appears on the display follow the on screen instructions.

### 13.1 Failed export

1. If the export fails, the MTR105 will notify the user.  
This may be because the receiving USB device is faulty, is disconnected, full or in some other way fails.
2. The MTR will return to its previous screen.



### 13.2 Fuse Failure

If a fuse fails, no measurements can be carried out. A message will appear each time the user tries to run a test. Close the message by pressing tick button (✓). Refer to 15.4 Battery and Fuse Replacement on page 83

**NOTE :** A fuse failure warning could indicate a very low insulation resistance, check the leads connection and try again.

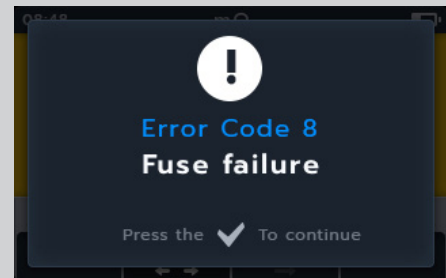

### 13.3 Battery Low

The battery is too low to perform a test.

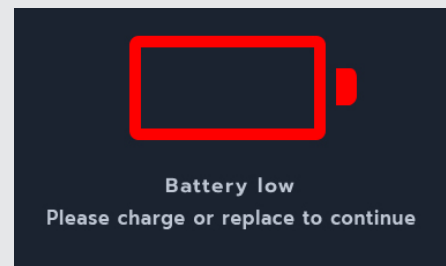

If the error code number is 1000 or higher the instruction on screen will suggest rebooting the instrument and if the problem persists, contact Megger.

For Megger contact details Refer to 18. Calibration, Repair and Warranty on page 89.

## 14. Settings

Various user settings can be adjusted, serial and software version numbers can be accessed in this section.

IR Test Settings	Continuity	General Settings	Language settings
DAR	Temperature compensation	Back-light timer	English
Insulation threshold		Battery technology	French
Lock		Date	Dutch
Temperature compensation		Instrument information	Spanish
Terminal lockout voltage		Key press notification	
Time insulation		Sleep timer	
Variable voltage		Time	
		Restore factory settings	
		Screen shots	
		Calibration	

### 14.1 Test settings navigation

All settings are available as listed in the chart above. The set up procedures are all similar to one-another.

1. Rotate the switch to the settings position.
2. Use Soft keys 1 and 4 to navigate between the top level setting categories.

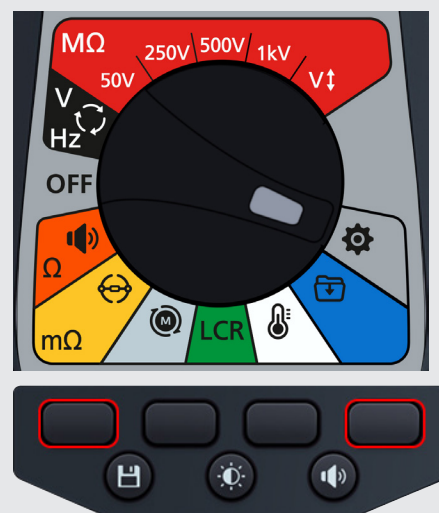

1. Scroll through the individual settings under each top level using soft keys 2 and 3.
2. Use the tick button (✓) to select a setting.
  - 2.1. This will toggle between the two options where a toggle key is displayed to the right hand side.

or

- 2.1. This will enter a sub menu if more than two options are available.

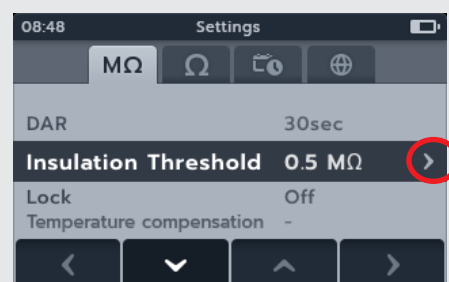
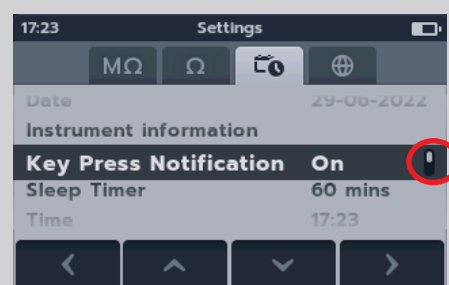



## 14.2 IR test settings

### 14.2.1 DAR Settings

There are two options available for DAR. Press the tick button (✓) to toggle between 15 seconds and 30 seconds.

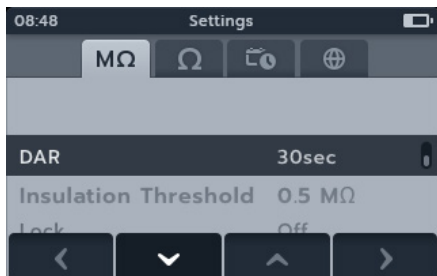

### 14.2.2 Insulation threshold

There are a number options available for Insulation threshold.

1. Select Insulation Threshold, press the tick button (✓).
2. Press soft key 2 and 3 to scroll through the options.
3. Press soft key 4 to accept the selected setting.
4. Press soft key 1 to cancel and return to the previous menu.



### 14.2.3 Lock

The lock setting enables the lock button for IR tests.

There are two options available for Lock. Press the tick button (✓) to toggle between on and off.

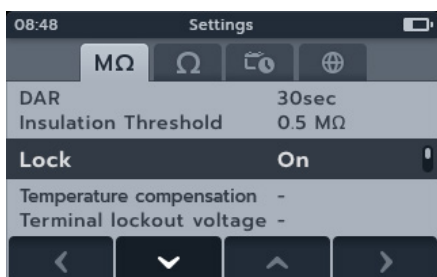

## Settings

### 14.2.4 Temperature compensation and motor class

1. Select temperature compensation press the tick button (✔).
2. Press soft key 2 and 3 to scroll through the options.
3. Press soft key 4 to accept the selected temperature setting and move to the motor class setting.
4. Press soft key 2 and 3 to scroll through the options.
5. Press soft key 4 to accept the motor class setting.
6. Press soft key 1 to cancel and return to the previous menu.

**NOTE :** C and F units can be changed by pressing soft key 1 in the Temperature test mode. Refer to 10. Temperature measurement on page 58

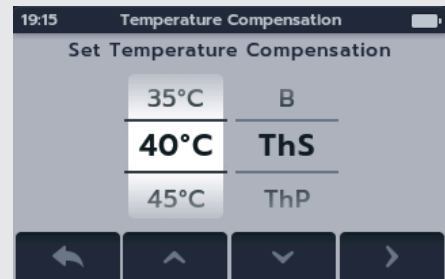

### 14.2.5 Terminal lock out

1. Select Terminal lockout press the tick button (✔).
2. Press soft key 2 and 3 to scroll through the options.
3. Press soft key 4 to accept the selected setting.
4. Press soft key 1 to cancel and return to the previous menu.

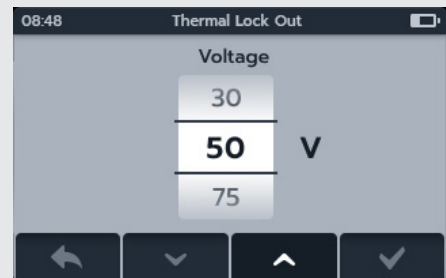

### 14.2.6 Timed Insulation

1. Select Timed insulation press the tick button (✔).
2. Press soft key 2 and 3 to scroll through the options.
3. Press soft key 4 to accept the selected setting.
4. Press soft key 1 to cancel and return to the previous menu.

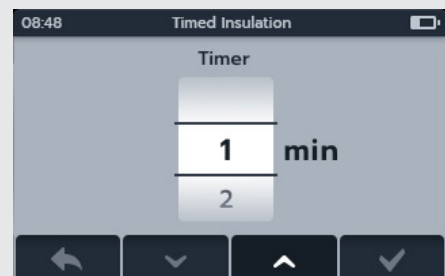

### 14.2.7 Variable Voltage

1. Select Variable voltage press the tick button (✔).
2. Press soft key 2 and 3 to scroll through the digits.
3. Press soft key 4 to accept the first digit and move to the next.
4. Press soft key 2 and 3 to scroll through the digits.
5. Press soft key 4 to accept the second digit and move to the next.
6. Press soft key 2 and 3 to scroll through the digits.
7. Press soft key 4 to accept the third digit and save the setting.
8. Press soft key 1 to cancel and return to the previous menu at any point.



## 14.3 Continuity Settings

### 14.3.1 Continuity temperature compensation

1. Select Temperature compensation press the tick button (✓).
2. Press soft key 2 and 3 to scroll through the options.
3. Press soft key 4 to accept the selected temperature setting and move to the winding material setting.
4. Press soft key 2 and 3 to scroll through the options.
5. Press soft key 4 to accept the winding material setting.
6. Press soft key 1 to cancel and return to the previous menu.

**NOTE :** C and F units can be changed by pressing soft key 1 in the Temperature test mode. Refer to 10. Temperature measurement on page 58

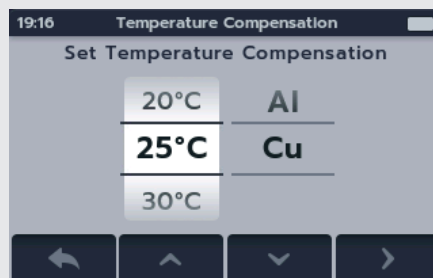

## 14.4 General Settings

### 14.4.1 Back-light timer

1. Select back-light timer press the tick button (✓).
2. Press soft key 2 and 3 to scroll through the options.
3. Press soft key 4 to accept the selected setting.
4. Press soft key 1 to cancel and return to the previous menu.

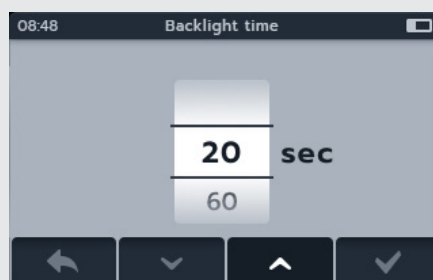

### 14.4.2 Battery Technology

1. Select Battery technology press the tick button (✓).
2. Press soft key 2 and 3 to scroll through the options.
3. Press soft key 4 to accept the selected setting.
4. Press soft key 1 to cancel and return to the previous menu.

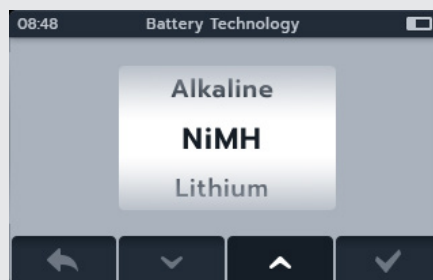

## Settings

### 14.4.3 Date

1. Select Date press the tick button (✓).
2. Press soft key 2 and 3 to scroll through the date format.
3. Press soft key 4 to accept the format and move to the day.
4. Press soft key 2 and 3 to scroll through the day.
5. Press soft key 4 to accept the day and move to the month.
6. Press soft key 2 and 3 to scroll through the months.
7. Press soft key 4 to accept the month and move to the year.
8. Press soft key 2 and 3 to scroll through the year.
9. Press soft key 4 to accept and save the date.
10. Press soft key 1 to cancel and return to the previous menu at any point.

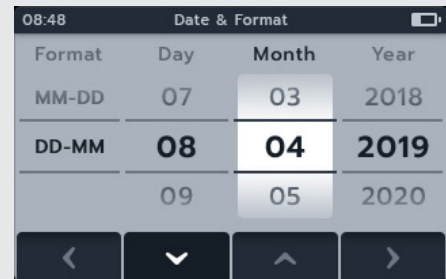

### 14.4.4 Instrument information

1. Select instrument information press the tick button (✓).
2. The instrument information will display.
3. Press soft key 1 to return to the previous menu.



### 14.4.5 Key Press Notification

There are two options available for Key Press Notification. Press the tick button (✓) to toggle between ON and OFF.

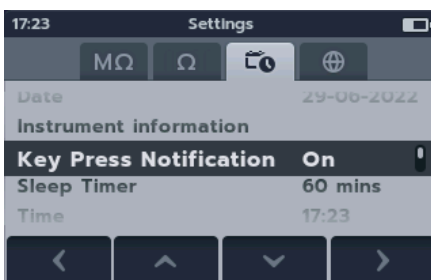

### 14.4.6 Sleep timer

1. Select Sleep timer press the tick button (✓).
2. Press soft key 2 and 3 to scroll through the options.
3. Press soft key 4 to accept the selected setting.
4. Press soft key 1 to cancel and return to the previous menu.

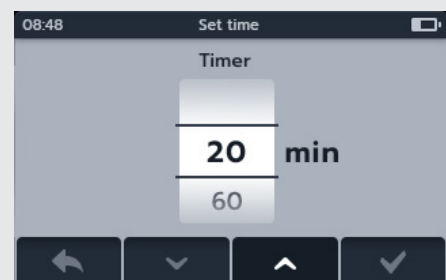

### 14.4.7 Time

1. Select Time press the tick button (✓).
2. Press soft key 2 and 3 to scroll through the date format.
3. Press soft key 4 to accept the format and move to the hour.
4. Press soft key 2 and 3 to scroll through the hour.
5. Press soft key 4 to accept the hour and move to the minute.
6. Press soft key 2 and 3 to scroll through the minute.
7. Press soft key 4 to accept and save the time.
8. Press soft key 1 to cancel and return to the previous menu at any point.

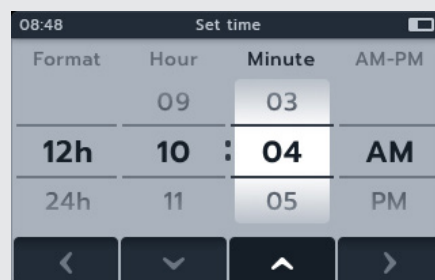

### 14.4.8 Restore factory settings

When the restore factory settings option is selected a pop screen will appear.

1. Press and hold the tick button (✓) to store the factory settings. This will restore settings and remove any saved data.  
or
2. Press soft key 1 to return to the previous menu. This will restore settings and keep any saved data.

After the MTR has restored factory setting:

3. Navigate through IR settings and check defaults.
4. Navigate through Continuity settings and check defaults.
5. Navigate to the date and time settings under the General settings tab Refer to 14.4.3 Date on page 78 and Refer to 14.4.3 Date on page 78
6. Navigate to Instrument Information and check information is correct

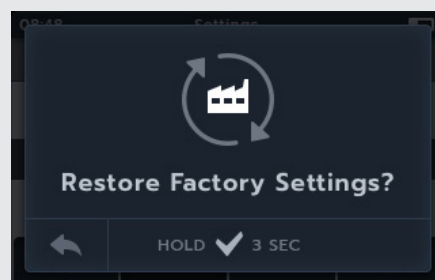

### 14.4.9 Screen shot

There are two options available for Key Press Notification. Press the tick button (✓) to toggle between ON and OFF.

#### 14.4.10 To take a screen shot

1. Plug a pen drive / USB into top MTR.
2. Toggle on screen shots in the setting.
3. Press brightness button at any point during use of the MTR to take screen shot. These are automatically saved to the attached pen drive.
4. To access the images, open the pen drive on a computer. 2 folders will display on the pen drive, a folder for results and a folder for screen shots. Open the screen shots folder to access the images.

**NOTE :** Screen shot settings will resets every time instrument is turned off

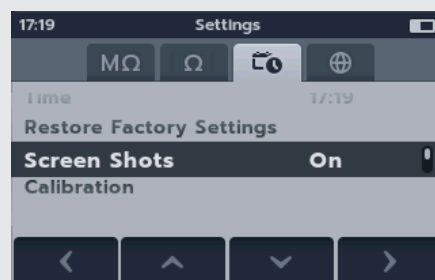

## Settings

### 14.5 Language settings

The languages set in the MTR105 are English, French, German and Spanish.

From the settings menu screen select the Language sub-menu using soft keys 2 and 3.

Select the required language using soft keys 2 and 3, the language changes immediately.

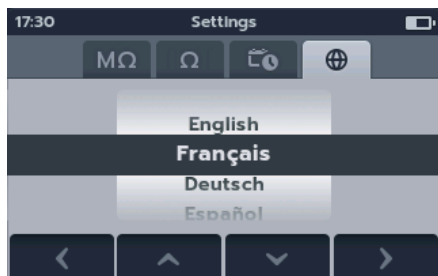

## 15. Maintenance

### 15.1 General Maintenance

- Test leads should be checked before use for damage and continuity.
- Ensure the unit is kept clean and dry after use.
- Close all covers when not in use.

### 15.2 Cleaning

1. Disconnect from mains power.
2. Wipe the instrument with a clean cloth dampened with either water or isopropyl alcohol (IPA).

### 15.3 Battery

**WARNING : Always set the instrument to Off and remove test leads before battery cells are removed or installed.**

**CAUTION : Old batteries must be disposed of in accordance with local regulations.**

**CAUTION : Only use approved batteries as defined below.**

Replacement battery types are: 6 x LR6 1.5 V Alkaline (AA), IEC HR6 1.2V NiMH or IEC FR6 1.5 V Lithium (LiFeS<sub>2</sub>), Refer to 16. Specifications on page 85.

Battery technology (battery type) can be selected between alkaline, NiMH or Lithium. When changing between battery types always ensure the correct type is selected in the settings menu, if this isn't done the battery reading will be incorrect.

To help maintain the health, reliability and longevity of the installed battery:

- Ensure if using rechargeable batteries they are fully charged before use.
- Store batteries in a cool, dry place. Battery cells can be damaged when exposed to heat.

#### 15.3.1 Battery status

**WARNING : Do not recharge Alkaline or Lithium battery cells.**

The battery condition icon is positioned at the top right hand corner of display. This icon is displayed at all times when the MTR105 is switched on. When running on battery, the icon will indicate state of charge, the icon will be filled in proportion to the state of charge.

When the battery is in a good state of charge the battery icon will be white and in a low state of charge the battery icon will flash.

When the battery is very low a large red battery icon will appear in the primary field with the message "**Battery low please charge or replace to continue**". No tests will be able to be performed but changes to settings and data handling can be carried out. The battery must be replaced (Alkaline/Lithium) or recharged (NiMH) before the MTR105 can be used.

When the battery is charging, it will show an animation of the battery from empty to full, then repeats. Once the battery is full, the animation stops.

The maximum charging time for NiMH batteries is 6 hours, normal charging time is approximately 4 hours.

### 15.3.2 12 V supply

When charging NiMH rechargeable battery cells, only use the power supply provided by Megger as an optional extra. Other power supplies will not function with the MTR105. The Megger power supply is designed to preserve the functions and accuracy of the MTR105.

### 15.3.3 Battery Charging

**WARNING : ONLY NiMH battery cells are rechargeable.**

When charging the MTR while the instrument is OFF, an animated battery will display across the screen to show charging is taking place. Once the battery is fully charged the screen will display a solid green battery.

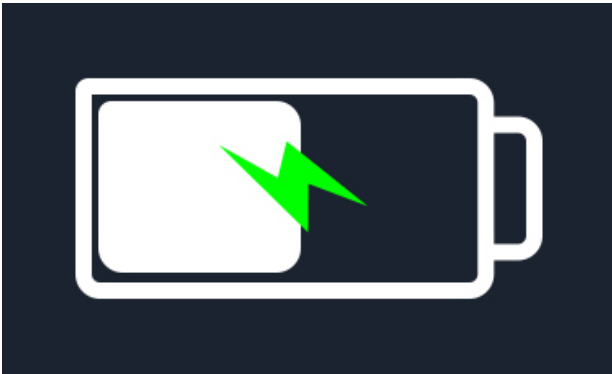

Battery charging



Battery fully charged

When charging the MTR while the instrument is OFF, an animated battery will display in the top right hand corner of the screen. While the MTR is charging a test can not be performed. If the test button is pressed the buzzer will sound. However the Data Management and Settings are fully accessible while the instrument is charging.

### 15.3.4 Battery error screens

#### Battery Low

The battery is too low to perform a test.

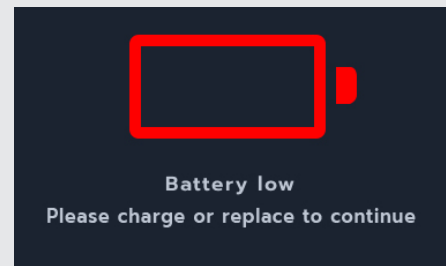

#### Charging Fault

A generic charging fault warning screen.

Turn off and disconnect the charger. Then reconnect and try again.

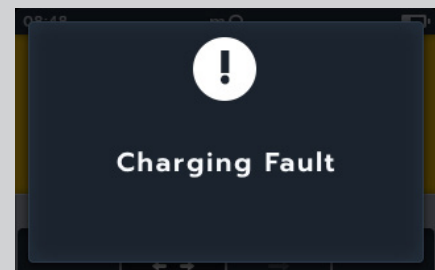



**Battery not chargeable**

The battery settings are not correct to allow battery charging.

1. Check the correct battery type is in the instrument, Refer to 15.4 Battery and Fuse Replacement on page 83
2. Check the battery settings are NiHM, Refer to 14.4.2 Battery Technology on page 77

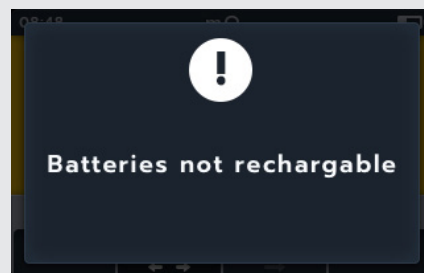

**15.4 Battery and Fuse Replacement**

**WARNING :** Remove all test leads before removing either the fuse or battery covers.

**CAUTION :** Battery cells should not be left in the instrument if remaining unused for an extended period.

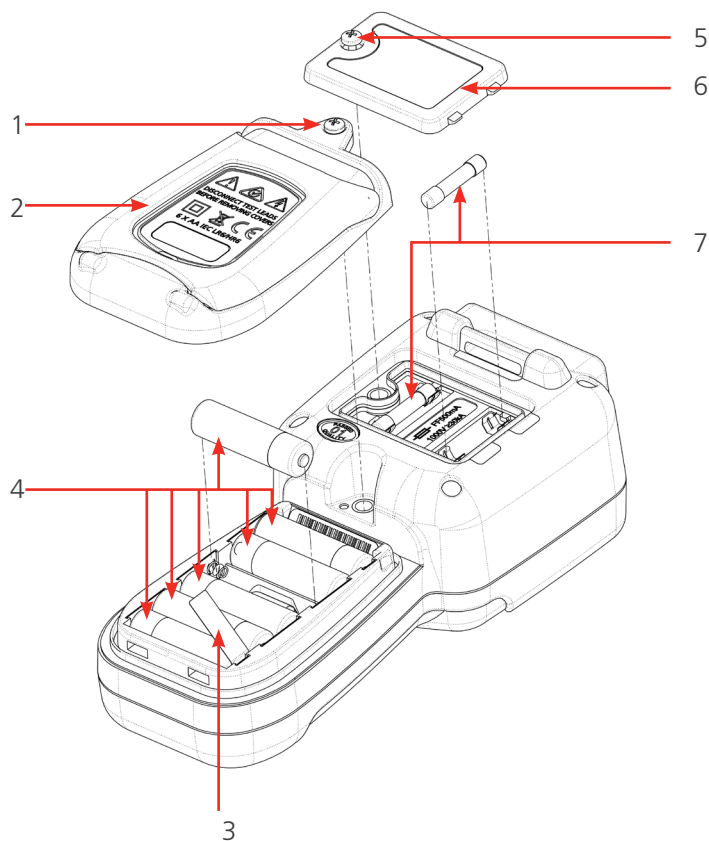

No.	Description	Quantity
1	Screw, Captive	1
2	Cover, Battery	1
3	Battery isolation tab	1
4	Battery	6
5	Screw, Captive	1
6	Cover, Fuses	1
7	Fuses	2

### 15.4.1 Replace battery cells and remove isolation tab

The battery cells are housed in the lower section of the MTR105, behind the rotary switch. Looking at the bACk of the instrument, the lower (battery) cover incorporates a stand and has the replacement cell types written on it.

**NOTE :** When replacing the battery cells, there is an approximate 3 minute window in which the MTR105 will retain the settings for date and time. If left longer these settings will have to be re-made. If using the MTR105 for the first time remove and discard the battery isolation tab (3).

1. Remove the test leads and ensure the MTR105 is switched off.
2. Slacken one captive cross-point screw (1) which is centred at the top of the cover.
3. Battery cover (2) will now lift away from the top.
4. Ease out of lugs at the bottom of the cover.
5. The six battery cells (4) can now be lifted out of the compartment.

**CAUTION :** Ensure the new cells are replaced in the correct polarity as indicated on the cells and battery compartment.

**CAUTION :** Ensure all battery cells are of the same type, do not mix Alkaline, NiMH and Lithium.

6. Replace all six battery cells (4).
7. Replace the battery cover (2) in reverse order to above.
8. Re-secure with screw (1).

### 15.4.2 To replace the fuses

**CAUTION :** Glass fuses must not be used.

The fuses are housed in the upper section of the MTR105, behind the display. Looking at the bACk of the instrument, the upper cover has a fuse symbol on it.

1. Remove the test leads and ensure the MTR105 is switched off.
2. Slacken one captive cross-point screw (5) from the left hand side of the top cover (marked fuses).
3. Fuse cover (6) will now lift away from the left hand side.
4. Ease out of lugs at right hand of the fuse cover.
5. The two fuses (7) can now be accessed and removed.

**CAUTION :** Ensure correct replacement fuses are used, 500 mA (FF) H. B. C. 30 kA minutes 1000 V (32 mm x 6 mm) refer to *Refer to 16. Specifications on page 85.*

6. Replace fuses (7) as required.
7. Replace the fuse cover (6) in reverse order to above.
8. Re-secure with captive screw (5).

**NOTE :** Fuses on the P terminals are not user replaceable. If these fail the instrument must be returned to Megger for repair.

## 16. Specifications

Specification	Detail
<b>Insulation resistance</b>	
Accuracy	Volts Accuracy 50 V 10 GΩ ±2% ±2 digits ±4.0% per GΩ 100 V 20 GΩ ±2% ±2 digits ±2.0% per GΩ 250 V 50 GΩ ±2% ±2 digits ±0.8% per GΩ 500 V 100 GΩ ±2% ±2 digits ±0.4% per GΩ 1000 V 200 GΩ ±2% ±2 digits ±0.2% per GΩ Operational Uncertainty: IEC61557-2
Polarisation index (PI):	10 minute / 1 minute ratio
Dielectric absorption ratio (DAR):	User configurable 15 s or 30 s t1 start time with t2 fixed at 60 s
Guard terminal performance	<5% error at 500 kΩ parallel circuit resistance with 100 MΩ load
Resolution	0.1 kΩ
Short circuit / charge current	2 mA +0% -50% (IEC61557-2)
Terminal voltage accuracy	-0% +2% ±2 V
Test current	1 mA at min. pass value of insulation to a max. of 2 mA max
Operation range	0.10 MΩ to 1.0 GΩ (IEC61557-2)
Leakage current display	0.1 μA resolution 10% (±3 digits)
Voltage display	±3% ±2 digits ±0.5% of rated voltage
<b>NOTE :</b> Above specifications only apply when high quality silicone leads are being used - as supplied with the instrument.	
<b>Continuity</b>	
Measurement	0.01 Ω to 1 MΩ (0 to 1000 kΩ analogue scale)
Accuracy	±3 % ±2 digits (0 to 99.9 Ω ) ±5% ± 2 digits (100 Ω - 500 kΩ)
Service Error:	IEC61557-4
Test current	200 mA (-0 mA +20 mA) (0.01 Ω - 4 Ω)
Polarity	Single polarity (Default) Dual polarity (configurable on setup)
Lead resistance	Null up to 9 Ω
<b>Capacitance</b>	
Range	0.1 nF - 1 mF accuracy ±5.0% ±2 digits (1 nF - 10 μF)
Accuracy (1 nF - 10 μF):	±5.0% ±2 digits
<b>Voltmeter</b>	
Range	DC: 0 - 1000 VAC: 10 mV - 1000 V TRMS sinusoidal (15 Hz - 400 Hz)
Accuracy	DC: ±2% ±2 digits (0 - 1000 V), AC: ±2% ±2 digits (10 mV - 1000 V TRMS) , Operational Uncertainty: IEC61557-1
Frequency range	15 - 400 Hz (0 - 1000 V)
Frequency resolution	0.1 Hz
Frequency accuracy	±0.5% (±1 digit)
Diode test accuracy:	±2% ±2 digits 0.01 V to 3.00 V
Display range:	0.00 V to 3.00 V

## Specifications

Temperature measurement and compensation		
Thermocouple	Type T (Type K and Type J)	
Thermocouple range	-20 °C to 200 °C (-4 °F - 392 °F)	
Instrument range	-20 °C to 1000 °C (-4 °F - 1832 °F)	
Instrument resolution	0.1 °C (0.18 °F)	
Instrument accuracy	±1.0 °C ±20 digits (±1.8 °F)	
Low resistance		
Test current	200 mA DC	
Range	1 mΩ to 10 Ω	
Resolution	0.01 mΩ	
Accuracy	±(0.25% rdg. ±10 digits)	
Inductance		
Instrument accuracy		
Range	Accuracy	Test Frequency
1 H	±(0.7 % +(Lx/10000) % +5 digits)	1 kHz
200 mH	±(1.0 % +(Lx/10000) % +5 digits)	120 Hz
20 mH	±(0.7 % +(Lx/10000) % +5 digits)	1 kHz
	±(2.0 % +(Lx/10000) % +5 digits)	120 Hz
2 mH	±(1.2 % +(Lx/10000) % +5 digits)	1 kHz
	±(2.0 % +(Lx/10000) % +5 digits)	1 kHz only
Results storage		
Storage capacity	256 motor results (date / time stamped)	
Data download	USB Type A (USB Mass Storage Device)	
Power		
Battery	6 x AA cells LR6 1.5 V Alkaline, FR6 1.5 V Lithium (LiFeS <sub>2</sub> ), HR6 1.2V NiMH (rechargeable option)	
Battery life	10 motors per day (complete suite of tests at 100 V into 100 MΩ) IEC61557-2 - test cycle, 1200 insulation tests with duty cycle of 5 sec testing on 25 sec standby @ 500 V into 0.5 MΩ IEC61557-4 test cycle, 1200 continuity tests with duty cycle of 5 sec testing on 25 sec standby on 1 Ω resistance	
Battery charging	Mains battery charger kit or 12 - 15 V DC vehicle charger	
Safety protection	IEC61010 CAT III 600 V	
EMC	Industrial IEC61326	
Temperature coefficient	<0.1% per °C up to 1 GΩ	
Environment		
Operating temperature range	-10 °C to 50 °C (14 °F to 122 °F)	
Storage temperature range	-25 °C to 50 °C (-13 °F to 122 °F)	
Humidity	90% RH at 40 °C (104 °F) max.	

Calibration temperature	20 °C (68 °F)
Maximum altitude	3000 m (9843 ft.)
IP rating	IP 54
<b>Physical</b>	
Display	Full LCD colour screen with user configurable bACK-light
Dimensions	228 x 105 x 77 mm (8.98 x 4.13 x 3.35 in)
Weight	0.93 kg (2.02 lbs)
Fuse	x2 500 mA (FF) 1000 V 32 x 6 mm ceramic fuse, high break capacity HBC, 30 kA minimum Glass fuses must not be installed.

**Operational Uncertainty, IEC61557**

Insulation

	Fiducial Value	A	E <sub>1</sub>	E <sub>2</sub>	E <sub>3</sub>	Operational Uncertainty
0.1 MΩ to 0.99 MΩ	0.1 MΩ	22 %	0	0	0	22 %
1 MΩ to 9.99 MΩ	1 MΩ	4 %	0	0	0	4 %
10 MΩ to 99.9 MΩ	10 MΩ	4 %	0	0	0	4 %
100 MΩ to 999 MΩ	950 MΩ	2.2 %	0	0	5.4 %	8.5 %

Continuity

	Fiducial Value	A	E <sub>1</sub>	E <sub>2</sub>	E <sub>3</sub>	Operational Uncertainty
0.1 Ω to 2 Ω	0.1 Ω	23 %	0	0	0	23 %

**Key to table:**

- A: Intrinsic uncertainty
- E<sub>1</sub>: Reference position ±90°
- E<sub>2</sub>: Supply Voltage
- E<sub>3</sub>: Temperature 0 °C to 30 °C
- IEC61557 -1, 61557-2 and 61557-4

## 17. Accessories and Equipment

### 17.1 Included Accessories

Item	Order No.
Hook strap assembly	
Soft pouch	
Temperature probe, T type CAT III 600 V	
IR lead set (comprising of):	
3 x Grabber Clips (Red, Black and Blue) CAT III 1000 V, CAT IV 600 V	
3 x 4 mm Test leads, 2 m, 1 end Right Angle 1 end straight (red, black and blue) CAT III 1000 V, CAT IV 600 V	
3 x Test probes (red, black and blue), long reach (100 mm), CAT III 1000 V, CAT IV 600 V	
Kelvin clip lead set CAT III 600 V (comprising of):	
2 x Kelvin Clip leads, 2 meters, 4 mm Right Angled Connectors (4), Single (2-core) cable.	
MTR105 calibration certificate	
USB memory stick	

### 17.2 Optional Accessories

Item	Order No.
Mains charger kit	1007-464
Hook strap assembly	1012-068
Soft pouch	1012-063
Kelvin probe lead set CAT III 600 V	1011-929
Kelvin probe pins (pack of 4)	1012-064
Kelvin clip lead set CAT III 600 V	1011-928
Grabber clip lead set CAT III 1000 V, CAT IV 600 V	1012-069
Test probe set, long reach CAT IV 600 V	1012-066
Test probe set, long reach, CAT II 1000 V	1012-065
Temperature probe, T type CAT III 600 V	1012-067
MTR105 calibration certificate	1012-173
MTR105 UKAS calibration certificate	1012-172
SP5 remote probe accessory	1007-157

## 18. Calibration, Repair and Warranty

**NOTE :** For calibration of LCR functions Refer to 9.5 LCR Calibration on page 56.

Megger operate fully traceable calibration and repair facilities to make sure your instrument continues to provide the high standard of performance and workmanship that is expected. These facilities are complemented by a worldwide network of approved repair and calibration companies, which offer excellent in-service care for your Megger products.

For service requirements for Megger instruments contact:

Megger Limited Archcliffe Road Dover Kent CT17 9EN U. K.  Tel: +44 (0) 1304 502 243 Fax: +44 (0) 1304 207 342	OR	Megger 400 Opportunity Way Phoenixville PA 19460 USA  Tel: +1 610 676 8579 Fax: +1 610 676 8625
---	----	--

### 18.1 Return procedure

**WARNING : Remove the battery cells before shipping this instrument.**

UK and USA Service Centres

- When an instrument requires recalibration, or in the event of a repair being necessary, a Returns Authorisation (RA) number must first be obtained from one of the addresses shown above. The following information is to be provided to enable the Service Department to prepare in advance for receipt of your instrument and to provide the best possible service to you:
  - Model (for example, MTR105).
  - Serial number (found on the display under settings, device information, or on the rear cover and by the batteries or on the calibration certificate).
  - Reason for return (for example, calibration required, or repair).
  - Details of the fault if the instrument is to be repaired.
- Make a of the RA number. A returns label can be emailed or faxed to you if required.
- Pack the instrument carefully to prevent damage in transit.
- Before the instrument is sent to Megger, freight paid, make sure that the returns label is attached or that the RA number is clearly marked on the outside of the package and on any correspondence. Copies of the original purchase invoice and packing should be sent simultaneously by airmail to expedite clearance through customs. In the case of instruments which require repair outside the warranty period, an immediate quotation can be provided when obtaining the RA number.
- Track the progress on line at [www.megger.com](http://www.megger.com).

## 19. Decommissioning

---

### 19.1 WEEE Directive

The crossed out wheeled bin symbol placed on Megger products is a reminder not to dispose of the product at the end of its life with general waste.

Megger is registered in the UK as a Producer of Electrical and Electronic Equipment. The Registration No is WEE/ HE0146QT.

For further information about disposal of the product consult your local Megger company or distributor or visit your local Megger website.

### 19.2 Battery disposal

The crossed out wheeled bin symbol placed on a battery is a reminder not to dispose of batteries with general waste when they reach the end of their usable life.

The battery, is located under the battery cover on the bACk of the instrument. To remove the battery follow the instructions in *Refer to 15.4 Battery and Fuse Replacement on page 83*.

For disposal of batteries in other parts of the EU contact your local Megger branch or distributor.

Megger is registered in the UK as a producer of batteries (registration No.: BPRN00142).

For further information see [www.megger.com](http://www.megger.com)



## Local Sales office

---

Megger Limited  
Archcliffe Road  
Dover  
Kent  
CT17 9EN  
ENGLAND  
T. +44 (0)1 304 502101  
F. +44 (0)1 304 207342

## Manufacturing sites

---

Megger Limited  
Archcliffe Road  
Dover  
Kent  
CT17 9EN  
ENGLAND  
T. +44 (0)1 304 502101  
F. +44 (0)1 304 207342

Megger GmbH  
Weststraße 59  
52074 Aachen  
T. +49 (0) 241 91380 500  
E. info@megger.de

Megger USA - Valley Forge  
400 Opportunity Way  
Phoenixville  
PA 19460  
USA  
T. +1 610 676 8500  
F. +1 610 676 8610

Megger USA - Dallas  
4545 West Davis Street  
Dallas TX 75237  
USA  
T. 800 723 2861 (USA only)  
T. +1 214 333 3201  
F. +1 214 331 7399  
E. USsales@megger.com

Megger AB  
Rinkebyvägen 19, Box 724,  
SE-182 17  
DANDERYD  
T. +46 08 510 195 00  
E. seinfo@megger.com

Megger USA - Fort Collins  
4812 McMurry Avenue  
Suite 100  
Fort Collins CO 80525  
USA  
T. +1 970 282 1200

**This instrument is manufactured in the United Kingdom.**

**The company reserves the right to change the specification or design without prior notice.**

**Megger is a registered trademark**

**The Bluetooth<sup>®</sup> word mark and logos are registered trademarks owned by Bluetooth SIG, Inc and is used under licence.**